

# Smart Agriculture



## Smart Cities

APPLICATION GUIDE



**muRata**  
INNOVATOR IN ELECTRONICS



# Introduction

## Exploring Emerging Smart City Opportunities

- Dynamics such as a growing population, an increasing elderly demographic, greater urbanization, plus rising pollution are all putting acute pressures on people's everyday lives. Society must look at what can be done to help enrich modern living conditions and make the world a better place for future generations to inhabit. This can be achieved by utilizing smart technology.
- Across the globe, a multitude of smart city projects are now under way. These are enabling air quality issues to be tackled and traffic congestion to be addressed. They are making public transport more efficient, augmenting industrial processes, boosting farming production, enhancing healthcare services and making homes more comfortable and secure.
- Through smart city initiatives, municipal governments and utility companies are improving the services that they provide, while also reducing their capital and operational expenditure.
- It must be acknowledged that every smart city implementation is distinct. Each will have different aspects that need to be considered and present its own specific problems to overcome. This means that having access to a broad range of different electronic components will be required in order to develop fully effective solutions.
- Murata has already built up a strong reputation in the various application areas that this guide discusses. There are a broad selection of Murata products that can be specified for smart city deployment, with details being given in the following pages.

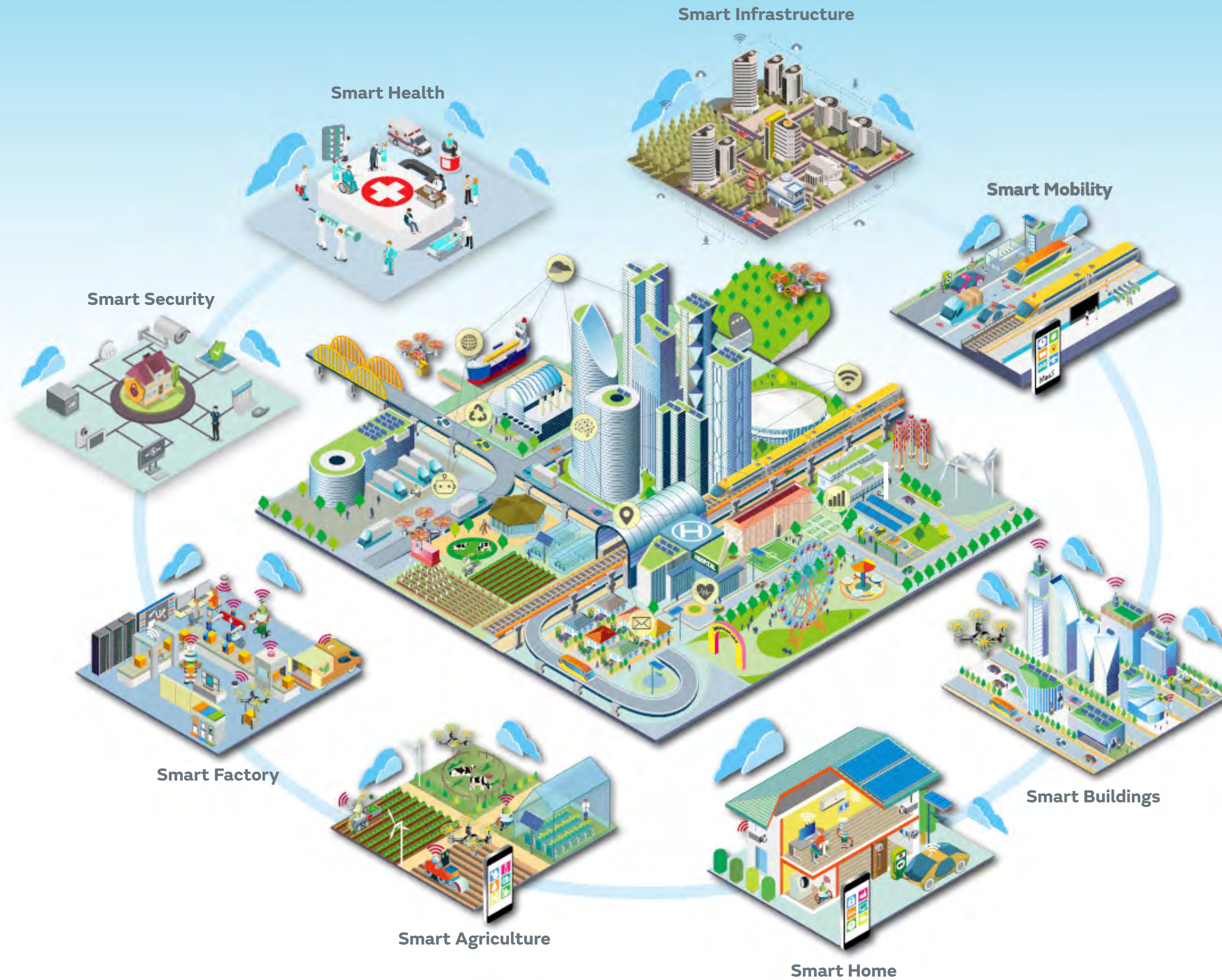

Contact us



Follow us



Subscribe

**muRata**

INNOVATOR IN ELECTRONICS



# Overview

## Global Smart Cities Market Expanding Rapidly

- Projections from industry analysts Frost & Sullivan estimate that the global smart cities market will experience a compound annual growth rate (CAGR) of approximately 19% over the coming years.
- There has already been widespread investment in smart city projects throughout Europe, and further projects are currently being planned. Among the cities where most activity has been seen are Barcelona, London and Amsterdam.
- Among the most important features of smart cities are environment monitoring, surveillance, resource management, more efficient farming, manufacturing with higher productivity levels and greater efficiency of healthcare systems. These will help to improve residents' quality of life, as well as enhancing the performance of public services.

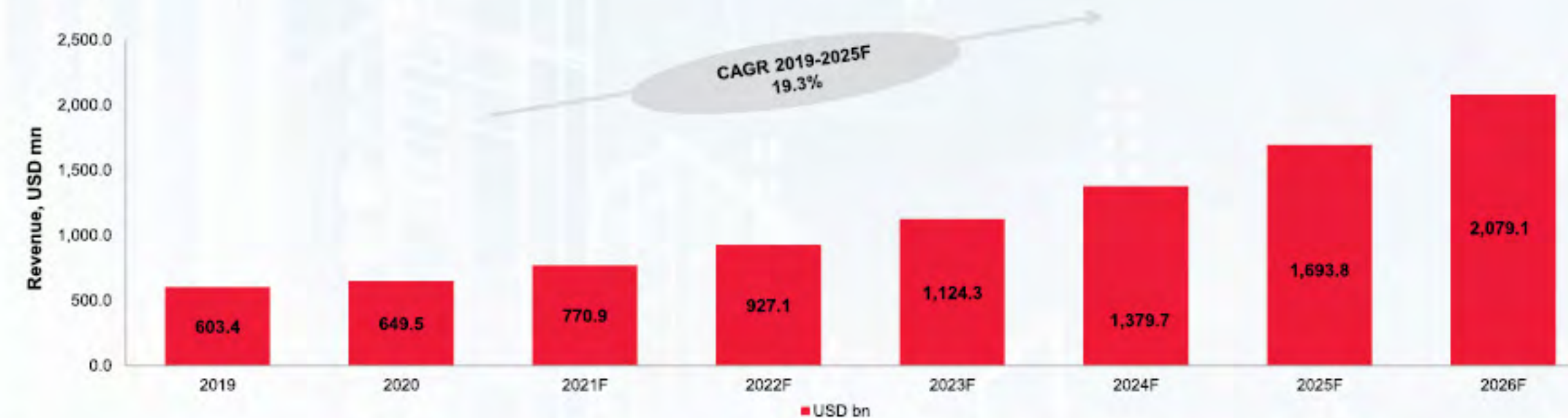

Smart Cities Market, in USD Billion, Between 2019-2026F





# Rapid Urbanization

## Emerging Mega Trends

**62.5%**

### Urban Population

According to Statista, approximately 62.5% of the population will be living in the cities by 2050, as compared to 51% in 2010. Figures compiled by the World Health Organization (WHO) give very similar projections.

**43 megacities**

### Megacities

A study published by the United Nations (UN) states that, by 2030, the world will have a total of 43 megacities (i.e. ones with more than 10 million inhabitants). Most of these will be situated in developing regions of the world.

- Statista states that North America is the most urbanized continent currently, with 82.0% of its population living in cities. Latin America and the Caribbean were also reported as having a high degree of urbanization - as about 79.0% of the population reside in cities.
- Europe is ranked third in terms of degree of urbanization. Here 75.0% of the population live in urban areas.
- Many countries in Asia and Africa will face challenges in meeting the needs of their rapidly growing urban populations. This will be most noticeable in relation to housing, transportation, energy systems and other infrastructure, as well as for employment and basic services (such as education and healthcare).

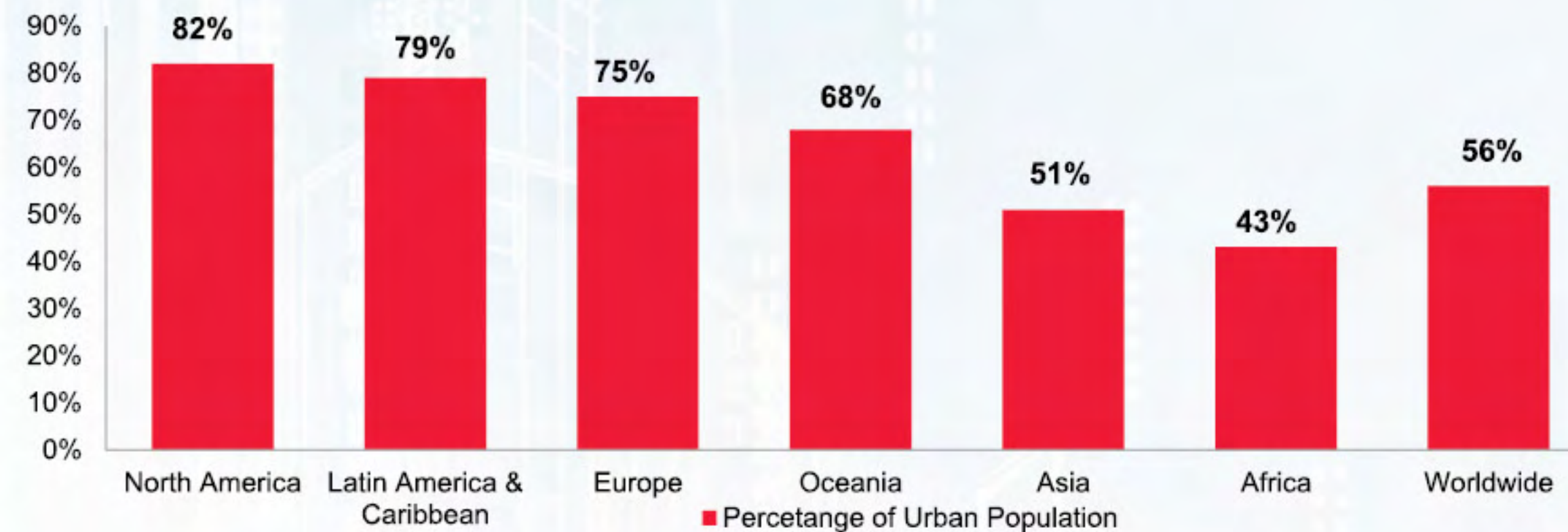

Degree of Urbanization by Continent, 2020





# Internet of Things

## Emerging Mega Trends



### IoT Devices Today

In 2021, there were more than 10 billion active IoT devices.



### IoT Devices in the Future

It is expected that the number of IoT devices in operation will surpass 25.4 billion by 2025.



### IoT Hardware

The most-notable change to the IoT sector will be around the emergence of new software that allows for connection between devices. Hardware still accounts for 30.0% of the total value of IoT technology, although trends suggest its global market value is decreasing.

- The global IoT market is expected to reach a value of USD 1,512.8 billion by 2026 (from USD 683.9 billion in 2019). That represents a CAGR of 12.0%.

- With the development of new wireless networking technologies, the emergence of advanced data analytics, a reduction in the cost of connected devices and increased cloud platform adoption, the IoT market is expected to keep growing at a considerable rate.

- Based on forecasts of over 7.33 billion mobile users by 2023 and more than 1.1 billion connected wearable devices by 2022, show the IoT is destined to become one of the smartest collective and collaborative systems in human history.

- Transportation is getting smarter too. Insider Intelligence projects that in the US connected cars will constitute 97.0% of the total number of registered vehicles by 2035.

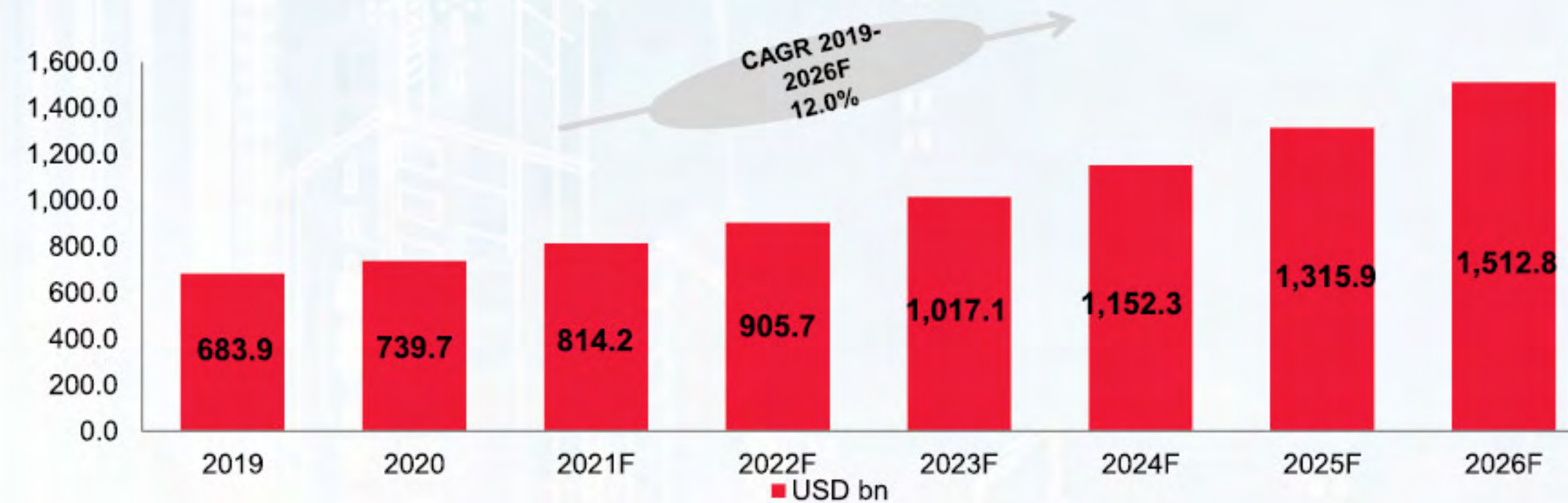

Global IoT Market, in USD Billion, Between 2019-2026F





# 5G

## Emerging Mega Trends

**35 Gb**

### Phone Usage

The Ericsson Mobility Report states that the monthly global average data usage per smartphone now exceeds 10GB, and this is forecast to reach 35GB by the end of 2026.

**USD 1.0 bn**

### Horizon Project

Governments are investing in 5G in a bid to make hyper connected public services. For example, China has allotted over USD 30 billion to 5G research and development for the next five years. The European Commission (EC) has earmarked USD 1 billion to 5G as part of its Horizon 2020 project.

**350%**

### 5G Coverage

In 2021, 5G coverage grew by a staggering 350.0% to cover 1,336 cities. As a result, 30.0% of the world's countries now have 5G coverage. A year earlier, there were only 378 cities that had 5G.

- According to estimates from Ericsson's latest edition of its Mobility Report, the number of 5G smartphone subscriptions worldwide passed 500 million in 2021, more than doubling the figure for 2020. In 2022, 5G subscriptions are on target to reach 1.1 billion and this is expected to climb to 3.4 billion during 2026.

- 5G-led ubiquitous sensor networks will be at the foundation of smart city development. The unique ability of 5G networks to meet differentiated smart city needs will be pivotal in enabling greater collaborative intelligence.

- 5G technology can address the needs of smart healthcare. Through this, it will be possible for fair, accessible and inclusive healthcare reform to be promoted.

- North America had an 89.3% share in LTE connections in Q4 of 2020. It was followed by Oceania, East and Southeast Asia at 78.4%, Western Europe at 69.73, then Latin America and the Caribbean at 57.59%.

- In Europe, the total benefit of a full 5G deployment for open innovation platforms will cost USD 53.2 billion. However, the benefit in doing so will amount to USD 240.0 billion.

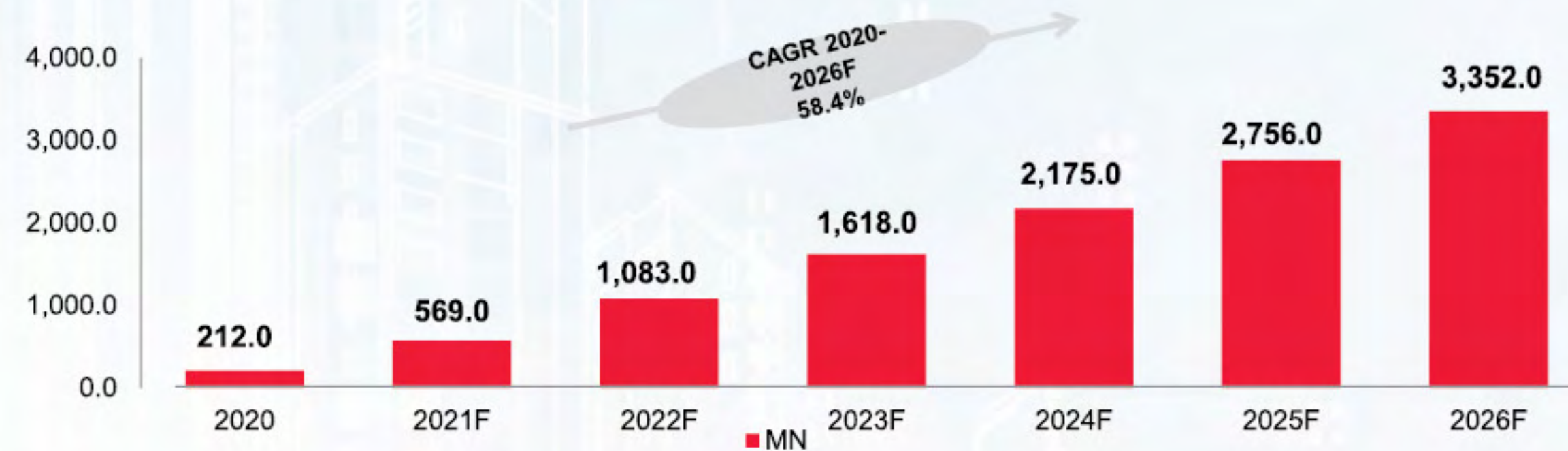

Global 5G Subscription, in Millions, 2020-2026F



# Technological trends

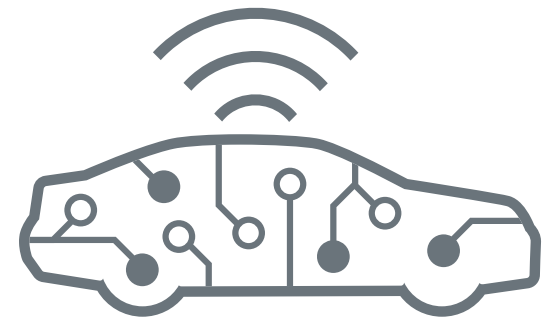

## Autonomous Vehicle

These will include drones delivering packages to various locations, service machines doing cleaning and restoration services, plus automated 'personal assistants' helping employees get more done faster and with greater precision.

They will be driven by the improved capabilities from chip vendors (e.g. Qualcomm, Intel, MediaTek, Broadcom, etc.), advanced and more abundant sensors (e.g. visual-based sensors, ultrasonic, touch, smell, LiDAR, etc.), high bandwidth low latency connections (e.g. 5G, Wi-Fi 6), and enhanced AI capabilities/algorithms (e.g. navigation, point-to-point scheduling, visual interpretations, etc.).



## Private 5G

5G private networks are isolated either physically or virtually from public networks, using different hardware, virtual machines or network-slices.

Additionally, 5G private networks will further transform the factory floor. The three main components of 5G - enhanced mobile broadband (eMBB), massive IoT and enhanced ultra-reliable low latency communications (eURLLC) - are utilized to connect a diverse set of devices in a factory. The 2020 3GPP Release 16 brought advanced support for 5G non-public networks (NPN), their defining characteristic being a network for private usage and not accessible to public users' navigation, point-to-point scheduling, visual interpretations, etc.)



## DSA

Domain-specific architectures (DSAs) will represent the future of artificial intelligence (AI) inference. They will enable adaptable hardware which can be customized, so that workloads may run at the highest possible efficiency. In 2022, AI inferencing will continue to move away from fixed silicon approaches and towards DSAs, helping to eliminate AI productization challenges. With this new ease of programming, FPGAs and adaptable SoCs will continue to become more accessible for hundreds of thousands of software developers and AI scientists - making them the hardware solution of choice for next generation applications.



## Cloud Computing

The smart cities that will be so central to our future society will be underpinned by 5G communication, but also reliant on a number of other technologies if they are to function effectively. This is where cloud computing comes in. Approximately 6 billion people are predicted to live in smart cities by 2045 - that will mean significant computing capacity will be necessary. Cloud technology will provide the digital infrastructure for smart cities, functioning as a storage and analysis system for the data used in everything from autonomous vehicles to farming.



Contact us



Follow us



Subscribe



# Addressing the Challenges

## What is required and what Murata can offer

- At the foundation of any form of smart city deployment will be the ongoing collection of large amounts of data. Through the analysis of this data, the various different services involved can be planned in ways that are the most efficient, environmentally friendly, responsive and cost-effective. Compiling all of this data calls for mass distribution of IoT devices.
- With the IoT devices being placed in locations that are difficult to reach, there is little or no opportunity for technicians to return to them once they have been deployed - the logistical costs would simply be too high. It is therefore vital that such hardware is built from high reliability components that will support long-term trouble-free operation. This will mean that the need for replacement or maintenance work can be avoided.
- In addition, plug-and-play solutions should ideally be chosen. This will minimize the set-up period and the engineering effort involved in configuration, calibration, etc. Smart city services can then be brought on-line in a much shorter time frame, meaning that citizens will see the benefits sooner.
- Murata offers a broad selection of relevant components parts, enabling customers to choose the best fit for their specific application requirements without having to make compromises. These are straightforward to install and deliver prolonged working lifespans.



Contact us



Follow us



Subscribe

**muRata**  
INNOVATOR IN ELECTRONICS



# Smart Agriculture

## Using technology to solve future food shortage problems

- With a continuously increasing global populace, combined with diminishing land reserves available for farming and access to a limited workforce, food production is reaching a state of crisis. Efforts must be made to ensure that supply can keep up with demand.
- Smart agriculture will see data captured from numerous sensor nodes - enabling various different ambient parameters (relating to the air, soil, light levels, etc.) to be monitored, as well as updates on the local weather conditions.
- Because this hardware will be situated in an outdoor environment, it will need to be rugged enough to withstand extreme temperature variations, exposure to wind and rain, etc. Otherwise there will be a risk of malfunctions occurring.
- Crucial to the success of this monitoring work is 'barrier free' implementation. Use of wireless rather than wireline communication offers much greater convenience. It will be easier to add new nodes as they are required, or make changes to network arrangements.
- Murata wireless modules are highly robust and reliable. They represent a very lower total cost of ownership, as the need for repair and maintenance work is lessened considerably. These modules are also compact and lightweight, enabling them to attend to AGV/drone applications.





# Soil sensor

## Challenges in agricultural environments

The Murata soil sensor has been developed to continuously measure the conditions of many different agricultural environments.

The three-in-one package includes sensor elements for accurately determining electrical conductivity (EC), temperature, and moisture in terms of volumetric water content (VWC). As a result, this device is capable of measuring all three parameters simultaneously, either in soil or underwater. Specifically, the industry's first-ever nine-electrode EC sensor has multiple measuring patterns that help to eliminate uncertainty.

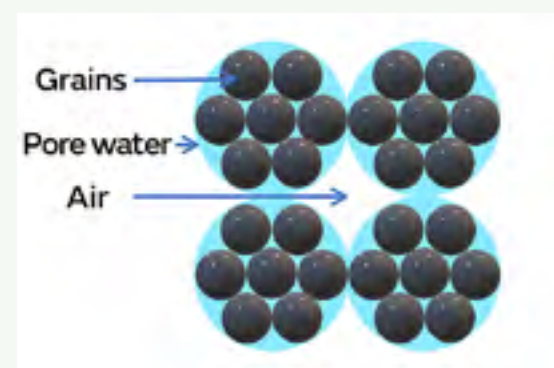
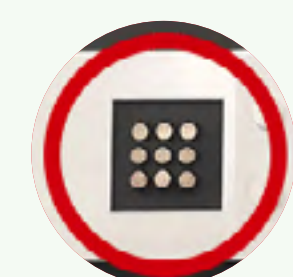
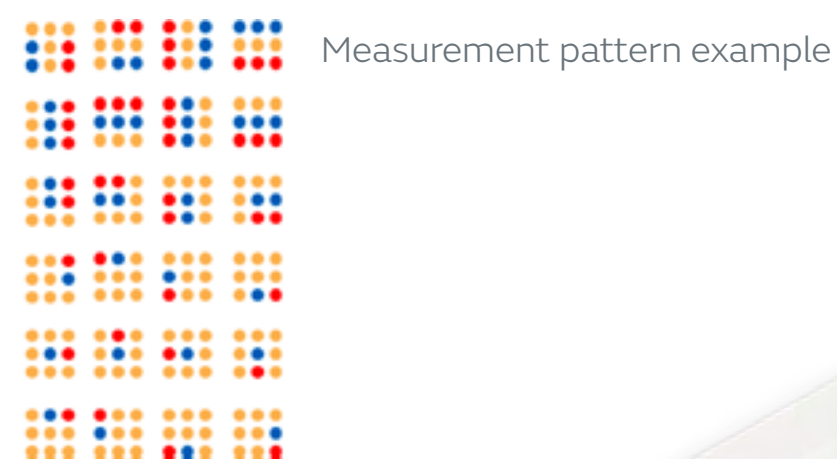

## FEATURES

- **EC sensor**
  - Electrical conductivity depends on contained anion/ cation amount. (NO<sub>3</sub>, NH<sub>4</sub>, H<sub>2</sub>PO<sub>4</sub>, K, Ca, Mg, NaCl etc..)
- **Temperature sensor**
  - Temp. in the soil and water environment.
- **Moisture sensor**
  - Measure the electric permittivity, translate to VWC.

## PRODUCT SPECIFICATIONS

- **Supply Voltage:** 3.0-6.5 V
- **Active current:** 50 mA(max)
- **EC range:** 0-5.0 dS/m
- **EC accuracy:** ±3 - F.S.
- **Moisture range:** 0-60 %VWC
- **Moisture accuracy:** ±3 % F.S.
- **Temperature range:** -20°C-70°C
- **Temperature accuracy:** ±1.1 °C
- **Waterproof:** IP68
- **Interface:** UART, RS232E, RS485, SDI-12
- **Cable length:** 3m@UART, 10m@RS232E, 300m@RS485 (Verified cable length)

## ADVANTAGES

- **Simple interface:** Three sensors in one package
- **High accuracy moisture measurement:** No effect of saline and temp
- **High accuracy EC:** Certainty and Ability for dry soil
- **Rugged and waterproof structure:** Hardness, IP68
- **Suitable for wireless transmission:** Low power consumption
- **Multi interface:** UART, RS232E, RS485, SDI-12
- **Wireless system:** 2.4GHz original protocol, BLE

# Smart Agriculture Sensors

## APPLICATIONS

- **Long term soil condition monitoring for Agriculture.**
- **Agriculture irrigation system control**
  - Long term river and pond water condition monitoring
  - Aquaculture pond water condition control
  - Powder dry monitoring and control
  - Soil and water environment research

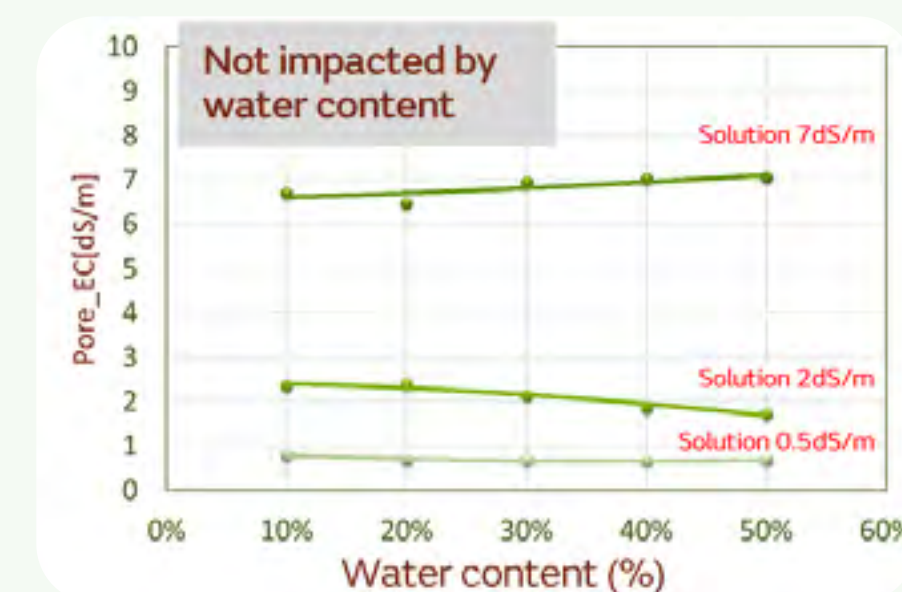
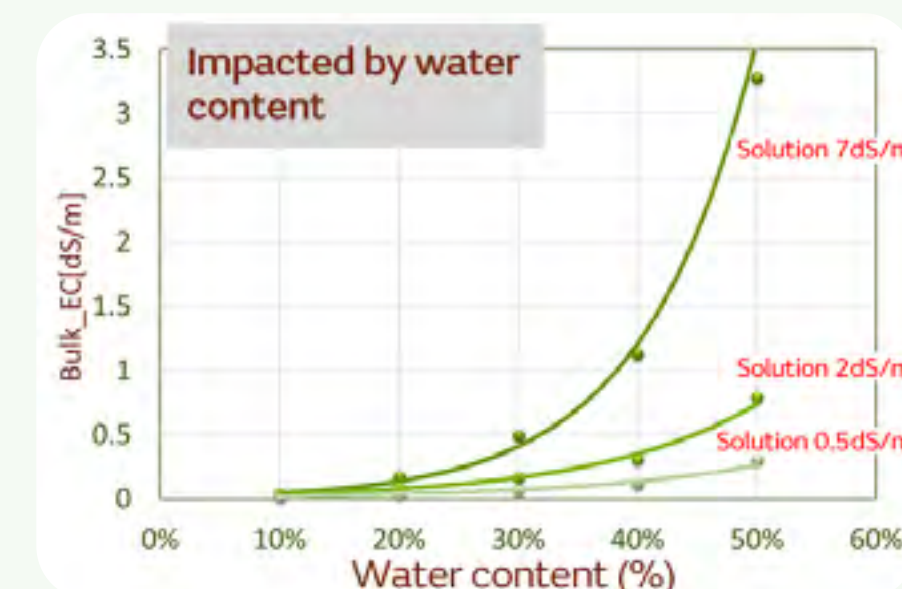

Contact us



Follow us



Subscribe





# NDIR CO2 sensor

## Long-term stability using auto-calibration

Murata's CO2 sensor is a product that exhibits long-term stability and high measurement accuracy. Its maintainability is improved through an automatic calibration feature incorporated. This is based on a unique calibration curve algorithm and a dual wavelength non-dispersive infrared (NDIR) system. One wavelength is for measurement and the other for reference.

IMG-CA0014-00  
67 x 92 x 20mm



### FEATURES

- **Low influence of other gases by NDIR principle**
- **Excellent temperature characteristics and high accuracy**
- **Excellent long-term stability and high reliability by automatic calibration**

## Smart Agriculture Sensors

### PRODUCT SPECIFICATIONS

- **Operating temperature:** 0 to 50 °C
- **Storage temperature:** -20 to 50 °C
- **Measurement range:** 0 to 2000ppm, 0 to 3000ppm
- **Accuracy:** ± (50ppm+5% of reading)  
Typ. ± (30ppm+2.5% of reading)
- **Long-term stability (drift):** ±50ppm/Year @ 1000ppm
- **Power input:** AC/DC 24V, DC12V
- **Peak power consumption:** Avg. 0.5W/Max. 2.0W
- **Output interface:** Analog 0 to 5V
- **Measurement interval:** 5s
- **Dimensions:** 67x92x20mm

### Long-term test in building

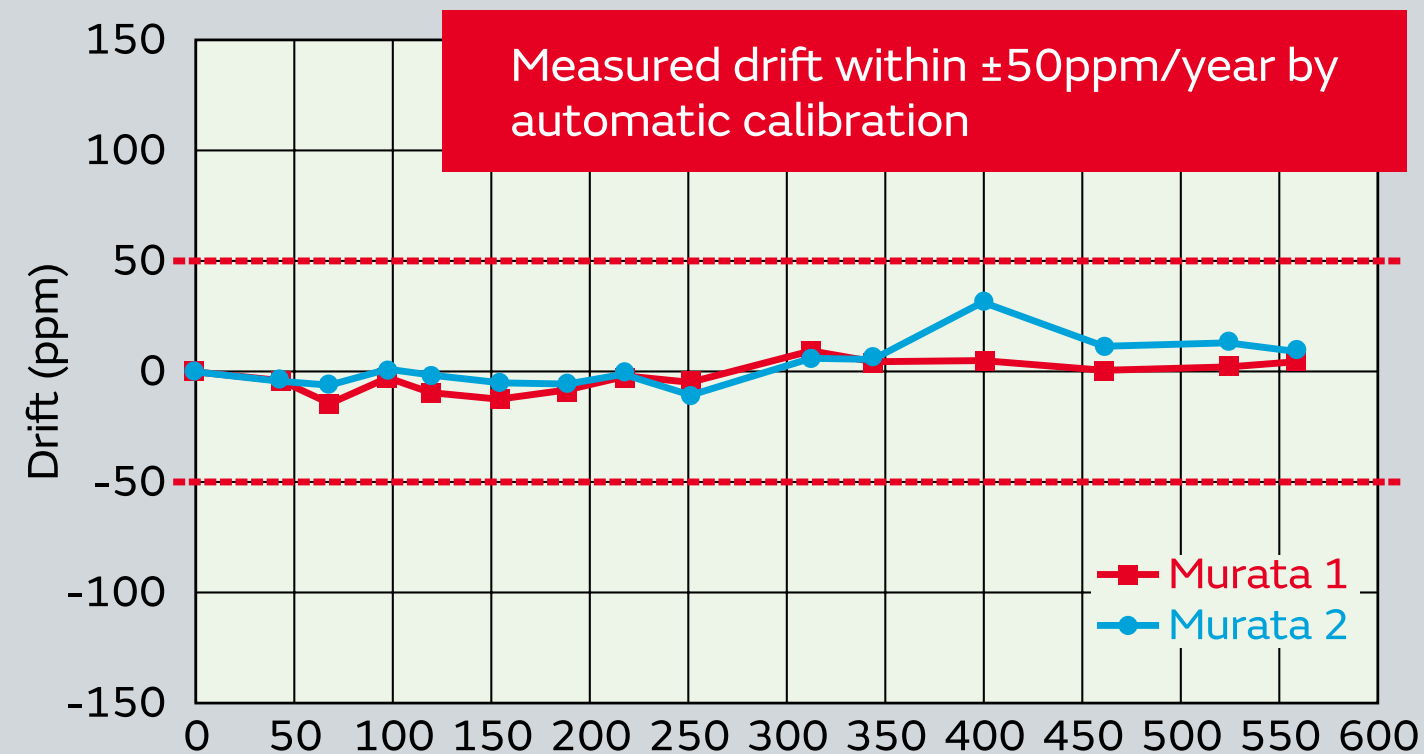

Tested by TODA Corp.  
Tested by standard gas @ 1000ppm

### Measurement accuracy

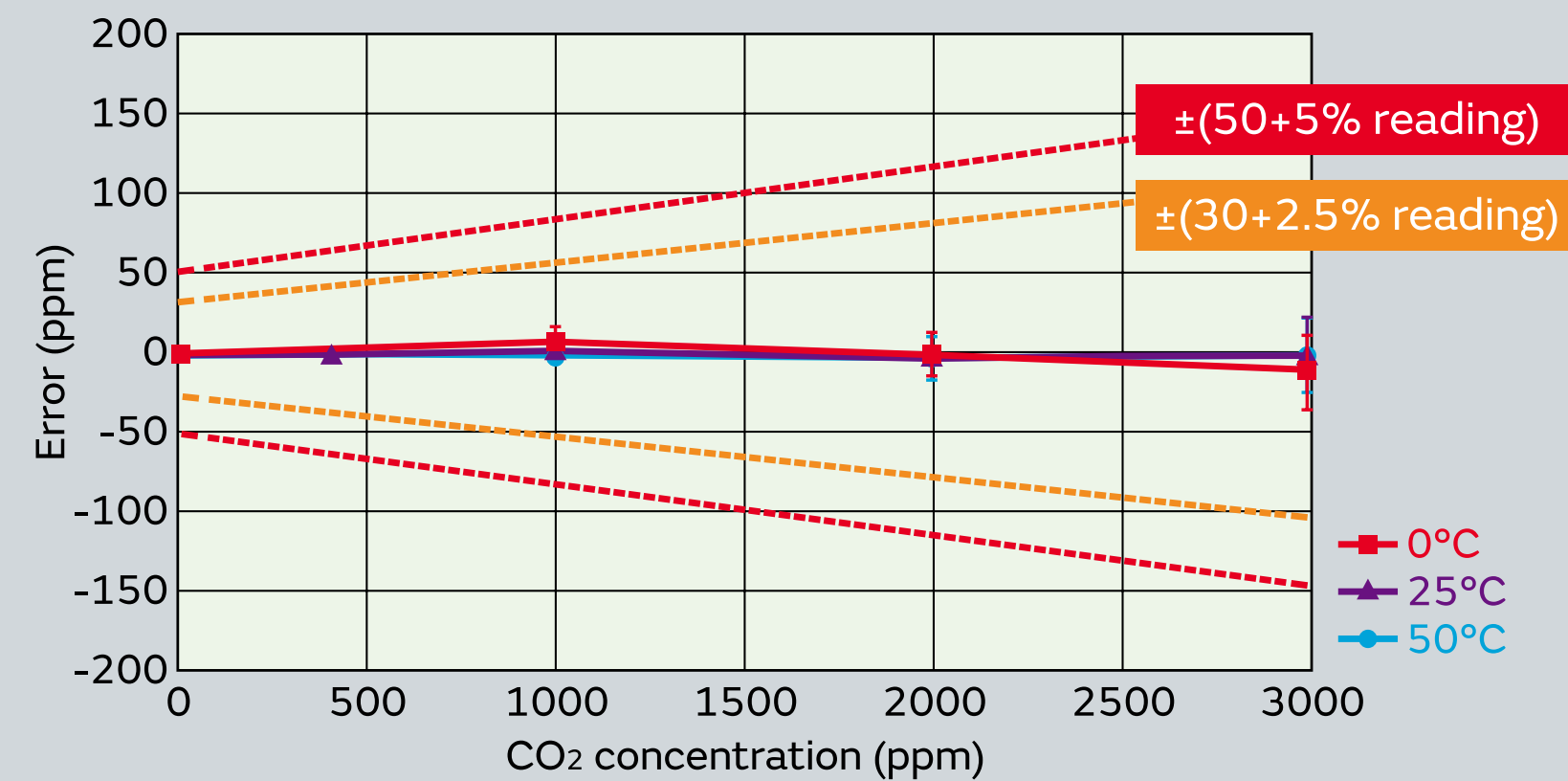



# MonoBK™ and UltraBK™

Line-up | **Small POL DC-DC converter**

Smart Agriculture

Power Solutions

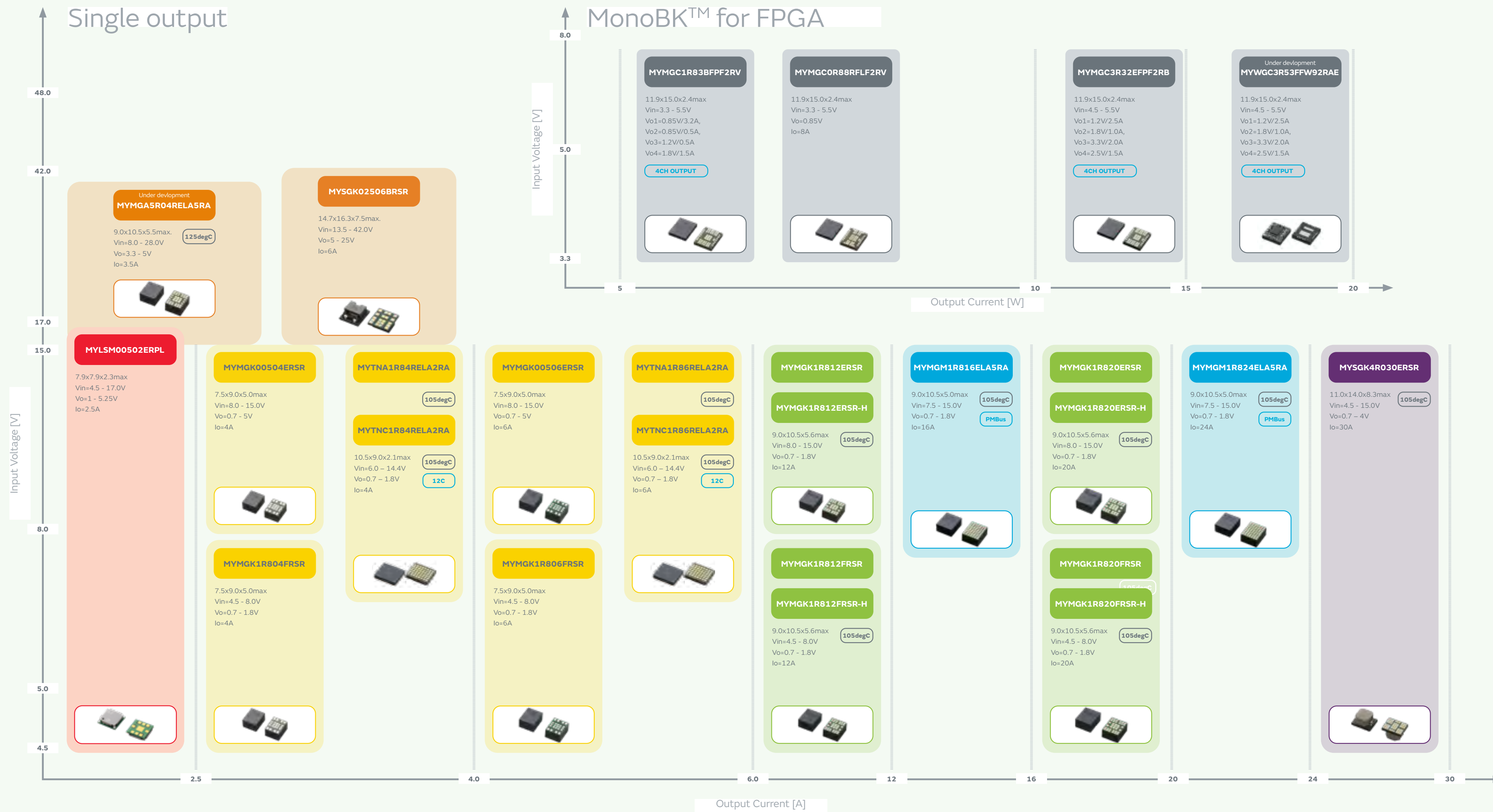



# Wi-Fi® Smart Module

Wireless communications

## Type 1LD

Murata is market leader in Wi-Fi® modules for embedded systems, providing superior quality, elevated performance modules for high volume production.

Murata's wireless modules will streamline your assembly operations, thus significantly reducing customer's design time. Additionally, we offer a variety of low-power products for sensor networks.

Type 1LD

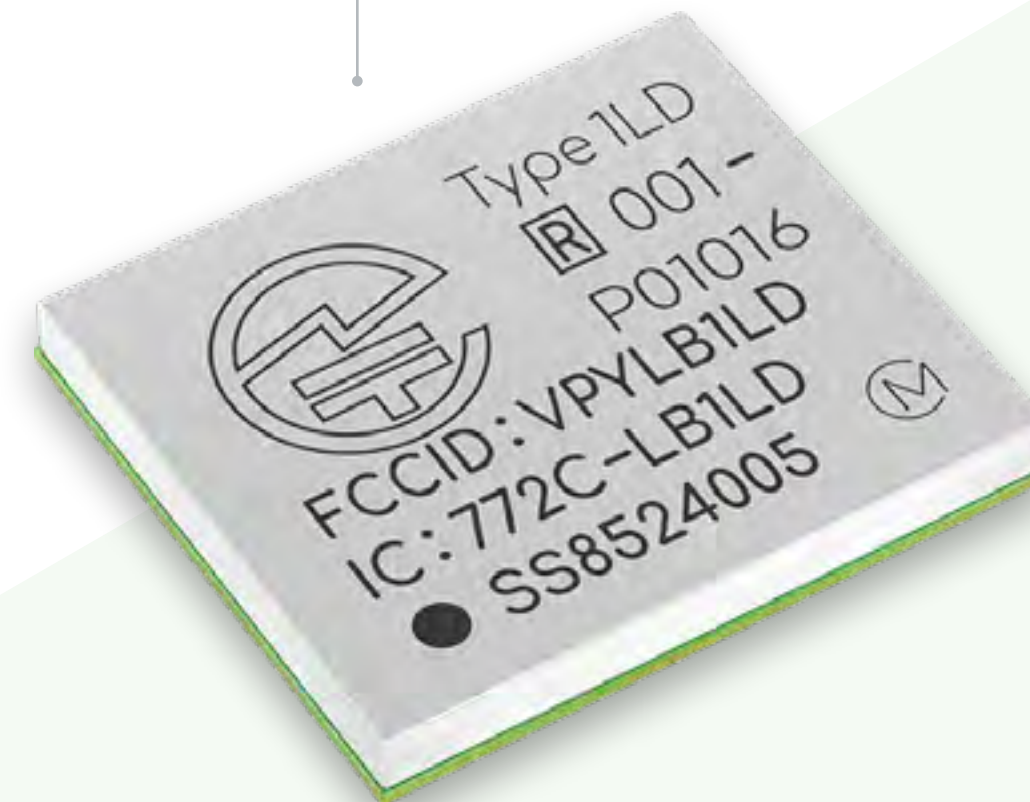

## Smart Agriculture Connectivity

### APPLICATIONS

- **Home and building automation**
  - Lighting control
  - Heating, Ventilation, Air-conditioning
- **Energy management system (EMS)**
- **Simple sensor network**
- **Home security**
- **Healthcare & fitness**

### PRODUCT SPECIFICATIONS

- **Chipset:**
  - Infineon (CYW43438)
  - + STM32 (ARM Cortex-M4F)
- **Size:** 8.9 x 7.8 x 1.2 mm
- **Peripheral Interface:** GPIO/SPI/UART/I2C/ADC/PWM
- **Operating Temperature:** -40°C to 85°C
- **Package:** Shielded Resin
  - Feature rich software hosted on module
  - 802.11 b/g/n 65Mbps, Wi-fi® Stack runs inside, 1MB Flash, 256KB RAM
  - Infineon WICED, SPP on Bluetooth® and GATT on Bluetooth® LE are supported by WICED Qualified for AWS IoT Core devices

### BLOCK DIAGRAM

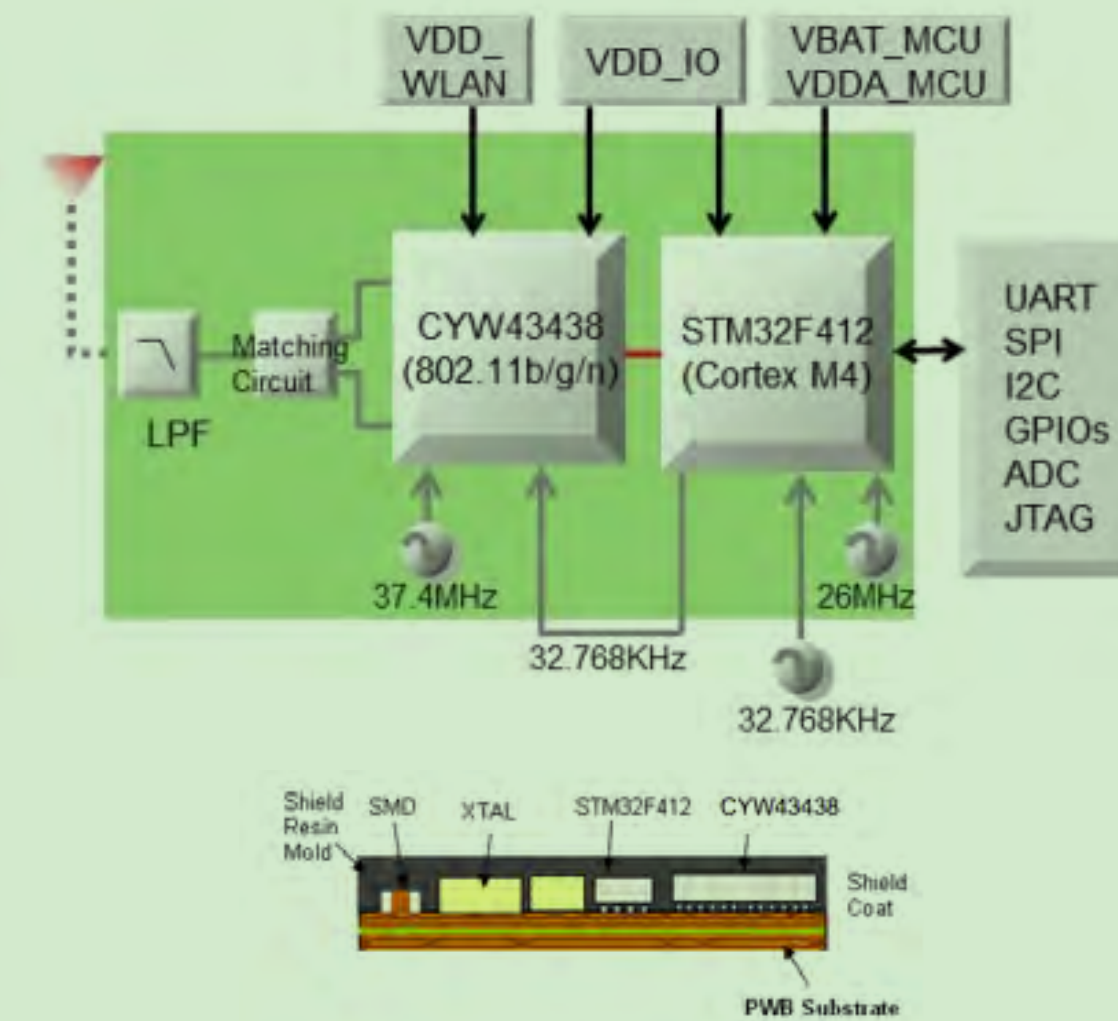

### FEATURES

- **Highly integrated**
- **FCC/IC/CE/TELEC compliant**
- **Shielded Ultra Small Wi-Fi® 11b/g/n + Bluetooth® 5.2 + MCU Module**





# Bluetooth® Low Energy Module

Wireless communications

## Type MBN52832

BLE is an ultra-low power communication technology that enables several years of operation off a button battery. Widespread adoption is being seen in fields like health management, fitness and home networks. BLE has also been adopted as a communication method by the Continua Health Alliance, a non-profit organization of healthcare and technology companies.

Type MBN52832

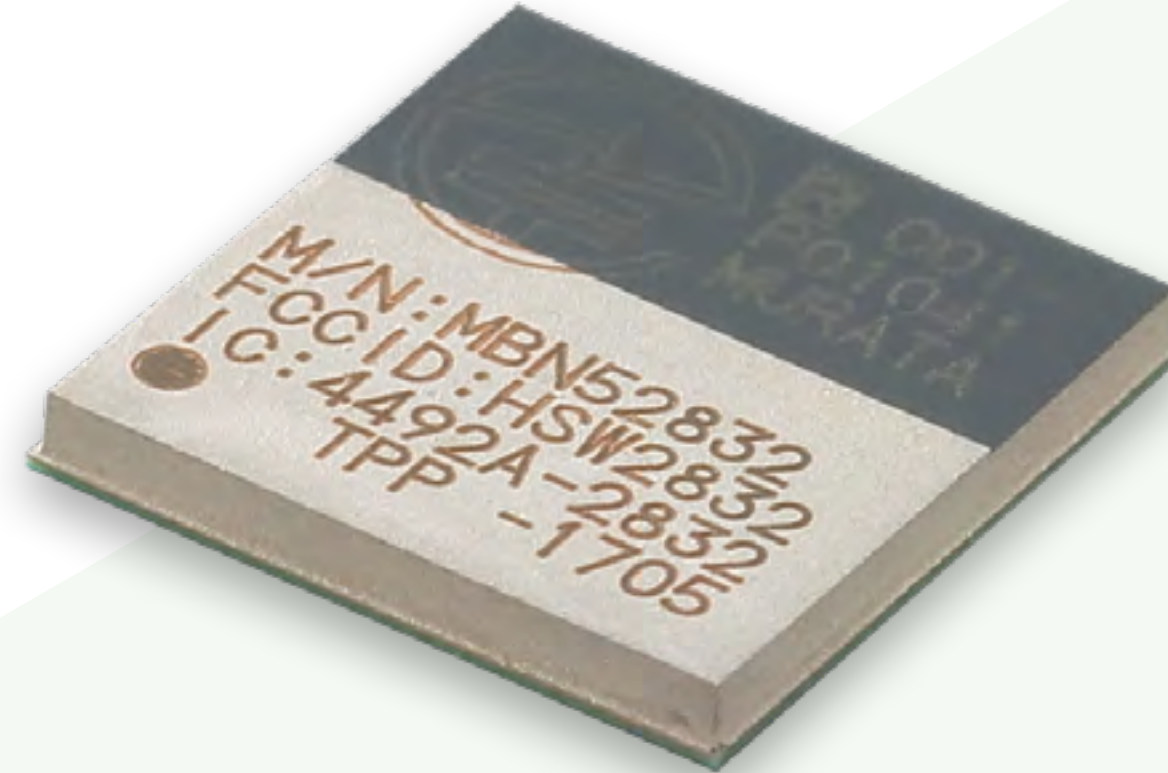

## Smart Agriculture Connectivity

### APPLICATIONS

- Proximity services
- Building automation
- Medical/healthcare
- Bluetooth beacons

### FEATURES

- **Powerful MCU core with large RAM and flash for user application**
  - ARM Cortex M4; 64K RAM; 512K flash
- **Low power consumption**
  - Tx 7mA @ 3.5dBm (DCDC mode)
  - Rx 6mA (DCDC mode)
- **Rich peripheral interface-20 GPIO ports**
- **Very small size: 7.4x7.0x0.9mm (max.)**
- **Fully certified**
  - FCC (US), IC (Canada), ETSI (EU), TELEC (Japan)
  - BT SIG Certificate
- **Support both on-board and external antenna version**
  - On-board PCB pattern antenna
  - External patch antenna
  - External dipole antenna
- **Bluetooth® 5.0**

### PRODUCT SPECIFICATIONS

- **Chipset:** nRF52832 Bluetooth® LE IC
- **Dimension:** 7.4x7.0x0.9mm
- **Package:** LGA
- **Antenna:** on-board or external
- **Max output power:** +4dBm (LDO mode)
- **Interfaces:** UART, SPI, 20 GPIO, 5ADC, SWD, PWM, I2C
- **Operating voltage:** 1.7V to 3.6V
- **Operating temperature range:** -40 to 85°C
- **OTA firmware upgrade**
- **RoHS compliant**
- **Regulatory certificate:** FCC/IC/ETSI/TELEC
- **Bluetooth® SIG qualification**

### BLOCK DIAGRAM

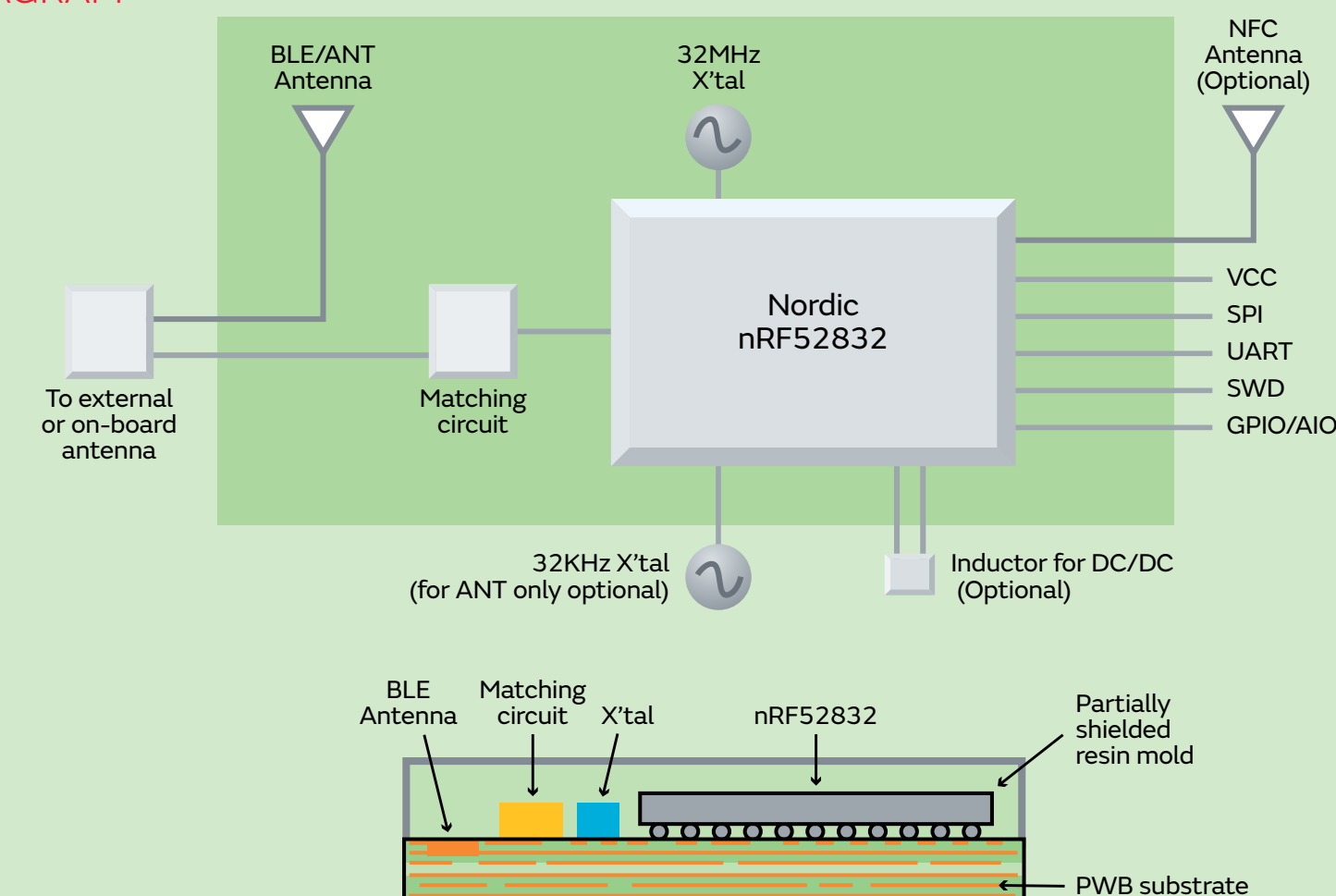



# UWB Modules

Wireless communications

Ultra-wideband (UWB) technology provides a highly effective means for providing secure and precise distance measurement. This is based on determining the time-of-flight (ToF) of radio waves. Murata offers an extensive portfolio of UWB modules.

## FEATURES

- Ultra-small dimensions
- High quality
- Lower power consumption

## APPLICATIONS

- Indoor navigation
- Smart retail/point-of-sales
- Smart building
- Smart locks
- Tags/tracking
- Contactless presence detection

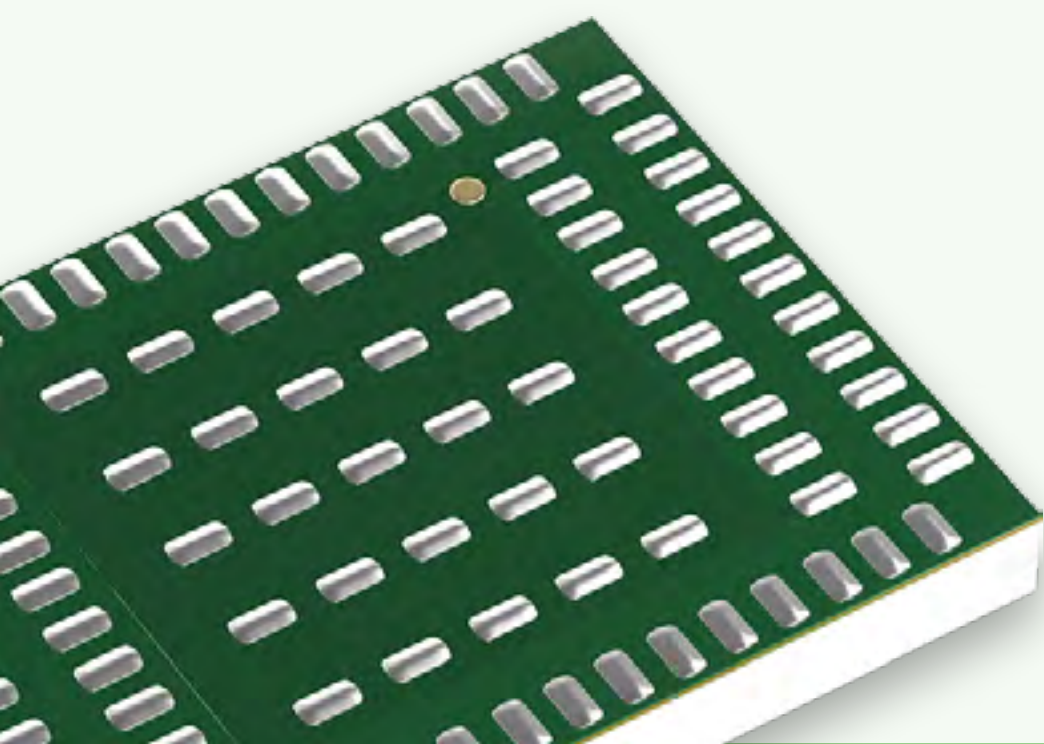

### TYPE 2BP

- Ultra small UWB module which includes NXP's SR150 UWB chipset, clock, filters and peripheral components.
- 3 Antenna support (3D AoA or 2D AoA support)
- **UWB Chip set:** NXP Trimension SR150
- **Antenna:** External

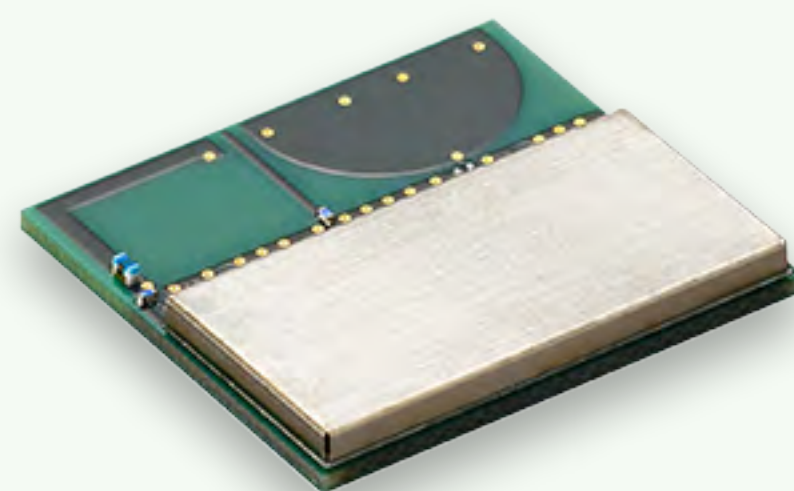

### TYPE 2DK

- All-in-one UWB + Bluetooth LE combo module which integrates NXP Trimension™ SR040 UWB Chipset, NXP QN9090 Bluetooth LE + MCU chipset, On board antenna and peripheral components.
- Ideally suited for UWB Tag/Tracker which operates by coin-cell battery, and general IoT devices.
- **UWB Chip set:** NXP Trimension™ SR040
- **Antenna:** Integrated



### TYPE 2AB

- UWB Chip set : Qorvo DW3110/3120
- FCC/IC/TELEC Reference Certified (Planned)
- Hostless module Integrated Nordic IC / nRF52840 which also have Bluetooth Low Energy function for waking up UWB and updating FW.
- Integrated 3-Axis sensor for saving battery
- Reference clock for UWB and MCU are embedded
- **UWB Chip set:** Qorvo DW3110/3120
- **Antenna:** External

## Smart Agriculture Connectivity



Contact us



Follow us



Subscribe

**muRata**

INNOVATOR IN ELECTRONICS





# LPWA Modules

## Wireless communications

Low power wide area (LPWA) networks provide a power efficient wireless communication technology for interconnecting devices together over a long range. LPWA is most suitable for applications such as IoT and machine-to-machine (M2M) communication, as well as various other situations where lower cost and lower power consumption are required. To respond to customers' needs, Murata has formed strategic partnerships with market leaders, and is accelerating the development of products using this highly appealing emerging technology.

### Type 1SC

The Type 1SC (LBAD00XX1SC) module is the world's smallest **Cat. M1/NB-IoT module** with global certification. It supports GPS/GNSS, OpenMCU, Integrated SIM.

Murata has partnered with Truphone, making MVNO network communications possible through the use of eSIM.

### FEATURES

- **Small size**  
Size attractive to wearables that previously had no means of cellular connectivity
- **Standardized**  
Through PTCRB/GCF certification improved global interoperability with global wireless networks operators for IoT applications
- **Low power**  
Protocol designed specifically for low current consumption extending battery lifetime up to 10+ years

Type 1SC  
LBAD00XX1SC

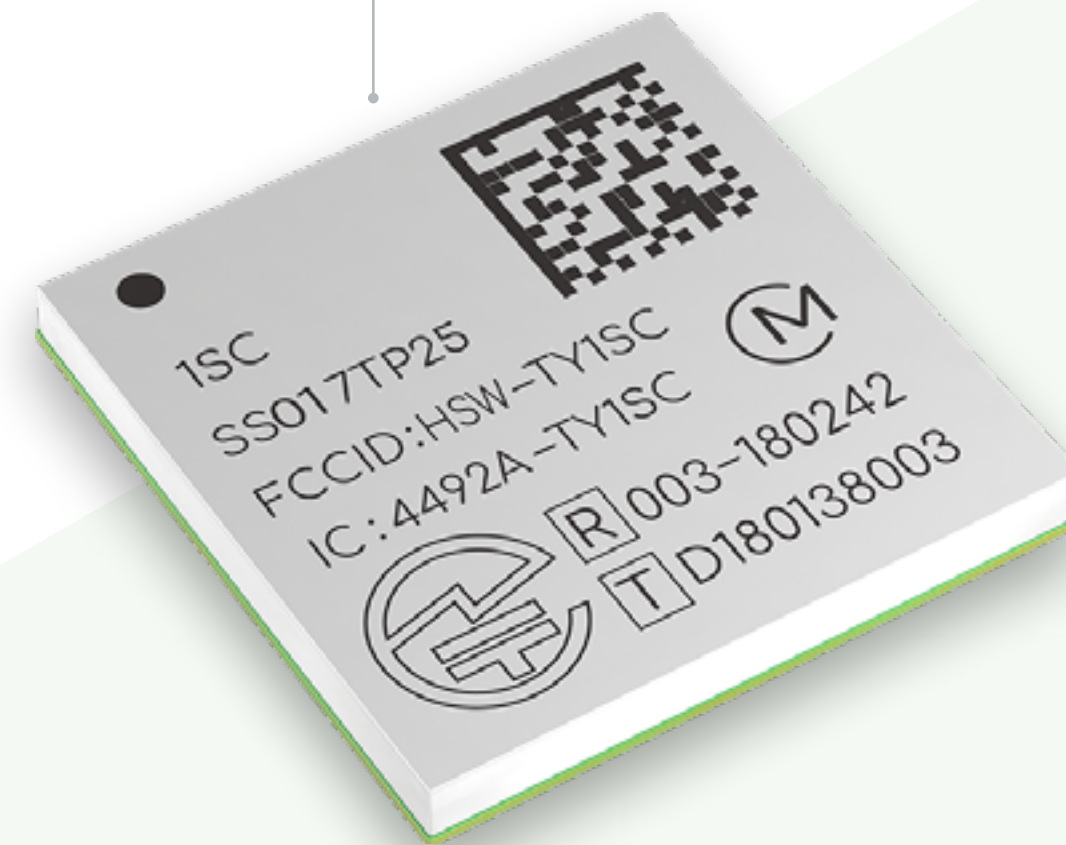

### PRODUCT SPECIFICATIONS

- **Support LTE Band:**  
Low Bands 5,8,12,13,14 (CAT M1 Only), 17,18,19,20,26,28 - Mid Bands 1,2,3,4,25
- **Chipset:** Altair ALT1250
- **Modulation:** LTE Cat.M1/NB-IoT Release 13 (\*Release 14 – SW Upgrade)
- **Antenna:** External
- **Type Package:** Resin Mold
- **Dimension:** 11.1 x 11.4 x 1.5 mm (max)
- **Transmit Power:** +23dBm max
- **Sleep Mode Current:**  
eDRX Current Consumption (avg)/LTE-M: 43 uA  
PSM Current Consumption (avg)/LTE-M: 1.4 uA
- **RoHS:** Yes
- **Software Features:** AT commands, IPv4/IPv6 stack with TCP and UDP protocol, SSL/TLS, MQTT, OpenMCU(Optional), GPS/GLONASS(Optional), iUICC(Optional)
- **Certified:**  
FCC/IC/RED/TELEC/KC/NCC GCF/PTCRB
- **Certified Carrier:**  
AT&T, KT, SKT, Pelion, Deutsch Telekom, Vodafone, Softbank, KDDI, Docomo, Soracom, Truphone

## Smart Agriculture Connectivity

### APPLICATIONS

- Smart metering
- Smart parking
- Home security/home automation
- Vehicle fleet management
- Wearables/trackers
- Industrial M2M communication
- IoT edge nodes

### BLOCK DIAGRAM

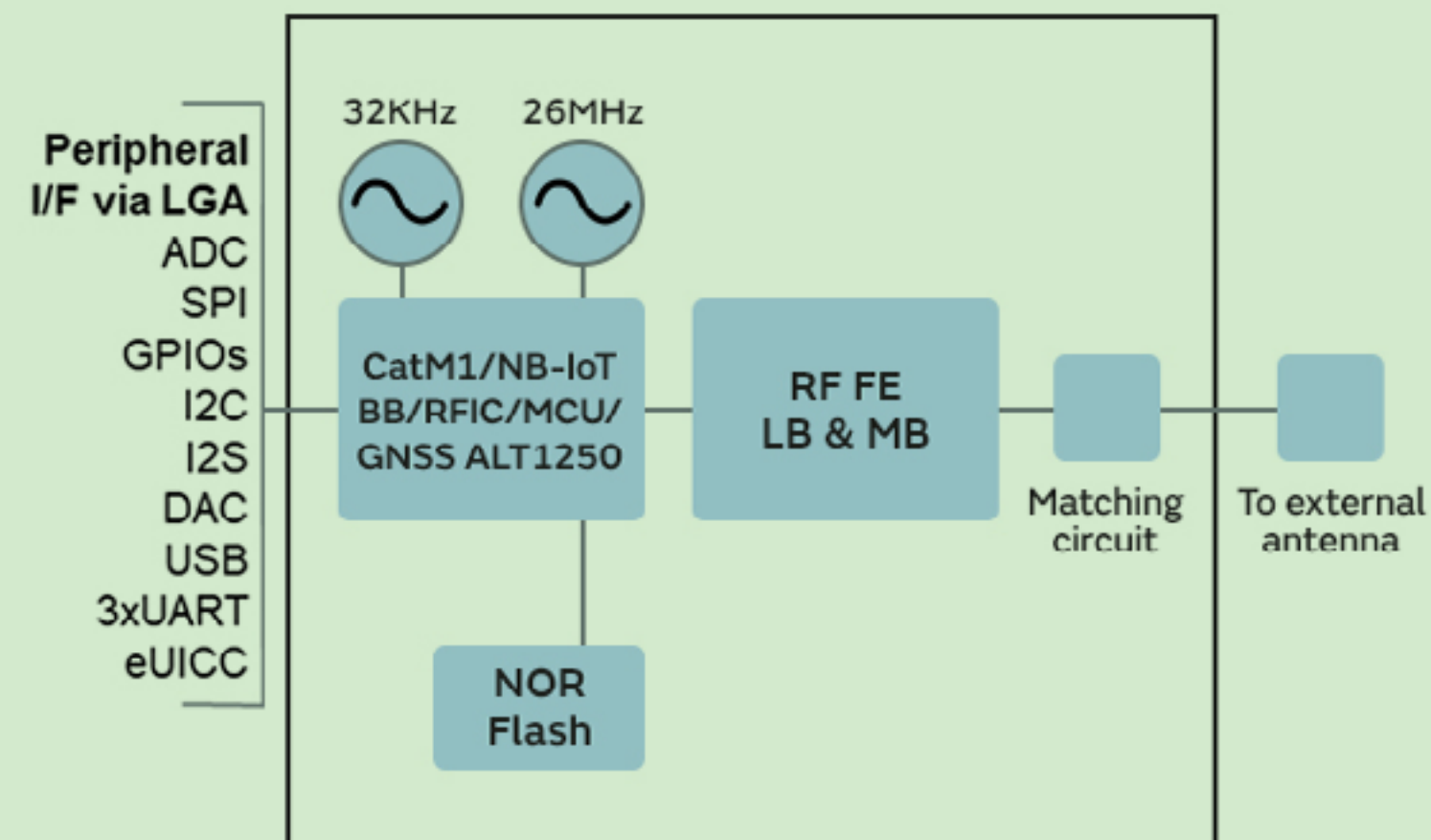



# LPWA Modules

Wireless communications

## Type 1SJ

The Type 1SJ (LBAA0QB1SJ) module is one of the smallest **LoRaWAN™** modules in the industry.

This module has a lower power consumption and higher output than previous products. Radio Law certification has already been obtained for major regions.

Open MCU design support is available.

Type 1SJ  
LBAA0QB1SJ

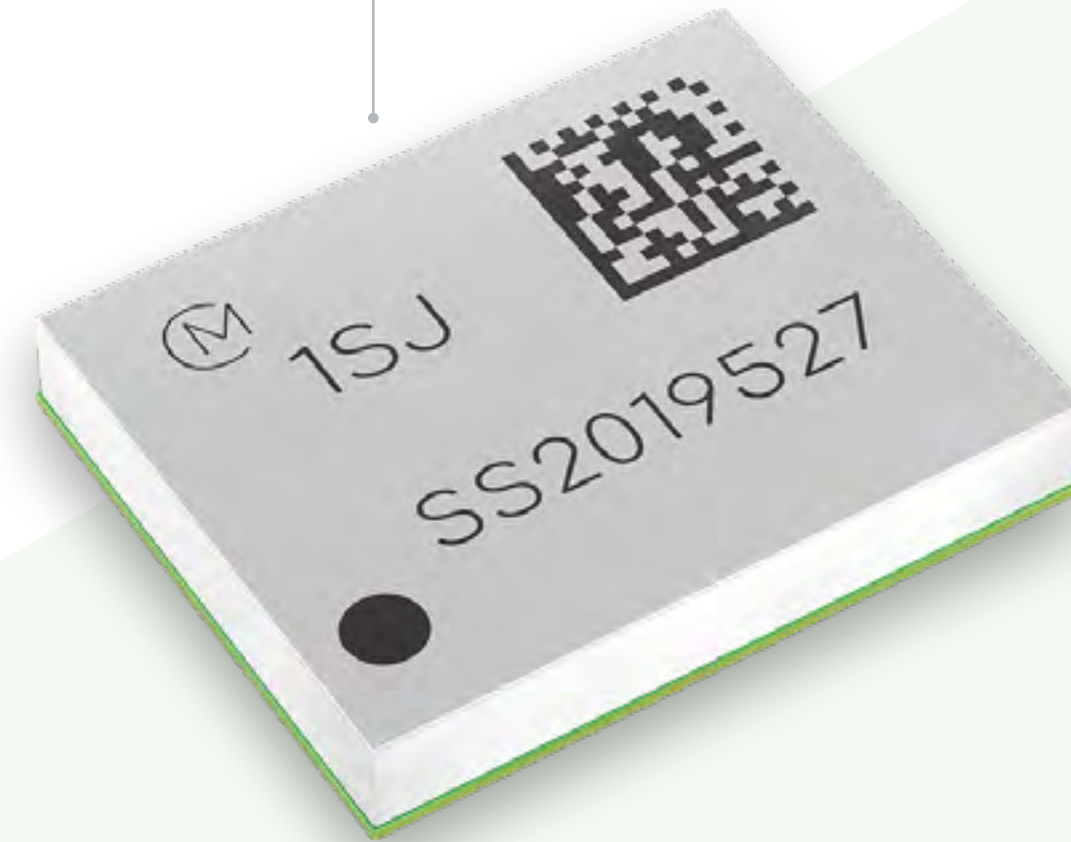

## Smart Agriculture Connectivity

### APPLICATIONS

- Smart metering
- Smart lighting
- Smart parking
- Smart agriculture
- Industrial M2M
- IoT edge nodes

### PRODUCT SPECIFICATIONS

- **RF/BB chipset:** SX1262
- **MCU chipset:** STM32L0 series  
CPU: Cortex M0+  
RAM: 20KB  
Flash: 192KB
- **Peripheral interfaces:** UART/SPI/I2C/GPIOs/ADC
- **Radio certification:** FCC, IC, CE
- **Module size:** 10.0x8.0x1.60mm
- **Package:** Shielded Resin Mold
- **Frequencies:** EU / US / India / Pacific
- **Operating temp:** -40 to +85 °C
- **Supply voltage:** 2.2V to 3.6V
- **RF transmit power:** +14dBm / +21.5dBm
- **RF sensitivity:** -135dBm
- **Frequency band:** 860MHz-930MHz

### FEATURES

- **Compact and low cost**
- **Battery life**  
10 years
- **Low Range**  
10km
- **Pre-certified radio regulatory approvals**  
868 & 915 MHz spectrum

### BLOCK DIAGRAM

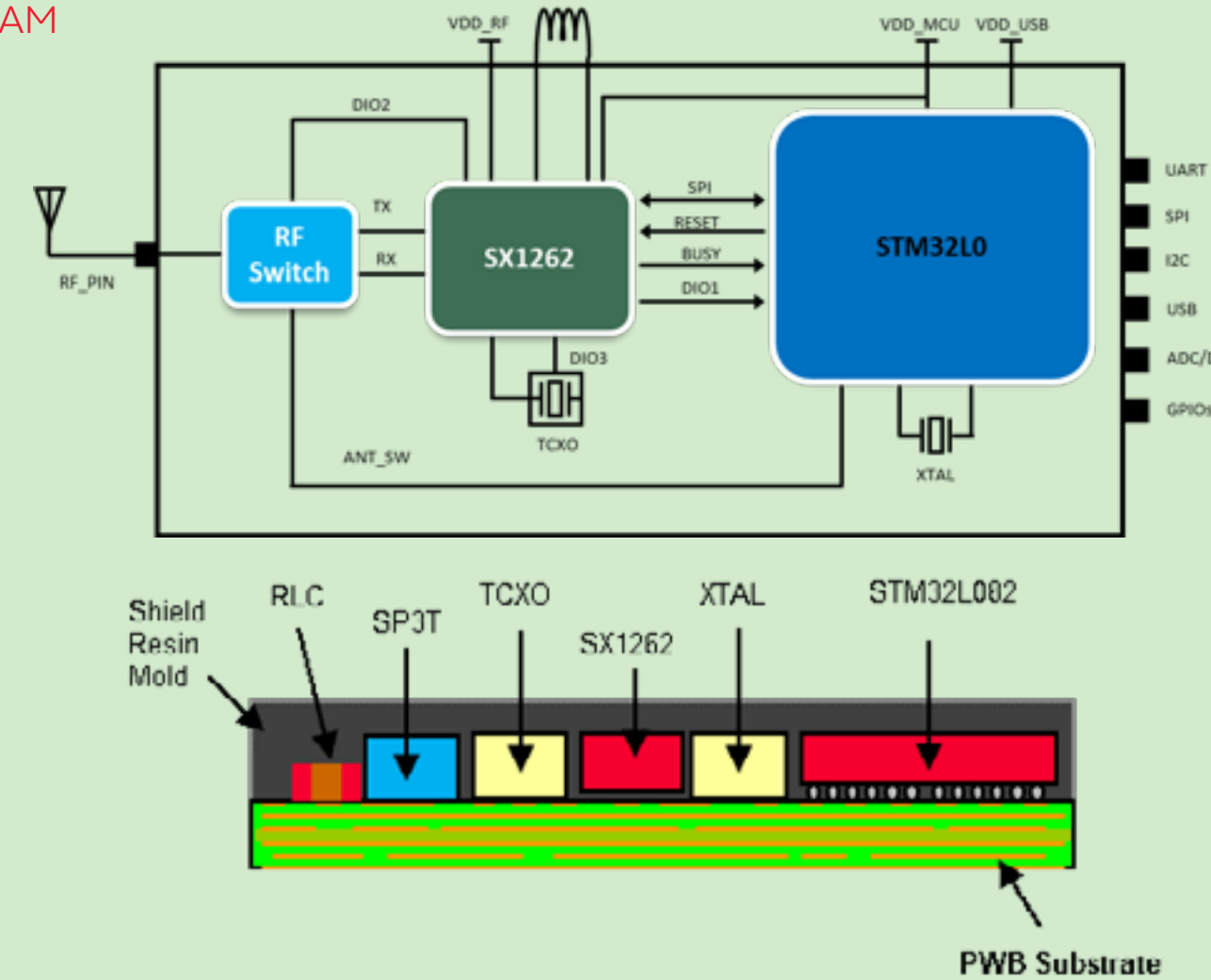



# Modular Solutions

Wireless communications

## M.2 boards

Our M.2 modules, co-developed by Embedded Artists, are designed for evaluation, integration and ease-of-use. These professionally designed and proven M.2 modules provide easy evaluation of different Wi-Fi®/Bluetooth® solutions, lower your risk and shorten your time to market.

- FEATURES**
- **Standard M.2 form factor**
  - **Reference-certified antennas & snap-off option**
  - **UFL connectors for antenna or conducted testing**
  - **Comprehensive interface support including SDIO, PCIe, UART, PCM, and radio control lines**

## µSD adapter

Murata's µSD-M2 adapter board offers an out-of-the-box experience for NXP i.MX with Murata's M.2 module family. All WLAN/BT- necessary signals are included on M.2 connector pins (Key 'E') including:

- **WLAN SDIO**
- **WLAN PCIe**
- **BT H4 UART**
- **BT PCM/I2S**
- **GPIOs**



**Type 1XA**  
Dual band  
Wi-Fi® 11a/b/g/n/ac  
2x2 MIMO / RSDB  
+ Bluetooth® 5.2 (PCIe)



**Type 1XZ**  
Dual band  
Wi-Fi® 11a/b/g/n/ac  
2x2 MIMO / RSDB  
+ Bluetooth® 5.2 (SDIO)



**Type 1YM**  
Dual band  
Wi-Fi® 11a/b/g/n/ac  
2x2 MIMO  
+ Bluetooth® 5.2

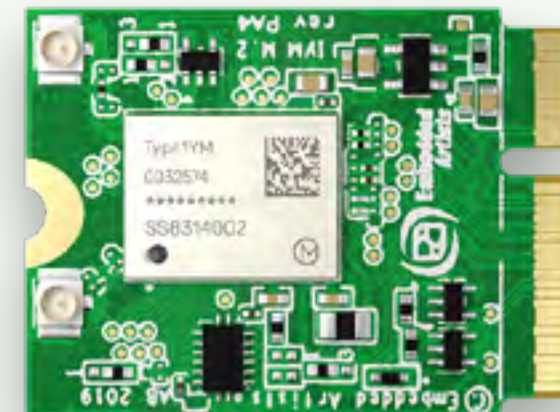

**Type 1DX**  
Wi-Fi® 11b/g/n  
+ Bluetooth® 5.1



**Type 1MW**  
Dual band  
Wi-Fi® 11a/b/g/n/ac  
+ Bluetooth® 5.0

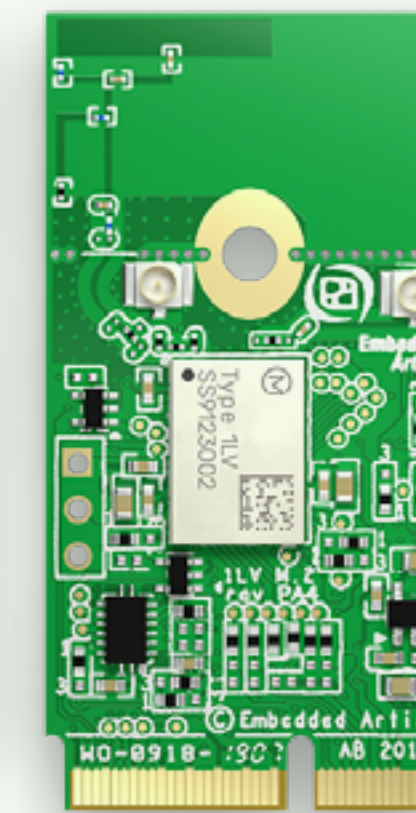

**Type 1LV**  
Dual band  
Wi-Fi® 11a/b/g/n/ac  
+ Bluetooth® 5.0



**Type 1ZM**  
Dual band  
Wi-Fi® 11a/b/g/n/ac  
+ Bluetooth® 5.1





# Fully Modular Systems

## Wireless communications

Murata and Embedded Artists have developed a full modular system which offers IoT designers a quick, easy and cost-effective route to world-class connectivity.

Development kits are available for use as your evaluation/prototyping platform. The kits include the hardware and software components needed to get up-and-running with your software development on day 1.

- Easily evaluate different Wi-Fi/BT solutions – by just switching M.2 modules
- Fast-to-market integration
- Less regulatory burden
- Use certified antennas
- Re-use FCC certification

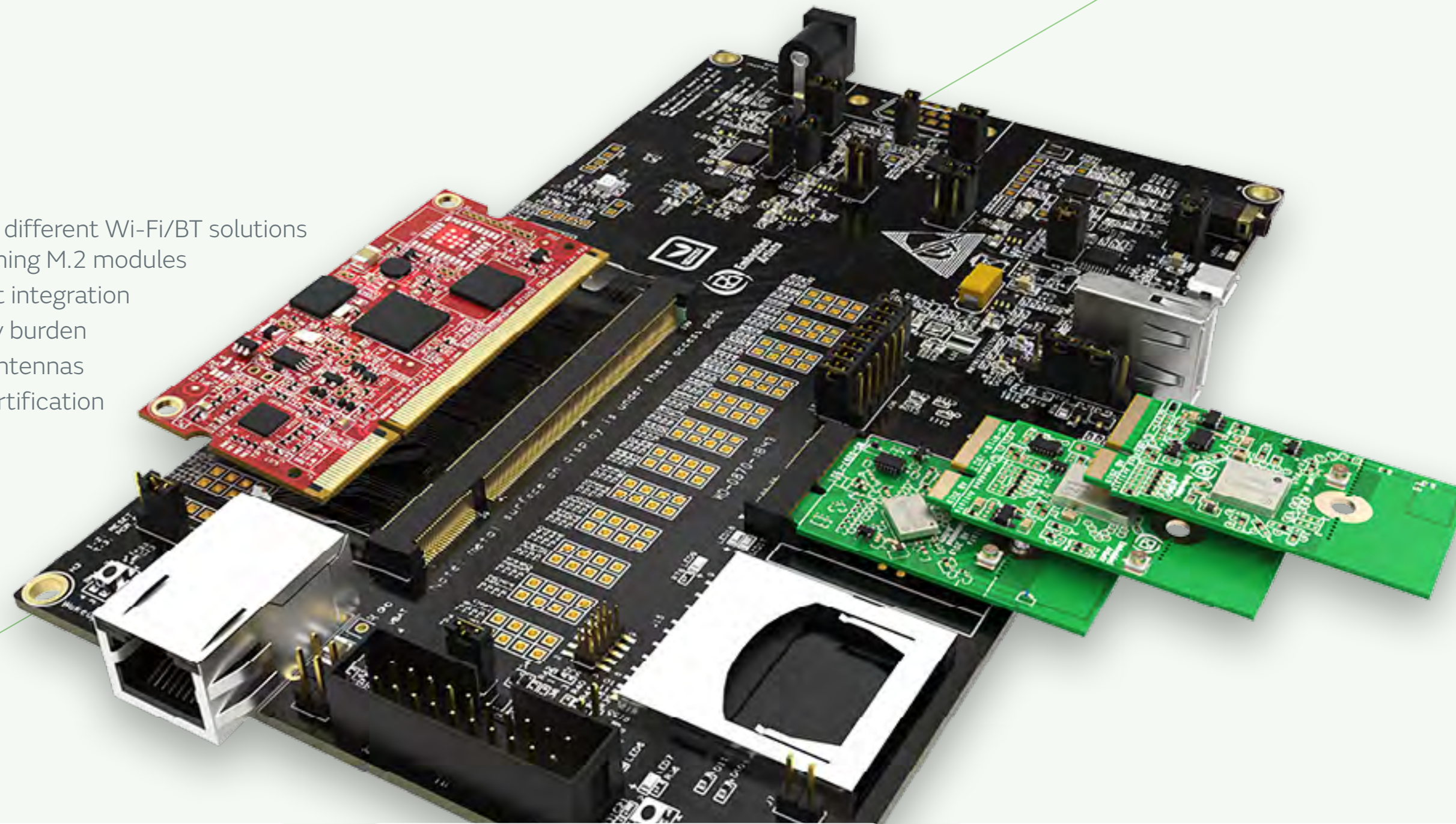

### 1. CHOOSE A COM/OEM BOARD

Embedded Artists have developed a suite of COM computer-on-module (COM) units and OEM boards, integrating all core components around a variety of NXP processors and microcontrollers:

- i.MX RT1062
- i.MX RT1052
- i.MX 8M Quad
- i.MX 8M Mini uCOM
- i.MX 8M Nano uCOM
- i.MX 6Quad
- i.MX 6DualLite
- i.MX 6Ultralite
- i.MX 6SoloX
- i.MX 7Dual
- i.MX 7Dual uCOM
- i.MX 7ULP uCOM



### 2. PLUG INTO COM CARRIER BOARD

There are two types of carrier boards: One for i.MXRT family boards (with a slot for the COM or OEM board) and one which is suitable for the MPU COM boards and offers...

- Support for i.MX8 designs
- Support for M.2 Key E interface (typically Wi-Fi@/BT), including advanced debug features developed in cooperation with Murata and Cypress
- Support for M.2 Key B interface (typically Cellular/SSD)
- Support for USB 3.0

### 3. PLUG IN YOUR CONNECTIVITY

Choose the Murata/Embedded Artists M.2 connectivity module appropriate for your application in terms of:

- Performance
- Power consumption
- Range
- Cost
- Temperature range
- Supported standards

### 4. START YOUR EVALUATION

- Pre-loaded software drivers
- Comprehensive user manuals
- Responsive support



Contact us



Follow us



Subscribe



# A Wide Range of Wireless Communication Modules

Murata offers an extensive portfolio of wireless modules based on Cypress and NXP chipsets.

Modules with integrated MCUs are used in combination with Cypress WICED software. Wi-Fi® and Bluetooth® capabilities are also incorporated and the MCU can be used to run an application.

Other modules are radio-only and they can be used in combination with a MPU (Linux®) or MCU (RTOS).

These modules cover a wide array of different specifications - from single band Wi-Fi® 2.4GHz to dual band Wi-Fi® 11ac 2.4GHz and 5GHz with MIMO. Most of the options also include Bluetooth®.

With this variety of wireless modules Murata can cover a diverse breadth of applications - going all the way from small connected gadgets or sensor nodes to high data rate video streaming devices.



## Modules with MCU

### Type 1LD

#### Shielded ultra-small Wi-Fi 11b/g/n+Bluetooth 5.2 + MCU

- Cypress CYW43438 chipset
- STM32 (ARM Cortex-M4F) MCU



### Type 1GC

#### Shielded ultra-small dual band Wi-Fi 11a/b/g/n + Ethernet + MCU

- Cypress CYW43907 chipset
- Processor: ARM Cortex-R4



## Radio-only modules

### Type 1FX

#### Shielded ultra-small Wi-Fi 11b/g/n

- Cypress CYW43364 chipset



### Type 1DX

#### Shielded ultra-small Wi-Fi 11b/g/n + Bluetooth 5.1

- Cypress CYW4343W chipset



### Type 1LV

#### Shielded ultra-small dual band Wi-Fi 11a/b/g/n/ac + Bluetooth 5.0

- Cypress CYW43012 chipset



### Type 1MW

#### Shielded ultra-small dual band Wi-Fi 11a/b/g/n/ac + Bluetooth 5.0

- Cypress CYW43455 chipset



# Soldered-down in major development platforms

Wireless communications

Many of Murata's extensive range of wireless modules are designed into leading development platforms. These include Linux®, FreeRTOS, etc.



Arduino Portenta H7

- **NXP i.MX**
  - i.MX 8M Mini EVK - Type 1MW
  - i.MX 8M Nano EVK - Type 1MW
  - i.MX 7ULP EVK - Type 1DX
  - i.MX RT Alexa Voice Board - Type 1DX
- **Cypress WICED**
  - PSoC® 6 WiFi-BT Pioneer Board & Prototyping Kit - Type 1DX/Type 1LV
  - CYW43907 Eval Kit - Type 1GC
- **ST Micro - Linux®**
  - STM32MPI Discovery Kit - Type 1DX
- **Micropython**
  - Arduino Portenta H7 - Type 1DX



i.MX 8M Nano EVK



## Module with MCU

### Type ABR

#### 802.11 b/g/n WiFi

- NXP 88MW320 chipset
- ARM Cortex-M4 200MHz

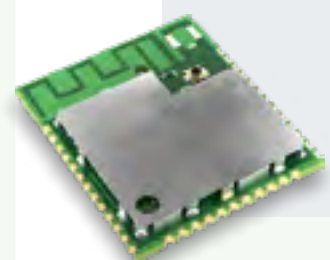

## Radio-only modules

### Type 1ZM

#### Wi-Fi 11 a/b/g/n/ac Bluetooth 5.1

- NXP 88W8987 chipset



Contact us



Follow us



Subscribe



# CR Batteries

## Micro Batteries

Murata offers a wide range of primary micro batteries with high performance and reliability, taking advantage of 40+ years technology development and manufacturing expertise.

### FEATURES

- **40+ years technology development and manufacturing expertise.**
- **Acquisition of ISO 9001/14001 certification.**
- **Full automated assembling lines with high productivity.**



## Smart Agriculture Batteries

### Coin Manganese Dioxide Lithium Batteries

- High voltage, high energy density
- Wide range; including heat-resistant models
- ISO/TS16949 certified



### Lightweight, High Voltage and High Energy Density

The battery voltage is 3V, almost double that of normal alkaline or manganese batteries.



### Excellent discharge characteristics

Voltage characteristics remain stable even for a long period of discharge.



### Excellent long-term reliability

Murata's innovative sealing technology minimize battery self-discharge.

Battery	Type	Nominal Voltage	Capacity	Operating Temp.	Features
Coin Manganese Dioxide Lithium (CR)	Standard	3.0V	30-1000mAh	-30 to 70°C	Lineup of 10 models from small size and thin models to high capacity models
	Extended Temp.	3.0V	220-2000mAh	-40 to 85°C	Good balance between wide operating temperature and affordability
	Heat resistant	3.0V	210-1000mAh	-40 to 125°C	Wide operating temperature
	High Drain	3.0V	200-500mAh	-30 to +70°C	High peak 50mA pulse (x2 times) vs. Standard





# Global Locations

For details please visit [www.murata.com](http://www.murata.com)

## ⚠ Note

### 1 Export Control

#### For customers outside Japan:

No Murata products should be used or sold, through any channels, for use in the design, development, production, utilization, maintenance or operation of, or otherwise contribution to (1) any weapons (Weapons of Mass Destruction [nuclear, chemical or biological weapons or missiles] or conventional weapons) or (2) goods or systems specially designed or intended for military end-use or utilization by military end-users.

#### For customers in Japan:

For products which are controlled items subject to the “Foreign Exchange and Foreign Trade Law” of Japan, the export license specified by the law is required for export.

2 Please contact our sales representatives or product engineers before using the products in this catalog for the applications listed below, which require especially high reliability for the prevention of defects which might directly damage a third party's life, body or property, or when one of our products is intended for use in applications other than those specified in this catalog.

- ① Aircraft equipment
- ② Aerospace equipment
- ③ Undersea equipment
- ④ Power plant equipment
- ⑤ Medical equipment
- ⑥ Transportation equipment (vehicles, trains, ships, etc.)
- ⑦ Traffic signal equipment
- ⑧ Disaster prevention / crime prevention equipment
- ⑨ Data-processing equipment
- ⑩ Application of similar complexity and/or reliability requirements to the applications listed above

3 Product specifications in this catalog are as of March 2020. They are subject to change or our products in it may be discontinued without advance notice. Please check with our sales representatives or product engineers before ordering. If there are any questions, please contact our sales representatives or product engineers.

4 Please read rating and ⚠CAUTION (for storage, operating, rating, soldering, mounting and handling) in this catalog to prevent smoking and/or burning, etc.

5 This catalog has only typical specifications. Therefore, please approve our product specifications or transact the approval sheet for product specifications before ordering.

6 Please note that unless otherwise specified, we shall assume no responsibility whatsoever for any conflict or dispute that may occur in connection with the effect of our and/or a third party's intellectual property rights and other related rights in consideration of your use of our products and/or information described or contained in our catalogs. In this connection, no representation shall be made to the effect that any third parties are authorized to use the rights mentioned above under licenses without our consent.

7 No ozone depleting substances (ODS) under the Montreal Protocol are used in our manufacturing process.

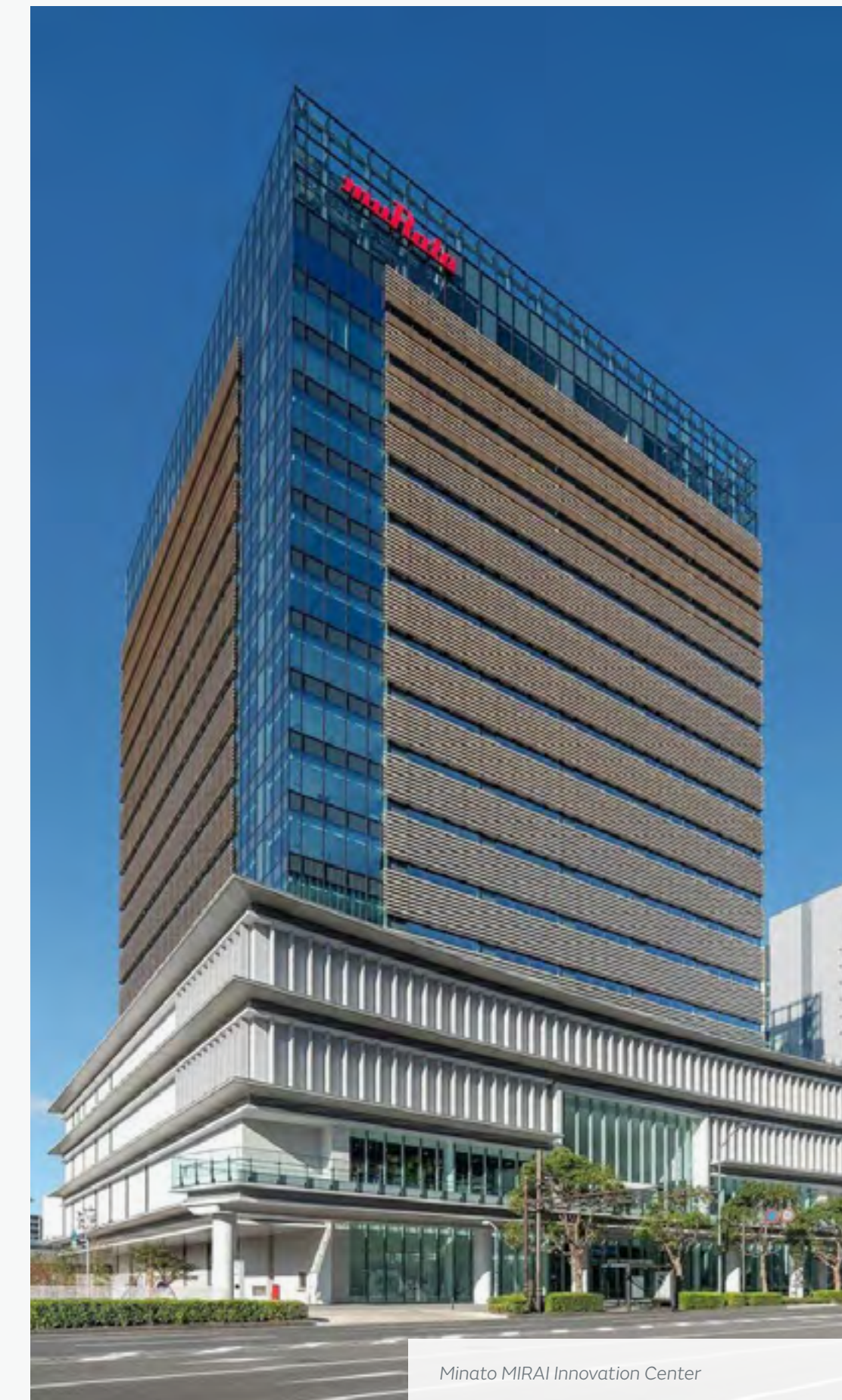

Minato MIRAI Innovation Center



Contact us



Follow us



Subscribe

**muRata**  
INNOVATOR IN ELECTRONICS