

BergStik® 2.54mm Unshrouded Headers

BergStik® 2.54mm pitch unshrouded headers provide Board-to-Board, Wire-to-Board and Cable-to-Board interconnect solutions for all types of electronic equipment and devices.

www.fci.com/products/bergstik

CONTENT PAGE

BERGSTIK® 2.54MM UNSHROUDED HEADERS

▶ Overview	3
▶ For Pin-in-Paste Processes	4-7
▶ Vertical Headers Standard sizes	8-9
▶ Vertical Headers Special sizes	10-11
▶ Continuous Headers	12-13
▶ Right Angle Headers Standard sizes	14-15
▶ Right Angle Headers Special sizes	16-17
▶ Stacking Headers	18-19

BERGSTIK® 2.54MM UNSHROUDED HEADERS

OVERVIEW

BergStik® 2.54mm unshrouded headers are available in surface-mount (SMT), through-hole (THT), press-fit, stacking and pin-in-paste (PIP) versions. Designed in single and double row, they are available in straight or right angle options, from 2 to 72 positions.

Featuring a “breakaway” design, each connector can be cut or broken to length to suit the application profile. The maximum current rating is 3A per contact.

This product range is extended with BergStik® 2.54mm unshrouded vertical headers in 0.25µm plating, available in standard sizes. It offers an economical solution for various applications. It is also specified up to 100 mating cycles.

BergStik® product range provides Board-to-Board, Wire-to-Board and Cable-to-Board interconnect solutions for all electronic equipment and devices.

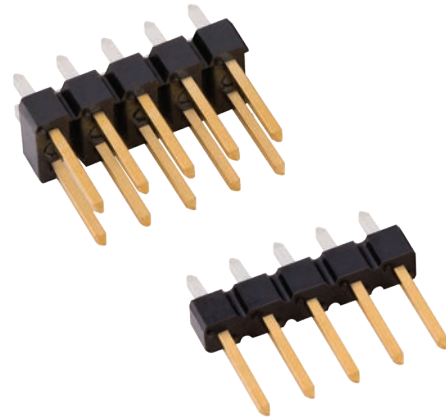

FEATURES

- High temperature thermoplastic material
- Variable spacing height for stacking headers
- Allow dual entry; mating from top or bottom
- Blank 0.64mm square contacts presents 4 surfaces of equal quality
- Standoff design
- Duplex plating
- Tin-lead plating in press-fit area
- Retention legs option
- Press-fit designed to fit 1.02mm diameter hole, solder-to-board product
- Meets DIN 41651 specification, HE13 and BT D2632

BENEFITS

- Reflow compatible
- Cater to a wide range of applications
- Suitable for mezzanine application and gives more flexibility in meeting different stack height requirements
- Can be used for wire wrapping
- Allows cleaning to remove soldering contamination
- Cost-efficient
- Easy pin insertion onto PCB
- High retention force onto PCB
- Same layout on THT and press-fit
- Qualified product

BERGSTIK® UNSHROUDED HEADERS FOR PIN-IN-PASTE PROCESSES

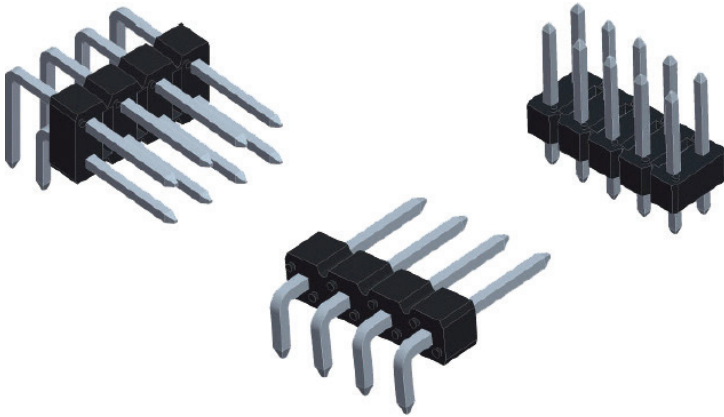

Pin-in-Paste (PIP) technology allows the use of THT products in SMT manufacturing processes. THT connectors are automatically or manually soldered to PCB, and soldered in the same operation as the SMT connectors. Mechanical strength is retained through THT leads. This process is critical for applications in industrial and automotive markets.

PRODUCT

PLASTIC MATERIAL

BergStik® PIP headers are moulded in high temperature thermoplastic. The headers are able to withstand exposure to 260°C peak temperature for 30 seconds maximum in a convection, infrared or vapor phase reflow oven.

HOUSING DESIGN

A special housing has been developed for the double row straight product. A row of higher standoffs has been placed in the longitudinal center axis, between both rows of pins for a good solder paste deposit around the pin. Please follow the stencil design guidelines TA-894 and TA-897 on the following page in order to avoid solder paste deposit under the standoffs.

APPLICATION

FCI's application guideline helps to achieve optimum performance for BergStik® PIP process.

STENCIL DESIGN

The stencil design is crucial for a good solder joint. It determines the amount of paste and the position of the paste print on the board. Each PCB hole has its own stencil aperture with enough spacing in between to allow separate solder deposits. This prevents solder robbing from one hole to another and ensures the correct amount of solder paste for each hole. The print position is placed asymmetrical to optimize the flow of molten solder paste.

PASTE APPLICATION

The amount of paste for each hole depends on the soldering process parameters and the degree of hole filling. It is recommended to apply the squeegee at a 45° angle. You can use a smaller angle for an even greater degree of hole filling. The squeegee moves in parallel with the shorter sides of the stencil apertures.

BOARD LAYOUT

Please use a hole of 1.00 +/- 0.05 mm for an optimum paste deposit. For automatic pick-and-place, lean towards the upper end of the tolerance. Refer to TA-894 for further information.

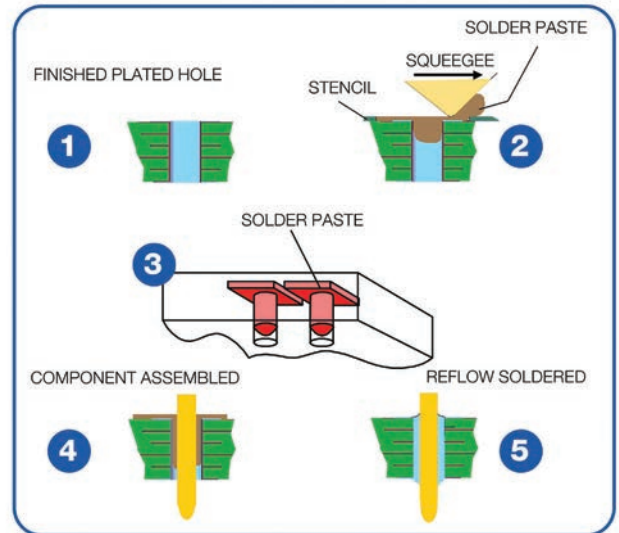

TA - 897

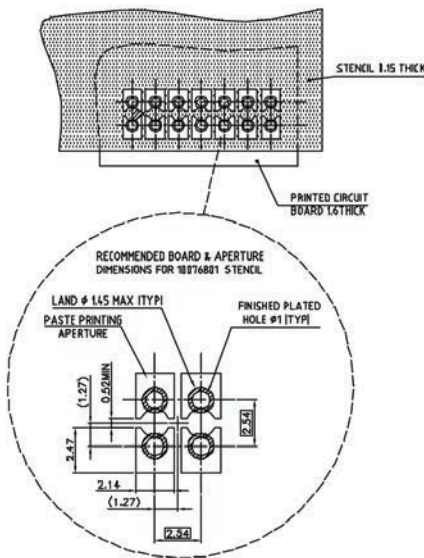

TA - 894

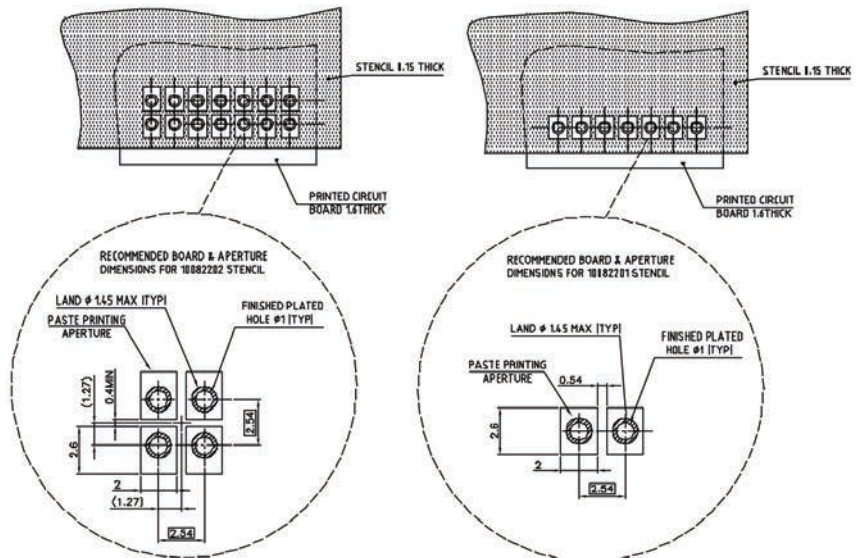

BERGSTIK® UNSHROUDED HEADERS FOR PIN-IN-PASTE PROCESSES



TECHNICAL INFORMATION

MATERIALS

- Housing: PCT
- Color: Black
- Flammability Rating: UL94V-0
- Pins: Copper Alloy
- Plating: Selective Gold or GXT or full Tin over 1.2µm Nickel

ELECTRICAL PERFORMANCE

- Current Rating: 3A per contact
- Insulation Resistance: 5000MΩ min.
- Dielectric Withstanding Voltage: 1500V



ENVIRONMENTAL

- Operating Temperature: -65°C to +130°C

MECHANICAL PERFORMANCE

- Retention Force: 8.8N min

SPECIFICATIONS

-  File no. E66906
-  File no. LR46923
- Product Drawing: 10076801/ 10082201/ 10082202
- Product Specification: BUS-12-019

APPROVALS AND CERTIFICATIONS

- RoHS compliant according to the European Union Directive 2002/95/IEC

PART NUMBER SELECTOR

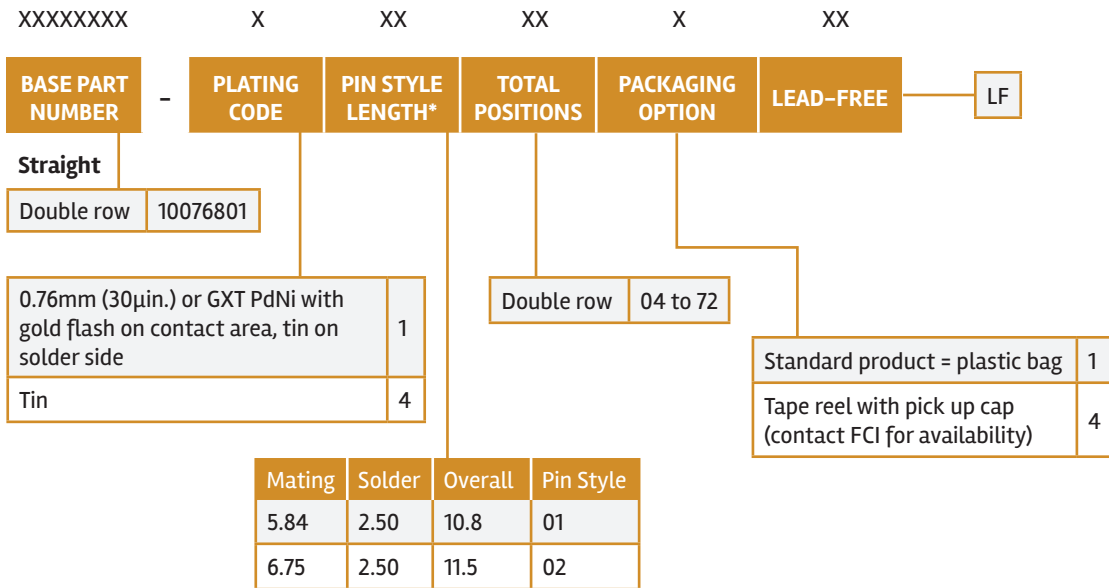

*Other pin style are available upon request

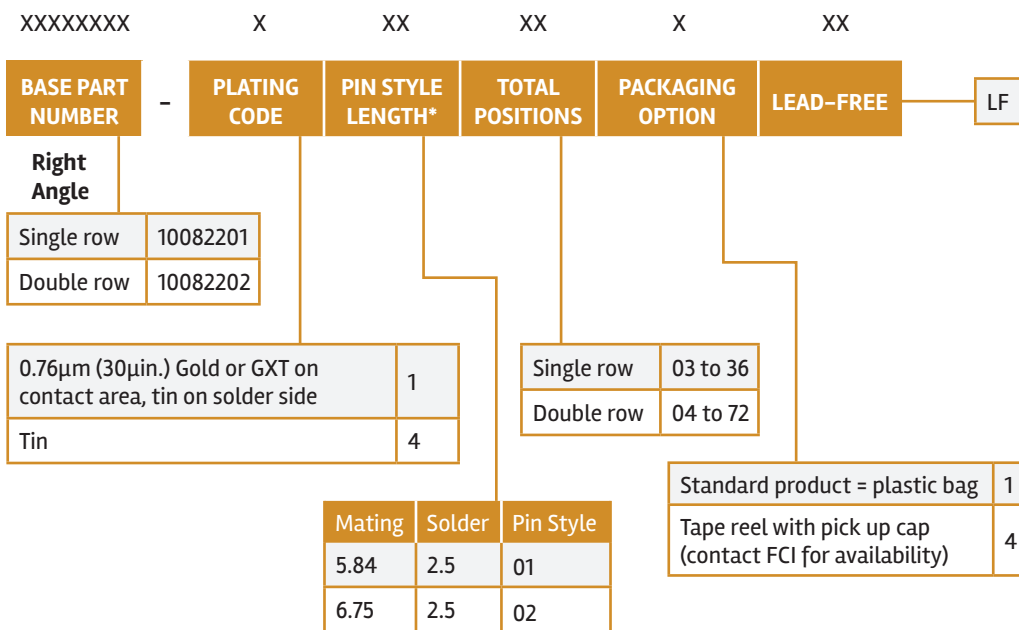

*Other pin style are available upon request

BERGSTIK® UNSHROUDED VERTICAL HEADERS STANDARD SIZES

APPLICATION

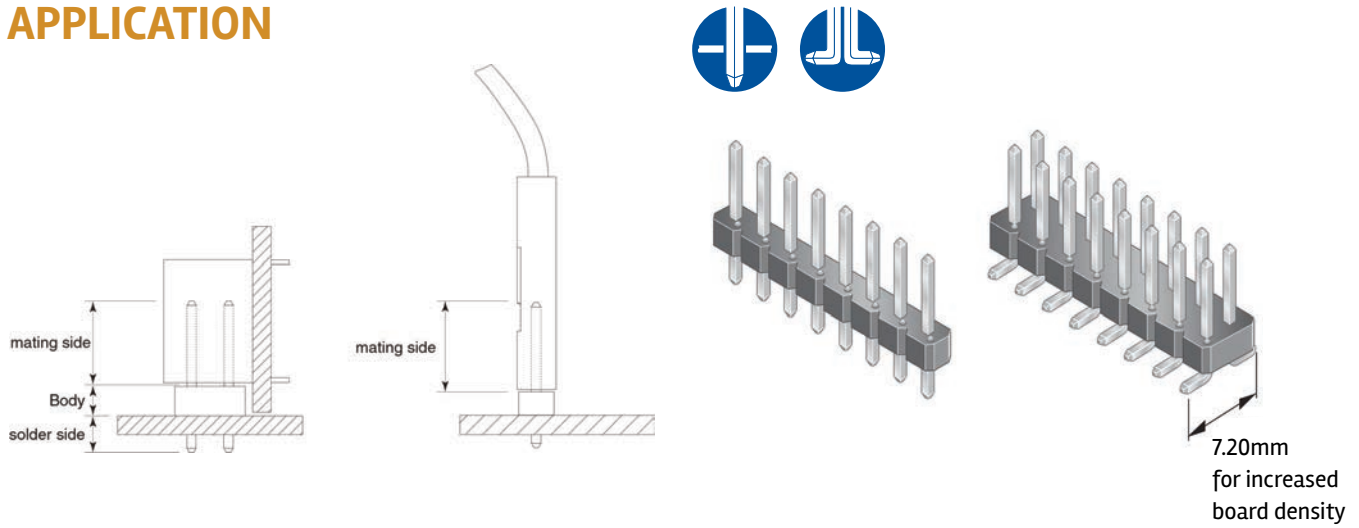

PRODUCT

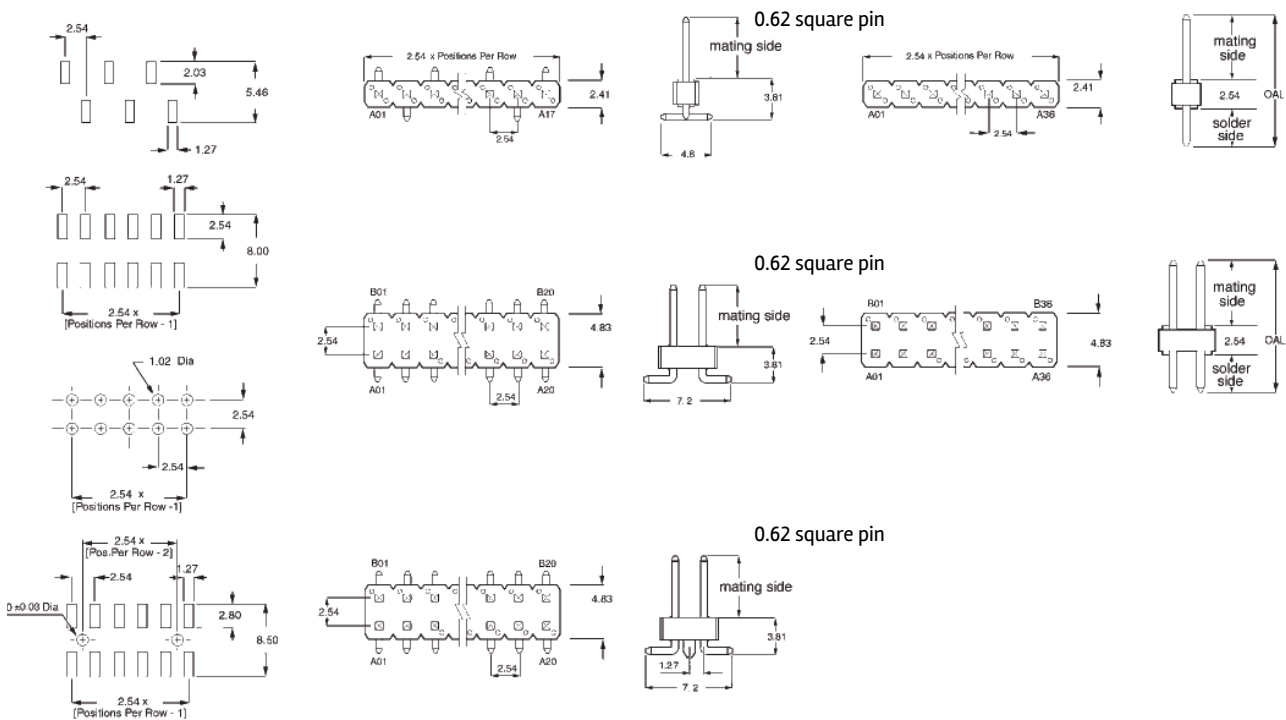

Recommended PCB Layouts

Dimensions in mm

TECHNICAL INFORMATION

MATERIALS

- Housing: High temperature thermoplastic, Black
- Flammability Rating: UL94V-0
- Pin: Phosphor-bronze
- Plating: Gold or Tin over 1.27µm (50µin.) Nickel

ELECTRICAL PERFORMANCE

- Current Rating: 3A per contact
- Insulation Resistance: 5000MΩ min.
- Dielectric Withstanding Voltage: 1500V

ENVIRONMENTAL

- Operating Temperature: -65°C to +125°C

MECHANICAL PERFORMANCE

- Retention Force: 9N min.

SPECIFICATIONS

- File no. E66906
- File no. LR46923
- Product Drawing: 77311/ 77313/ 98401/ 95278
- Product Specification: BUS-12-114
- Tape and Reel Packaging Data: TA-840

APPROVALS AND CERTIFICATIONS

- RoHS compatible according to the European Union Directive 2002/95/IEC

PACKAGING

- Bags
- Optional: Tubes or tape-and-reel with pick-up cap (only applicable for SMT pin style 01)

PROCESSING INFORMATION

- Compatible with wave, vapor-phase, and (for SMT) IR reflow soldering processes
- Recommended IR profile TA 842 for SMT

PART NUMBER SELECTOR

XXXXX X XX X XX XX

BASE PART NUMBER	PLATING CODE	PIN STYLE LENGTH	PACKAGING OPTION	TOTAL POSITIONS	LEAD-FREE																																
<table border="1"> <thead> <tr> <th colspan="2">THT</th> </tr> </thead> <tbody> <tr> <td>Single row</td> <td>77311</td> </tr> <tr> <td>Double row</td> <td>77313</td> </tr> <tr> <th colspan="2">SMT</th> </tr> <tr> <td>Single row</td> <td>98401</td> </tr> <tr> <td>Double row</td> <td>95278</td> </tr> </tbody> </table>						THT		Single row	77311	Double row	77313	SMT		Single row	98401	Double row	95278																				
THT																																					
Single row	77311																																				
Double row	77313																																				
SMT																																					
Single row	98401																																				
Double row	95278																																				
<table border="1"> <thead> <tr> <th>Configuration</th> <th>Option</th> </tr> </thead> <tbody> <tr> <td>Plastic bag</td> <td>THT</td> </tr> <tr> <td>Tape-and-reel with pick-up cap</td> <td>SMT</td> </tr> <tr> <td>Tube with pick-up cap</td> <td>SMT</td> </tr> </tbody> </table>						Configuration	Option	Plastic bag	THT	Tape-and-reel with pick-up cap	SMT	Tube with pick-up cap	SMT																								
Configuration	Option																																				
Plastic bag	THT																																				
Tape-and-reel with pick-up cap	SMT																																				
Tube with pick-up cap	SMT																																				
<table border="1"> <thead> <tr> <th colspan="4">THT</th> </tr> <tr> <th>Mating Length</th> <th>Solder</th> <th>Overall</th> <th>Pin Style</th> </tr> </thead> <tbody> <tr> <td>5.84</td> <td>2.41</td> <td>10.80</td> <td>01*</td> </tr> <tr> <td>5.84</td> <td>3.05</td> <td>11.43</td> <td>18*</td> </tr> <tr> <td>5.84</td> <td>3.42</td> <td>11.80</td> <td>02</td> </tr> <tr> <td>6.60</td> <td>2.66</td> <td>11.82</td> <td>27</td> </tr> <tr> <td>7.75</td> <td>3.06</td> <td>13.35</td> <td>22</td> </tr> <tr> <td>6.75</td> <td>2.90</td> <td>12.20</td> <td>24*</td> </tr> </tbody> </table>						THT				Mating Length	Solder	Overall	Pin Style	5.84	2.41	10.80	01*	5.84	3.05	11.43	18*	5.84	3.42	11.80	02	6.60	2.66	11.82	27	7.75	3.06	13.35	22	6.75	2.90	12.20	24*
THT																																					
Mating Length	Solder	Overall	Pin Style																																		
5.84	2.41	10.80	01*																																		
5.84	3.05	11.43	18*																																		
5.84	3.42	11.80	02																																		
6.60	2.66	11.82	27																																		
7.75	3.06	13.35	22																																		
6.75	2.90	12.20	24*																																		
<table border="1"> <thead> <tr> <th colspan="2">SMT</th> </tr> <tr> <th>Mating</th> <th>Pin Style</th> </tr> </thead> <tbody> <tr> <td>5.84</td> <td>01</td> </tr> <tr> <td>8.08</td> <td>02</td> </tr> </tbody> </table>						SMT		Mating	Pin Style	5.84	01	8.08	02																								
SMT																																					
Mating	Pin Style																																				
5.84	01																																				
8.08	02																																				
<table border="1"> <tbody> <tr> <td>0.76µm (30µin.) Gold or GXT on contact, tin on solder side</td> <td>1</td> </tr> <tr> <td>0.38µm (15µin.) Gold or GXT on contact area, tin on solder side</td> <td>8</td> </tr> <tr> <td>0.25µm (10µin.) Gold or GXT on contact area, tin on solder side NEW</td> <td>5</td> </tr> <tr> <td>Tin</td> <td>4</td> </tr> </tbody> </table>						0.76µm (30µin.) Gold or GXT on contact, tin on solder side	1	0.38µm (15µin.) Gold or GXT on contact area, tin on solder side	8	0.25µm (10µin.) Gold or GXT on contact area, tin on solder side NEW	5	Tin	4																								
0.76µm (30µin.) Gold or GXT on contact, tin on solder side	1																																				
0.38µm (15µin.) Gold or GXT on contact area, tin on solder side	8																																				
0.25µm (10µin.) Gold or GXT on contact area, tin on solder side NEW	5																																				
Tin	4																																				
<table border="1"> <tbody> <tr> <td>Single row THT</td> <td>02 to 36</td> </tr> <tr> <td>Single row SMT</td> <td>03 to 17</td> </tr> <tr> <td>Double row THT</td> <td>04 to 72</td> </tr> <tr> <td>Double row SMT</td> <td>04 to 50</td> </tr> <tr> <td>Double row SMT with pegs</td> <td>08 to 50</td> </tr> </tbody> </table>						Single row THT	02 to 36	Single row SMT	03 to 17	Double row THT	04 to 72	Double row SMT	04 to 50	Double row SMT with pegs	08 to 50																						
Single row THT	02 to 36																																				
Single row SMT	03 to 17																																				
Double row THT	04 to 72																																				
Double row SMT	04 to 50																																				
Double row SMT with pegs	08 to 50																																				

*Most popular configurations

BERGSTIK® UNSHROUDED VERTICAL HEADERS SPECIAL SIZES

APPLICATION

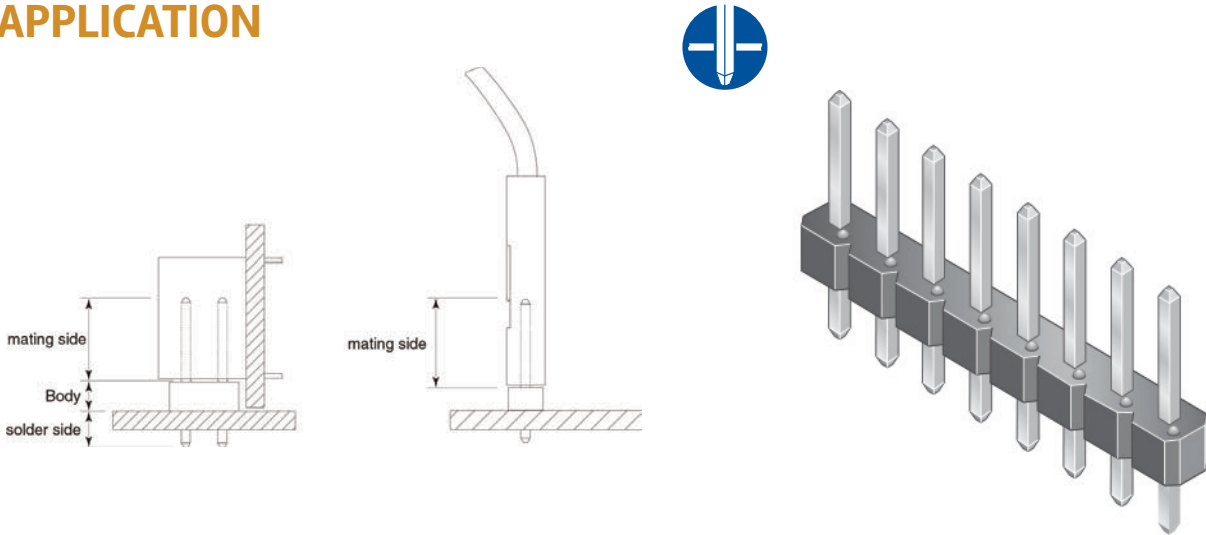

PRODUCT

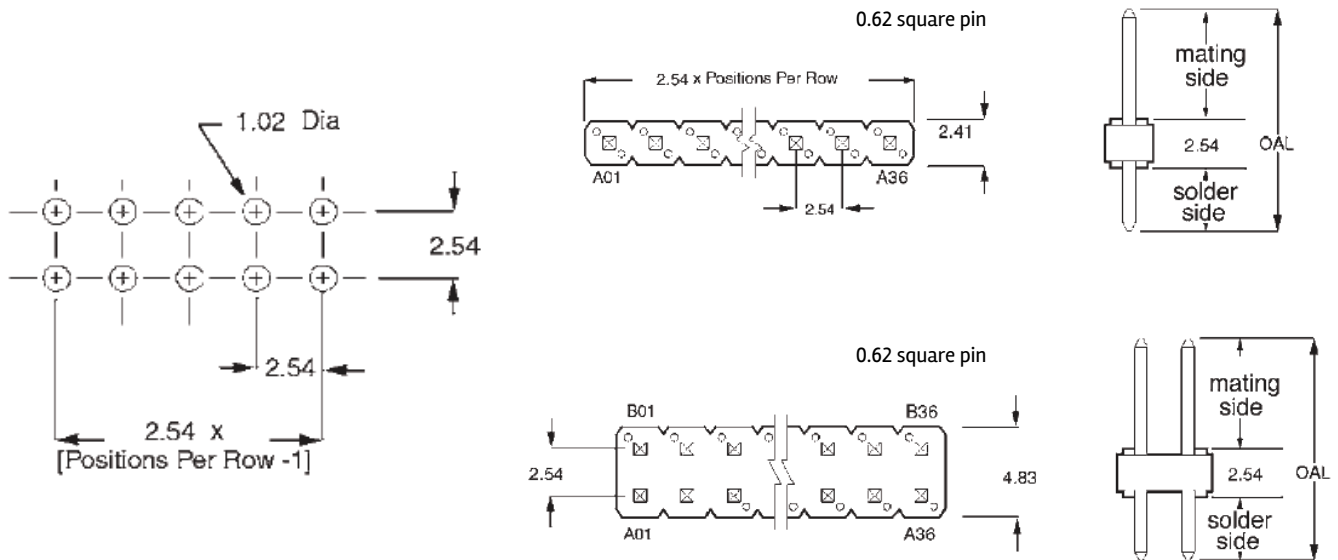

Recommended PCB Layouts

Dimensions in mm

TECHNICAL INFORMATION

MATERIALS

- Housing: High temperature thermoplastic, Black
- Flammability Rating: UL94V-0
- Pin: Phosphor-bronze
- Plating: Gold or Tin over 1.27µm (50µin.) Nickel

ELECTRICAL PERFORMANCE

- Current Rating: 3A per contact
- Insulation Resistance: 5000MΩ min
- Dielectric Withstanding Voltage: 1500V

ENVIRONMENTAL PERFORMANCE

- Operating Temperature: -65°C to +125°C

MECHANICAL PERFORMANCE

- Retention Force: 9N min.
- Retentive Leg Insertion Force: >44.48N max.
- Retentive Leg Board Retention: 2.22N

SPECIFICATIONS

- File no. E66906
- File no. LR46923
- Product Drawing: 68000/ 67996
- Product Specification: BUS-12-114

APPROVALS AND CERTIFICATIONS

- RoHS compatible according to the European Union Directive 2002/95/IEC

PACKAGING

- Bags
- Optional: Tubes or tape-and-reel with pick-up cap (only applicable for SMT pin style 01)

PROCESSING INFORMATION

- Compatible with wave, vapor-phase, and IR reflow soldering processes

PART NUMBER SELECTOR

Customize your own part number using custom dimensions (Please allow for initial setup on our system)

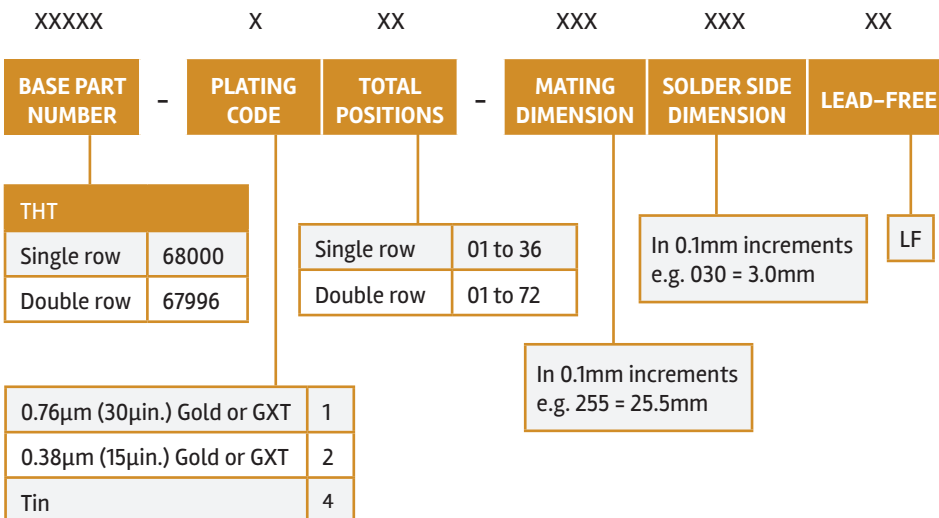

Note: 1. The total combined dimension for mating and solder side may not exceed 27mm
 2. Standard packaging in bulk
 3. Special packaging availability upon request



BERGSTIK® UNSHROUDED CONTINUOUS HEADERS

APPLICATION

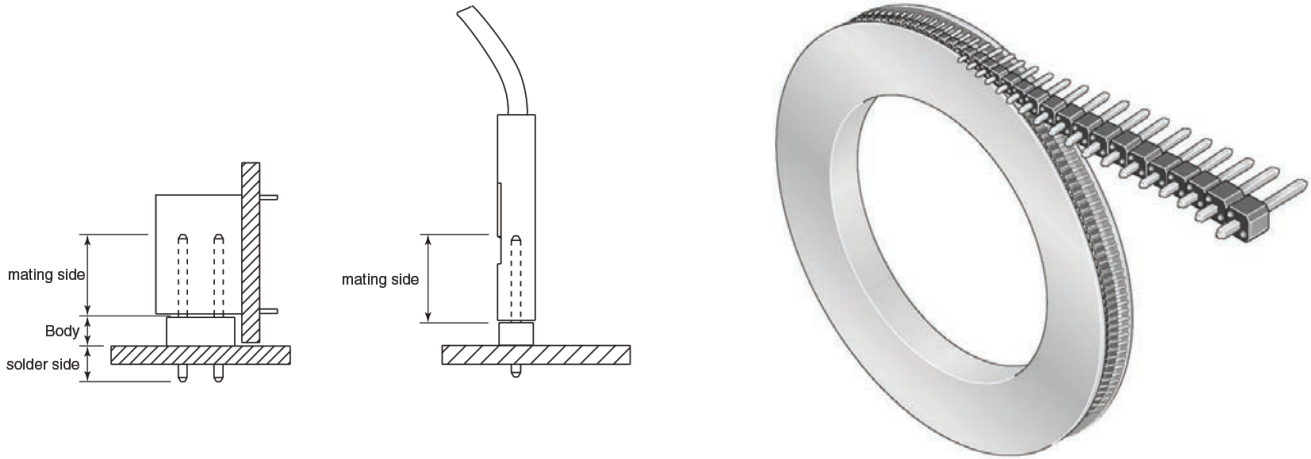

PRODUCT

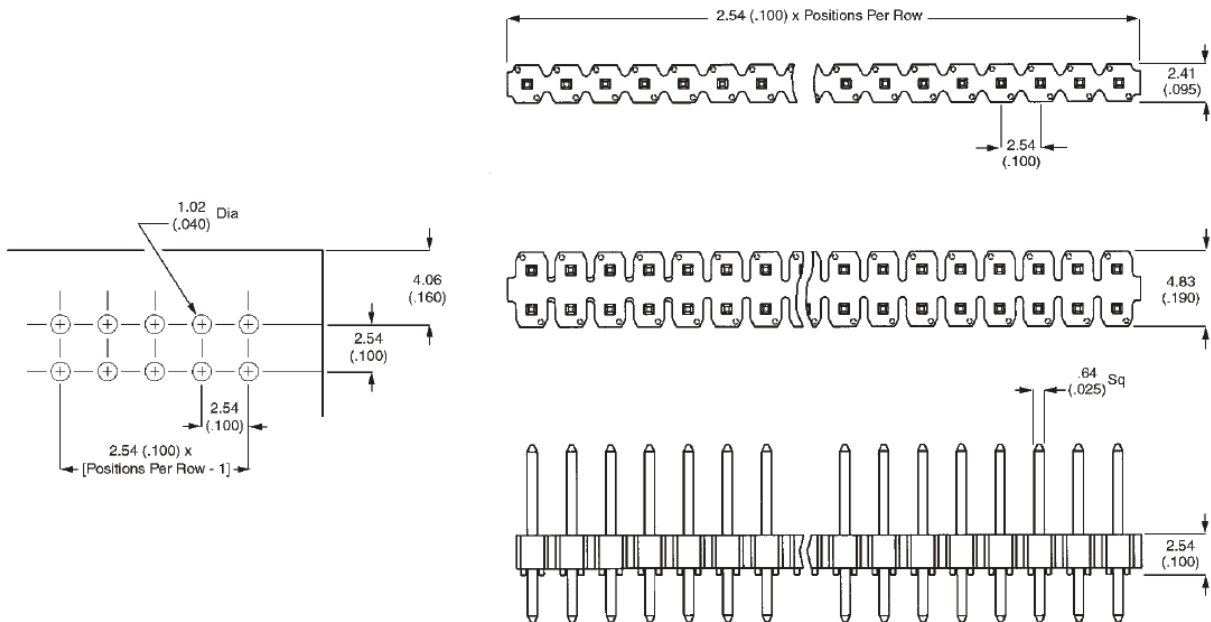

Recommended PCB Layouts

Dimension in mm

TECHNICAL INFORMATION

MATERIALS

- Housing: High temperature thermoplastic, Black
- Flammability Rating: UL94V-0
- Pin: Phosphor-bronze
- Plating: Gold or Tin over 1.27µm (50µin.) Nickel

ELECTRICAL PERFORMANCE

- Current Rating: 3A per contact
- Insulation Resistance: 5000MΩ min
- Dielectric Withstanding Voltage: 1500V

ENVIRONMENTAL PERFORMANCE

- Operating Temperature: -65°C to +125°C

MECHANICAL PERFORMANCE

- Retention Force: 9N min.

SPECIFICATIONS

- File no. E66906
- File no. LR46923
- Product Drawing: 54101/ 54102/ 77311/ 77313
- Product Specification: BUS-12-059

APPROVALS AND CERTIFICATIONS

- RoHS compatible according to the European Union Directive 2002/95/IEC

PACKAGING

- Reel

PROCESSING INFORMATION

- Compatible with wave, vapor-phase, and IR reflow soldering processes

PART NUMBER SELECTOR

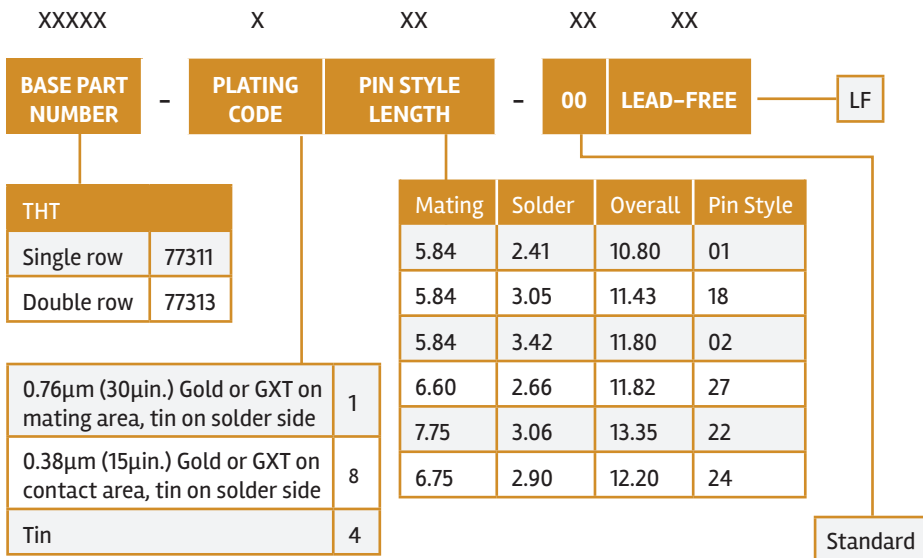

BERGSTIK® UNSHROUDED RIGHT ANGLE HEADERS STANDARD SIZES

APPLICATION

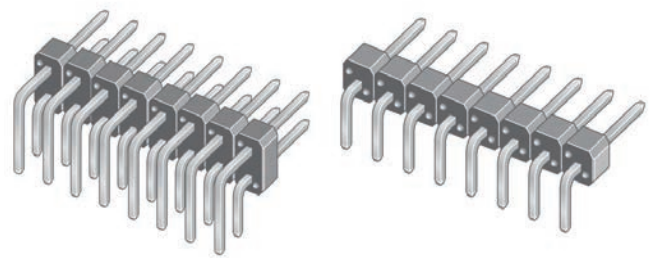
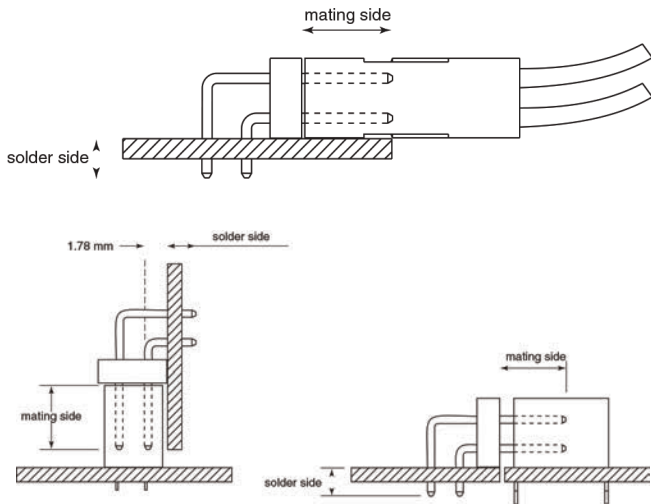

PRODUCT

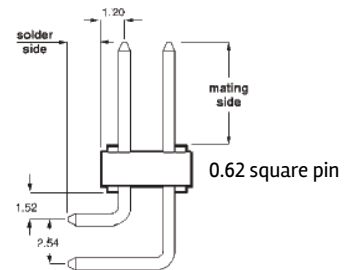
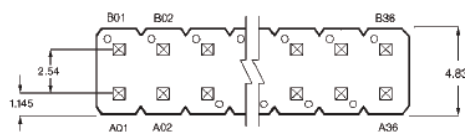
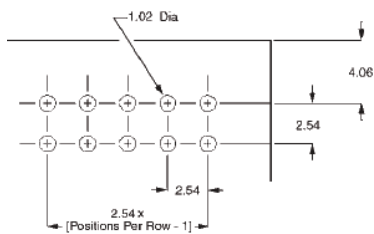
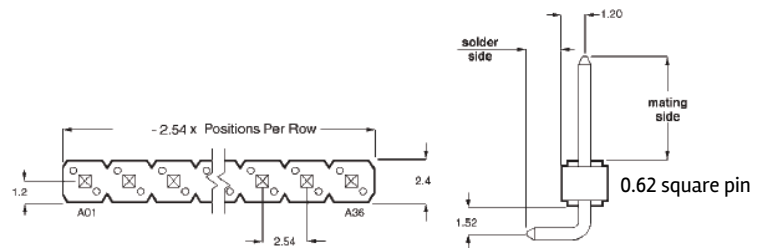

Recommended PCB Layouts

Dimension in mm

TECHNICAL INFORMATION

MATERIALS

- Housing: High temperature thermoplastic, Black
- Flammability Rating: UL94V-0
- Pin: Phosphor-bronze
- Plating: Gold or Tin over 1.27µm (50µin.) Nickel

ELECTRICAL PERFORMANCE

- Current Rating: 3A per contact
- Insulation Resistance: 5000MΩ min
- Dielectric Withstanding Voltage: 1500V

ENVIRONMENTAL PERFORMANCE

- Operating Temperature: -65°C to +125°C

MECHANICAL PERFORMANCE

- Retention Force: 9 N min.

SPECIFICATIONS

- File no. E66906
- File no. LR46923
- Product Drawing: 77315/ 77317
- Product Specification: BUS-12-114

APPROVALS AND CERTIFICATIONS

- RoHS compatible according to the European Union Directive 2002/95/IEC

PACKAGING

- Bags

PROCESSING INFORMATION

- Compatible with wave, vapor-phase, and IR reflow soldering processes

PART NUMBER SELECTOR



BERGSTIK® UNSHROUDED RIGHT ANGLE HEADERS SPECIAL SIZES

APPLICATION

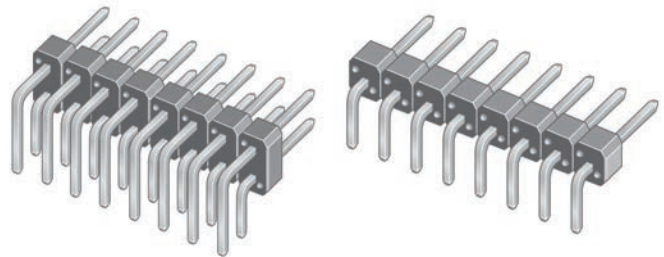
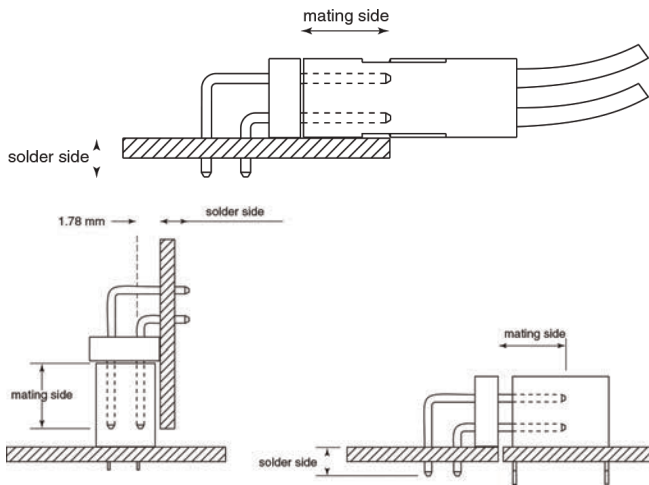

PRODUCT

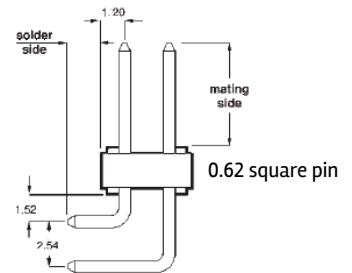
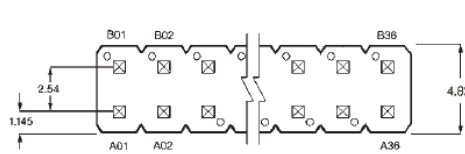
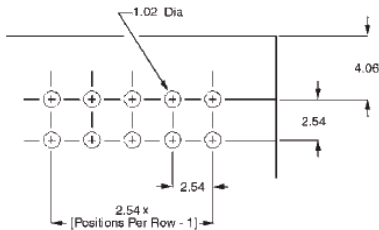
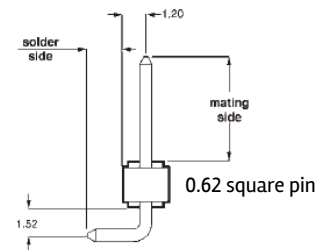
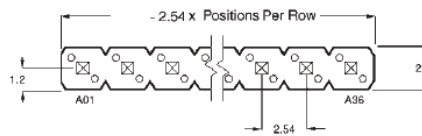

Recommended PCB Layouts

Dimension in mm

TECHNICAL INFORMATION

MATERIALS

- Housing: High temperature thermoplastic, Black
- Flammability Rating: UL94V-0
- Pin: Phosphor-bronze
- Plating: Gold or Tin over 1.27µm (50µin.) Nickel

ELECTRICAL PERFORMANCE

- Current Rating: 3A per contact
- Insulation Resistance: 5000MΩ min
- Dielectric Withstanding Voltage: 1500V

ENVIRONMENTAL PERFORMANCE

- Operating Temperature: -65°C to +125°C

MECHANICAL PERFORMANCE

- Retention Force: 9N min.
- Retentive Leg Insertion Force: >44.48N max.
- Retentive Leg Board Retention: 2.22N

SPECIFICATIONS

- File no. E66906
- File no. LR46923
- Product Drawing: 55101/ 55102/ 68015/ 68020
- Product Specification: BUS-12-114

APPROVALS AND CERTIFICATIONS

- RoHS compatible according to the European Union Directive 2002/95/IEC

PACKAGING

- Bags

PROCESSING INFORMATION

- Compatible with wave, vapor-phase, and IR reflow soldering processes

PART NUMBER SELECTOR

Customize your own part number using custom dimensions (Please allow for initial setup on our system)

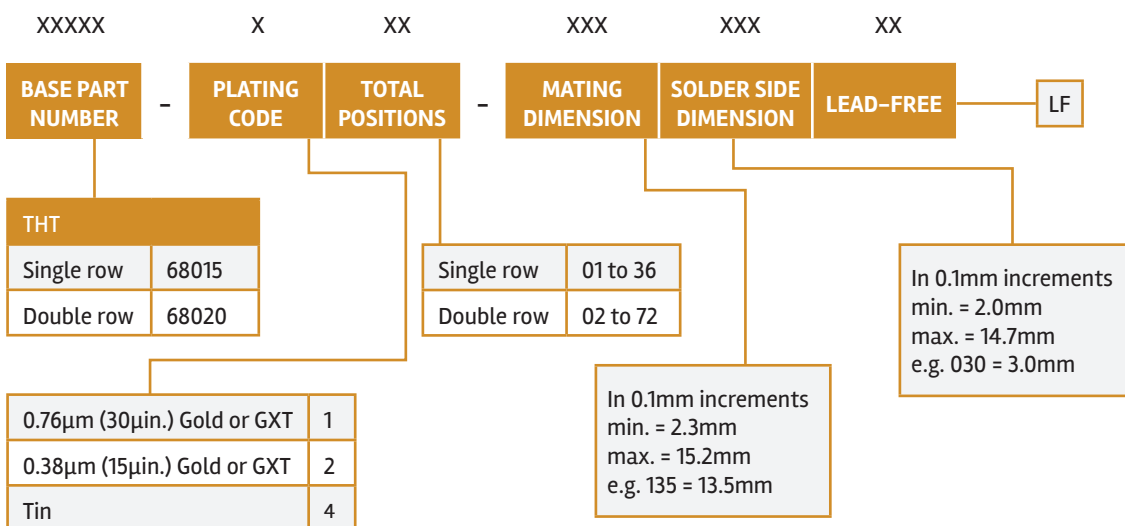

Note: 1. Bend dimension 1.52mm only
2. The total combined dimension for mating and solder side may not exceed 25.5mm



BERGSTIK® UNSHROUDED STACKING HEADERS

APPLICATION

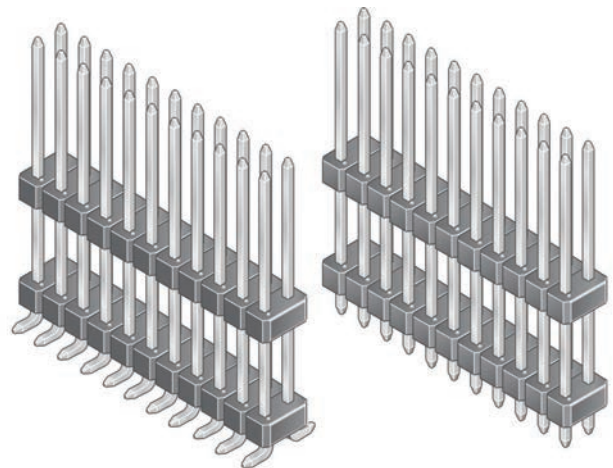
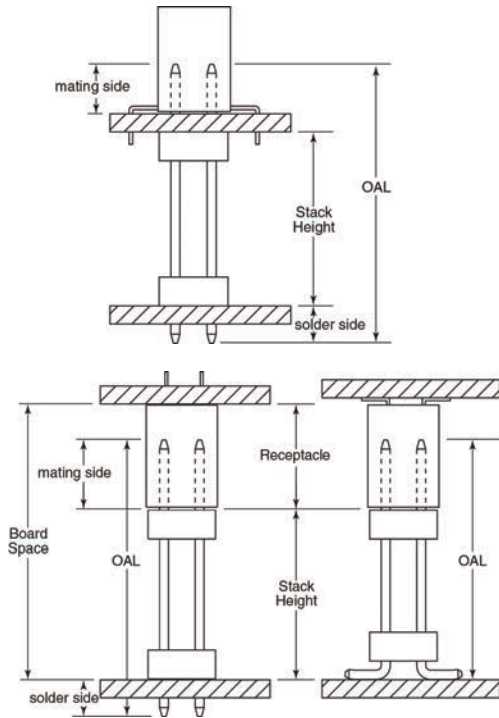
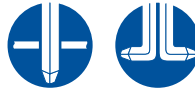

Board spacing = stack height of header+ height of the receptacle (See application drawings on next page)

PRODUCT

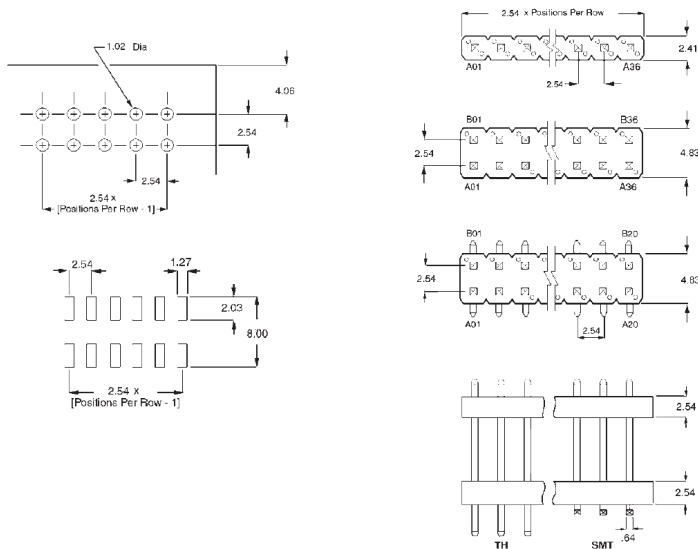

Recommended PCB Layouts

Dimension in mm

TECHNICAL INFORMATION

MATERIALS

- Housing: High temperature thermoplastic, Black
- Flammability Rating: UL94V-0
- Pin: Phosphor-bronze
- Plating: Gold or Tin over 1.27µm (50µin.) Nickel

ELECTRICAL PERFORMANCE

- Current Rating: 3A per contact
- Insulation Resistance: 5000MΩ min
- Dielectric Withstanding Voltage: 1500V

ENVIRONMENTAL PERFORMANCE

- Operating Temperature: -65°C to +125°C

MECHANICAL PERFORMANCE

- Retention Force: 9N min.

SPECIFICATIONS

- File no. E66906
- File no. LR46923
- Product Drawing: By 5-digit base part number
- Product Specification: BUS-12-114

APPROVALS AND CERTIFICATIONS

- RoHS compatible according to the European Union Directive 2002/95/IEC

PACKAGING

- Bags

PROCESSING INFORMATION

- Compatible with wave, vapor-phase, and IR reflow soldering processes

PART NUMBER SELECTOR

Customize your own part number using custom dimensions (Please allow for initial setup on our system)

XX X X X X XX XX XXXX XX

54	LEAD	SOLDER SIDE DIMENSION	ROW OPTION	-	PLATING CODE	PIN STYLE LENGTH	TOTAL POSITIONS	STACK HEIGHT	LEAD-FREE	LF
	THT 1 SMT 2	2.41mm 1 3.05mm 2	Single row (THT only) 1 Double row 2		0.76µm (30µin.) Gold or GXT on contact area, tin on solder side 0.38µm (15µin.) Gold or GXT on contact area, tin on solder side	1 8		XX.XX = mm Specify mm i.e. 08.50 = 8.50mm in 0.50mm increments		
	SMT (double row only) 4							08.00 min. - 25.00 max. THT 09.50 min. - 26.00 max. SMT		
								Single row (THT) 02 to 36 Double row (THT) 04 to 72 Double row (SMT) 04 to 50		

Overall* THT	Overall* SMT	Pin Style
12.20	10.42	01
13.50	11.72	02
15.90	14.12	03
6.76	14.98	04
17.65	15.87	05
18.91	17.13	06
20.96	19.18	07
23.50	21.72	08
26.04	24.26	09
28.58	26.80	10
31.12	29.34	11
33.66	31.88	12

*Other overall lengths available upon request (Up to 65mm)



www.fci.com

For more information, please contact: communications@fci.com