



# A NEW UNIVERSAL AC POWER PROTECTION APPROACH

## WHITE PAPER



Bourns® IsoMOV™ Hybrid Protectors



Bourns® SinglFuse™ SMD Fuses

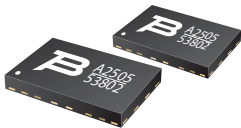

Bourns® TBU® High-Speed Protectors (HSPs)

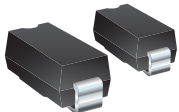

Bourns® TISP® Thyristor Surge Protectors



### INTRODUCTION

Lightning surges and power disturbances on AC mains can have a detrimental effect on a wide range of electronic equipment. The damage caused by overvoltage and overcurrent events can result in costly down time and repair costs and contribute to low customer confidence in the manufacturer.

What is needed is a new approach to AC power input protection that gives developers the option to integrate a robust, on-demand protection circuit. Using this type of protection methodology offers minimal interference during an application's normal operation, which can reduce component degradation over time to help extend the equipment's lifespan.

This white paper introduces a coordinated circuit protection methodology that employs a new hybrid protector. It presents the special features delivered in a new universal AC power protection solution and covers Bourns lab tests on simulated AC line swells and lightning. Multiple application examples are provided that highlight how the new level of protection can be achieved to help maximize reliability and reduce downtime.

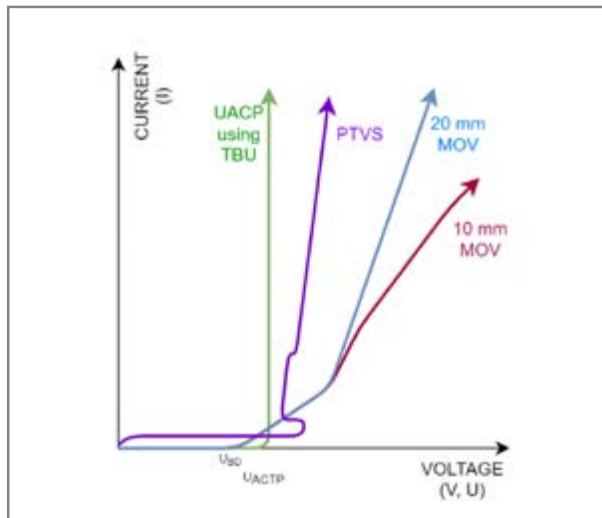
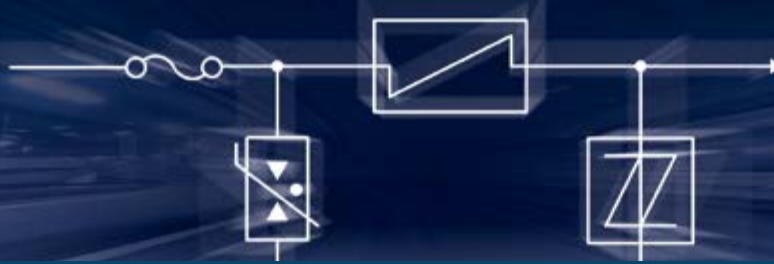

Figure 1 - Universal AC Power Protection Residual Voltage Compared to Varistors

Comparing the residual voltage of the universal AC power protection with 14 mm and 20 mm MOVs shows that the voltage does not increase with current as it does with the varistors.

This comes about by carefully coordinating a group of circuit protection components so that each component protects the ones next to it.



## A NEW UNIVERSAL AC POWER PROTECTION APPROACH



Bourns® IsoMOV™ Hybrid Protectors



Bourns® SinglFuse™ SMD Fuses



Bourns® TBU® High-Speed Protectors (HSPs)



Bourns® TISP® Thyristor Surge Protectors

### FEATURE REQUIREMENTS FOR UNIVERSAL AC POWER PROTECTION

Currently, there is no overcurrent and overvoltage protection solution that exists that can deliver universal power to help equipment designers meet safety requirements. This requires a solution that offers absolute maximum voltage protection, regardless of the intensity of the surge input, in order to reduce design margin requirements and the associated costs of downstream circuit components. The ideal circuit protection approach needs to automatically reset every half cycle to provide continuous protection when needed. For universal AC power protection, the optimal surge protector would also have to limit power let-through to prevent fires in case of component failure or damage.

To meet these requirements, Bourns has engineered a new hybrid protector, the IsoMOV™ device. The Bourns® IsoMOV™ device is designed to be a coordinated self-protecting solution working in conjunction with Bourns® SinglFuse™ SMD fuse, TBU® high-speed protector (HSP) and TISP® thyristor surge protector components. Ideal for mission-critical applications where failure is not acceptable or service is difficult, this coordinated approach conditions AC power delivered in certain harsh environments to protect equipment from voltage spikes, swells or overvoltages. The protection scheme that employs the Bourns® IsoMOV™ component helps to increase reliability, improve system up-time and contribute to reduced lifecycle costs and warranty issues.



# A NEW UNIVERSAL AC POWER PROTECTION APPROACH

## PROTECTION CIRCUIT OPERATIONAL BASICS

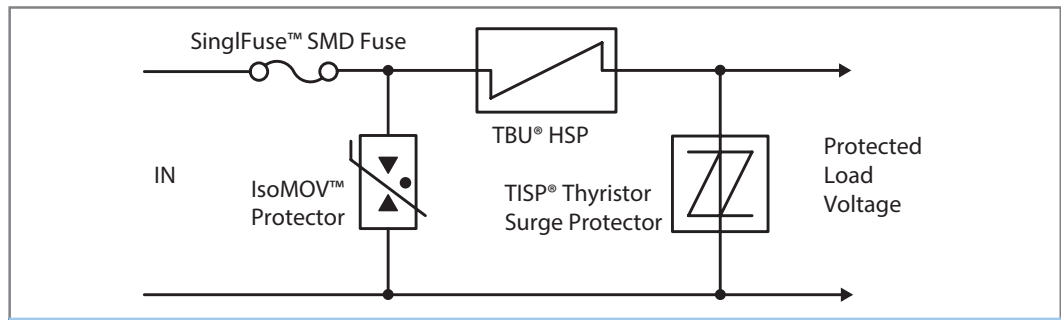

Figure 2 - Universal AC Power Protection Circuit Diagram

Figure 2 shows a basic schematic of the protection circuit. Line power is applied at the left-side port and the protected equipment is connected to the right-side port. The operation of the circuit is best described moving from right to left – starting with the TISP® device.

The TISP® device shown is a thyristor that is triggered if the voltage across the protected load should exceed its breakdown voltage rating. Important in selecting a TISP® device is its breakdown voltage, which is key in preventing damage caused by excessive voltage in the protected circuit. This allows precise selection of the maximum voltage necessary to protect the specified circuit.

The following lists the series of steps in the universal AC power protection scheme:

1. If a voltage event should trip the **TISP® device**, it will short out the AC line. The excessive current drawn will trip the Bourns® TBU® high-speed protector (HSP) device into its blocking state. When the TBU® HSP blocks the excessive current, the protected load and TISP® device are essentially disconnected from the AC line, protecting both from damage.
2. As the **TBU® HSP** blocks the current, the input voltage may continue to rise until the Bourns® IsoMOV™ hybrid protector trips and limits the voltage below the TBU® HSP's maximum blocking voltage rating.
3. Should the voltage continue to rise until the current through the **IsoMOV™ device** exceeds the device's surge rating, the Bourns® SinglFuse™ device will open and permanently disconnect the circuit from the AC line.

Secondarily, if the protected load attempts to draw in excess of the TBU® HSP's trip current, the device will go into the blocking state and the circuit will behave as before (Steps 2 and 3).

When the AC input voltage crosses zero, the circuit resets to the initial state and can either resume normal operation (typical for a lightning surge) or be tripped again on the next half cycle (typical for a voltage swell).



Bourns® IsoMOV™ Hybrid Protectors



Bourns® SinglFuse™ SMD Fuses



Bourns® TBU® High-Speed Protectors (HSPs)

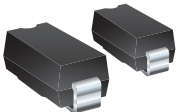

Bourns® TISP® Thyristor Surge Protectors





## A NEW UNIVERSAL AC POWER PROTECTION APPROACH



Bourns® IsoMOV™ Hybrid Protectors



Bourns® SinglFuse™ SMD Fuses



Bourns® TBU® High-Speed Protectors (HSPs)



Bourns® TISP® Thyristor Surge Protectors

### AC LINE VOLTAGE SWELL RESPONSE

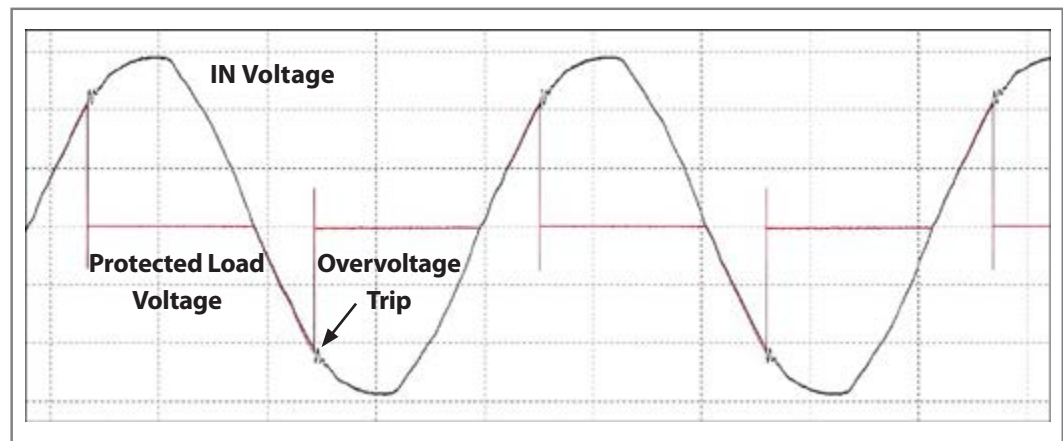

Figure 3- Illustration of Universal AC Power Protection Operation with AC Line Voltage Swell

Figure 3 shows the response of the circuit to an AC line voltage swell. The TISP® device employed activates about 220 V – a typical value selected for nominal 120 VAC power lines. The swell voltage applied is set to about 200 VAC. As shown above, the input and output voltages track until the TISP® protector fires, at which time the load voltage drops to zero for the remainder of each half-cycle.

Later we will show that protected switched-mode power supplies (SMPS) loads we tested continued to operate during these voltage swells.





## A NEW UNIVERSAL AC POWER PROTECTION APPROACH

### LIGHTNING TRANSIENT RESPONSE



Bourns® IsoMOV™ Hybrid Protectors



Bourns® SinglFuse™ SMD Fuses



Bourns® TBU® High-Speed Protectors (HSPs)



Bourns® TISP® Thyristor Surge Protectors

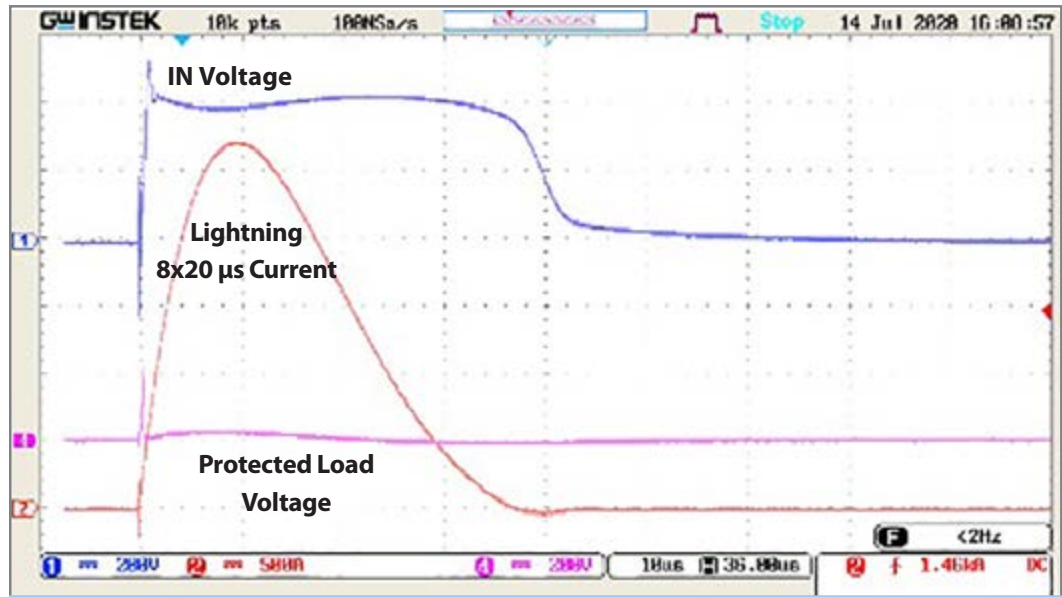

Figure 4- Circuit Response to a 6 kV 8x20  $\mu$ s Lightning Transient

Figure 4 illustrates the response of the circuit to an IEC 61000-4-5 simulated lightning pulse of 6000 V with an 8x20  $\mu$ s waveshape. Such lightning surges last only about 50  $\mu$ s. Switching transients and other impulse-like line noise are typically even shorter in duration. It should be noted that these particular tests were not performed on an AC line. In real-world applications, the TBU® HSP, once put into the blocking state by lightning or some other transient, will continue in its blocking state until the next power line zero crossing.

The oscilloscope in Figure 4 shows that the IN voltage is clamped at about 400 V by the Bourns® IsoMOV™ device. The generator sources the current from a capacitor charged to 6000 V. The driving voltage for the current is then 6000 V minus 400 V or 5600 V. Since the generator has a characteristic impedance of 2 ohms, the peak current of about 2800 A is the expected value.



# A NEW UNIVERSAL AC POWER PROTECTION APPROACH

## LIGHTNING TRANSIENT RESPONSE (Continued)



Bourns® IsoMOV™ Hybrid Protectors



Bourns® SinglFuse™ SMD Fuses



Bourns® TBU® High-Speed Protectors (HSPs)



Bourns® TISP® Thyristor Surge Protectors

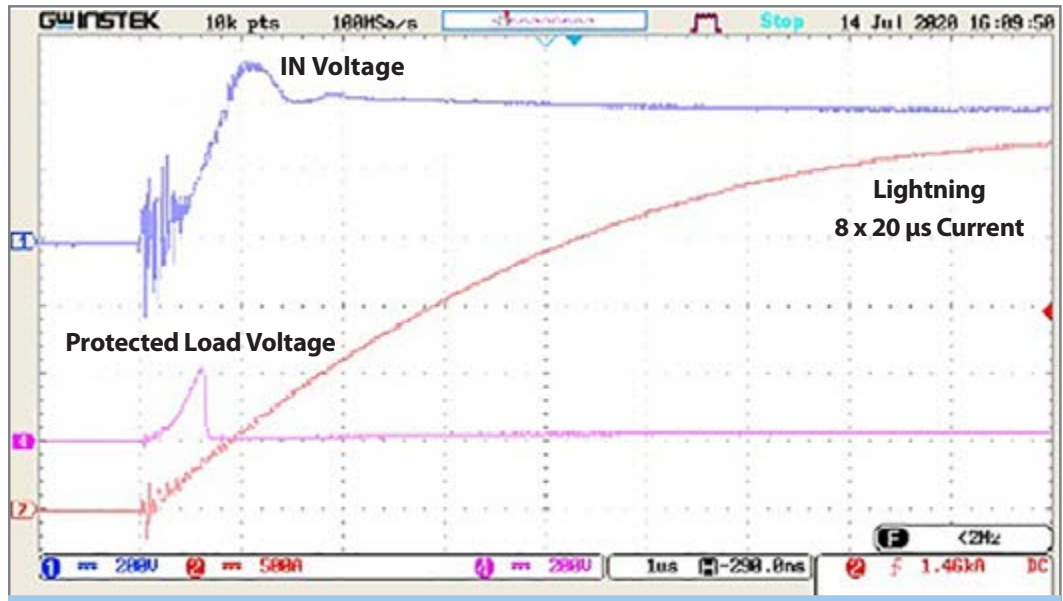

Figure 5. Circuit Response to a 6 kV 8x20  $\mu$ s Lightning Transient – Detailed View

Figure 5 displays the same waveform of Figure 4, but with a timescale of 1  $\mu$ s/div, which translates to a 10X view of the details of the lightning transient response. The waveform in Channel 4 shows the response of the TISP® device to the overvoltage event. Some ringing is evident in these measurements. The ringing in Channel 1 is largely caused by the switching action of the surge generator interacting with the high voltage scope probe. Note that ringing is not evident in Channel 4 (at the protected load). Also some of the ringing that appears in Channel 1 is a reaction by the transformer driving the AC voltage when the TBU® HSP suddenly switches to its blocking state.

The key takeaway from this test is that in the face of a rather severe lightning event, the peak voltage experienced by the protected load is only about 230 V.





## A NEW UNIVERSAL AC POWER PROTECTION APPROACH

### APPLICATION: STREETLIGHT VOLTAGE SWELL

A 150 W LED streetlight luminaire (LEDMyPlace.com #719034339818) with a switch mode power controller and dimming function is set to a power level of about 50 watts.



Bourns® IsoMOV™ Hybrid Protectors



Bourns® SinglFuse™ SMD Fuses



Bourns® TBU® High-Speed Protectors (HSPs)



Bourns® TISP® Thyristor Surge Protectors

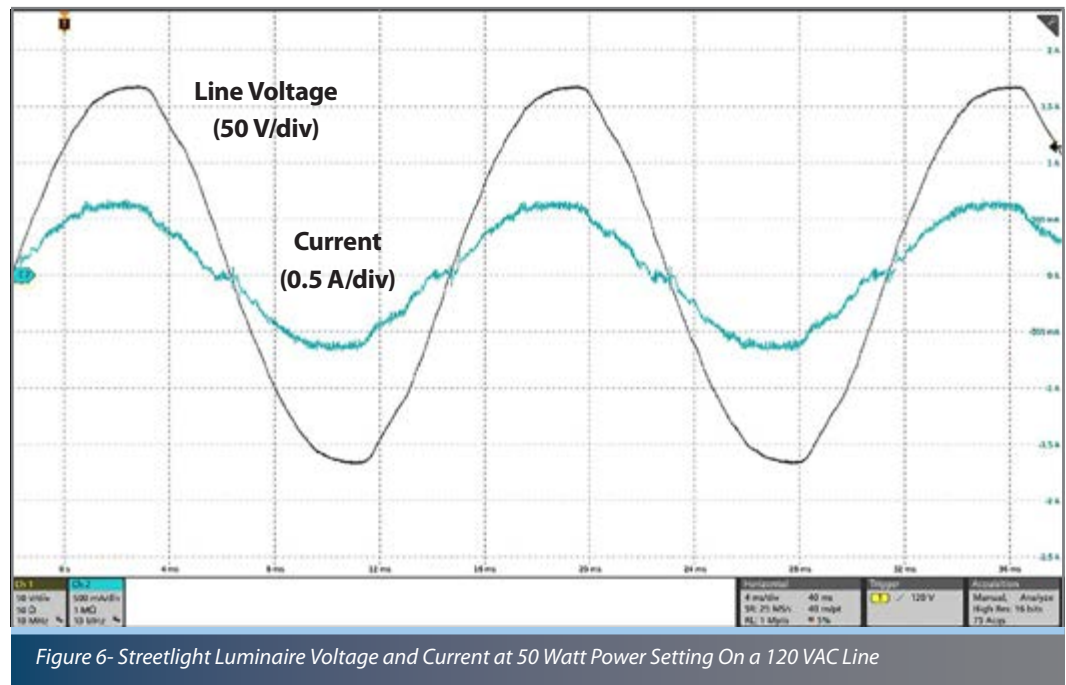
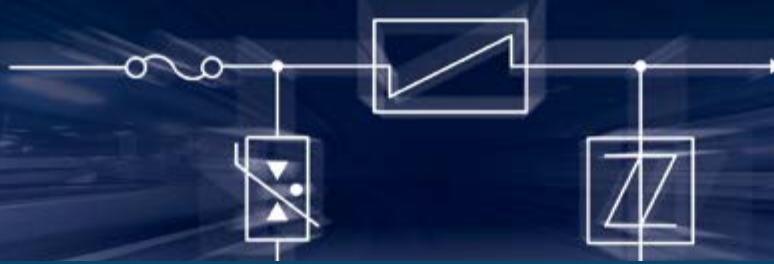

Figure 6 shows the voltage and current waveforms from a 120 VAC mains AC supply. The luminaire current is nearly sinusoidal with little power drawn between the current zero crossing and the voltage zero crossing. The load appears slightly capacitive in nature. The peak current draw is approximately 600 mA.





## A NEW UNIVERSAL AC POWER PROTECTION APPROACH

### APPLICATION: STREETLIGHT VOLTAGE SWELL (Continued)



Bourns® IsoMOV™ Hybrid Protectors



Bourns® SinglFuse™ SMD Fuses

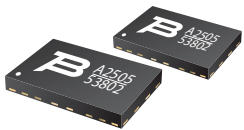

Bourns® TBU® High-Speed Protectors (HSPs)



Bourns® TISP® Thyristor Surge Protectors

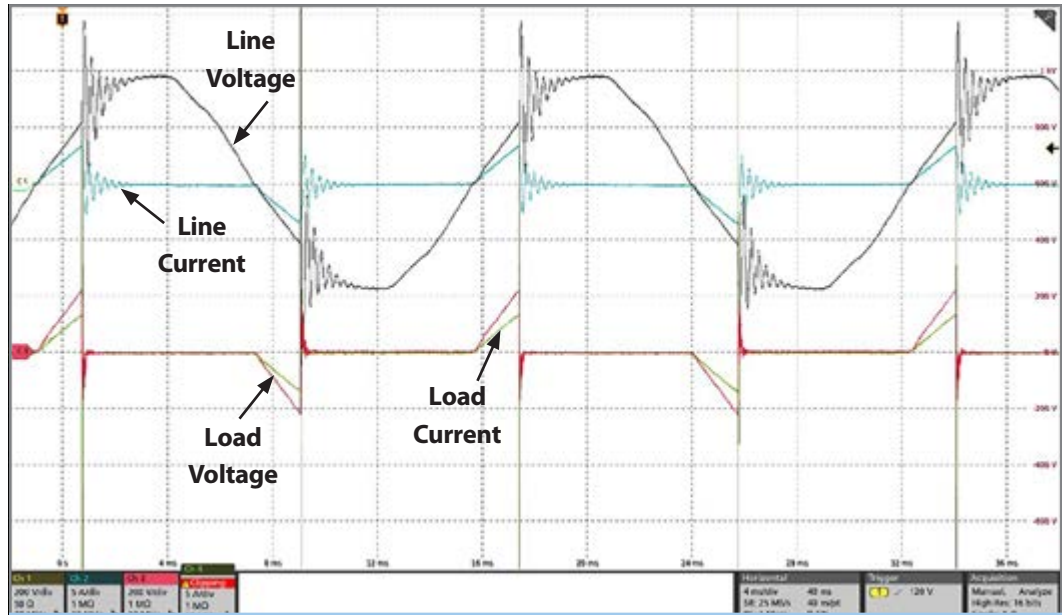

Figure 7- Streetlight Luminaire Voltages and Currents at 50 Watt Power Setting on a Protected 277 VAC Line

Figure 7 shows the luminaire at the same power setting driven at 277 VAC with the protection circuit in place (using the same approximately 220 V TISP® device). The power to the luminaire can be seen to be cut off at about 210 V. When tested in the Bourns lab, some ringing on the AC line was evident when the lab power transformer inductance reacts with the sudden current blocking action from the TBU® HSP.

Note that the luminaire drew large currents (the 0 to 3 A ramp) before the TISP® device triggered. At the TBU® HSP trigger point on each peak of each half-cycle, it drew about 600 W! As previously noted, under normal line conditions the luminaire drew about 600 mA peak on a near sinusoidal wave.

In this test, the luminaire light output appeared to be unaffected by the voltage swell.





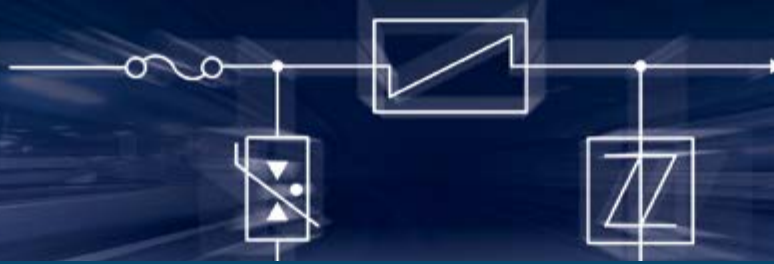

## A NEW UNIVERSAL AC POWER PROTECTION APPROACH

### APPLICATION: COMPUTER POWER SUPPLY

A common laptop computer power supply rated at 64 watts output with 90 to 240 VAC input is operated with a resistive load drawing 43 watts.



Bourns® IsoMOV™ Hybrid Protectors



Bourns® SinglFuse™ SMD Fuses



Bourns® TBU® High-Speed Protectors (HSPs)



Bourns® TISP® Thyristor Surge Protectors

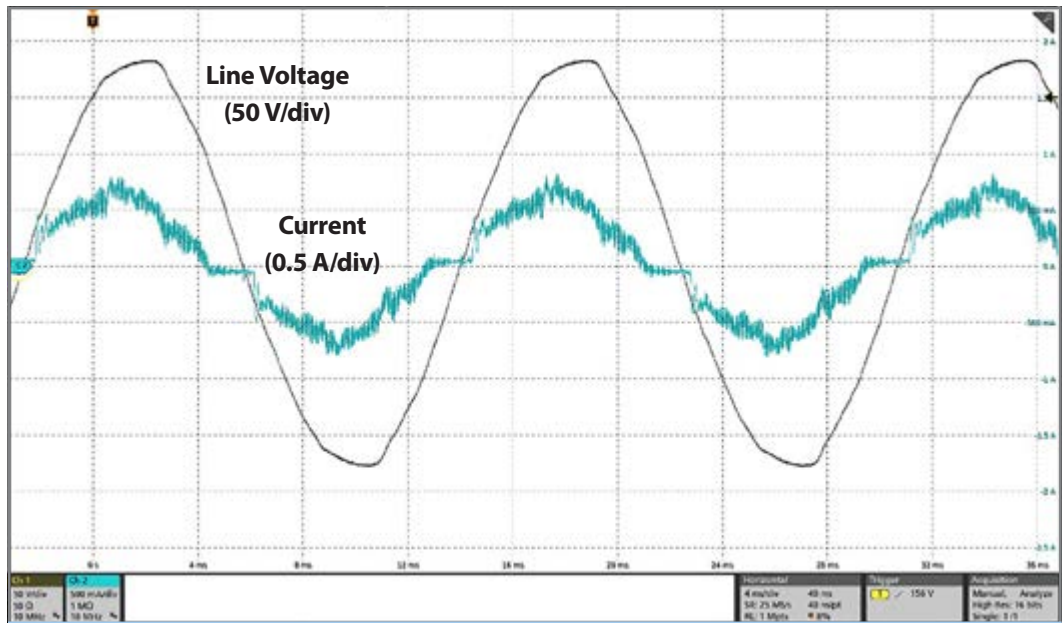
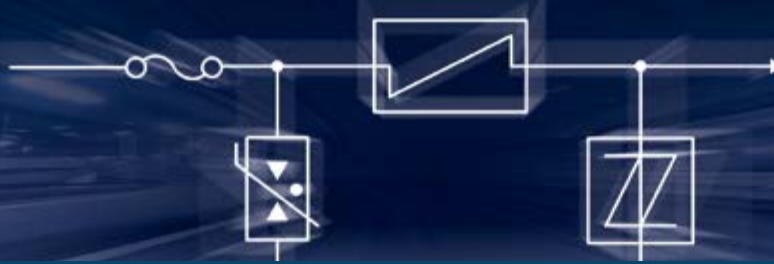

Figure 8- 64 Watt Computer Power Supply Voltage and Current at 43 Watt Load On a 120 VAC Line

Figure 8 illustrates the voltage and current waveforms from a 120 VAC mains AC supply. The power supply current is nearly sinusoidal with a dropout between the current zero crossing and the voltage zero crossing. The load appears slightly capacitive in nature. The peak current draw is about 700 mA.





## A NEW UNIVERSAL AC POWER PROTECTION APPROACH

### APPLICATION: COMPUTER POWER SUPPLY (Continued)



Bourns® IsoMOV™ Hybrid Protectors



Bourns® SinglFuse™ SMD Fuses



Bourns® TBU® High-Speed Protectors (HSPs)



Bourns® TISP® Thyristor Surge Protectors

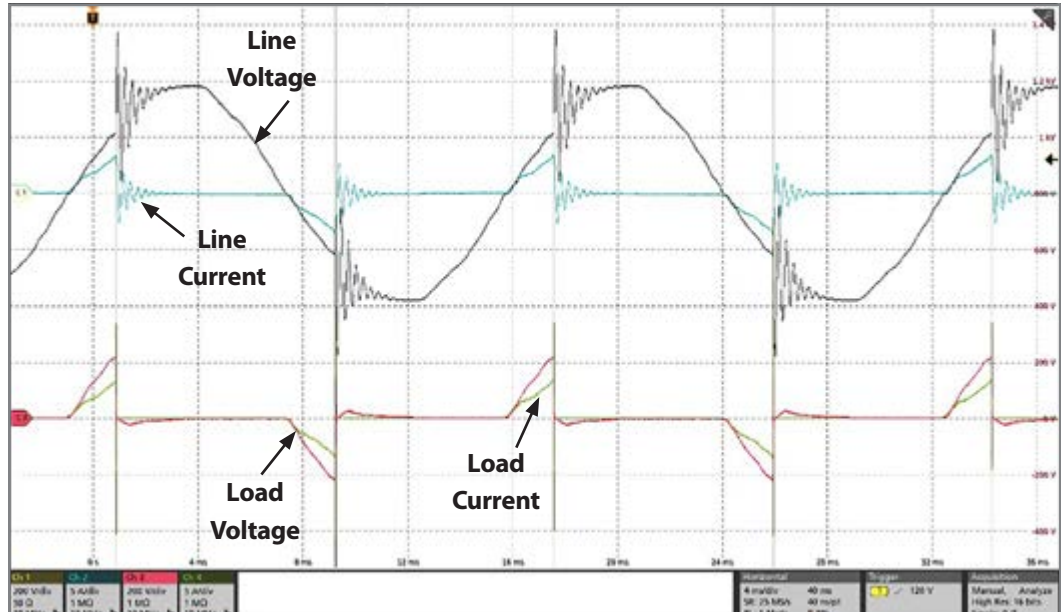

Figure 9 - 64 Watt Computer Power Supply Voltages and Currents at 43 Watt Load On a Protected 277 VAC Line

Figure 9 shows the computer power supply with the same 43 watt load driven at 277 VAC with the protection circuit in place (using the same approximately 220 V TISP® device). During the test in the Bourns lab, the voltage to the power supply can be seen to be cut off at about 210 V. Ringing on the AC line was evident again as the lab power transformer inductance reacts with the sudden current blocking action from the TBU® HSP.

Note that in the Bourns test, the power supply drew large currents (the 0 to 3 A ramp) before the TISP® device triggered. At the TBU® HSP trigger point on each peak of each half-cycle, it drew about 600 W! And as previously noted under normal line conditions, the power supply drew 700 mA peak on a near sinusoidal wave which is controlled by the current blocking action of the TBU® HSP.

The power supply operation appeared to unaffected otherwise by the voltage swell.





## A NEW UNIVERSAL AC POWER PROTECTION APPROACH



Bourns® IsoMOV™ Hybrid Protectors



Bourns® SinglFuse™ SMD Fuses



Bourns® TBU® High-Speed Protectors (HSPs)



Bourns® TISP® Thyristor Surge Protectors

### TBU® HSP RESISTANCE AND EFFICIENCY TRADEOFFS

In the active AC protector circuit, the TBU® HSP is in series resistance. For prototype purposes, the Bourns lab setup used four Bourns® TBU-CA085-500-WH devices in parallel. Each of these has a nominal trip current of 750 mA, a resistance of 10.7 ohms and a standoff voltage of 850 V. This yields a composite device of about 3 A trip current and 2.7 ohms of resistance.

There is a natural tradeoff in the protection circuit between cost and additional value provided by a TBU® HSP's resistance. The trip current is of little concern provided it is enough to support the inrush and operating currents of the protected load. When the TISP® device is triggered, the available short-circuit current from the AC line will instantly trip the TBU® HSP.

The resistance of the TBU® HSP can cause continuous power losses as seen in Figures 10 and 11. Note that the higher peak currents encountered in the clipping "protection mode" will tend to cause more loss compared with the near sinusoidal currents experienced in normal operation.

The design engineer is then faced with finding an acceptable balance of cost and efficiency.

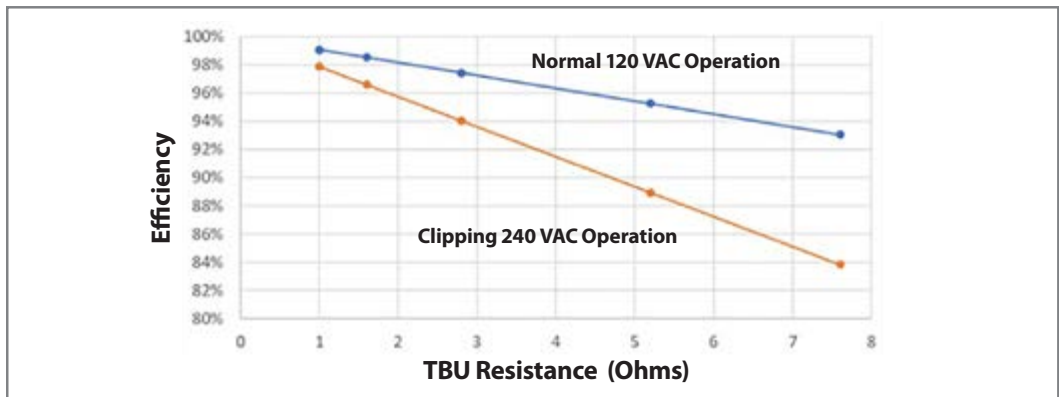

Figure 10 - AC Protector Efficiency for the Streetlight Luminaire at 50 Watts

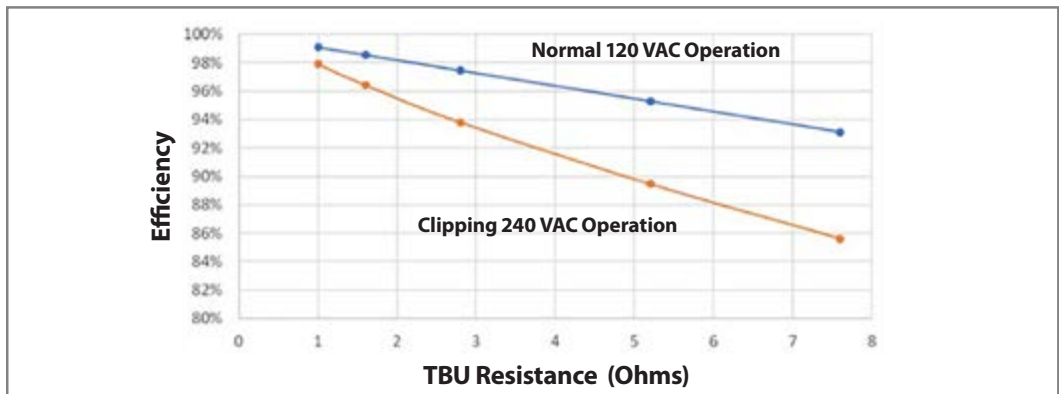
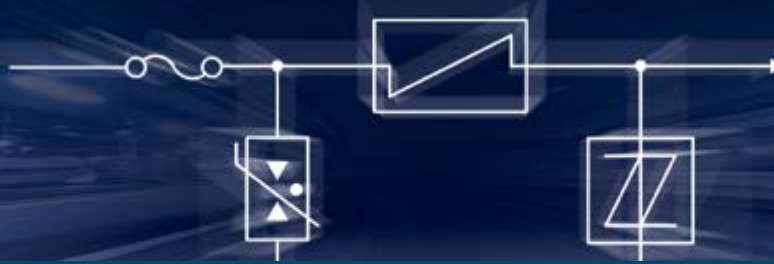

Figure 11 - AC Protector Efficiency for the Computer Power Supply Loaded to 43 Watts





## A NEW UNIVERSAL AC POWER PROTECTION APPROACH

### CONCLUSION

Using the SinglFuse™ SMD fuse together with the IsoMOV™ hybrid protector, this Universal AC Protection design provides continuously available protection in four small components. This protection was previously unattainable using much larger components that included disconnecting the overvoltage protection and the risk of fire and destruction.

Bourns supplies the cutting-edge components to enable this AC line input protection in a space less than one square inch. The protection components are exactly coordinated together so they protect each other and the designer's load from lightning surges, AC line noise, AC line surges, and any other overvoltage condition that would otherwise reach the user's equipment.



Bourns® IsoMOV™ Hybrid Protectors



Bourns® SinglFuse™ SMD Fuses



Bourns® TBU® High-Speed Protectors (HSPs)



Bourns® TISP® Thyristor Surge Protectors



[www.bourns.com](http://www.bourns.com)

COPYRIGHT© 2021 • BOURNS, INC. • 06/21 • e/GDT2025

"Bourns", "TBU" and "TISP" are registered trademarks of Bourns, Inc. in the U.S. and other countries. "SinglFuse", "TBU" and "IsoMOV" are registered service marks of Bourns, Inc. in the U.S. and other countries.

**BOURNS®**

Americas: Tel +1-951 781-5500  
Email [americus@bourns.com](mailto:americus@bourns.com)

EMEA: Tel +36 88 885 877  
Email [euocus@bourns.com](mailto:euocus@bourns.com)

Asia-Pacific: Tel +886-2 256 241 17  
Email [asiacus@bourns.com](mailto:asiacus@bourns.com)