

## Power Management for Industry 4.0 and IoT applications

Industry 4.0 has sparked one of the most significant demand streams for high-end technologies with systems implementing increasingly advanced IoT deliverables.

The same key IoT technologies are expected to come together in many different applications, to the point that sensors, microcontrollers and connectivity devices will become mainstay components across the majority of industrial applications, with many block diagrams and BOMs converging over a wide range of solutions.

ST's IoT range can satisfy the full BOM requirements of comprehensive industrial systems, such as the turnkey condition monitoring solution figured below.

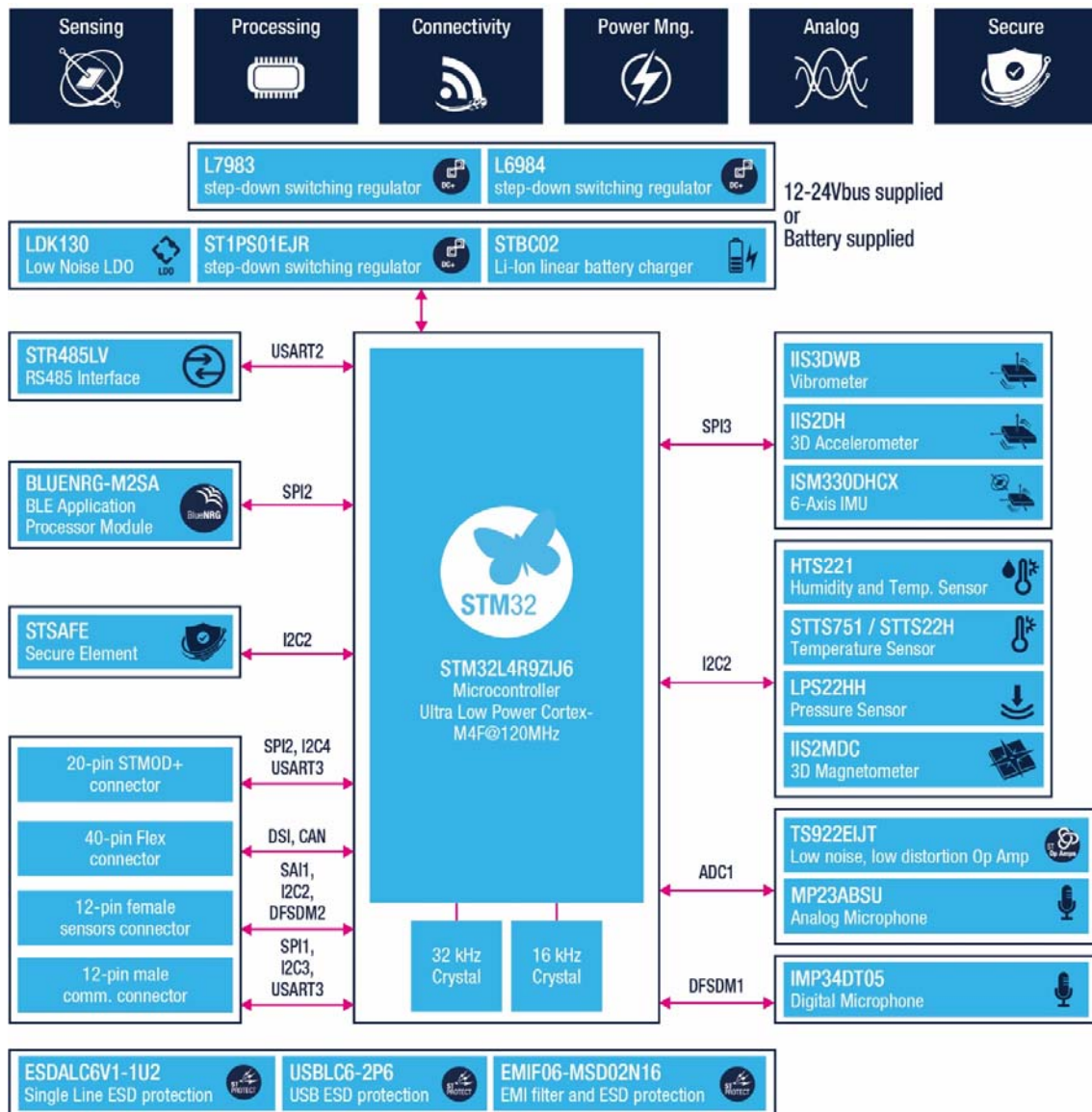


Fig. 1. Condition Monitoring turnkey solution

Power management solutions for such comprehensive ecosystems need to satisfy both the power requirements of the peripherals and final application performance targets, so dedicated power management ICs must deliver a wide range of features and premium performance.

The L7983 is a perfect choice for smart industry applications, as it offers a compact 3.5V-60V, 300mA synchronous DC/DC buck converter solution with flexible dynamic-mode selection for noise-sensitive applications and high efficiency at light load. Its wide input-voltage range allows the L7983 to operate on 12V and 24V industrial buses with a generous safety margin and can also manage 48V applications. The converter is well suited to battery-powered applications and is suitable for use in industrial fail-safe systems, decentralized intelligent nodes, appliances, robotics, telecom equipment, and precision-sensing applications, which can take full advantage of the low-noise mode.

The collection of sensors, microcontrollers and connectivity ICs can be supplied with same Voltage value or diversified to exploit performance opportunities. Either way, the noise friendly architecture and the inherent wide spectrum capability allow both.

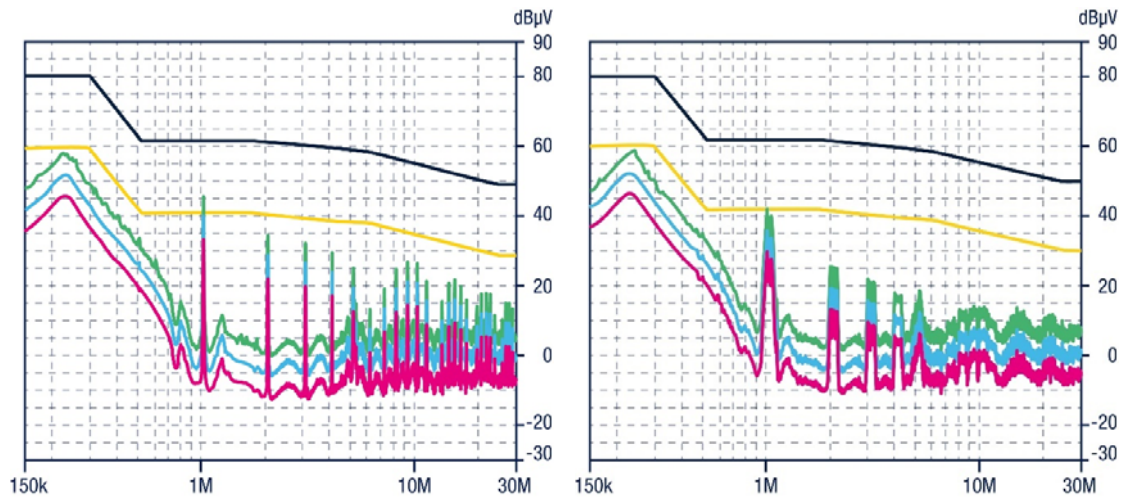
The figure below shows a typical ultra-low quiescent complete power management solution with additional noise immunity allocated to the RF subsystem.



**Fig. 2.** Power management tree for 24V-36V Battery Pack Smart Industry systems

In terms of EMI, the L7983 offers on-the-fly selection between forced PWM, which offers the highest noise immunity, and Low consumption mode, which can be adopted when very low energy consumption is desired and data transmission is not involved. The second benefit is the embedded spread-spectrum dithering option, which can further reduce electromagnetic interference by cutting harmonic disturbances in the operating frequency range. This proven technology can reduce conducted emissions by up to 7-8dB/ $\mu$ V.

The following EMI/EMC graphs clearly show the impact on interference when the Frequency dithering option (known also as Spread Spectrum - SS) is enabled. The measurements provided demonstrate compliance with CISPR25 (red line for Peak Demodulator Receiver, and yellow for Average), while a Bead is used as an input filter (BLM18AG102SN1 - 1000 $\Omega$ /450mA)

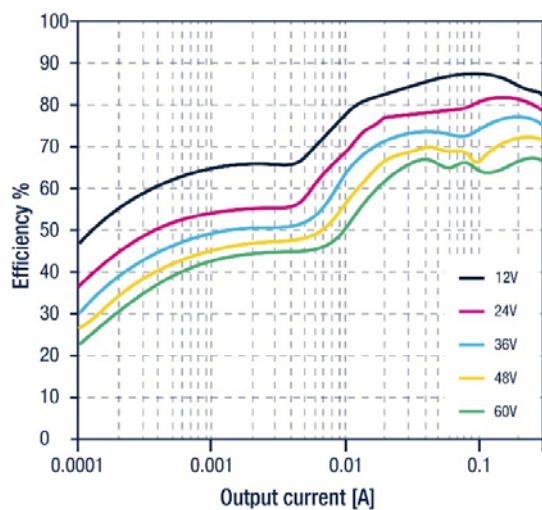


**Fig. 3.**  $V_{in} = 24V$   $V_{out} = 3.3V$ ,  $F_{sw} = 1$  MHz, SS = OFF

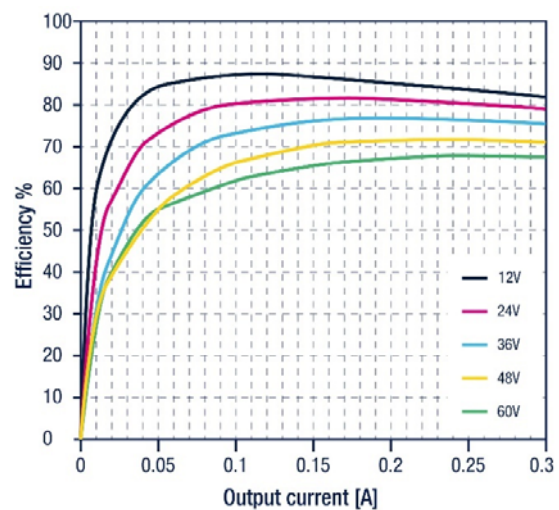
**Fig. 4.**  $V_{in} = 24V$   $V_{out} = 3.3V$ ,  $F_{sw} = 1$  MHz, SS = ON

The other major performance benefit is the ultra-low consumption capability. The Enable pin allows the L7983 to draw as little as  $2.3\mu A$  leakage when it is off, and not more than  $10\mu A$  when operational (L7983PU33R,  $V_{IN} > 24V$ , LCM).

What renders this device particularly suitable for IoT applications is the ability to maintain efficiency above 80% even at a few tens of milliampere loads (LCM – Low Consumption Mode), and over 90% when the application is drawing full power (LNM - Low Noise Mode).



**Fig. 5.** Efficiency vs load,  $V_{out} = 3.3V$ , LCM,  $F_{sw} = 1$  MHz



**Fig. 6.** Efficiency vs load,  $V_{out} = 3.3V$ , LNM,  $F_{sw} = 1$  MHz

Another significant feature is the way the device facilitates overall size reduction by virtue of its tiny package and high level of integration, which reduces the external component requirements and therefore allows very small solution footprints, as shown in the image below.

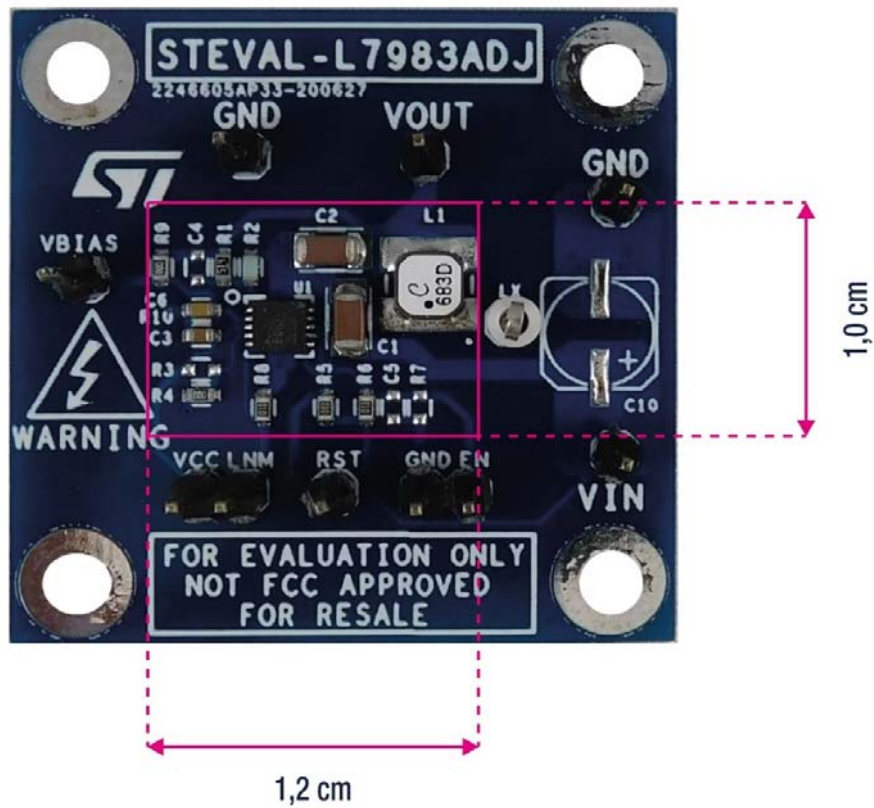


Fig. 7. L7983 Footprint

Additional features include support for power sequencing and synchronization with an external clock, and embedded safety and protections, including soft-start, overtemperature protection, current limiting with pulse-by-pulse sensing, overvoltage protection, and adjustable undervoltage lockout (UVLO), depending on the input voltage. Furthermore, integrated compensation circuitry helps simplify designs and lower bill-of-materials costs.

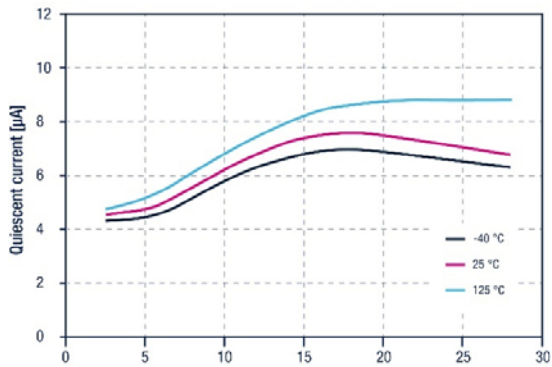
IoT applications may also require relevant current loads for different peripherals such as HMI, audio amplifiers, image sensors, connectivity, and other intelligent ICs included to enhance the IoT functionality.

While the abovementioned regulation is most advisable loads upwards of several tens of mA, very light loads in the order of a few mA may just as well be managed via linear regulation. To accommodate this, ST can complete your solution with an ultra-low quiescent POL.

The [ST730/ST732](#) family of MPN lines allows you to choose the right device from a variety of adjustable or fixed output voltage solutions with or without enable pins.

In the SOT32-5L package, this 5µA quiescent current device can easily regulate 12 or 24V bus rails down to any light peripherals above 1.8V, ensuring the best energy efficiency even in always-on applications.

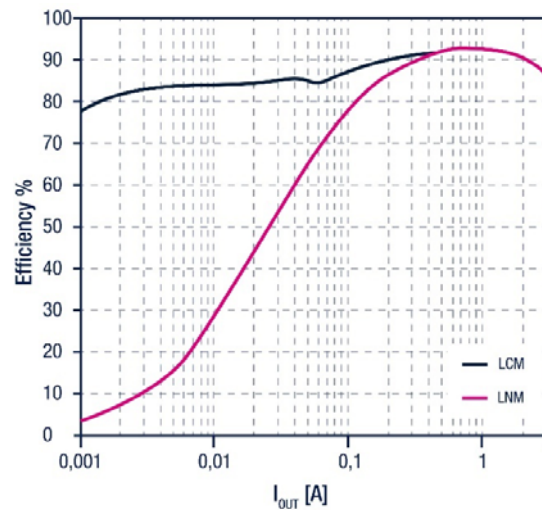
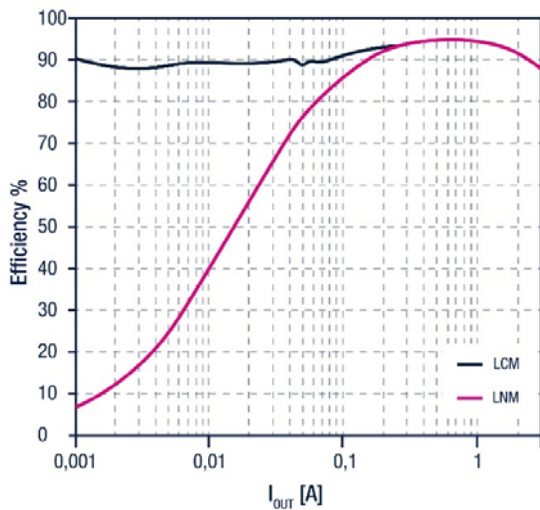




**Fig. 8.** ST73x family quiescent current vs V<sub>IN</sub> (@I<sub>OUT</sub>=0mA)

For larger current loads, another new Buck regulator is available with same IP and design philosophy as the L7983.

**L6983** 38V/3A synchronous DC/DC converters maintain ultra-high efficiency across all loads, with an almost 95% peak value, and integrate synchronous MOSFET on-chip to save external components and simplify designs. The figures below show the efficiency at V<sub>IN</sub>=12/24V and V<sub>OUT</sub>=5V in both Low Consumption Mode and Low Noise Mode.



**Fig. 9.** V<sub>IN</sub> = 12V; V<sub>OUT</sub> 5V, LCM-LNM, F<sub>sw</sub> = 400 kHz

**Fig. 10.** V<sub>IN</sub> = 24V; V<sub>OUT</sub> 5V, LCM-LNM, F<sub>sw</sub> = 400 kHz

With a wide input-voltage range from 3.5V to 38V, the L6983 represents another efficient and flexible solution for 12V and 24V industrial bus-powered systems, battery-powered equipment, and decentralized intelligent nodes such as smart-building controllers.

Low quiescent and low noise considerations are also inherent features, meaning the 17µA quiescent current of the L6983 is particularly useful for always-on devices tasked with sensing strategic application environment conditions.

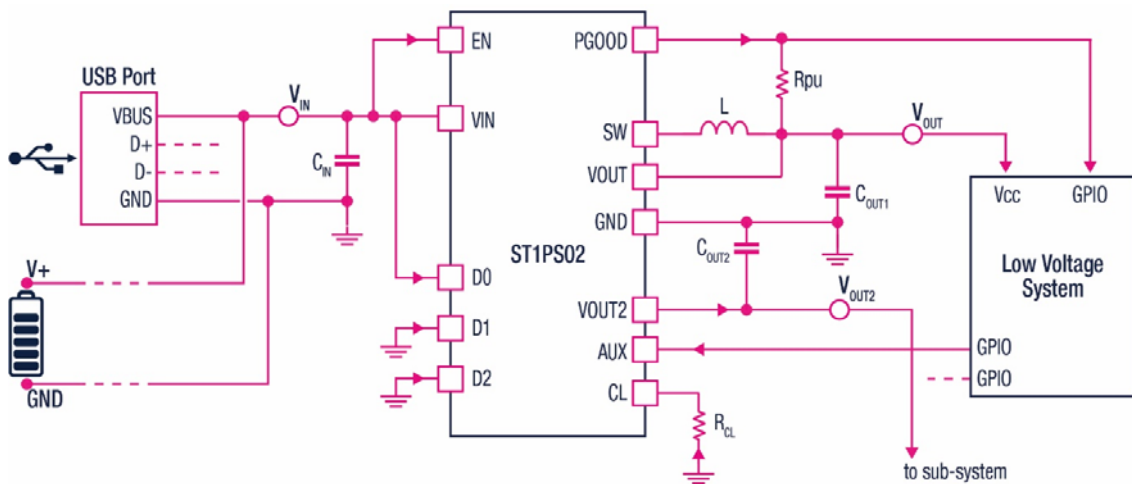
In order to achieve the highest possible compactness, the low-noise and low consumption variants of the device are fixed (L6983C and L6983N, respectively), with the L6983C device implementing pulse-skipping mode when the load current is below 0.6A.

Finally, system designers may need to implement post regulation to refine the specific power tree requirements for their applications.

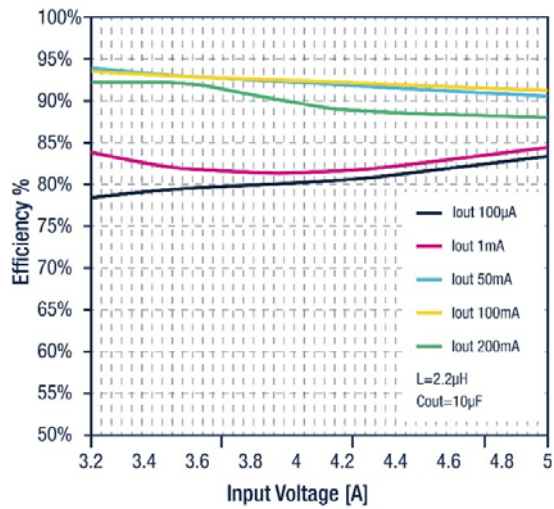
As already mentioned, it is advisable to post-regulate via a linear regulator in RF sensitive environments in order to suppress as much noise as possible for peripherals that require such clean signals, and the LDLN series is the best-in-class LDO for this purpose. The sizes are scaled to allow selection of the best fit for specific current loads. The 250mA [LDLN025](#) is the most popular option because it is able to meet typical system power demands with just 12 $\mu$ A quiescence and 6.5 $\mu$ Vrms noise.

When linear regulation is not sufficient and switching benefits are still required, we recommend the ST DCDC nano quiescent series. The [ST1PS01/02](#) is supplied in a range of packages for many application requirements and can provide regulation up to 400mA with on-the-fly  $V_{OUT}$  selection using external signals to meet specific power demands in different usage conditions. This device is used to very good effect in many ST battery-powered reference designs such as the [STEVAL-STWINKT1B](#) SensorTile Wireless Industrial Node (block diagram in [Fig.1](#)), with more designs under development.

This DC/DC converter features an ultra-low 500nA leakage current in no-load condition, contributing to a dramatic reduction in system stand-by consumption. With immediate wake-up, the converter can achieve 95% efficiency in certain conditions, as shown by the graph in [Fig.12](#). The ST1PS02 also embeds an auxiliary switch to facilitate the integration of a secondary peripheral supply.



**Fig. 11.** ST1PS02 application design



**Fig. 12.** Efficiency vs  $V_{IN}$ ,  $V_{OUT} = 3.3V$

ST is constantly researching, designing and releasing new power management solutions that help customers reduce development effort and achieve maximum performance and efficiency. For any design challenges you may be facing, do not hesitate to reach out to your regional ST contact for information and support.



life.augmented



DC+



LDO

[www.st.com/powermanagement](http://www.st.com/powermanagement)

[www.st.com/dcdc](http://www.st.com/dcdc)

[www.st.com/lido](http://www.st.com/lido)

## EBV European Headquarters

EBV Elektronik GmbH & Co. KG | DE-85586 Poing | Im Technologiepark 2-8 | Phone: +49 8121 774 0

## EBV Regional Offices | Status February 2021

### AUSTRIA

1120 Wien  
Grünbergstraße 15/1, 4. Stock  
Phone: +43 1 89152 0  
Fax: +43 1 89152 30

### BELGIUM

1831 Diegem  
De Kleetlaan 3  
Phone: +32 2 716001 0  
Fax: +32 2 72081 52

### BULGARIA

1505 Sofia  
48 Sitnyakovo Blvd., Serdika  
offices, 10th floor, Unit 1006  
Phone: +359 2 9264 337  
Fax: +359 2 9264 133

### CZECH REPUBLIC

18600 Prague  
Amazon Court, Karolinska 661/4  
Phone: +420 2 34091 011  
Fax: +420 2 34091 010

### DENMARK

8230 Åbyhøj  
Ved Lunden 10-12, 1. sal  
Phone: +45 8 6250 466  
Fax: +45 8 6250 660

### ESTONIA

80042 Pärnu  
Suur-Jõe 63  
Phone: +372 5 8864 446

### FINLAND

02180 Espoo  
Klovinpellontie 1-3  
Phone: +358 9 2705279 0  
Fax: +358 9 27095498

### FRANCE

91300 Massy Cedex (Paris)  
Le Copernic bât B  
12 rue Jean Bart  
Phone: +33 1 644729 29

35510 Cesson Sévigné (Rennes)  
35, av. des Peupliers  
Phone: +33 2 998300 51  
Fax: +33 2 998300 60

67400 Illkirch Graffenstaden  
35 Rue Gruninger  
Phone: +33 3 904005 92  
Fax: +33 3 886511 25

31500 Toulouse  
8 chemin de la terrasse  
Parc de la plaine  
Phone: +33 5 610084 61  
Fax: +33 5 610084 74

69693 Venissieux (Lyon)  
Parc Club du Moulin à Vent  
33, Av. du Dr. Georges Lévy  
Phone: +33 4 727802 78  
Fax: +33 4 780080 81

### GERMANY

85609 Aschheim-Dornach  
Einsteinting 1  
Phone: +49 89 388 882 0  
Fax: +49 89 388 882 020

10553 Berlin  
Kaiserin-Augusta-Allee 14  
Phone: +49 30 747005 0  
Fax: +49 30 747005 55

30938 Burgwedel  
Burgdorfer Straße 2  
Phone: +49 5139 8087 0  
Fax: +49 5139 8087 70

59439 Holzwickede  
Wilhelmstraße 1  
Phone: +49 2301 94390 0  
Fax: +49 2301 94390 30

41564 Kaarst  
An der Gumpgesbrücke 7  
Phone: +49 2131 9677 0  
Fax: +49 2131 9677 30

71229 Leonberg  
Neue Ramtelstraße 4  
Phone: +49 7152 3009 0  
Fax: +49 7152 759 58

90471 Nürnberg  
Lina-Ammon-Straße 19B  
Phone: +49 911 817669 0  
Fax: +49 911 817669 20

04435 Schkeuditz  
Frankfurter Straße 2  
Phone: +49 34204 4511 0  
Fax: +49 34204 4511 99

78048 VS-Villingen  
Marie-Curie-Straße 14  
Phone: +49 7721 99857 0  
Fax: +49 7721 99857 70

65205 Wiesbaden  
Borsigstraße 36  
Phone: +49 6122 8088 0  
Fax: +49 6122 8088 99

### HUNGARY

1117 Budapest  
Budafoki út 91-93, West Irodaház  
Phone: +36 1 43672 29  
Fax: +36 1 43672 20

### ISRAEL

4581500 Bnei Dror  
Tirosh 1  
Phone: +972 9 77802 60  
Fax: +972 3 76011 15

### ITALY

20095 Cusano Milanino (MI)  
Via Alessandro Manzoni, 44  
Phone: +39 02 660962 90  
Fax: +39 02 660170 20

50019 Sesto Fiorentino (FI)  
Via Lucchese, 84/B  
Phone: +39 05 543693 07  
Fax: +39 05 542652 40

41126 Modena (MO)  
Via Scaglia Est, 31  
Phone: +39 059 292 4211  
Fax: +39 059 292 9486

00139 Roma (RM)  
Via de Settebagni, 390  
Phone: +39 06 4063 665/789  
Fax: +39 06 4063 777

35030 Sarmeola di Rubano (PD)  
Piazza Adelaide Lonigo, 8/11  
Phone: +39 049 89747 01  
Fax: +39 049 89747 26

10144 Torino (TO)  
Via Treviso, 16  
Phone: +39 011 26256 90  
Fax: +39 011 26256 91

### IRELAND

Fitzwilliam Hall  
Fitzwilliam Place  
Dublin 2  
D02 T292  
Phone: +353 1 4097 802  
Fax: +353 1 4568 544

### NETHERLANDS

Zonnebaan 9  
3542 EA Utrecht  
Phone: +31 346 5830 10  
Fax: +31 346 5830 25

### NORWAY

3440 Røyken  
Kleiverveien 35  
Phone: +47 22 67 17 80  
Fax: +47 22 67 17 89

### POLAND

80-838 Gdansk  
Targ Rybny 11/12  
Phone: +48 58 30781 00

P02-676 Warszawa  
Postepu 14  
Phone: +48 22 209 88 05

50-062 Wrocław  
Pl. Solny 16  
Phone: +48 71 34229 44  
Fax: +48 71 34229 10

### PORTUGAL

4400-676 Vila Nova de Gaia Unipessoal  
LDA / Edifício Tower Plaza  
Rotunda Eng. Edgar Cardoso, 23 - 14ºG  
Phone: +351 22 092026 0  
Fax: +351 22 092026 1

### ROMANIA

020334 Bucharest  
4C Gara Herastrau Street  
Building B, 2nd Floor - 2nd District  
Phone: +40 21 52816 12  
Fax: +40 21 52816 01

### RUSSIA

620028 Ekaterinburg  
Tatischeva Street 49A  
Phone: +7 343 31140 4  
Fax: +7 343 31140 46

127486 Moscow  
Korovinskoye Shosse 10,  
Build 2, Off. 28  
Phone: +7 495 730317 0  
Fax: +7 495 730317 1

197374 St. Petersburg  
Atlantic City, Savushkina str 126,  
lit B, premises 59-H, office 17-2  
Phone: +7 812 635706 3  
Fax: +7 812 635706 4

### SERBIA

11070 Novi Beograd  
Milentija Popovica 5B  
Phone: +381 11 40499 01  
Fax: +381 11 40499 00

### SLOVAKIA

82109 Bratislava  
Turcianska 2 Green Point Offices  
Phone: +421 2 321114 1  
Fax: +421 2 321114 0

### SLOVENIA

1000 Ljubljana  
Dunajska cesta 167  
Phone: +386 1 5609 778  
Fax: +386 1 5609 877

### SOUTH AFRICA

7700 Rondebosch, Cape Town  
Belmont Office Park, Belmont Road  
1st Floor, Unit 0030  
Phone: +27 21 402194 0  
Fax: +27 21 4196256

3629 Westville  
Forest Square, 11 Derby Place  
Suite 4, Bauhinia Building  
Phone: +27 31 27926 00  
Fax: +27 31 27926 24

2128 Rivonia, Sandton  
Johannesburg  
33 Riley Road  
Pinewood Office Park  
Building 13, Ground Floor  
Phone: +27 11 23619 00  
Fax: +27 11 23619 13

### SPAIN

08014 Barcelona  
c/ Tarragona 149 - 157 Planta 19 1º  
Phone: +34 93 47332 00  
Fax: +34 93 47363 89

39005 Santander (Cantabria)  
Racing nº 5 bajo  
Phone: +34 94 22367 55  
Phone: +34 94 23745 81

28760 Tres Cantos (Madrid)  
c/ Ronda de Poniente 14 - 2ª planta  
Phone: +34 91 80432 56  
Fax: +34 91 80441 03

### SWEDEN

16440 Kista  
Isafjordsgatan 32B, Floor 6  
Phone: +46 859 47023 0  
Fax: +46 859 47023 1

### SWITZERLAND

8953 Dietikon  
Bernstrasse 394  
Phone: +41 44 74561 61  
Fax: +41 44 74561 00

### TURKEY

06520 Ankara  
Armada Is Merkezi  
Eskisehir Yolu No: 6, Kat: 14  
Ofis No: 1406, Sogutozu  
Phone: +90 312 2956 361  
Fax: +90 216 528831 1

34774 Ümraniye / Istanbul  
Tatlısu Mahallesi Pakdil Sokak 7  
Phone: +90 216 528831 0  
Fax: +90 216 528831 1

35580 Izmir  
Folkart Towers  
Manas Blv. No 39 B Blok  
Kat: 31 Ofis: 3121  
Phone: +90 232 390 9196  
Fax: +90 216 528831 1

### UKRAINE

03040 Kiev  
Vasilovskaya str. 14  
off. 422-423  
Phone: +380 44 496222 6  
Fax: +380 44 496222 7

### UNITED KINGDOM

Maidenhead (South)  
Berkshire, SL6 7RJ  
2, The Switchback  
Gardner Road  
Phone: +44 16 28778556  
Fax: +44 16 28783811

Manchester (North)  
M22 5WB  
Manchester International Office Centre  
Suite 3E (MIOC) Styal Road  
Phone: +44 16 149934 34  
Fax: +44 16 149934 74