

# ANALOG ICs AND DISCRETES

06.2018



HIGH-PERFORMANCE SOLUTIONS FOR  
PRECISION SIGNAL CHAIN DESIGN

# ANALOG & DISCRETES



## Complete Signal Chain Solutions

Renesas' broad precision analog portfolio provides a wide range of next-gen precision instrumentation, medical, communication and industrial process control applications where innovation, reliability and dependability is central to the analog designs.

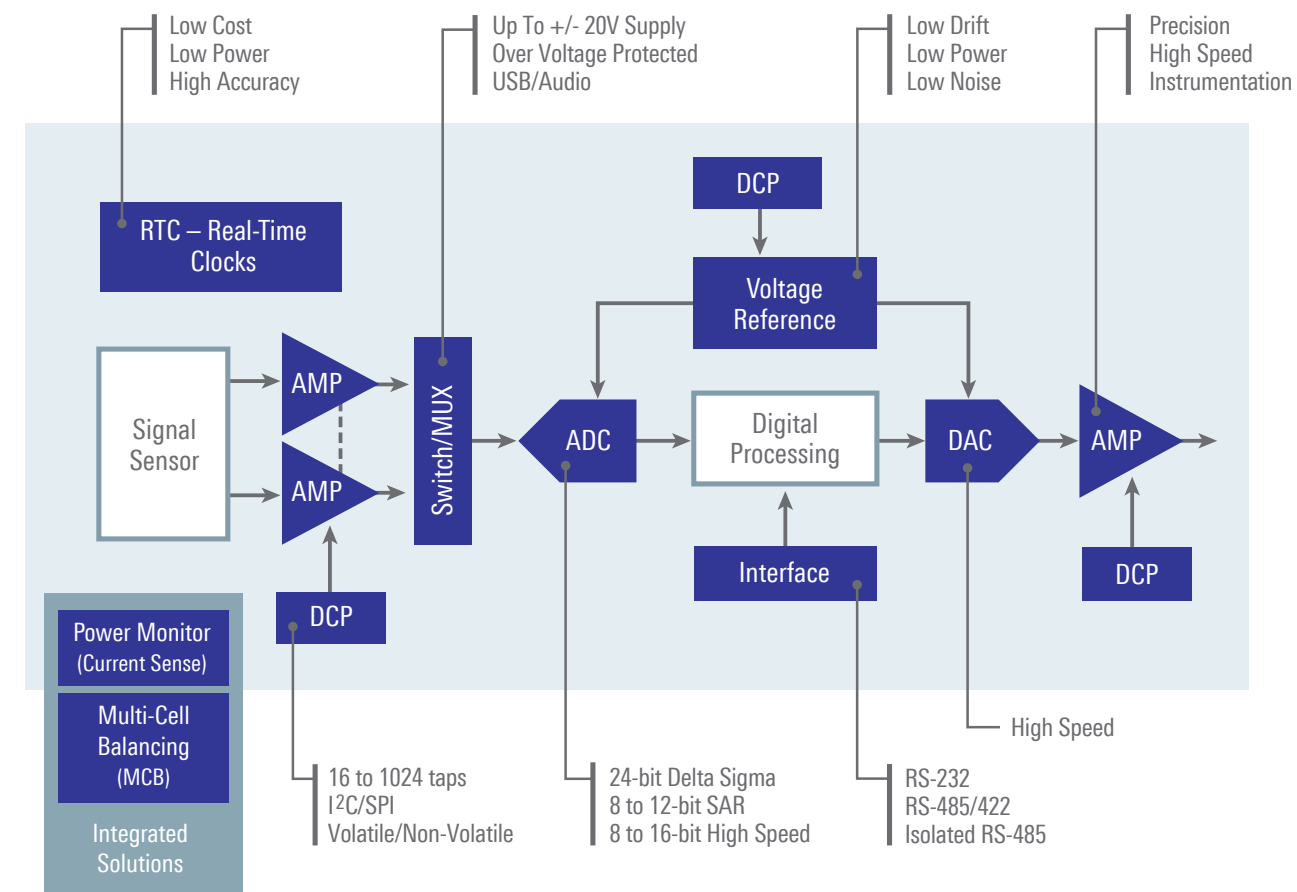

### CONTENTS

#### Analog

##### Integrated Analog Solutions

- Digital Power Monitors ..... 4
- Multi-cell Battery Management ..... 5

##### Amplifiers

- Precision Op Amps ..... 6
- Bipolar and CMOS  
Op Amps/Comparators ..... 8
- Current Sense Amplifiers ..... 10
- High Speed Op Amps ..... 12

##### Interface ..... 14

##### Data Converters

- High Speed ADC/DACs ..... 16
- Precision Data Converters ..... 17
- Voltage References ..... 18
- Digital Potentiometers ..... 19

##### Real-Time Clocks ..... 20

#### Discrete

- Photocouplers ..... 22
- Triacs/Thyristors ..... 24
- IGBTs ..... 26
- General Switching MOSFETs ..... 27
- Low Power SRAM Memory ..... 30

#### Resources ..... 32

Integrated Analog Solutions

# DIGITAL POWER MONITORS

## Highly Accurate Digital Current Sense and Voltage Monitors

The ISL28023/25 digital power monitor is a high-side and low-side digital current sense and voltage monitor with serial interface. The "digital power monitor", or DPM allows monitoring of power supplies, RF systems and other high voltage applications.



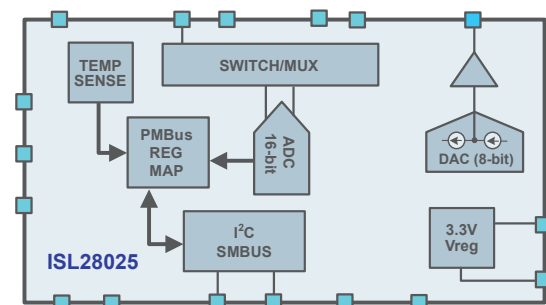

## Simple Integrated Solution with Serial I<sup>2</sup>C Interface with Alarms



Measures Voltage and Current (high-side & low-side, bi-directional)

- Input common mode up to 60V
- High accuracy – 0.05% error (16-bit ADC)
- User defined alerts – OV, UV, OC
- Additional features (margin DAC, voltage regulator, internal temp sensor, auxiliary channel)
- GUI software to configure

Precision Digital Power Monitors	Basic	Full Featured	Tiny Package
	 <b>ISL28022</b>	 <b>ISL28023</b>	 <b>ISL28025</b>
Input Range	0 to 60V	Opt 1: 0 to 60V Opt 2: 0 to 16V	Opt 1: 0 to 60V Opt 2: 0 to 16V
Primary Channel	Yes	Yes	Yes
LV Aux Channel	–	Yes	Voltage Only
Internal Temp Sensor	–	Yes	Yes
External Temp Sensor	–	Yes	–
HV Internal Regulator (3.3Vout)	–	Yes	Yes
Fast OC/OV/UV Alert Outputs	–	2	2
Margin DAC	–	Yes	–
Slave Addresses Available	16	55	55
User Select Conversion Mode/Sample Rate	Yes	Yes	Yes
User Select Fixed Period Averaging	–	Yes	Yes
Peak Min/Max Current Registers	–	Yes	Yes
I <sup>2</sup> C/SMBus	Yes	Yes	Yes
PMBus	–	Yes	Yes
1.2V I <sup>2</sup> C Level Translators	–	Yes	Yes
High Speed (3.4MHz) I <sup>2</sup> C Mode	Yes	Yes	Yes
External Clock Input	Yes	Yes	Yes
Power Shutdown Mode	Yes	Yes	Yes
Package	10 Ld MSOP, 16 Ld QFN	24 Ld QFN	16 Ld WLCSP

Integrated Analog Solutions

# MULTI-CELL BATTERY MANAGEMENT

## Protect, Monitor & Balance Rechargeable Battery Packs

Renesas battery management system (BMS) monitors battery life and prevents catastrophic conditions. The BMS circuitry can also extend the run-time and lifetime of a battery.

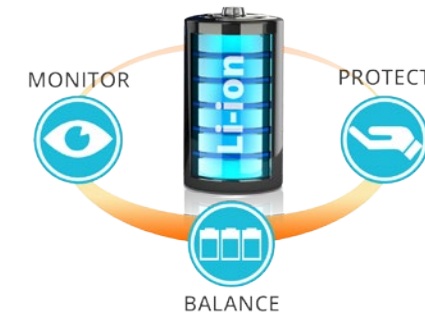

### Diagnostic and Protection

- Protects battery pack and IC
  - Auto-scan of cell voltages and temperature
- Built-in fault detection
- Provides diagnostic information
- Robust hot-plug performance

### Monitors

- Monitors pack current and direction

### Cell Balancing

- Built-in cell balance FET drivers
- Automatic cell balance turn off on IC over-temperature

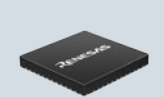
Multi-Cell Battery Management	Multi-Cell Battery Management and Balancing	3 to 8 Cell Li-Ion Battery Pack Manager	4 to 6 Cell Li-Ion Battery Management Analog Front End
		 <b>ISL94212</b>	 <b>ISL94202/03</b>
# Series Cells	6 to 12 Cells	3 to 8 Cells	4 to 6 Cells
Communication Interface	SPI	I <sup>2</sup> C	I <sup>2</sup> C
Cell Balancing	External (Built-in FET Drivers)	External (Built-in FET Drivers)	Internal
Pack Voltage	Up to 63V per Device	6V to 36V	8V to 27V
Absolute Cell Voltage Measurement Accuracy	10mV max (0°C to 50°C)	15mV max (0°C to 60°C)	30mV max (-40°C to 85°C)
Integrated Charge/Discharge FET Drive	No	Yes	Yes
Integrated Current Sense/Detection	No	Yes (High-Side Measurement)	Yes (Low-Side Detection)
Integrated Temp Sense	Yes	Yes	Yes
Supply Current	5mA Max	370µA Max	510µA Max
Shutdown Supply Current	1.2µA Typ	1µA Max	1µA Typ
Integrated Voltage Regulator Output	3.3V	2.5V	3.3V
Integrated Voltage Reference Output	2.5V	2.5V	3V
Temperature Range	-40°C to +85°C	-40°C to +85°C	-40°C to +85°C
Special Features	– Daisy chain up to 14 devices (168 cells) – Robust hot-plug performance – Provides diagnostic information – Fast scan rate of 20µs/cell	– Complete stand-alone operation or with external µC – Provides diagnostic information – Robust hot-plug performance – Fast scan rate of 10µs/Cell	– Analog voltage output – Robust hot-plug performance – Provides diagnostic information
Package	64 Ld TQFP (12x12mm)	48 Ld TQFN (6x6mm)	32 Ld QFN (5x5mm)

Amplifiers

# PRECISION OP AMPS

$V_{OS} < 1mV$  Operational Amplifiers



## Unmatched Precision When Accuracy Matters

### Zero Drift Amplifiers (Low Voltage Precision Op Amps)

ISL28x33, ISL28x34

Chopper-stabilized amplifiers (Zero Drift Amplifiers) offer one of the best solutions, for the lowest offset voltage and drift. These amplifiers achieve high DC precision through a continuously running calibration mechanism that is implemented on-chip.

### Key Features

- Low drift/reduced offset voltage over temperature (typically  $< 0.5nV/^\circ C$ ) [figure 1]
- Low drift/reduced offset voltage over time [figure 2]
- Low offset voltage/reduced offset voltage (typically  $< 1\mu V$ ) [figure 3]
- Low offset voltage over the common mode range and power supply (CMRR & PSRR typically  $> 125dB$ ) [figure 4]
- Eliminates or no 1/f noise [figure 5]
- Very high open loop gain

### Applications

- Bi-directional current sense
- Temperature measurement
- Medical equipment
- Electronic weigh scales

### Low Drift Over Temperature

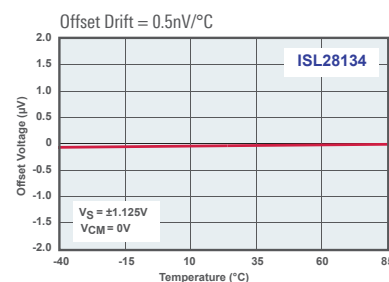

Figure 1.  $V_{OS}$  vs Temperature

### Low Noise

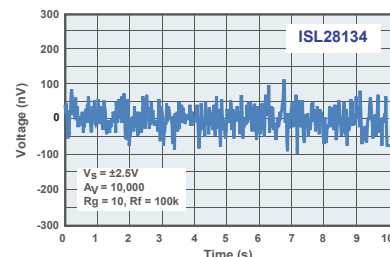

Figure 2. Input Noise Voltage 0.1Hz to 10Hz

### Low Offset Voltage

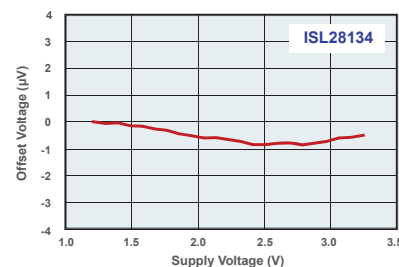

Figure 3.  $V_{OS}$  vs Supply Voltage

### High CMRR/PSRR

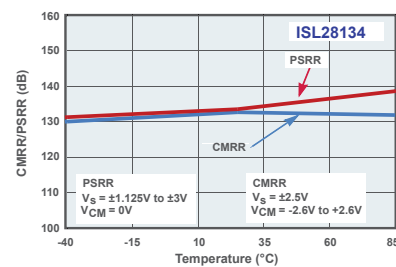

Figure 4. CMRR vs Temperature

### No 1/f Noise

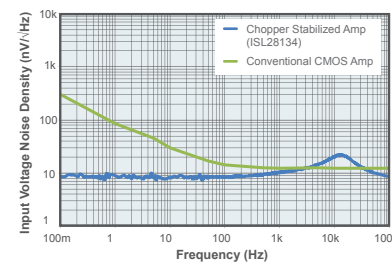

Figure 5. 5V CMOS ISL28134 vs CMOS Amp Noise Voltage Density Comparison

## Precision Op Amps

							High Precision					Low Power	Low Noise		
Type				Part Number			Supply Voltage (V)		Offset Voltage	Offset Voltage	TCVos	Input Bias Current	Supply Current	Slew Rate	Voltage Noise
Ultra Precision	Low Noise	Low Power	Low Input Bias Current	Single	Dual	Quad	Min	Max	Max @ 25°C	Max Temp	Max	Max @ 25°C	Max Temp	V/μs	@ 1kHz
Low Voltage															
• (Zero-drift)	•		•	ISL28134	–	–	2.25	6	2.5μV	3.4μV	15nV/°C	300pA	1.05mA	1.5	10nV/√Hz
• (Zero-drift)		•	•	ISL28133*	ISL28233	ISL28433	1.8	5.5	6μV	11μV	50nV/°C	180pA	35μA	0.2	65nV/√Hz
•		•	•	ISL28130	ISL28230	ISL28430	1.8	5.5	40μV	55μV	150nV/°C	250pA	35μA	0.2	65nV/√Hz
				ISL28136	ISL28236	–	2.4	5.5	150μV	270μV	–	35nA	1.4mA	1.9	15nV/√Hz
		•	•	ISL28158	–	–	2.4	5.5	300μV	650μV	–	30pA	55μA	0.1	64nV/√Hz
	•			ISL28191	ISL28291	–	3	5.5	630μV	840μV	–	6μA	3.9mA	17	1.7nV/√Hz
	• (Lowest Noise)			–	ISL28290	–	3	5.5	700μV	900μV	–	16μA	13mA	50	1nV/√Hz
			•	–	ISL28288	ISL28488	2.4	5.5	1.5mV	2mV	–	30pA	175μA	0.14	48nV/√Hz
			•	ISL28148	ISL28248	–	2.4	5.5	1.8mV	2mV	–	30pA	1.4mA	4	28nV/√Hz
		• (Nano-Power)	•	ISL28194	–	–	1.8	5.5	2mV	2.5mV	–	80pA	500nA	0.0012	265nV/√Hz*
			•	ISL28113	ISL28213	ISL28413	1.8	5.5	5mV	6mV	10μV/°C	20pA	170μA	1	55nV/√Hz
			•	ISL28114	ISL28214	ISL28414	1.8	5.5	5mV	6mV	10μV/°C	20pA	400μA	2.5	40nV/√Hz
High Voltage (PR40)															
•	•			ISL28117B	ISL28217B	ISL28417B	4.5	40	50μV	110μV	0.6μV/°C	1nA	680μA	0.5	8nV/√Hz
•	•			ISL28127	ISL28227	–	4.5	40	70μV	120μV	0.5μV/°C	10nA	3.7mA	3.6	2.5nV/√Hz
•			•	ISL28107	ISL28207	ISL28407	4.5	40	75μV	140μV	0.65μV/°C	300pA	350μA	0.32	13nV/√Hz
	•			ISL28118	ISL28218	–	3	40	150μV	270μV	1.2μV/°C	575nA	1.4mA	1.2	5.6nV/√Hz
				ISL28108	ISL28208	ISL28408	3	40	150μV	330μV	1.1μV/°C	43nA	1.4mA	0.45	15.8nV/√Hz
	•		• (JFET Input)	ISL28110	ISL28210	–	9	40	300μV	1.3mV	10μV/°C	2pA	3.8mA	20	6nV/√Hz
	•			ISL28177	–	–	4.5	40	150μV	250μV	1.4μV/°C	1nA	–	0.2	9.5nV/√Hz
	•			–	ISL28325	ISL28345	5	40	1mV	–	15μV/°C	5nA	–	0.4	9nV/√Hz

\* Check Data Sheet Conditions

Amplifiers

# BIPOLAR & CMOS OP AMPs/COMPARATORS

## Op Amps to Solve Your Design Challenges

### Design Challenge #1

#### Energy Saving Product



- High demand of developing energy-saving products
- Adoption of energy-saving sensors such as current sensor, pressure sensor, gas sensor

#### Renesas Op Amp Solution

Renesas provides full range of input & output CMOS high precision amplifier products to meet the industry-demanding requirements of accurate sensing.

##### CMOS Operational Amplifiers

Type	V <sub>DD</sub> (V)	V <sub>IO</sub> max. (mV)	SR typ. (V/μs)	I <sub>S</sub> typ. (mA)	Rail-to-Rail	Dual	Quad
Low Power	1.8 to 5.5	±5mV	0.35V/μs	1mA	Input & Output	READ2351JSP (Industrial)	Coming soon
High Slew Rate	2.5 to 5.5	±5mV	8V/μs	10mA	Input & Output	READ2302GSP (General purpose) READ2352JSP (Industrial)	Coming soon

### Design Challenge #2

#### Short Development Time



#### Renesas Op Amp Solution

Renesas provides total kit solutions for MCU and op amp products. Simplify the design process and reduce development turn around time by utilizing the provided circuit diagrams and recommended parts.

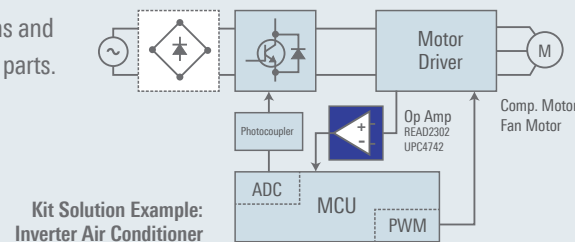

### Design Challenge #3

#### BOM Size

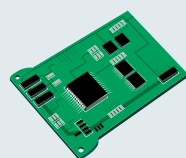

- Complex ecosystem on battery-powered small applications

#### Renesas Op Amp Solution

Renesas is expanding to include small MSOP package option to achieve mount area reduction.

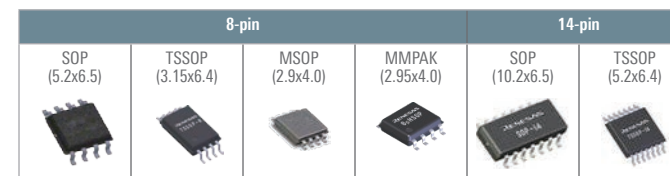
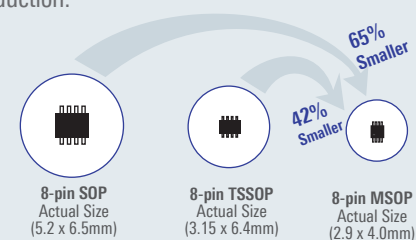

### CMOS Operational Amplifiers

Type	Rail-to-Rail	Part Number	Power Supply Voltage (V)	V <sub>IO</sub> (max) (mV)	I <sub>DD</sub> (typ) (μA/ch)	TPLH/HL (μs)	Channels	Package
Low power	Input/output	READ2351J (Industrial)	1.8 to 5.5	±5	60	0.5	2	8-pin TSSOP
High slew rate	Input/output	READ2302G (General purpose)	2.5 to 5.5	±5	700	8	2	8-pin TSSOP
	Input/output	READ2352J (Industrial)	2.5 to 5.5	±5	700	8	2	8-pin TSSOP

### Bipolar Operational Amplifiers

Type	Part Number		Power Supply Voltage (V)	V <sub>IO</sub> (max) (mV)	I <sub>CC</sub> (max) (mA)	SR (typ) (V/μs)	Channels	Package
	Industrial	General Purpose						
Single power supply	uPC451	—	3 to 30	±7	2	0.3	4	14-pin SOP/TSSOP
	uPC452	uPC3403	3 to 32	±7	7	0.8	4	14-pin SOP
	uPC842	uPC4742	3 to 32	±5	4.5	7	2	8-pin SOP/TSSOP
	uPC844	uPC4744	3 to 32	±5	9	7	4	14-pin SOP/TSSOP
	uPC1251	—	3 to 30	±7	1.2	0.3	2	8-pin SOP/TSSOP
Low noise	uPC258	uPC4558	±4 to ±16	±6	5.7	1	2	8-pin SOP
	uPC259	uPC4560	±4 to ±16	±6	5.7	2.8	2	8-pin SOP
	uPC458	uPC4741	±4 to ±16	±5	7	1	4	14-pin SOP
	—	uPC4570	±4 to ±16	±5	8	7	2	8-pin SOP/TSSOP
	—	uPC4572	±2 to ±7	±5	7	6	2	8-pin SOP
J-FET	—	uPC4574	±4 to ±16	±5	12	6	4	8-pin SOP/TSSOP
	uPC811	—	±5 to ±16	±2.5	3.4	15	1	8-pin SOP/TSSOP
	uPC812	uPC4092	±5 to ±16	±3	6.8	15	2	8-pin SOP/TSSOP
	uPC813	—	±5 to ±16	±2.5	3.5	25	1	8-pin SOP/TSSOP
	uPC814	uPC4094	±5 to ±16	±3	6.8	25	2	8-pin SOP/TSSOP
	uPC822	uPC4072	±5 to ±16	±10	5	13	2	8-pin SOP/TSSOP
	uPC824	uPC4074	±5 to ±16	±10	10	13	4	14-pin SOP/TSSOP
	uPC832	uPC4062	±2 to ±16	±10	0.5	3	2	8-pin SOP/TSSOP
	uPC834	uPC4064	±2 to ±16	±10	1	3	4	14-pin SOP/TSSOP
	uPC835	—	±5 to ±16	±3	2.2	5.5	2	8-pin TSSOP
Low power	uPC802	—	±1 to ±16	±6	≤0.1	≤1.0	1	8-pin SOP
General	uPC251	uPC1458	±7.5 to ±16	±6	5.6	0.5	1	8-pin SOP

### Bipolar Comparators

Type	Part Number		Power Supply Voltage (V)	V <sub>IO</sub> (max) (mV)	I <sub>CC</sub> (max) (mA)	Tr/Tf (typ) (μs)	Channels	Package
	Industrial	General Purpose						
General	uPC177	—	2 to 32	±5	2	1.3	4	14-pin SOP/TSSOP
	uPC271	—	5 to 32	±7.5	7.5	0.2	1	8-pin SOP
	uPC272	uPC319	5 to 16	±8	12.5	0.08	2	14-pin SOP
	uPC277	—	2 to 32	±5	1	1.3	2	8-pin SOP/TSSOP

\* Industrial: Products with extended temperature tolerances (125°C).

Amplifiers

# CURRENT SENSE AMPLIFIERS

## Simplify the Design of Complex Current Monitoring Circuits

Current sense amplifiers (also called current shunt amplifiers) are special purpose operational amplifiers (op amps) that output a voltage proportional to the current flowing in a power rail. They utilize a "sense resistor" to convert the load current in the power rail to a small voltage, which is then amplified by the current sense amplifier. Renesas offers both discrete solution and integrated solution.

Discrete Solution

### Precision Op Amps For Current Sensing

A basic current sense amplifier is set up as a differential amplifier. The amp will reject the common mode voltage across V1 and V2, amplifying only the difference across the sense resistor (Eq. 1). Using Ohm's Law, substitute the delta V with the load current times the series resistance in Eq. 2, and solve for the load current (Eq. 3).

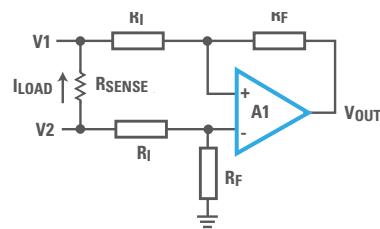

- A1 configured as differential amplifier
- Voltage across sense resistor amplified by A1
- Gain = R<sub>F</sub>/R<sub>I</sub>
- Amplifier rejects V<sub>CM</sub> across V1 and V2

Eq. 1:  $V_{OUT} = (R_F/R_I) * [V2-V1]$

Eq. 2:  $V_{OUT} = (R_F/R_I) * [I_{LOAD} * R_{SENSE}]$

Eq. 3:  $I_{LOAD} = (R_I/R_F) * [V_{OUT} * R_{SENSE}]$

### Most Common Discrete Solutions

Type	Part Number	TCV <sub>OS</sub>	V <sub>OS</sub> Max @ 25°C	Notes
Low Noise	ISL28290	–	700µV	Low cost (low side)
Low Drift	ISL28x30	150nV/°C	40µV	Good – still low cost
Zero Drift	ISL28x33	75nV/°C	8µV	Great
Zero Drift	ISL28x34	15nV/°C	2.5µV	World Class
Standard CMOS	ISL28113/114	2000nV/°C	5mV	
BJT	ISL28136	400nV/°C	150µV	

Generic Solution vs. Renesas High Precision Solution

Low offset voltage op amp in the sensing circuit allows for a much lower sense resistor and less wasted power

### Example – 20mA resolution, 5A full current

Solution	V <sub>OS</sub>	R <sub>sense</sub>	R <sub>sense</sub> Power Loss	Renesas Benefits
Generic	500µV	25mΩ	625mW	–
ISL28x30	40µV	2mΩ	50mW	92% reduction in wasted power
ISL28x34	2.5µV	125µΩ	3mW	99.5% reduction in wasted power

### Micropower, Low Drift, RRIO Operational Amplifiers

#### ISL28x30

- Ideal for low power high side or low side current sense applications
- 40µV max offset voltage
- 1.8V to 5.5V supply voltage
- Low quiescent power consumption 20µA (typ)

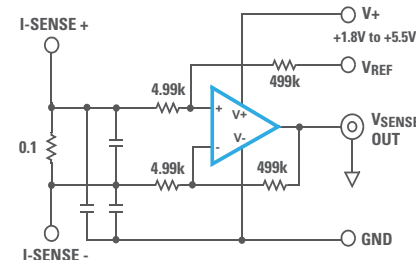

Bi-Directional Current Sense Amplifier

Integrated Solution

### The Simplest Type of Current Sense Amplifiers

The ISL28005 and ISL28006 are groundsensing current sense amplifiers that amplify milli-volt current signals developed across sub-1Ω sense resistors. The simplest type of current sense amplifiers use single stage op amp circuits that take their power from the same voltage source that generates the current to be measured.

### Micropower, Current Sense Amplifier with Voltage Output



#### ISL28005/6

- High or low side uni-direction current sense
- Low power consumption, 50µA (typ)
- TIA Architecture:
  - Input sense voltage converted to current
  - Current fed into 5V TIA for ADC drive
  - Constant 100kHz BW across gain
- Internal fixed gain for high accuracy and low TCVOs

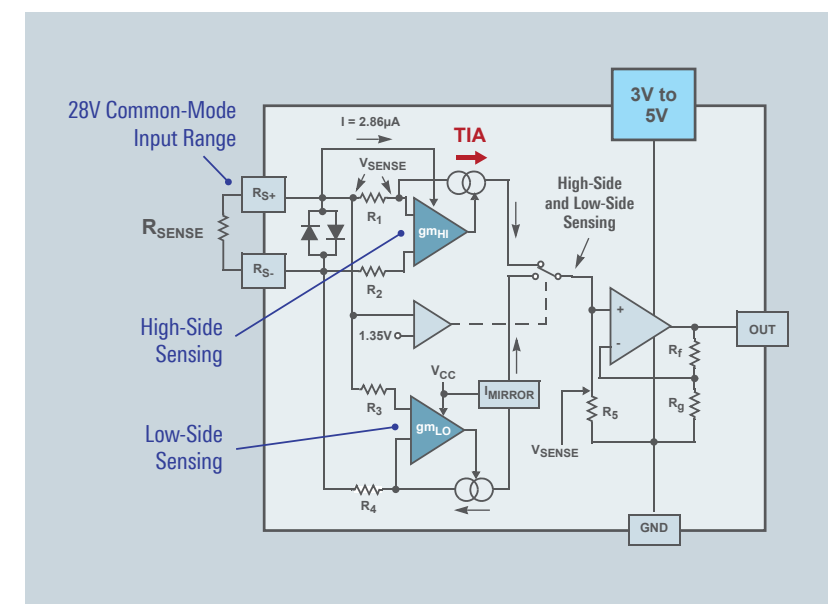

### Current Sense Amplifiers

Part Number	Supply Voltage Range	Input Common Mode Range	V <sub>OS</sub> max @ 25°C	V <sub>OS</sub> Max Temp	CMRR Min Temp	PSRR Min Temp	Gain Range	Gain Accuracy @ 25°C	Gain Accuracy Temp	I <sub>S</sub> Max @ 25°C	I <sub>S</sub> Max Temp	Package
	V	V	µV	µV	dB	dB	V/V	%	%	µA	µA	
ISL28005	2.7 to 28	0 to 28	500	500	105	90	20, 50, 100	2	3	59	59	5 Ld SOT-23
ISL28006	2.7 to 28	0 to 28	250	300	105	90	20, 50, 100, Adj (20-100)	0.7	1	62	62	5 Ld SOT-23, 6 Ld SOT-23

Amplifiers

# HIGH SPEED OP AMPS

Renesas' high speed op amp portfolio delivers best-in-class performance-to-power ratio with superior drive and slew rate performance at full bandwidths. This makes our operational amplifiers the perfect choice for video and high speed data transmission, A/D buffering, and high frequency filtering.

Unmatched SFDR-to-Power Ratio

ISL55210, ISL55211

The ISL55210 is a very wide band, voltage feedback, fully differential amplifier (FDA) intended for high dynamic range ADC input interface applications. This voltage feedback FDA design includes an independent output common mode voltage control.

Intended for very high dynamic range ADC interface applications at the lowest quiescent power (115mW), the ISL55210 offers a 4.0GHz Gain Bandwidth Product with a very low input noise of 0.85nV/√(Hz). In a balanced differential I/O configuration, with 2V<sub>P-P</sub> output into a 200Ω load configured for a gain of 15 dB, the IM3 terms are ≤ 100dBc through 110MHz. With a minimum operating gain of 2V/V (6dB), the ISL55210 supports a wide range of higher gains with minimal BW or SFDR degradation. Its ultra high differential slew rate of 5,600V/μs ensures clean large signal SFDR performance or a fast settling step response.

Key Features

- Gain bandwidth product: 4.0GHz
- Input voltage noise: 0.85nV/√(Hz)
- Differential slew rate: 5,600V/μs
- 2V<sub>P-P</sub>, 2-tone IM3 (200Ω) 100MHz: -109dBc
- Supply voltage range: 3.0V to 4.2V
- Quiescent power (3.3V supply): 115mW

Applications

- Low power, high dynamic range ADC interface
- Differential mixer output amplifier
- SAW filter pre/post driver
- Differential comms-DAC output driver

Fully Differential Amplifiers

Part Number	# of Channels	Topology	V <sub>S</sub> Min (V)	V <sub>S</sub> Max (V)	BW (MHz)	Gain (V/V)	Slew Rate (V/μsec)	Noise (nV/√Hz)	I <sub>S</sub> Max (mA)	I <sub>OUT</sub> (mA)	V <sub>OS</sub> Max (mV)	I <sub>B</sub> Max (μA)	RR In	RR Out	Headroom (V)	Shutdown
ISL55210	1	FDA	3	4.2	4000	RES	5600	0.85	38.5	30	1.6	140	No	No	1	Yes
ISL55211	1	FDA	3	4.2	1400	2, 4, 5	5600	0.85	38.5	30	1.6	140	No	No	1	Yes

World Best SFDR at Lowest Power

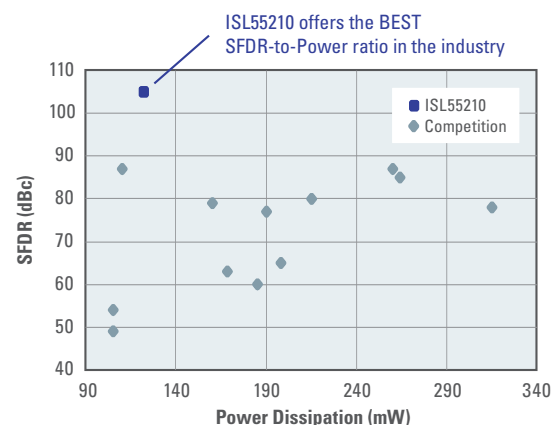

Ultra-low Distortion

Suitable for driving high speed ADCs in 1st and higher Nyquist zone applications

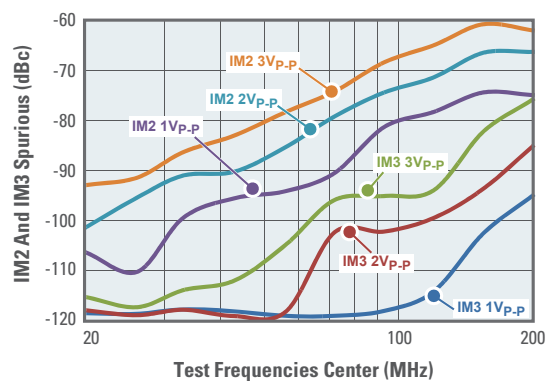

High Speed Op Amps

Part Number				Tech	Supply Voltage (V)		Min Gain	Bandwidth		Slew Rate (V/μs)	Voltage Noise @ 10kHz (nV/√Hz)	V <sub>OS</sub> Max @ 25°C (mV)	I <sub>S</sub> Max @ 25°C (mA)	Package							
Single	Dual	Triple	Quad		Min	Max		-3dB (MHz)	0.1dB (MHz)					Single	Dual	Triple	Quad				
Rail-to-Rail, Voltage Feedback Amplifiers																					
EL8101	EL8201	–	–	VFA	3	5/5.5	1	200	20	200	10	6	2.4	SOIC-8, SOT23-6, SOT23-5	MSOP-10, SOIC-8	–	–				
–	–	EL8302*	–	VFA	3	5.5	1	500	35/36	600	12	8/7	6.2	–	–	SOIC-16, QSOP-16	–				
Current Feedback Amplifiers																					
EL5160*	EL5161	–	–	CFA	5	10	1	200	10	1700/1300	4	5	0.85	SOIC-8, SOT23-6, SOT23-5	–	–	–				
EL5162*	EL5163	EL5262*	EL5263	EL5362*	EL5462	–	–	CFA	5	12	1	500	30	4000/2500	3	5	2	SOIC-8, SOT23-6, SC70-5, SOT23-5	MSOP-10, SOIC-8, MSOP-8	SOIC-16, QSOP-16	SOIC-14
EL5164*	EL5165	–	–	EL5364*	–	–	–	CFA	5	12	1	600	50	4700	2.1	5	4.2	SOIC-8, SOT23-6, SOT23-5	–	SOIC-16, QSOP-16	–
EL5166*	EL5167	–	–	–	–	–	–	CFA	5	12	1	1.4GHz	100	6000	1.7	5	9.3	SOIC-8, SOT23-6, SC70-5, SOT23-5	–	–	–
Slew Enhanced, Voltage Feedback Amplifiers																					
–	EL5202*	EL5203	–	–	VFA	3	10	1	400	–	2200	12	5	5.8	–	MSOP-10, SOIC-8, MSOP-8	–	–			
EL5104*	EL5105	EL5204*	EL5205	–	–	–	–	VFA	4	13	1	700	–	3000	10	10/18	11	SOIC-8, SOT23-6, SOT23-5	MSOP-10, SOIC-8, MSOP-8	–	–
High Voltage (Up to 30V)																					
ISL55001	ISL55002	–	ISL55004	VFA	5	30	1	200, 220	–	280/300	12	3	9.25	SOIC-8	SOIC-8	–	SOIC-14				
Fully Differential Amplifiers																					
ISL55210, ISL55211	–	–	–	FDA	3	4.2	RES/2, 4, 5	4GHz, 1.4GHz	–	5600	0.85	1.6	38.5	TQFN-16	–	–	–				
Fixed Gain Amplifiers																					
EL5106*	–	EL5306*	–	Gain	5	12	Fixed: +1, +2, -1	350	20	4500	2.8	10	1.82	SOT23-6	–	SOIC-16, QSOP-16	–				
–	–	EL5308*	–	Gain	5	12	Fixed: +1, +2, -1	450	40	4500	2	8	4.35	–	–	SOIC-16, QSOP-16	–				
–	–	ISL55033*	–	Gain	3	5.5	Fixed: +2, +4	400	40/60	2350/2500	35/50	9/10	8.5	–	–	TQFN-12	–				
Differential Line Drivers/Receivers																					
Drivers																					
EL5170*	–	–	–	Diff	4.75	11	2	100	12	1100	28	25	8.4	SOIC-8, MSOP-8	–	–	–				
EL5171	–	–	–	Diff	4.75	11	2	250	50	700/800	26	25	8.2	SOIC-8	–	–	–				
–	–	EL5373*	–	Diff	4.75	11	2	450	60	900/1100	25	30	14	–	–	QSOP-24	–				
EL5174	–	–	–	Diff	4.75	11	2	550	120	1100	21	25	14	SOIC-8	–	–	–				
EL5177*	–	–	–	Diff	4.75	11	ADJ	550	120	1100	21	25	14	MSOP-10	–	–	–				
–	–	EL5378*	–	Diff	4.75	11	2	700	45	850/1000	18	30	14	–	–	QSOP-28	–				
Receivers																					
EL5172*	–	–	–	Diff	4.75	11	ADJ	250	25	800	26	25	7	SOIC-8, MSOP-8	–	–	–				
EL5175*	–	EL5375*	–	Diff	4.75	11	ADJ	550	60	900	21	30/40	11	SOIC-8, MSOP-8	–	QSOP-24	–				
RF Gain Block/Amps																					
ISL55012, ISL55014, ISL55015	–	–	–	Single-ended	3	5.5	18, 17.2, 13.5	2.4, 2.75, 2.9GHz	–	–	–	–	63.5, 63	SC70-6	–	–	–				
ISL55016	–	–	–	Diff	4.5	5.5	17.1	2.2GHz	–	–	–	–	104	TDFN-6	–	–	–				

\* = With enable pin

# INTERFACE



## High Noise Immunity

Provides enhanced noise immunity and can drive longer cable lengths or more cable terminations.

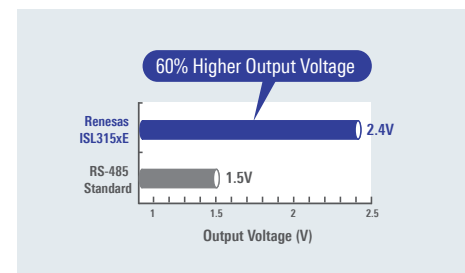

## Ultra Low Supply Current

ISL328xE and ISL329xE draw 30 times less power than competitive device.

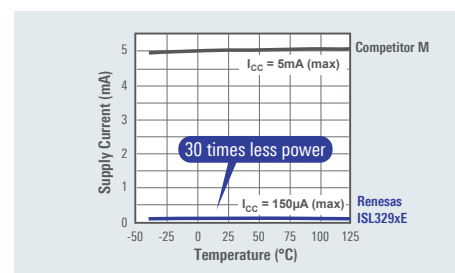

## Space-Saving Small Package

Reduced package size enables smaller more compact products.

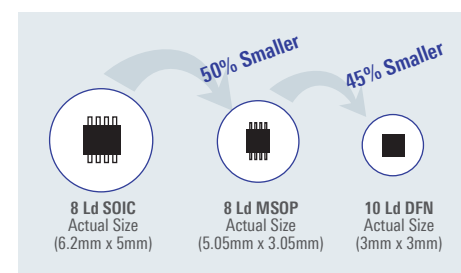

## Broad Portfolio to Fit Your Needs

RS-232	RS-232/RS-485	Isolated RS-485
<ul style="list-style-type: none"> <li>Single Transceiver (1 Tx/1 Rx)</li> <li>Dual Transceivers (2 Tx/2 Rx)</li> <li>Dual Transceivers + Extra Receiver (2 Tx/3 Rx)</li> <li>Triple Transceivers (3 Tx/3 Rx)</li> <li>8-Channel Transceivers (5 Tx/3 Rx)</li> <li>8-Channel Transceivers (3 Tx/5 Rx)</li> </ul>	<ul style="list-style-type: none"> <li>Standard 5V/3V RS-485 Transceivers</li> <li>Ultra-Low Power RS-485 Transceivers <b>ISL3260XE</b></li> <li>1.8V to 3.3V, Micro-Power ±15kV ESD</li> <li>Overvoltage Protected RS-485 Transceivers</li> <li>Dual Protocol Transceivers                             <ul style="list-style-type: none"> <li>– Programmable <b>ISL813xx, ISL413xx, ISL333x</b></li> <li>– Fixed <b>ISL333xxE</b> (See next page)</li> </ul> </li> </ul>	<ul style="list-style-type: none"> <li>40Mbps, Ultra-low EMI Isolated RS-485 Transceiver <b>ISL32740E/41E</b></li> <li>Industry's Smallest Package Isolated RS-485 Transceiver <b>ISL32704E</b> (See next page)</li> </ul>

## Dual Protocol Transceivers

Two-Port, Dual Protocol Transceivers Allow Designers to Replace Two Chips with a Single Device

### ISL3333xE/5xE

- Fixed-port devices
  - Simpler device that is more cost-effective
  - QFN package saves even more board space
- Support dual protocol
  - Two ports, one for RS-232 and one for RS-485
  - Selectable data rate for RS-485

## Fixed Dual Protocol Transceivers (ISL33334E)

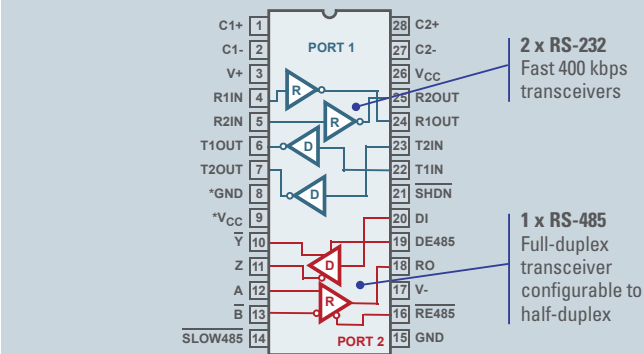

## Dual Protocol RS485/RS-232 (Fixed and Configurable)

Part Number	# of Ports	Port Assignment	V <sub>CC</sub> (V)	DR (Mbps) RS-485	DR (kbps) RS-232	Package
ISL33334E/37E	2	Fixed	3.3	20, 0.115	400	28 Ld SSOP, 40 Ld QFN
ISL33354E/57E	2	Fixed	5	20, 0.115	460	28 Ld SSOP, 40 Ld QFN
ISL3330E/1E	1	Config.	3.3	20, 0.46, 0.115	400	20 Ld SSOP, 28 Ld SSOP, 40 Ld QFN
ISL3332E/3E	2	Config.	3.3	20, 0.46, 0.115	400	20 Ld SSOP, 28 Ld SSOP, 40 Ld QFN
ISL41334E	2	Config.	5	20, 0.46, 0.115	650	40 Ld QFN
ISL81334E	2	Config.	5	20, 0.46, 0.115	650	28 Ld SSOP, 28 Ld SOIC
ISL41387E	1	Config.	5	20, 0.46, 0.115	650	40 Ld QFN
ISL81387E	1	Config.	5	20, 0.46, 0.115	650	20 Ld SSOP, 20 Ld SOIC

## Galvanically Isolated RS-485 Transceiver

### Industry's Smallest Isolated RS-485 Transceiver

#### ISL32704E

The ISL32704E isolated RS-485 transceiver provides 4Mbps bi-directional data transmission for Industrial Internet of Things networks. The high-speed device delivers industry-leading EMI and common-mode transient immunity in a small 4mm x 5mm QSOP package that's **70% smaller** than competing solutions.

- Galvanically isolated using giant magnetoresistance (GMR) technology
- 2.5kVRMS isolation; 600VRMS working voltage (50% higher than the closest competitor)
- Very low EMI, no board level shielding needed
- Supports 3V to 5V power supplies

## Giant Magnetoresistance (GMR) Technology to Provide Galvanic Isolation

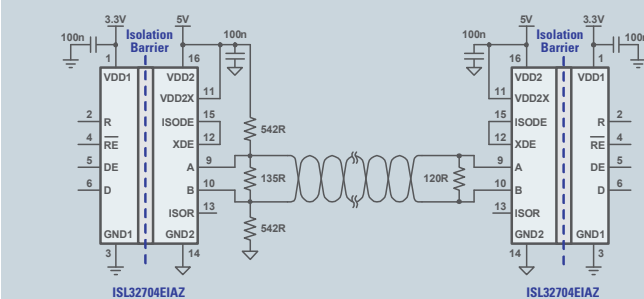

## Galvanically Isolated RS-485 Transceiver

Part Number	Data Rate	Duplex	Isolation Rating	Working Voltage	V <sub>DD1</sub>	V <sub>DD2</sub>	I <sub>DD1</sub>	I <sub>DD2</sub>	Package
ISL32740E	40Mbps	Half	2.5kV	600Vrms	3V to 5.5V	4.5V to 5.5V	3 to 4mA	5mA	16 Ld SOIC
ISL32741E	40Mbps	Half	6kV	1000Vrms	3V to 5.5V	4.5V to 5.5V	3 to 4mA	5mA	16 Ld SOIC
ISL32704E	4Mbps	Half	2.5kV	600Vrms	3V to 5.5V	4.5V to 5.5V	3 to 4mA	5mA	16 Ld QSOP, 16 Ld WSOIC



Data Converters

# HIGH SPEED ADC/DACs

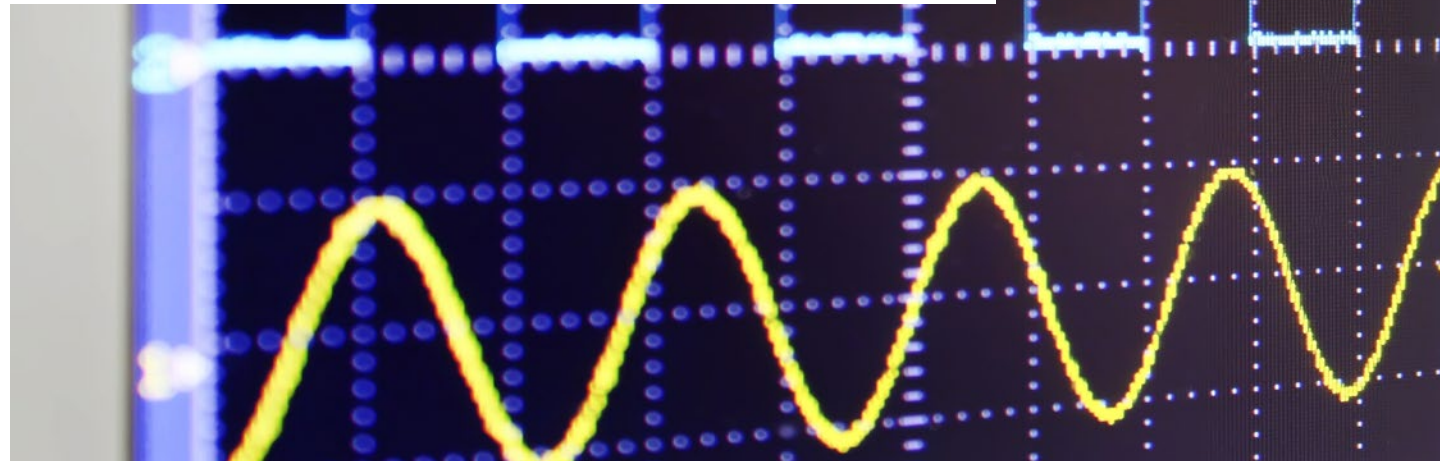

### High Speed ADCs

Innovative FemtoCharge<sup>®</sup> CMOS technology yields ultra-high performance ADCs that consume a fraction of the power of the competition.

#### Competitive Advantages

- **14-bit:** higher sampling rate (250MSPS), one-third the power (390mW) of the competition
- **12-bit:** same sampling rate (500 MSPS), less than one-fifth the power (432mW) of the competition
- **8/10-bit:** higher sampling rate (500MSPS), almost half the power (428mW) of the competition
- Superior wideband capabilities
- Compact footprint
  - The industry’s first dual 12-bit 250MSPS ADC family
  - 500 MSPS option is 2 to 3.6x smaller than the competition

#### Applications

- Communications
- Networking
- Instrumentation
- Industrial
- Video and imaging

	8-bit	10-bit	12-bit	14-bit
500+ MSPS	ISLA118P50	ISLA110P50 5510-50	ISLA112P50 5512-50	
250-350 MSPS		5610-25	5512-25 5612-25 5512H-25	5514-25
130-210 MSPS		5610-21 5610-17	5512-21 5512-17 5612-21 5612-17 5512H-21 5512H-17	5514-21 5514-17
Up to 125 MSPS		5610-12	5512-12 5612-12 5512H-12	5514-12

Pin-Compatible Families  
Simplify the selection process and enable design re-use

Single KAD55XX Dual KAD56XX

Resolution	Part Number	Speed
14-bit	ISL5957	260MSPS
	ISL5927	260MSPS, Dual
	ISL5961	210/130MSPS
	ISL5929	210/130MSPS, Dual
12-bit	ISL5857	260MSPS
	ISL5827	260MSPS, Dual
	ISL5861	210/130MSPS
	ISL5829	210/130MSPS, Dual
10-bit	ISL5757	260MSPS
	ISL5727	260MSPS, Dual
	ISL5761	210/130MSPS
	ISL5729	210/130MSPS, Dual
8-bit	ISL5627	260MSPS, Dual
	ISL5629	210/130MSPS, Dual
	HI5660	125/60MSPS

### High Speed DACs

#### Key Features

- Excellent dynamic performance (ISL5957):
  - Nyquist SFDR at 10MHz = 75dBc
  - UMTS ACPR at 19.2MHz = 71dB
- GSM SFDR at 11MHz (20MHz window) = 94dBc
- +3.3V supply, low power 103mW @130MSPS
- Adjustable full-scale output current (2 to 20mA)
- Pin compatible family of single & duals

#### Applications

- Wireless Communications
- Broadband Microwave Repeaters
- Military & SDR Radios

Data Converters

# PRECISION DATA CONVERTERS

### 24-bit Delta-Sigma Converters

- High resolution (24-bit)
- Lower conversion rate

#### Applications

- Weigh scales
- Dynamic weighing
- Manufacturing systems
- Temperature and load sensors
- Load safety systems
- Scientific instrumentation

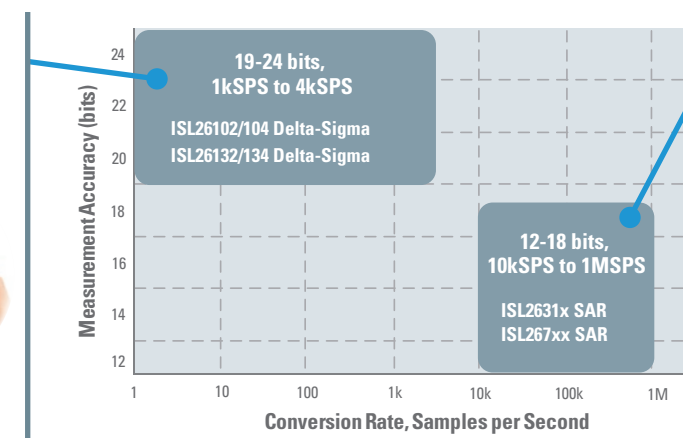

### Successive Approximation (SAR) ADCs

- Medium to high-resolution ADCs (up to 12-bit)
- High conversion rate
- Low power

#### Applications

- Process controllers
- Human-machine interface devices
- Pressure and flow sensors
- Switchgear
- Safety monitors



- Robotic controls
- Automotive systems

### 24-bit Delta-Sigma Converters

Resolution	Max Conv Rate	2-Channel	4-Channel	INL (%FS)	Noise	Power Consumption	Analog Supply Voltage Range	Digital Supply Voltage Range	Package	Technical Highlight
24-bit	4kSPS	ISL26102	ISL26104	0.0002	7nV/√Hz	33.75mW	4.75 - 5.25V	2.7 - 5.25V	24 and 28 Ld TSSOP	Programmable gain amplifier with gains of 1 to 128
	10SPS and 80SPS	ISL26132	ISL26134	0.0002	1.2μV/√Hz	50mW	5V	2.7V	24 and 28 Ld TSSOP	Up to 21.6 Noise-free bits

### SAR ADC

Resolution	Max Conv Rate	Single-channel	2-channel	4-channel	8-channel	± INL (Integral Non-Linearity) (LSB)	SFDR	Power Consumption	Analog Supply Voltage (min)	Analog Supply Voltage (max)	Pkg Type	Temp Range (°C)
8-bit	1MSPS	ISL26708	–	–	–	0.03	-68dB	3.75mW	2.7V	5.25V	DFN8, SOT8	-40 to +85
10-bit	1MSPS	ISL267440	–	–	–	0.5	-76dB	2mW	2.7V	5.25V	MSOP8, SOT8	-40 to +85
		ISL26710	–	–	–	0.1	-82dB	3.75mW	2.7V	5.25V	DFN8, SOT8	-40 to +85
12-bit	20kSPS	ISL2671286	–	–	–	1	-83dB	1.4mW	4.5V	5.25V	SOIC8	-40 to +85
	125kSPS	–	ISL26312, ISL26313	ISL26314, ISL26315	ISL26319	0.7	96dB	11mW	2.7V	5.25V	SOIC8, TSSOP16	-40 to +125
	200kSPS	ISL267817	–	–	–	1	-85dB	2.15mW	4.75V	5.25V	MSOP8, SOIC8	-40 to +85
	250kSPS	ISL26320, ISL26321, ISL26322	ISL26323	ISL26325, ISL26324	ISL26329	0.7	96dB	11mW, 15mW	2.7V	5.25V	SOIC8, TSSOP16	-40 to +125
	555kSPS	ISL267452	–	–	–	1	-76dB	3.75mW	2.7V	5.25V	SOT8	-40 to +85
	1MSPS	ISL267450/A	–	–	–	1	-82dB	3.75mW	3V	5.25V	MSOP8, SOIC8	-40 to +85
1MSPS	ISL26712	–	–	–	–	0.4	-87dB	3.75mW	2.7V	5.25V	DFN8, SOT8	-40 to +85

Data Converters

# VOLTAGE REFERENCES

Renesas offers a wide range of precision voltage references in both FGA™ and Bandgap technology.

## Accurate and Stable Voltage Reference with Floating Gate Analog Technology (FGA™)

Renesas' revolutionary Floating Gate Analog (FGA™) voltage reference circuits are not dependent on the voltage produced by a silicon junction. FGA technology produces extraordinarily accurate and stable reference voltages by storing a precise charge on a floating gate cell that is essentially unaffected by external influences such as variation in temperature, input voltage, and time.

The floating gate voltage is buffered with a high quality CMOS amplifier as shown in the simplified diagram in Figure 1.

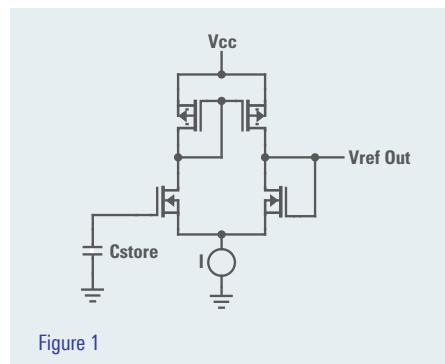

Figure 1

## Ultra Low Noise, Precision Voltage Reference

### ISL21090

The ISL21090 is an ultra low noise, high DC accuracy precision voltage reference with a wide input voltage range of 3.7V to 36V. The ISL21090 is ideal for high-end instrumentation, data acquisition and processing applications requiring high DC precision where low noise performance is critical.

- Reference output voltage options:
  - 1.25V, 2.5V, 5.0V, 7.5V
- Initial accuracy: ±0.003% (1.25V option)
- Output voltage noise: 1µV<sub>P-P</sub> typ (0.1Hz to 10Hz) (1.25V option)
- Supply current: 750µA typ (1.25V option)
- Tempco: 7ppm/°C max
- Output current capability: 20mA
- Line regulation: 8ppm/V (1.25V option)
- Load regulation: 2.5ppm/mA (1.25V option)

## Temperature Drift (Coefficient)

ISL21090 Typical Temperature Coefficient

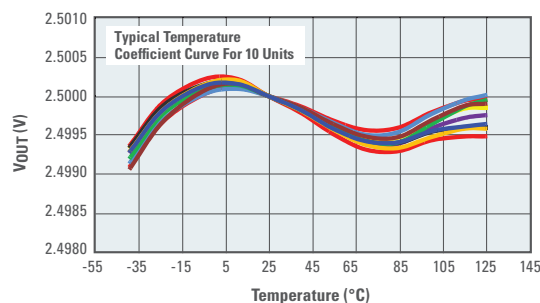

## Long Term Drift

ISL21090 Long Term Drift Data (1000 Hrs)

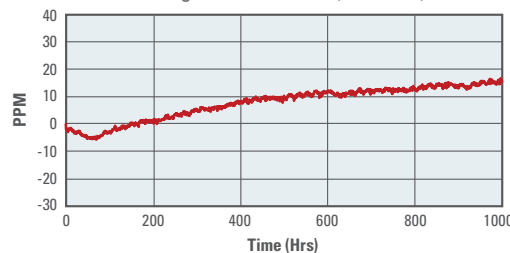

## Precision Voltage References

Type	Part Number	V <sub>OUT</sub>											Temp Coefficient (max)	I <sub>S</sub> (typ)	I <sub>S</sub> (max)	V <sub>S</sub> (min)	V <sub>S</sub> (max)	Initial Accuracy (% V <sub>OUT</sub> @2.5V)	Output Noise (0.1Hz to 10Hz) (typ)	Hysteresis (ppm)	Pkg Type	Temp Range (°C)				
		0.9V	1.024V	1.2V	1.25V	1.5V	1.8V	2.048V	2.5V	2.6V	3V	3.3V											4.096V	5V	7.5V	
Low Noise	ISL21007				•			•	•								3ppm/°C (B grade)	–	150µA	2.7V	5.5V	<0.08%	4.5µV <sub>PP</sub>	50	SOIC8	-40 to 125
	ISL21090				•			•									7ppm/°C	750µA (1.25V Option)	1.28mA	3.7V	36V	±0.03% (1.25V Option)	1.0µV <sub>PP</sub> (1.25V option)	–	SOIC8	-40 to 125
Low Cost	ISL21010		•		•	•	•	•	•	•	•						50ppm/°C	48µA	100µA	2.2V	5.5V	0.2%	58µV <sub>PP</sub> (2.048V option)	100	SOT3	-40 to 125
	ISL21080	•	•	•	•	•	•	•	•	•	•	•					50ppm/°C	300nA	1.5µA	2.7V	5.5V	<0.7%	30µV <sub>PP</sub>	100	SOT3	-40 to 85
NanoPower	ISL60002		•	•	•	•	•	•	•	•	•						20ppm/°C	350nA	900nA	2.7V	5.5V	<0.49%	30µV <sub>PP</sub>	100	SOT3	-40 to 85
	X60003											•	•				10ppm/°C (B grade)	500nA	900nA	4.5V	9V	<0.1%	30µV <sub>PP</sub>	150/100	SOT3	-40 to 85
With Comparator	ISL21440	1.182V ±0.5% with Comparator											–	0.46µA	6.5µA	2V	11V	0.5%	–	Programmable	DFN8, MSOP8	-40 to 125				

Data Converters

# DIGITAL POTENTIOMETERS

Digital potentiometers replace mechanical potentiometers and trim resistors in applications where digital control allows microprocessor interfacing and extended functionality. Compared to mechanical potentiometers, electronic potentiometers are more accurate, easier to adjust, and they reduce manufacturing complexity.

## Lowest Voltage

Specification	Renesas DCP	Competition	Renesas Benefit
Analog Voltage	1.7V to 5.5V	1.8V to 5.5V 2.7V to 5.5V	Operational when battery starts draining.
Digital Voltage	1.2V to 5.5V	Same as analog voltage, lowest is 1.8V	Eliminate level shifter for I <sup>2</sup> C/SPI when µC has low voltage I/O pins.
Low Current Consumption	2.5µA - 1CH 3µA - 2CH 5µA - 4CH	Up to 2x more power consumption	Drains up to 50% less battery power.

## Smaller Package

Type	Renesas Part Number	Renesas DCP	Competition	Renesas Benefit
Single	ISL23315, ISL23415, ISL23318, ISL23418	µTQFN (2.1x1.6mm)	SC-70 (2x2.1mm)	20% Smaller
Dual	ISL23325, ISL23425, ISL23328, ISL23428	µTQFN (2.6x1.8mm)	QFN (4x4mm)	48% Smaller
Quad	ISL23345, ISL23445, ISL23348, ISL23448	QFN (3x4mm)	QFN (4x4mm)	25% Smaller

## Digital Potentiometer Portfolio

- **Single 16-Tap (4-bits)**  
X9116 – 10kΩ, Up-Down
- **Single 32-Tap (5-bits)**  
D X9314 – 10kΩ, Log Taper, Up-Down  
X9315 – 10kΩ / 50kΩ / 100kΩ, Up-Down  
D X9511 – 10kΩ, Push Button
- **Single 100-Tap (~6.65-bits)**  
X9317 – 10kΩ / 50kΩ / 100kΩ, Up-Down  
X9318 – 10kΩ, Up-Down  
X9319 – 10kΩ / 50kΩ, Up-Down  
D X9C102 – 1kΩ, Up-Down  
D X9C103 – 10kΩ, Up-Down  
D X9C104 – 100kΩ, Up-Down  
D X9C503 – 50kΩ, Up-Down  
D X9C303 – 32kΩ, Log Taper, Up-Down
- **Single 128-Tap (7-bits)**  
ISL22316 – 10kΩ, I<sup>2</sup>C  
ISL22317 – 10kΩ, 1% Tolerance, I<sup>2</sup>C  
E ISL95311 – 10kΩ, I<sup>2</sup>C  
E ISL95310 – 50kΩ, Up-Down
- **Single 256-Tap (8-bits)**  
ISL95810 – 10kΩ / 50kΩ, I<sup>2</sup>C
- **Single 1024-Tap (10-bits)**  
D X9110 – 100kΩ, SPI  
X9111 – 100kΩ, SPI  
D X9118 – 100kΩ, 2-Wire  
X9119 – 100kΩ, 2-Wire
- **Dual 128-Tap (7-bits)**  
ISL22326 – 10kΩ, I<sup>2</sup>C
- **Dual 256-Tap (8-bits)**  
X95820 – 10kΩ / 50kΩ, I<sup>2</sup>C  
D X9268 – 50kΩ / 100kΩ, 2-Wire  
D ISL22424 – 10kΩ, SPI
- **Quad 64-Tap (6-bits)**  
D X9408 – 2.5kΩ / 10kΩ, 2-Wire
- **Quad 128-Tap (7-bits)**  
ISL22346 – 10kΩ / 50kΩ, I<sup>2</sup>C
- **366Quad 256-Tap (8-bits)**  
X95840 – 10kΩ / 50kΩ, I<sup>2</sup>C  
D X9250 – 50kΩ / 100kΩ, SPI  
X9251 – 50kΩ, SPI  
X9252 – 2kΩ / 10kΩ, 2-Wire  
D X9258 – 50kΩ / 100kΩ, 2-Wire  
X9259 – 50kΩ, 2-Wire

- ### Special Function DCPs
- **Dual Audio DCP – Integrated Output Buffer Amps and Audio Detect**  
ISL22102 – 32kΩ, Log Taper, Push Button, 0 to -72dB Dynamic Range
  - **Low Voltage 1% Tolerant Precision DCP & Low Temperature Coefficient**  
ISL22317 – 10kΩ, I<sup>2</sup>C
  - **TFT/LCD Programmable VCOM Calibrator (128 Step)**  
ISL45041 – I<sup>2</sup>C  
ISL45042 – Up-Down
  - **Military Temperature (-55°C to 125°C) Non-Volatile DCP**  
ISL22316W (Single) – 10kΩ, I<sup>2</sup>C  
ISL22326W (Dual) – 10kΩ, I<sup>2</sup>C  
ISL22346W (Quad) – 10kΩ, I<sup>2</sup>C

## Volatile (No EEPROM Memory)





- **Single 32-Tap (5-bits)**  
ISL23511 – 10kΩ, Push Button  
ISL90461 – 10kΩ / 50kΩ / 100kΩ, Up-Down, 2-Pin, Rheostat  
ISL90462 – 10kΩ / 50kΩ, Up-Down, 2-Pin, Voltage Divider Only
- **Single 128-Tap (7-bits)**  
ISL90726 – 10kΩ / 50kΩ, I<sup>2</sup>C, Rheostat  
ISL90727/28 – 10kΩ / 50kΩ, I<sup>2</sup>C, Voltage Divide Only  
ISL23318 – 10kΩ / 50kΩ / 100kΩ, I<sup>2</sup>C, Low Voltage  
ISL23418 – 100kΩ, SPI, Low Voltage
- **Single 256-Tap (8-bits)**  
ISL23315 – 100kΩ, I<sup>2</sup>C, Low Voltage  
ISL23415 – 100kΩ, SPI, Low Voltage
- **Dual 32-Tap (5-bits)**  
ISL22102 – 32kΩ, Log Taper, Audio Detect, Push Button
- **Dual 128-Tap (7-bits)**  
ISL23328 – 10kΩ / 100kΩ, I<sup>2</sup>C, Low Voltage  
ISL23428 – 10kΩ / 100kΩ, SPI, Low Voltage
- **Dual 256-Tap (8-bits)**  
ISL23325 – 10kΩ / 100kΩ, I<sup>2</sup>C, Low Voltage  
ISL23425 – 10kΩ / 100kΩ, SPI, Low Voltage
- **Quad 256-Tap (8-bits)**  
ISL90841 – 50kΩ, I<sup>2</sup>C  
ISL90842 – 10kΩ / 50kΩ, I<sup>2</sup>C

E Extended positive terminal voltage  
D Positive and negative terminal voltage

# REAL-TIME CLOCKS



## Pick the Right RTC to Fit Your Design Needs

 <p><b>Basic</b></p> <ul style="list-style-type: none"> <li>External crystal (no external caps required), minimal features</li> </ul>	 <p><b>Low Cost</b></p> <ul style="list-style-type: none"> <li>External crystal, battery backup, 1 to 8 bytes SRAM</li> </ul>	 <p><b>Feature Rich</b></p> <ul style="list-style-type: none"> <li>External crystal, temperature compensation, ≥ 128 bytes SRAM or EEPROM memory, tamper/event detection, unique ID, etc.</li> </ul>	 <p><b>High Accuracy Modules</b></p> <ul style="list-style-type: none"> <li>Integrated crystal and temperature compensation</li> </ul>
--	--	---	---

## High Accuracy 3-in-1 RTC Module (RTC + Embedded Crystal + Temp Sensor)

### ISL12022M

- ±5ppm accuracy (-40°C to +85°C)
  - Factory programmed RTC for optimal accuracy
  - On-board temperature sensor
  - Embedded crystal
  - Reliable timekeeping & power management
  - Backup battery management
  - V<sub>DD</sub> and battery status monitors and switchover timestamp
  - Battery ReSeal™ function extends battery shelf life
- User programmability
  - I<sup>2</sup>C interface
  - 128 bytes battery-backed user SRAM
- Solution for industrial applications
  - Provides low-drift time source for patient event time stamp
  - Reliable clock solution for patient monitoring (ECG)

## Block Diagram

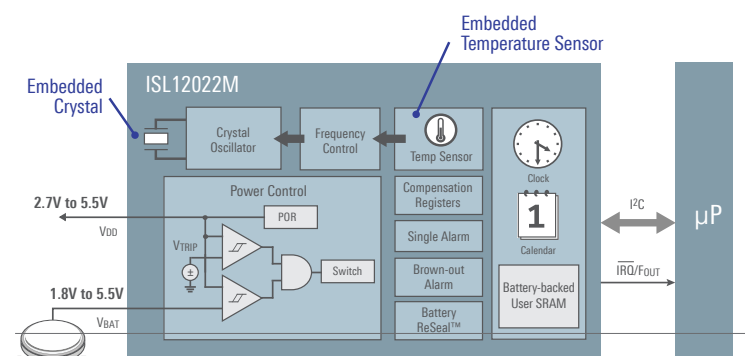

## High Accuracy Even in Extreme Temperature Conditions

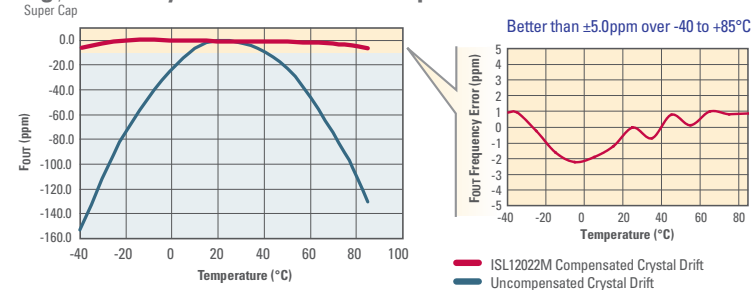

## Real-Time Clocks

Category/Special Features	Part Number	Other Functions									Memory	Package	
		Event Detection	Time Stamp	Batt Sw Timestamp	Auto DST Adjust	Temp Comp	Power Monitor	Unique ID	Integrated Crystal	Crystal Capacitor			
High Accuracy RTC Module	With Embedded Crystal & Temp Compensation	ISL12020M			•	•	•	•		•		128 Bytes SRAM	20 Ld DFN
		ISL12022M			•	•	•	•		•		128 Bytes SRAM	20 Ld SOIC
Feature Rich RTC	With On-Chip Temp Sensor	ISL12022			•	•	•	•				128 Bytes SRAM	20 Ld SOIC
	With Embedded Unique ID	ISL12024							•			512x8-Bit EEPROM	8 Ld SOIC, 8 Ld TSSOP
		ISL12025							•			512x8-Bit EEPROM	8 Ld SOIC
	With Integrated EEPROM & CPU Supervisory Function	ISL12026A										512x8-Bit EEPROM	8 Ld SOIC, 8 Ld TSSOP
		ISL12027A										512x8-Bit EEPROM	8 Ld TSSOP
		ISL12028									512x8-Bit EEPROM	14 Ld SOIC, 14 Ld TSSOP	
Low Cost	With Battery Backup	ISL12008											8 Ld SOIC
		ISL12082											8 Ld SOIC
	With Battery-Backed SRAM	ISL1208										2 Bytes SRAM	8 Ld MSOP, 8 Ld SOIC, 8 Ld TDFN
		ISL1218										8 Bytes SRAM	8 Ld MSOP, 8 Ld SOIC
		ISL1220										8 Bytes SRAM	10 Ld MSOP
	With Battery-Backed SRAM, Event Detection	ISL1209	•									2 Bytes SRAM	10 Ld MSOP
		ISL1219	•	•								2 Bytes SRAM	10 Ld MSOP
		ISL1221	•	•								2 Bytes SRAM	10 Ld MSOP
	Basic	With IRQ, Alarm, Timers	ISL12057								•		
ISL12058													

Discrete

# PHOTOCOUPLEDERS

Providing Highly Reliable, High Accuracy Small Footprint Solutions

**Renesas Strength**

**High Reliable**

IGBT Drive (PS9332)

- Built-in IGBT protection to prevent from overcurrent
- Miller clamp and DESAT detection

**High Accuracy**

Isolation Amp

- Gain error <1%
- High temperature endurance (TA = 110°C)

**Small Package + High Temp Operation**

SO16 (8mm) LSDIP (14.5mm) LS05 (8mm)

- TA = 125°C guaranteed

## Featured Products

### IGBT Drive Photocouplers

- A gate drive coupler drives the gate of an IGBT device. Available output currents are 0.6A and 2.5A
- The package lineup includes LS05 and SDIP ensuring 8mm creepage distance, as well as a 14.5mm creepage type, LSDIP.

#### LSDIP (creepage distance 14.5mm)

Isolation voltage: 7.5kVr.m.s.



- Reduces the power loss of customer systems at higher voltages.
- Substantially reduces the customer's cost in comparison with conventional in comparison with conventional

#### LS05 (height: 2.3mm max.)

TA = 125°C guaranteed

- 8mm creepage to support 400V-class equipment
- TA = 125°C for greater heat dispersion design margin
- Smaller mounting area than conventional SDIP package
  - Smaller footprint and lower BOM cost

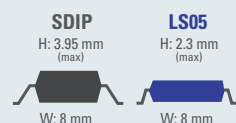

### Analog or Digital Isolation Amplifiers

- Isolation amplifiers (analog output) enable accurate current and voltage monitoring
- Delta-sigma modulator (digital output) are optically coupled one-bit data stream output isolators.

#### PS8352A (analog output)

Isolation amplifier produces differential output at eight times the voltage of the input analog voltage.

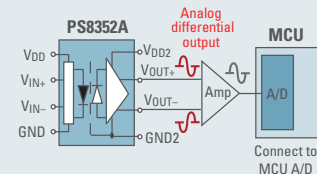

#### PS9352A (digital output)

Delta-sigma modulator converts the input analog voltage to bit-by-bit digital data.

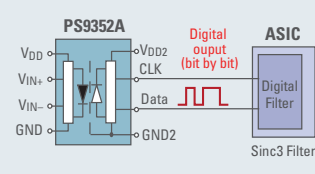

## IC Output Photocouplers

Category	Function	Output	Vcc/Vdd	DIP8 7mm/8mm	SDIP6/8 7mm/8mm	LSDIP8 14.5mm	LS05 8mm	S05 4.2mm	S016 8mm
Motor Drive	IGBT Drive	Digital	35V 2.5/2.0A	PS9531	PS9331 PS9332	PS9905	PS9031	—	PS9402
			35V 0.6A	PS9506	PS9307A	—	—	—	—
Motor Drive	IPM Drive	Digital	>20V	PS9513	PS9313 PS9303 PS9309	—	PS9013 PS9009	PS9113	—
				PS8551A	PS8352A	—	—	—	—
Current/Voltage Detection	Isolation Amplifier	Analog	5V	PS8551A	PS8352A	—	—	—	—
	ΔΣ Modulator	Digital	5V	PS9551A	PS9352A	—	—	—	—
Communication	15Mbps	CMOS	5V	—	PS9351	—	—	PS9151	PS9851-1 PS9851-2
		Totem Pole	5V	—	—	—	—	PS9123	—
	10Mbps	Open Collector	5V	PS9587	PS9317	—	PS9001	PS9117A	PS9817A-1 PS9817A-2
			3.3V/5V	—	PS9324	PS9924	—	PS9124	PS9821-1 PS9821-2
	1Mbps	Digital	3.3V/5V	—	—	—	—	PS9122	PS9822-1 PS9822-2
		Analog	35V	PS8501 PS8502	PS8302	PS8902	—	PS8101	—

## Transistor Output Photocouplers

Input	Output	Function	DIP4 7mm	LSOP 8mm	SSOP 5mm	SSOP 4mm	SSOP Common Lead 4mm	Flat Lead 4mm
DC	Single	General Purpose	—	—	PS2701A-1	PS2801C-1 PS2801C-4	—	—
		High Temp. (110, 115°C)	PS2561D-1 PS2561F-1	PS2381-1	PS2761B-1	PS2861B-1	—	—
		High Voltage (120V)	—	—	PS2703-1	—	—	—
		Low Input	—	—	PS2711-1	PS2811-1 PS2811-4	PS2841-4A PS2841-4B	PS2911-1 PS2913-1
	Darlington	General Purpose	PS2562-1	—	PS2702-1	PS2802-1 PS2802-4	—	—
		High Voltage (350V)	PS2533-1 PS2535-1	—	PS2733-1	PS2833-1 PS2833-4	—	—
AC	Single	General Purpose	PS2565-1	—	PS2705A-1	PS2805C-1 PS2805C-4	—	—
		Low Input	—	—	PS2715-1	PS2815-1 PS2815-4	PS2845-4A	PS2915-1
	Darlington	General Purpose	PS2506-1	—	PS2706-1	—	—	—

Discrete

# TRIACS/THYRISTORS



## Reliable Triacs/Thyristors with New Planar Structure

### Low Failure Rate

- Actual failure rate: 0.01ppm or less (long service life)

### Ability to Withstand Voltage Stress

- Channel stopper structure for stable performance and ability to withstand voltage stress

	Renesas Planar Structure	Old Structure from 1980s	Old Planar Structure
Structural Comparison	<p><b>Planar structure</b> Voltage tolerance to spare</p> <p>High quality and able to withstand voltage stress</p>	<p><b>Mesa glass structure</b></p> <p>Fragile glass structure</p> <p>Bubbles characteristic of glass</p>	<p><b>Planar structure</b> Structure with no voltage tolerance to spare</p> <p>Inability to withstand voltage stress</p> <p>Damage in horizontal direction when voltage applied</p>
Comparison Details	<ul style="list-style-type: none"> <li>Channel stopper provides stable voltage tolerance (stable under high-temperature, high-voltage testing: high reliability).</li> <li>Distance (a), which determines voltage tolerance, is long (ability to withstand overvoltage: rugged)</li> </ul>	<ul style="list-style-type: none"> <li>Application of foreign matter (lead glass) causes high off-current (current leakage) at high temperatures.</li> <li>The bubbles characteristic of glass reduce tolerance of physical stress and increase fragility (brittleness).</li> </ul>	<ul style="list-style-type: none"> <li>Unstable voltage tolerance from lack of countermeasures (fails high-temperature, high-voltage testing: low reliability)</li> <li>Distance (a), which determines voltage tolerance, is short (ability to withstand overvoltage: poor, easily damaged)</li> </ul>
Voltage Stress	Lightning surge tests (3A version) No damage at 12kV	Lightning surge tests (3A version) No damage at 12kV	Lightning surge tests (3A version) Damage at 8kV

## Washer Example Triacs for Motors, Valves and Relays

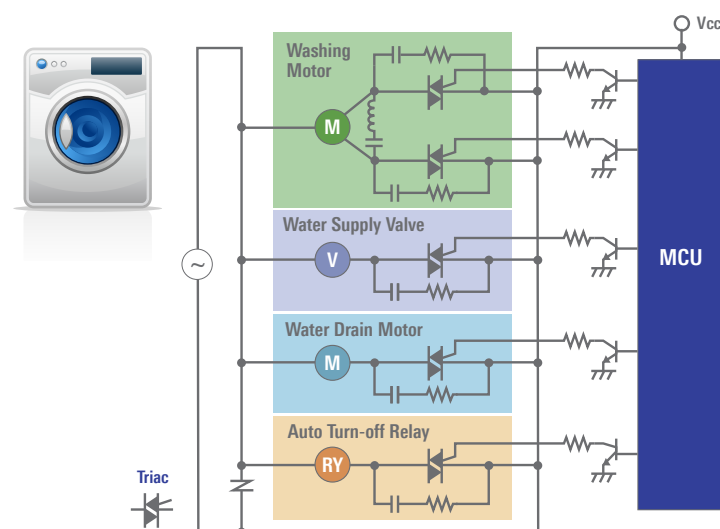

## Triacs Part Numbers

	Main Voltage	
	AC100V ~ 120V	AC200V ~ 240V
■ Washing Motor	BCR8PM-14LJ BCR8FM-14LJ BCR10PM-14LJ BCR10FM-14LJ	BCR8PM-14LJ BCR8FM-14LJ
■ Water Supply Valve ■ Drain Valve ■ Turn-off Relay	BCR1AM-12A#FD0 BCR08DS-14A	BCR08AM-14A#FD0 BCR08DS-14A
Bathwater Pump	BCR3FM-12RB#FA0 BCR5FM-14LJ	BCR3FM-12RB#FA0 BCR3FM-14LB BCR3AS-14B

## Triac Product Lineup

### Triacs (600V)

Part Number	VDRM (V)	IT (RSM) (A)	ITSM (A)	IGT (mA)	Tj (°C)	Package
BCR08AM-12A	600	0.8	8	5	125	TO-92
BCR08AS-12A	600	0.8	8	5	125	UPAK
BCR1AM-12A	600	1	10	7	125	TO-92
BCR3AS-12B	600	3	30	15	150	MP-3A
BCR5AS-12B	600	5	50	30	150	MP-3A
BCR3PM-12LG	600	3	30	20	150	TO-220F
BCR30AM-12LB	600	30	300	50	150	TO-3P
BCR40RM-12LB	600	40	400	50	150	TO-3PFM

### Triacs (700V and high voltage tolerance)

Part Number	VDRM (V)	IT (RSM) (A)	ITSM (A)	IGT (mA)	Tj (°C)	Package
BCR08AM-14A	700	0.8	8	5	125	TO-92
BCR3AS-14B	700	3	30	30	150	MP-3A
BCR3PM-14LG	700	3	30	30	150	TO-220F
BCR5AS-14LJ	700	5	50	30	150	MP-3A
BCR5PM-14LJ BCR5FM-14LJ	700	5	50	30	150	TO-220F TO-220FP
BCR8AS-14LJ	700	8	80	30	150	MP-3A
BCR8PM-14LJ BCR8FM-14LJ	700	8	80	30	150	TO-220F TO-220FP
BCR10PM-14LJ BCR10FM-14LJ	700	10	100	30	150	TO-220F TO-220FP
BCR12PM-14LJ BCR12FM-14LJ	700	12	120	30	150	TO-220F TO-220FP
BCR16PM-14LJ BCR16FM-14LJ	700	16	160	30	150	TO-220F TO-220FP
BCR20PM-14LJ BCR20FM-14LJ	700	20	200	30	150	TO-220F TO-220FP
BCR25PM-14LJ BCR25FM-14LJ	700	25	250	50	150	TO-220F TO-220FP
BCR20RM-30LA	1,500	20	200	50	150	TO-3PFM

## Package Lineup

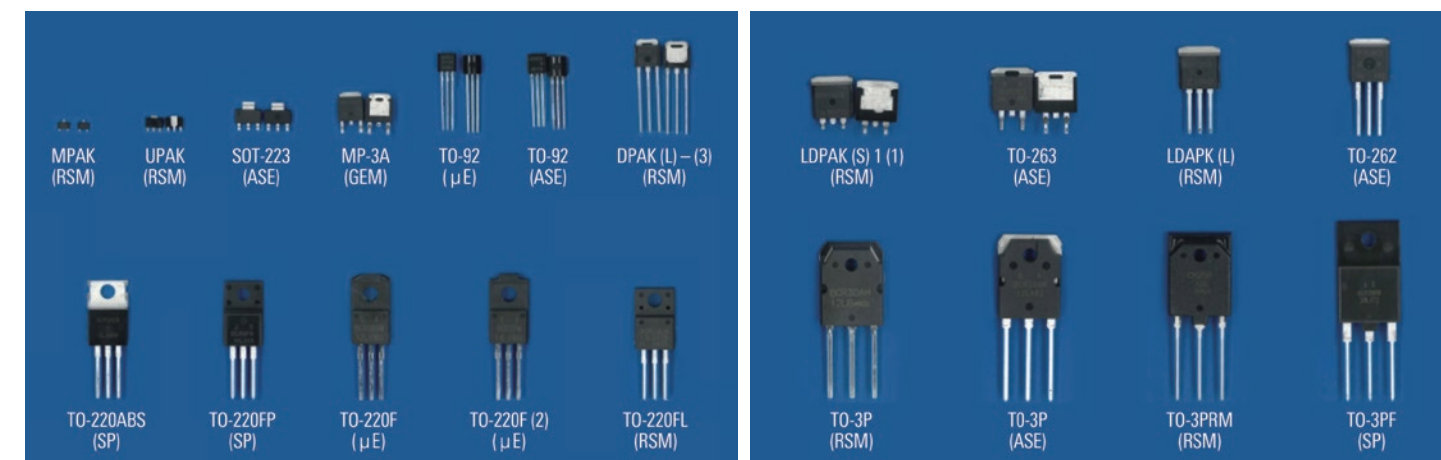

Discrete

# IGBTs

Ultra-low loss technology with improved power efficiency. Reduce heat generation.

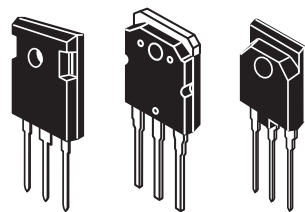

### Ultra-low Loss and Fast Switching

- New trench field stop structure IGBT<sup>1</sup> technology enables low loss and fast switching.
- Renesas keeps top performance by continuous improvement of wafer process.

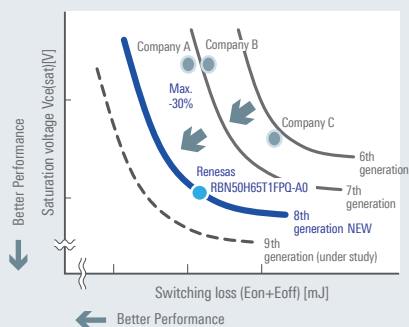

Note: 1. An IGBT structure in which the gate is shaped like a channel in the wafer surface and an electric field relaxation structure is formed relative to the back side of the thin wafer

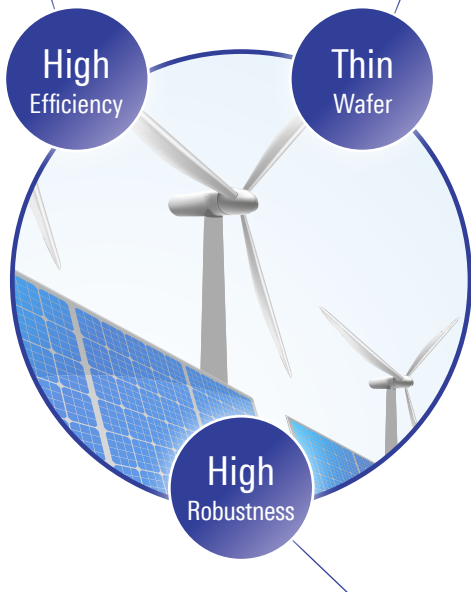

### Ultra-thin Wafer Technology

- Ultra-thin wafer reduces conduction loss

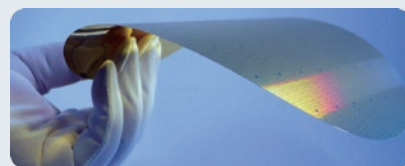

### Guaranteed Robustness for Reliable Application

- Optimized cell & guard ring structure
- Various tsc for each application
- Tj = 175 deg. guarantee
- Vge = ±30V guarantee

### PFC Evaluation Board Populated with IGBTs

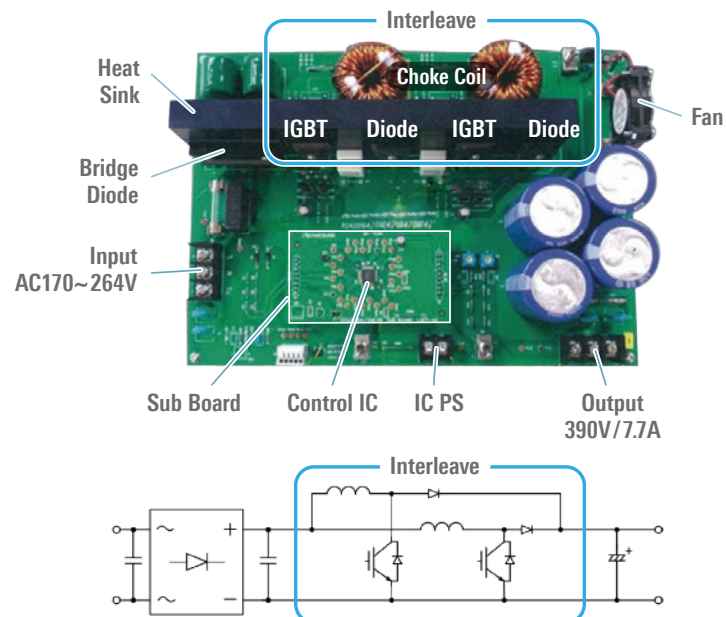

### Superior IGBT efficiency

- Renesas IGBTs provide higher efficiency than competitor in both peak and heavy-load conditions

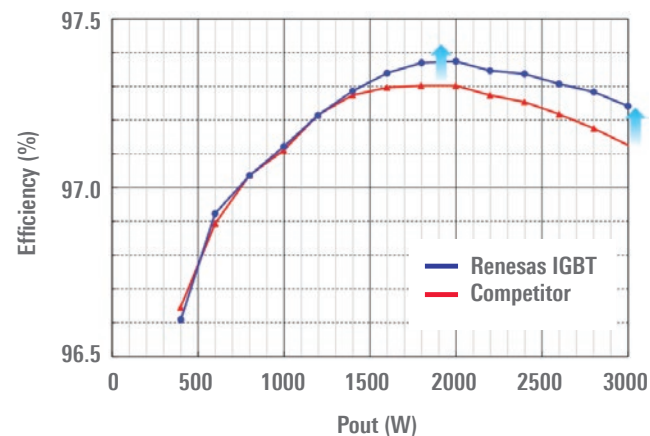

# GENERAL SWITCHING MOSFETS

Package	Part No.	VDSS (V)	ID (A)	QG (nC) typ.	R <sub>DS(on)</sub> (Ω) max.			Ciss (pF) typ.
					10V [8V]	4V [4.5V]	2.5V [1.8V]	
6-pin HUSON 2020	UPA2660T1R	20	4	4.5	—	0.042	0.062	330
	UPA2690T1R	20/-20	4/-3	4.5/5.1	—	0.042/0.079	0.062/0.105	330/473
	UPA2600T1R	20	7	7.9	—	0.0138	0.0191	870
	UPA2672T1R	-12	-4	5	—	0.067	0.092	486
	UPA2630T1R	-12	-7	11.3	—	0.028	0.035	1260
	UPA2670T1R	-20	-3	5.1	—	0.079	0.105	473
	UPA2631T1R	-20	-6	12.5	—	0.032	0.041	1240
8-pin HVSON-3333	UPA2821T1L	30	26	51	0.0038	0.0105	—	2490
	UPA2822T1L	30	34	83	0.0026	0.0075	—	4660
	UPA2813T1L	-30	-27	80	0.0062	0.013	—	3130
	UPA2812T1L	-30	-30	100	0.0048	0.0099	—	3740
8-pin HVSON-6051	UPA2739T1A	-30	-85	153	0.0028	0.0057	—	6050
	UPA2764T1A	30	130	180	0.0011	0.00245	—	7930
	UPA2765T1A	30	100	152	0.0013	0.0029	—	6550
	UPA2766T1A	30	130	257	0.00088	0.00182	—	10850
HSO8-8 dual	NP30N04QUK	40	30	27	0.008	—	—	1600
HWSON-8	UPA2826T1S	20	27	37	0.0043	0.0048	0.0099	3610
	UPA2820T1S	30	22	50	0.0053	0.014	—	2330
	UPA2825T1S	30	24	57	0.0046	0.012	—	2600
	RJK03M5DNS	30	25	10.4	0.0063	0.0084	—	1350
	RJK1028DNS	100	4	3.7	0.165	0.18	—	450
	UPA2816T1S	-30	-17	33.4	0.0155	0.045	—	1160
	UPA2815T1S	-30	-21	47	0.011	0.023	—	1760
	UPA2814T1S	-30	-24	74	0.0078	0.0145	—	2800
LFAK	RJK0332DPB-01	30	35	14	0.0047	0.007	—	2180
	RJK0330DPB-01	30	45	27	0.0027	0.0039	—	4300
	RJK0328DPB-01	30	60	42	0.0021	0.0029	—	6380
	RJK0451DPB	40	35	14	0.007	0.0096	—	2010
	RJK0454DPB	40	40	25	0.0049	—	—	2000
	RJK0452DPB	40	45	26	0.0035	0.0047	—	4030
	RJK0455DPB	40	45	34	0.0038	—	—	2550
	RJK0456DPB	40	50	39	0.0032	—	—	3000
	RJK0651DPB	60	25	15	0.014	0.018	—	2030
	RJK0654DPB	60	30	27	0.0083	—	—	2000
	RJK0652DPB	60	35	29	0.007	0.009	—	4100
	RJK0656DPB	60	40	40	0.0056	—	—	3000
	RJK0653DPB	60	45	42	0.0048	0.0061	—	6100
	RJK0851DPB	80	20	14	0.023	0.028	—	2050
	RJK0854DPB	80	25	27	0.013	—	—	2000
	RJK0852DPB	80	30	28	0.012	0.014	—	4150
RJK0855DPB	80	30	35	0.011	—	—	2550	
RJK1051DPB	100	15	15	0.039	0.046	—	2060	
RJK1054DPB	100	20	27	0.022	—	—	2000	
RJK1055DPB	100	23	35	0.017	—	—	2550	
RJK1053DPB	100	25	43	0.013	0.015	—	6160	
RJK1056DPB	100	25	41	0.014	—	—	3000	

## General Switching MOSFET Product Lineup

Package	Part No.	VDSS (V)	ID (A)	QG (nC) typ.	R <sub>DS(on)</sub> (Ω) max.			Ciss (pF) typ.
					10V [8V]	4V [4.5V]	2.5V [1.8V]	
MP-25 / TO-220AB	2SK3404	30	40	25	0.014	0.021	–	1400
	2SK3424	30	48	34	0.0115	0.017	–	1900
	2SK3433	60	40	30	0.026	0.041	–	1500
	2SK3480	100	50	74	0.031	0.036	–	3600
	2SK3479	100	83	210	0.011	0.013	–	11000
	2SJ602	-60	-20	26	0.073	0.107	–	1300
	2SJ603	-60	-25	38	0.048	0.075	–	1900
	2SJ605	-60	-65	87	0.02	0.031	–	4600
	2SJ606	-60	-83	120	0.015	0.023	–	4800
	MP-25Z / TO-220SMD	2SJ602-Z	-60	-20	26	0.073	0.107	–
2SJ606-Z		-60	-83	120	0.015	0.023	–	4800
MP-25ZK / TO-263	2SK3901-ZK	60	60	40	0.013	0.0165	–	1950
MP-25ZP / TO-263	NP60N04PDK	40	60	42	0.00395	0.0088	–	2450
	NP89N04PDK	40	90	68	0.00295	0.0062	–	3900
	NP60N06PDK	60	60	37	0.0079	0.012	–	2400
	2SK3812-ZP	60	110	250	0.0028	0.0037	–	16800
MP-3 / TO-251	2SK3366	30	20	15	0.021	0.033	–	730
	2SK3365	30	30	25	0.014	0.021	–	1300
	2SK3385	60	30	30	0.028	0.045	–	1500
	2SK3386	60	34	39	0.021	0.036	–	2100
	2SK3484	100	16	20	0.125	0.148	–	900
	2SK3482	100	36	72	0.033	0.039	–	3600
	2SJ598	-60	-12	15	0.13	0.19	–	720
	2SJ599	-60	-20	26	0.075	0.111	–	1300
	2SJ601	-60	-36	63	0.031	0.046	–	3300
	MP-3A / TO-252	RJK4532DPD	450	4	9	2.3	–	–
RJK5033DPD		500	6	–	1.3	–	–	600
MP-3Z / TO-252	2SK3366-Z	30	20	15	0.021	0.033	–	730
	2SK3365-Z	30	30	25	0.014	0.021	–	1300
	2SK3367-Z	30	36	49	0.009	0.012	–	2800
	2SK3385-Z	60	30	30	0.028	0.045	–	1500
	2SK3386-Z	60	34	39	0.021	0.036	–	2100
	2SK3814-Z	60	60	95	0.0087	0.0105	–	5450
	2SK3484-Z	100	16	20	0.125	0.148	–	900
	2SK3482-Z	100	36	72	0.033	0.039	–	3600
	2SJ598-Z	-60	-12	15	0.13	0.19	–	720
	2SJ599-Z	-60	-20	26	0.075	0.111	–	1300
	2SJ601-Z	-60	-36	63	0.031	0.046	–	3300
	MP-3ZK / TO-252	2SK3484-ZK	100	16	20	0.125	0.148	–
2SJ687-ZK		-20	-20	57	–	0.007	0.02	4400
N0400P		-40	-15	16	–	0.04	0.073	1400
2SJ598-ZK		-60	-12	15	0.13	0.19	–	720
2SJ599-ZK		-60	-20	26	0.075	0.111	–	1300
2SJ601-ZK		-60	-36	63	0.031	0.046	–	3300

Package	Part No.	VDSS (V)	ID (A)	QG (nC) typ.	R <sub>DS(on)</sub> (Ω) max.			Ciss (pF) typ.
					10V [8V]	4V [4.5V]	2.5V [1.8V]	
MP-3ZP / TO-252	NP60N04VDK	40	60	42	0.00385	0.0086	–	2450
	NP75N04VDK	40	75	27	0.0057	0.0126	–	1630
	NP90N04VLK	40	90	68	0.0028	0.006	–	3800
	NP45N06VDK	60	45	25	0.0116	0.0196	–	1530
	NP90N06VDK	60	90	63	0.0053	0.0082	–	4000
MP-45F / TO-220	2SK3715	60	75	145	0.006	0.0095	–	8400
	2SK3793	100	12	21	0.125	0.148	–	900
Power SOP8	UPA3753GR	60	5	13.4	0.056	0.072	–	640
	UPA2738GR	-30	-10	37	0.015	0.029	–	1450
	UPA2737GR	-30	-11	45	0.013	0.025	–	1750
	UPA2736GR	-30	-14	80	0.007	0.0135	–	3400
SOP8	UPA2735GR	-30	-16	195	0.005	0.0078	–	6250
	RJK0354DSP	30	16	12	0.007	0.0105	–	1740
TO-220	N0439N	40	90	68	0.0033	–	–	3900
	N0412N	40	100	100	0.0037	–	–	5550
	N0604N	60	82	75	0.0065	–	–	4150
	N0602N	60	100	133	0.0046	–	–	7730
TO-220FL	RJK5030DPP-M0	500	5	13	1.6	–	–	550
	RJK5033DPP-M0	500	6	-	1.3	–	–	600
TO-220FP	RJK0703DPP-A0	75	70	56	0.0067	–	–	4150
	RJK1003DPP-A0	100	50	59	0.011	–	–	4150
	RJK1002DPP-A0	100	70	94	0.0076	–	–	6450
	RJK1001DPP-A0	100	80	147	0.0055	–	–	10000
	RJK5035DPP-A0	500	10	23	0.85	–	–	765
	RJK6006DPP-A0	600	5	19	1.6	–	–	600
	RJK6035DPP-A0	600	6	20	1.37	–	–	765
	TO-262	N0434N	40	100	100	0.0037	–	–
N0603N		60	100	133	0.0046	–	–	7730
TO-263	N0413N	40	100	100	0.0033	–	–	5550
	N0601N	60	100	133	0.0042	–	–	7730
WPAK	RJK03M5DPA	30	30	10.4	0.0065	0.0086	–	1350
	RJK0353DPA	30	35	14	0.0052	0.0076	–	2180
	RJK03M2DPA	30	45	21.2	0.0028	0.0037	-	2750
	RJK03M1DPA	30	50	25	0.0023	0.0031	–	3370
	RJK0346DPA	30	65	49	0.002	0.0027	–	7650
	RJK0658DPA	60	25	19.4	0.0111	–	–	1580
WPAK(3F)	RJK2075DPA	200	20	38	0.069	–	–	2200

# Memory

# LOW POWER SRAM

## Stable supply and long-term support

- #1 Low Power SRAM supplier world wide (Source: Renesas Electronics.)
- Long life cycles ensure a steady flow of products, which gives your design longevity.

## Exclusive Core Technology, Advanced LPSRAM—Higher Reliability & Smaller Cell Size

### High Reliability

#### Latch Up Free & Soft Error Free

- Soft Error Rate – 500 times less than competitor’s 90nm products

Advanced LPSRAM cell has capacitor on each storage node. As its stored charge is very large, soft error rate is much smaller than competitor’s SRAM

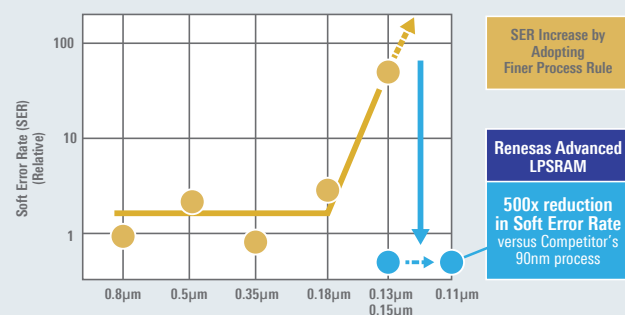

### Smaller Cell Size

- Renesas original memory cell: TFT (1) & physical capacitor (2) stacked technology

Drastically reduce memory cell to half the size of a compared to conventional full CMOS cell

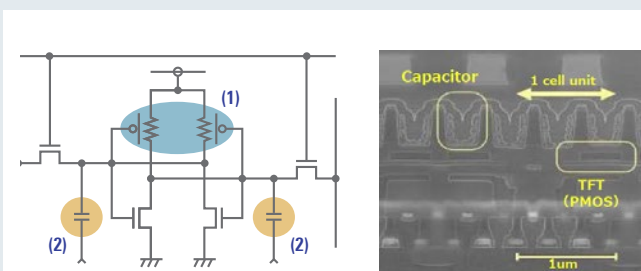

### Roadmap/Package Lineup

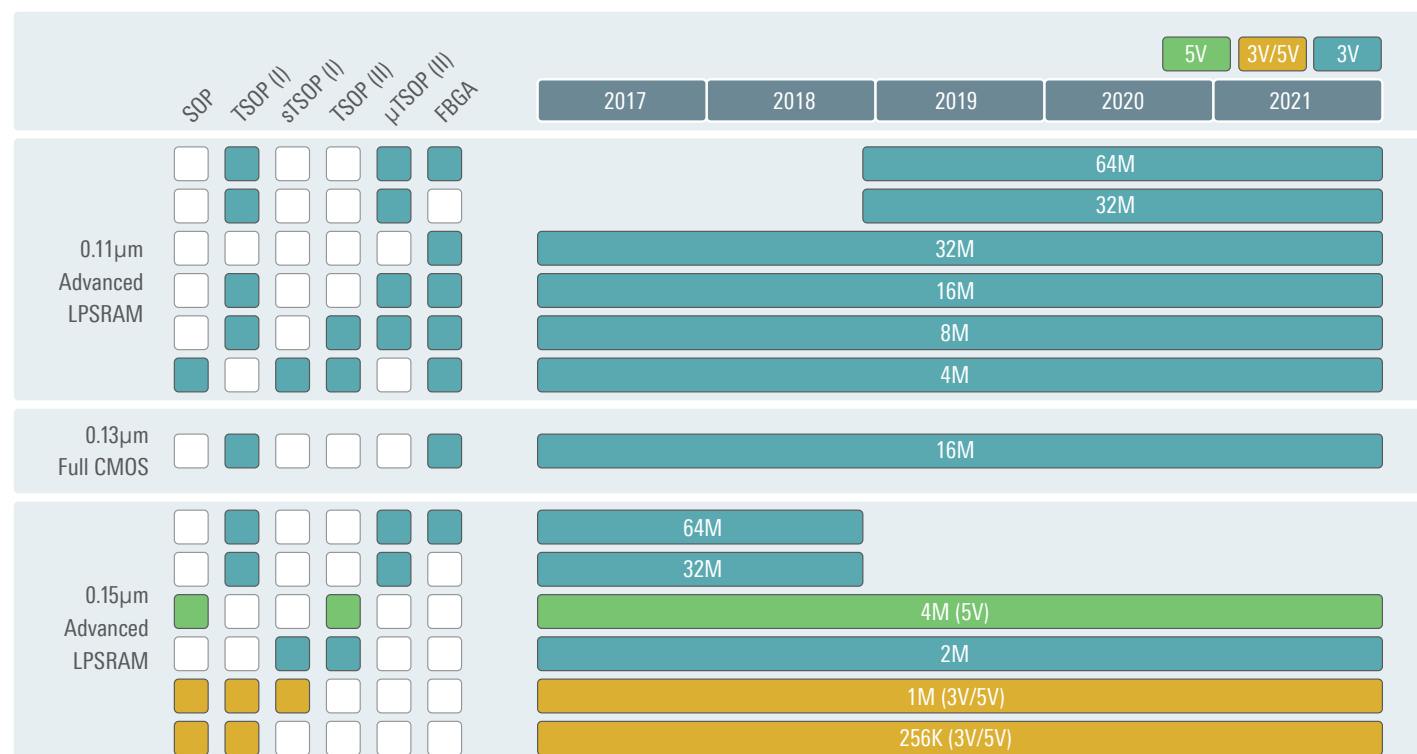

## Low Power SRAM Product Lineup

Density	Voltage	Organization	Package	Part Number	Access time		Operating Temp. (-40 to +85°C)		
					45ns	55ns			
256Kbit	4.5V to 5.5V	32K x 8	SOP (28)	R1LP5256ESP		•	•		
			TSOP (28)	R1LP5256ESA		•	•		
	2.7V to 3.6V		SOP (28)	R1LV5256ESP		•	•		
			TSOP (28)	R1LV5256ESA		•	•		
1Mbit	4.5V to 5.5V	128K x 8	SOP (32)	R1LP0108ESN		•	•		
			TSOP (32)	R1LP0108ESF		•	•		
			sTSOP (32)	R1LP0108ESA		•	•		
	2.7V to 3.6V		SOP (32)	R1LV0108ESN		•	•		
			TSOP (32)	R1LV0108ESF		•	•		
			sTSOP (32)	R1LV0108ESA		•	•		
2Mbit	2.7V to 3.6V	256K x 8	sTSOP (32)	R1LV0208BSA		•	•		
		128K x 16	TSOP (44)	R1LV0216BSB		•	•		
4Mbit	4.5V to 5.5V	512K x 8	SOP (32)	R1LP0408DSP		•	•		
			TSOP (32)	R1LP0408DSB		•	•		
			2.7V to 3.6V	SOP (32)	RMLV0408EGSP	•		•	
				TSOP (32)	RMLV0408EGSB	•		•	
	256K x 16		sTSOP (32)	RMLV0408EGSA	•		•		
			TSOP (44)	RMLV0416EGSB	•		•		
			FBGA (48)	RMLV0416EGSB	•		•		
				RMLV0416EGBG	•		•		
		8Mbit	2.7V to 3.6V	1M x 8	TSOP (44)	RMLV0808BGSB	•		•
			2.4V to 3.6V			•		•	
2.7V to 3.6V	512K x 16		TSOP (44)	RMLV0816BGSB	•		•		
			2.4V to 3.6V		•		•		
2.7V to 3.6V	512K x 16		FBGA (48)	RMLV0816BGBG	•		•		
			2.4V to 3.6V		•		•		
	2.7V to 3.6V		1M x 8/ 512K x 16	TSOP (48)	RMLV0816BGSA	•		•	
				µTSOP (52)	RMLV0816BGSD	•		•	
			2.4V to 3.6V	1M x 16/ 2M x 8	TSOP (48)	RMLV1616AGSA		•	•
					µTSOP (52)	RMLV1616AGSD	•		•
2.7V to 3.6V	1M x 16	FBGA (48)	RMLV1616AGBG		•	•			
		R1LV1616HBG	•		•				
	2.7V to 3.6V	2M x 16/ 4M x 8	TSOP (48)	R1LV3216RSA		•	•		
			µTSOP (52)	R1LV3216RSD		•	•		
2.7V to 3.6V	2M x 16	FBGA (48)	RMWV3216AGBG		•	•			
	2.7V to 3.6V	4M x 16/ 8M x 8	TSOP (48)	R1WV6416RSA		•	•		
µTSOP (52)			R1WV6416RSD		•	•			
FBGA (48)			R1WV6416RBG		•	•			



Resources

# POWERCOMPASS™ TOOL

## Simplify Your Power Design with the PowerCompass Multi-load Configurator

The PowerCompass™ tool makes product selection easy—quickly find Renesas parts that match your requirements, set up multiple rails if needed, perform high-level system analysis and generate reference design files.

- Upfront design time reduced by 92%
- Multiple solution options highlight design tradeoffs for BOM count, design size and price
- Pre-loaded design templates for popular FPGAs and microprocessors



Start Your Project Now

[www.intersil.com/powercompass](http://www.intersil.com/powercompass)

1 Define Your Power Requirements



2 Select Parts

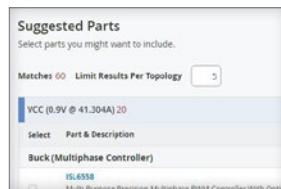

3 Summary Analysis

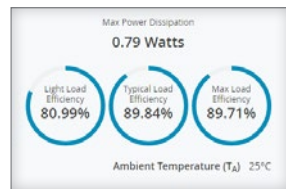

4 Generate Reference Designs

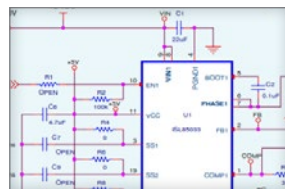

# ISIM DESIGN & SIMULATION TOOL

## Renesas Advanced Design Tool for Creating Complex Solutions in 4 Easy Steps

iSim is an easy-to-use, interactive power management and op amp design tool that allows you to quickly select supporting components, build your schematic and validate your design.

iSim™ is a powerful web-based simulation tool. This software package gives the user a web based tool for designing and simulating various circuits used in Power Management and Op Amp applications. The simulation results provide a good baseline analysis of a device's in-circuit performance.

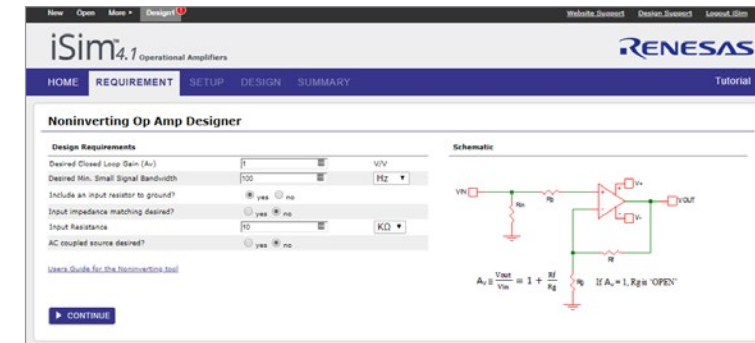

[www.intersil.com/isim](http://www.intersil.com/isim)

1 Chose your device and click "Simulate"



2 Chose an application circuit type



3 Input your design requirements

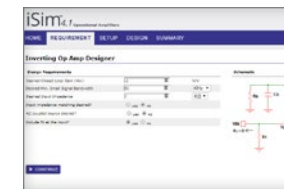

4 Configure, analyze or download schematics

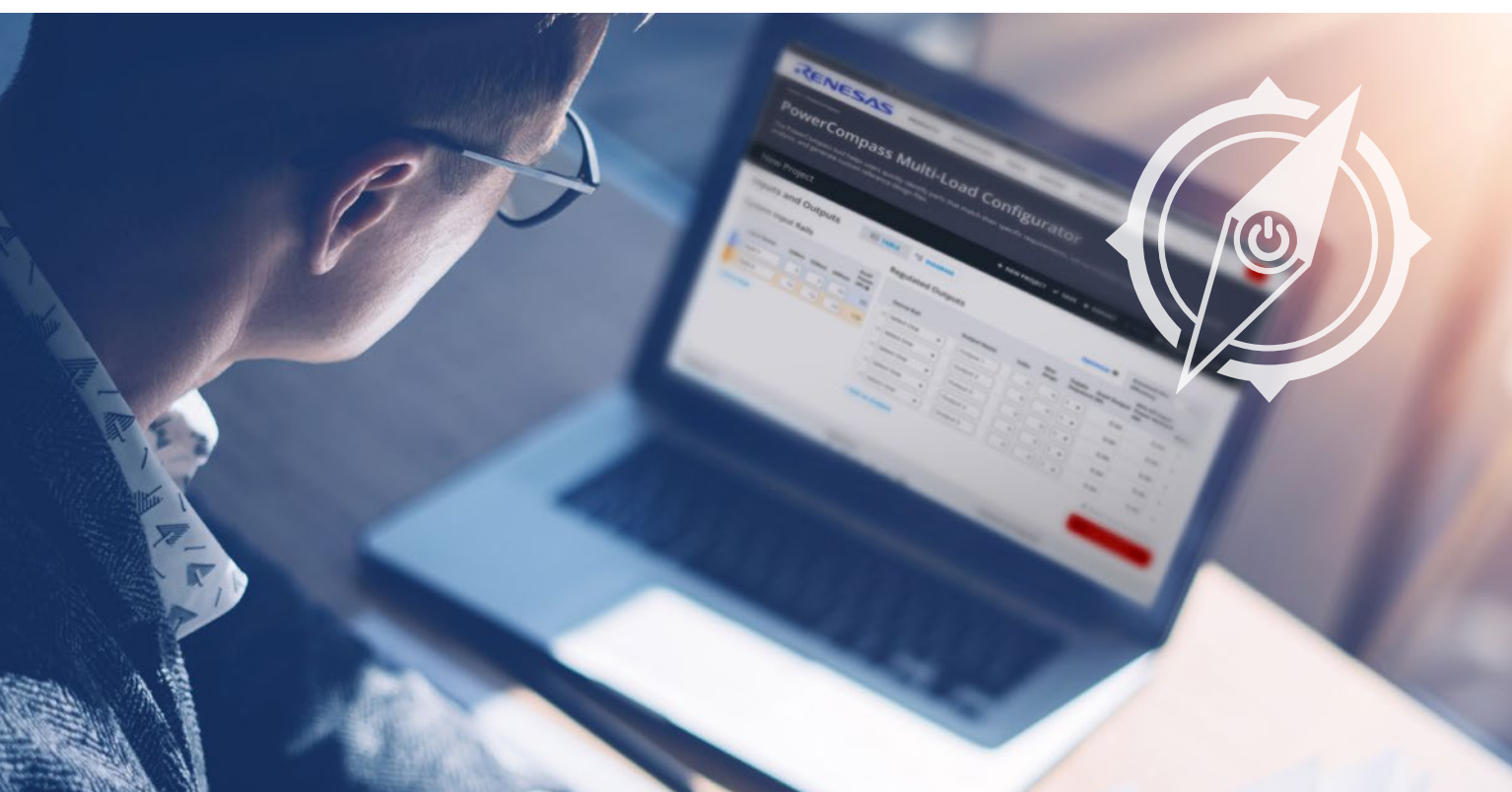
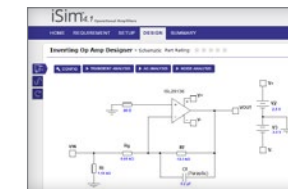

### iSim:PE Offline Simulator

[www.intersil.com/en/tools/isim.html#isimpe](http://www.intersil.com/en/tools/isim.html#isimpe)

#### Overview

iSim Personal Edition (iSim:PE) speeds the design cycle and reduces risk early in any project, identifying parts that can be used in current as well as next-generation designs.

The easy-to-use tool quickly and reliably selects devices to support increasing power densities, wide input-voltage and temperature ranges, maximum efficiency, fast transient response and other vital specifications.

Simulated designs are displayed in an online schematic and can be verified immediately. After verification, iSim generates a BOM and a comprehensive design report.

iSim:PE resides on a local PC ready for use either online or offline.

#### Features

- Quickly search, review and select MOSFETS or diodes based on design requirements
- Easily filter and sort from all available devices
- Add jumpers to easily switch between different circuit configurations
- Review efficiency graphs and power loss distribution across components

# DESIGN TOOLS AND SUPPORT

Get to Market Faster and Easier with Comprehensive Tools and Support

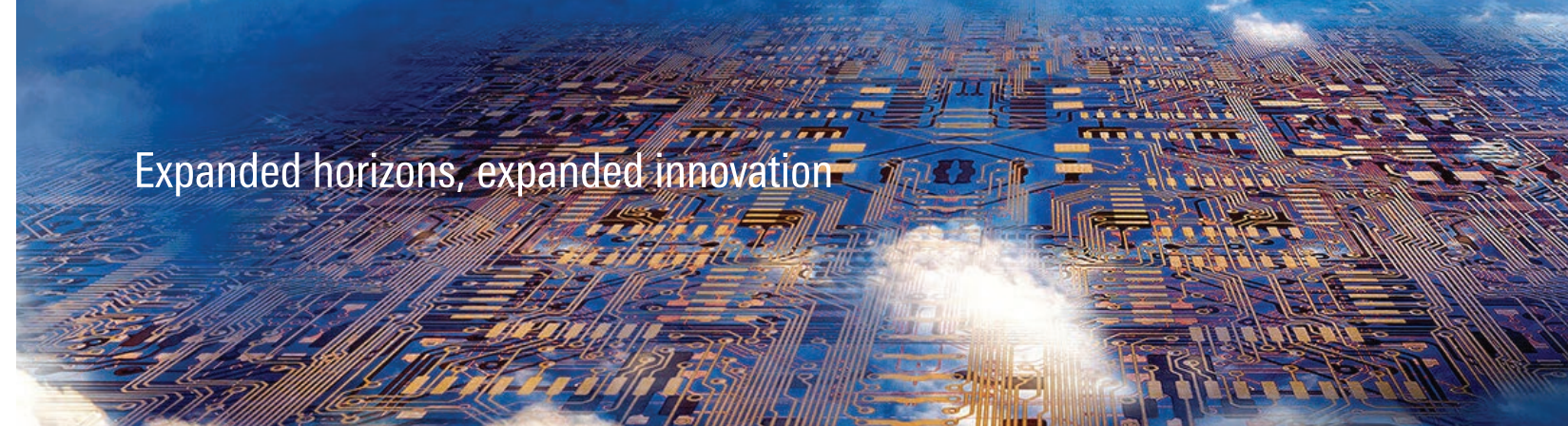

Expanded horizons, expanded innovation

## Parametric Search



Find the product you want by filtering by various specifications.

[www.renesas.com/search/parametric-search.html](http://www.renesas.com/search/parametric-search.html)

## e-learning



Learn how to use Renesas semiconductor products online. Useful for self-learning.

[academy.renesas.com](http://academy.renesas.com)

## Engineer School



Covers basic embedded-system concepts and technologies. Intended for readers considering a career in embedded engineering, and for professionals looking to fill in some gaps.

[www.renesas.com/support/technical-resources/engineer-school.html](http://www.renesas.com/support/technical-resources/engineer-school.html)

## EDA Data



Renesas Electronics prepares the EDA symbols and simulation models for the development TAT shortening. Please utilize your application development.

[www.renesas.com/support/technical-resources/eda-data.html](http://www.renesas.com/support/technical-resources/eda-data.html)

## RENESAS Lab. VP

Renesas Virtual Power Laboratory

Renesas Electronics prepares the web simulation tool for the development TAT shortening. Please utilize your application development.

[www.renesas.com/support/technical-resources/analog-simulation.html](http://www.renesas.com/support/technical-resources/analog-simulation.html)

## RenesasRulz.com

*Think it. Build it. Post it.*

A forum and community site to share technical information, questions and opinions with others who use Renesas devices.

[renesasrulz.com](http://renesasrulz.com)

Effective January 1, 2018, Renesas and Intersil are operating as one unified enterprise, bringing about a significant expansion to the intrinsic capabilities of semiconductors.

This combination unites the widely acclaimed Renesas MCU and SoC technologies with Intersil's market-leading expertise in high performance power management and precision analog devices. In turn, this brings organic growth in the automotive, industrial and broadbased sectors, allowing the new enterprise to respond with greater speed to customers' systems needs.

The union of Renesas with Intersil began with the completion of the acquisition on February 24, 2017, and the unified "One Global Renesas" went into operation across all markets the following July—bringing together the strengths of both organizations in anticipation of customer requirements in a rapidly changing market environment. This truly global organization offers a vast synergistic effect.

Join Renesas as it strengthens its leading position in the global semiconductor market.

## About Renesas

Renesas Electronics delivers trusted embedded design innovation with complete semiconductor solutions that enable billions of connected, intelligent devices to enhance the way people work and live—securely and safely.

The number one global supplier of microcontrollers, and a leader in Analog & Power and SoC products, Renesas provides the expertise, quality, and comprehensive solutions for a broad range of Automotive, Industrial, Home Electronics (HE), Office Automation (OA) and Information Communication Technology (ICT) applications to help shape a limitless future.

## Global Network

Responding rapidly to customer needs through strong global operations.

[www.renesas.com/ecosystem](http://www.renesas.com/ecosystem)

## Renesas Main Offices

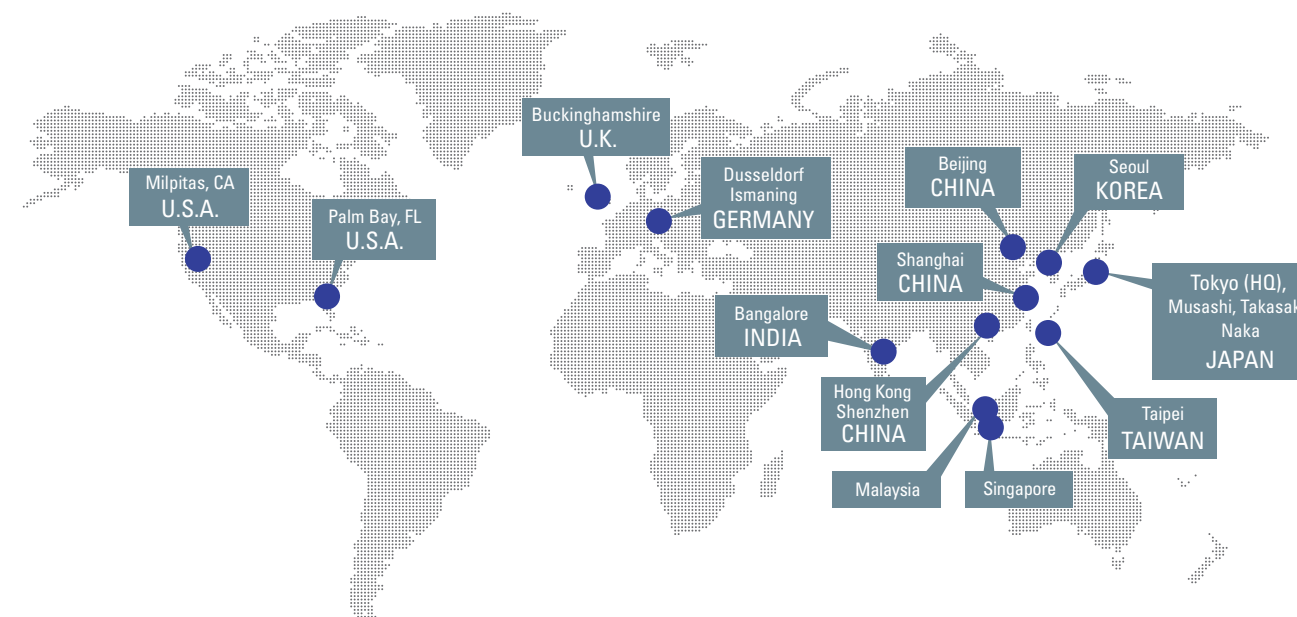

## Notice

1. Descriptions of circuits, software and other related information in this document are provided only to illustrate the operation of semiconductor products and application examples. You are fully responsible for the incorporation or any other use of the circuits, software, and information in the design of your product or system. Renesas Electronics disclaims any and all liability for any losses and damages incurred by you or third parties arising from the use of these circuits, software, or information.
  2. Renesas Electronics hereby expressly disclaims any warranties against and liability for infringement or any other claims involving patents, copyrights, or other intellectual property rights of third parties, by or arising from the use of Renesas Electronics products or technical information described in this document, including but not limited to, the product data, drawings, charts, programs, algorithms, and application examples.
  3. No license, express, implied or otherwise, is granted hereby under any patents, copyrights or other intellectual property rights of Renesas Electronics or others.
  4. You shall not alter, modify, copy, or reverse engineer any Renesas Electronics product, whether in whole or in part. Renesas Electronics disclaims any and all liability for any losses or damages incurred by you or third parties arising from such alteration, modification, copying or reverse engineering.
  5. Renesas Electronics products are classified according to the following two quality grades: "Standard" and "High Quality". The intended applications for each Renesas Electronics product depends on the product's quality grade, as indicated below.  
 "Standard": Computers; office equipment; communications equipment; test and measurement equipment; audio and visual equipment; home electronic appliances; machine tools; personal electronic equipment; industrial robots; etc.  
 "High Quality": Transportation equipment (automobiles, trains, ships, etc.); traffic control (traffic lights); large-scale communication equipment; key financial terminal systems; safety control equipment; etc.  
 Unless expressly designated as a high reliability product or a product for harsh environments in a Renesas Electronics data sheet or other Renesas Electronics document, Renesas Electronics products are not intended or authorized for use in products or systems that may pose a direct threat to human life or bodily injury (artificial life support devices or systems; surgical implantations; etc.), or may cause serious property damage (space system; undersea repeaters; nuclear power control systems; aircraft control systems; key plant systems; military equipment; etc.). Renesas Electronics disclaims any and all liability for any damages or losses incurred by you or any third parties arising from the use of any Renesas Electronics product that is inconsistent with any Renesas Electronics data sheet, user's manual or other Renesas Electronics document.
  6. When using Renesas Electronics products, refer to the latest product information (data sheets, user's manuals, application notes, "General Notes for Handling and Using Semiconductor Devices" in the reliability handbook, etc.), and ensure that usage conditions are within the ranges specified by Renesas Electronics with respect to maximum ratings, operating power supply voltage range, heat dissipation characteristics, installation, etc. Renesas Electronics disclaims any and all liability for any malfunctions, failure or accident arising out of the use of Renesas Electronics products outside of such specified ranges.
  7. Although Renesas Electronics endeavors to improve the quality and reliability of Renesas Electronics products, semiconductor products have specific characteristics, such as the occurrence of failure at a certain rate and malfunctions under certain use conditions. Unless designated as a high reliability product or a product for harsh environments in a Renesas Electronics data sheet or other Renesas Electronics document, Renesas Electronics products are not subject to radiation resistance design. You are responsible for implementing safety measures to guard against the possibility of bodily injury, injury or damage caused by fire, and/or danger to the public in the event of a failure or malfunction of Renesas Electronics products, such as safety design for hardware and software, including but not limited to redundancy, fire control and malfunction prevention, appropriate treatment for aging degradation or any other appropriate measures. Because the evaluation of microcomputer software alone is very difficult and impractical, you are responsible for evaluating the safety of the final products or systems manufactured by you.
  8. Please contact a Renesas Electronics sales office for details as to environmental matters such as the environmental compatibility of each Renesas Electronics product. You are responsible for carefully and sufficiently investigating applicable laws and regulations that regulate the inclusion or use of controlled substances, including without limitation, the EU RoHS Directive, and using Renesas Electronics products in compliance with all these applicable laws and regulations. Renesas Electronics disclaims any and all liability for damages or losses occurring as a result of your noncompliance with applicable laws and regulations.
  9. Renesas Electronics products and technologies shall not be used for or incorporated into any products or systems whose manufacture, use, or sale is prohibited under any applicable domestic or foreign laws or regulations. You shall comply with any applicable export control laws and regulations promulgated and administered by the governments of any countries asserting jurisdiction over the parties or transactions.
  10. It is the responsibility of the buyer or distributor of Renesas Electronics products, or any other party who distributes, disposes of, or otherwise sells or transfers the product to a third party, to notify such third party in advance of the contents and conditions set forth in this document.
  11. This document shall not be reprinted, reproduced or duplicated in any form, in whole or in part, without prior written consent of Renesas Electronics.
  12. Please contact a Renesas Electronics sales office if you have any questions regarding the information contained in this document or Renesas Electronics products.
- (Note 1) "Renesas Electronics" as used in this document means Renesas Electronics Corporation and also includes its directly or indirectly controlled subsidiaries.  
 (Note 2) "Renesas Electronics product(s)" means any product developed or manufactured by or for Renesas Electronics.

(Rev.4.0-1 November 2017)

## SALES OFFICES

Refer to "http://www.renesas.com/" for the latest and detailed information.

### Renesas Electronics America Inc.

1001 Murphy Ranch Road, Milpitas, CA 95035, U.S.A.  
Tel: +1-408-432-8888, Fax: +1-408-434-5351

### Renesas Electronics Canada Limited

9251 Yonge Street, Suite 8309 Richmond Hill, Ontario Canada L4C 9T3  
Tel: +1-905-237-2004

### Renesas Electronics Europe Limited

Dukes Meadow, Millboard Road, Bourne End, Buckinghamshire, SL8 5FH, U.K  
Tel: +44-1628-651-700, Fax: +44-1628-651-804

### Renesas Electronics Europe GmbH

Arcadiastrasse 10, 40472 Düsseldorf, Germany  
Tel: +49-211-6503-0, Fax: +49-211-6503-1327

### Renesas Electronics (China) Co., Ltd.

Room 1709 Quantum Plaza, No.27 ZhichunLu, Haidian District, Beijing, 100191 P. R. China  
Tel: +86-10-8235-1155, Fax: +86-10-8235-7679

### Renesas Electronics (Shanghai) Co., Ltd.

Unit 301, Tower A, Central Towers, 555 Langao Road, Putuo District, Shanghai, 200333 P. R. China  
Tel: +86-21-2226-0888, Fax: +86-21-2226-0999

### Renesas Electronics Hong Kong Limited

Unit 1601-1611, 16/F., Tower 2, Grand Century Place, 193 Prince Edward Road West, Mongkok, Kowloon, Hong Kong  
Tel: +852-2265-6688, Fax: +852 2886-9022

### Renesas Electronics Taiwan Co., Ltd.

13F, No. 363, Fu Shing North Road, Taipei 10543, Taiwan  
Tel: +886-2-8175-9600, Fax: +886 2-8175-9670

### Renesas Electronics Singapore Pte. Ltd.

80 Bendemeer Road, Unit #06-02 Hyflux Innovation Centre, Singapore 339949  
Tel: +65-6213-0200, Fax: +65-6213-0300

### Renesas Electronics Malaysia Sdn.Bhd.

Unit 1207, Block B, Menara Amcorp, Amcorp Trade Centre, No. 18, Jln Persiaran Barat, 46050 Petaling Jaya, Selangor Darul Ehsan, Malaysia  
Tel: +60-3-7955-9390, Fax: +60-3-7955-9510

### Renesas Electronics India Pvt. Ltd.

No.777C, 100 Feet Road, HAL 2nd Stage, Indiranagar, Bangalore 560 038, India  
Tel: +91-90-67208700, Fax: +91-90-67208777

### Renesas Electronics Korea Co., Ltd.

17F, KAMCO Yangjae Tower, 262, Gangnam-daero, Gangnam-gu, Seoul, 06265 Korea  
Tel: +82-2-558-3737, Fax: +82-2-558-5338