

---

## Vtrim and Paralleling

---

**Abstract:** This application note describes the process for paralleling the Xgen and Ultimod powerMod outputs in order to increase output current when using the onboard potentiometers or a dynamic Vtrim signal to set the output voltage. Please note that only powerMods of the same type should be paralleled.

### Definitions

- Front end of chassis: This is defined as the same side that the AC mains power is applied to connector J1.
- Back end of chassis: This is defined as the opposite side to that of the front end of the chassis.
- Underside of chassis: This is defined as the base of the chassis where the output module mounting screws are located.

### Equipment

- Screwdriver: Philips Size 1 or equivalent.
- Pot Trimmer Screwdriver.
- Multimeter
- XP1 Parallel Link Connection Bars.
- If Paralleling XgA-XgD - LK1 Jumper – Harwin M7567-05 (Jumper Socket, 2.54 mm, 2-Way)



**Figure 1. Equipment Needed**

### Current share by droop

The Xgen and Ultimod power supplies utilize the droop current share method for load sharing. It does this by using a current feedback signal which is added into the main feedback loop of the converter. This current feedback ‘softens’ the modules voltage regulation, i.e. as output current increases, output voltage decreases. If one *powerMod* is delivering more current than another *powerMod* that it is paralleled with, its output voltage will be adjusted down a little so that both paralleled *powerMods* will be delivering equal current.

### The Circuit

There is a current resistor ( $R_{sense}$ ) on the return path of each *powerMod*. The voltage drop across this resistor is fed into a differential amplifier resulting in a voltage representation of the current that each module is supplying.

When the Ishare switch (see Figure 2) is closed this signal voltage is fed into the main feedback loop. This will decrease the DC gain of the control loop which will decrease the load regulation of the individual *powerMOD*.

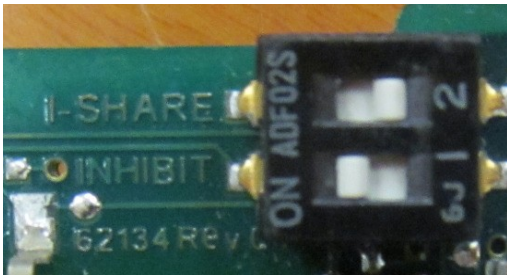
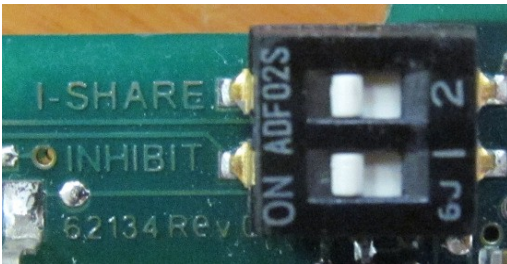
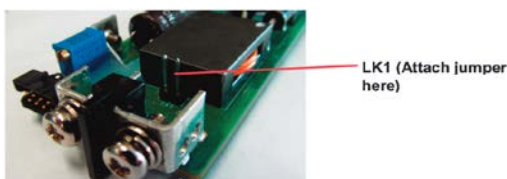
This ensures that we see the load current is evenly shared between the adjacent modules. It is important to note that the effectiveness of current sharing will be proportional to the  $dV$  on set up (the voltage difference between the initial output voltage settings of the *powerMods*).

Section 1 below describes the process for setting the voltages on paralleled modules when the voltages will remain static throughout the operation of the power supply. The Xgen and Ultimod have the added feature in that paralleled units can have their voltages adjusted on the fly using the Vtrim pin. Section 2 will provide details on how to setup the units for this mode of operation.

**Section 1: Procedure for Paralleling , Set & Forget.**

When connecting *powerMODs* in parallel, the following steps should be followed to maximize the effectiveness of current sharing:

1. Ensure that the *powerMOD* current share is turned ON. For modules Xg1-Xg5 and XgG-XgT this is done by turning the I-Share DIP switch on each *powerMod* to I-Share ON. In the case of XgA-XgD modules this is done by installing jumper LK1 (there is no switch).

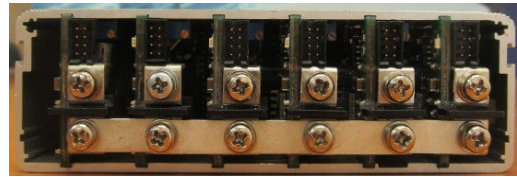

**Figure 2 I-Share OFF**

**Figure 3 I-Share On**

**Figure 4 LK1 Location**

2. Insert *powerMods* into the back end of the chassis.

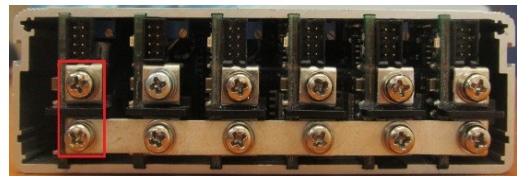

**Figure 5 Xgen/Ultimod Modules**

3. Attach the negative Parallel Links (XP1) to all

modules being paralleled.


**Figure 6 Xgen/Ultimod with Negative Links**

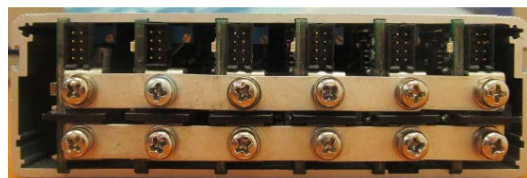
4. Set the voltage of *powerMod* 1 to the output voltage required using whatever method will be used in the final application – onboard potentiometer, static Vtrim voltage signal of Vtrim resistance. (see **Section 1A** if using sense lines and **Section 1B** if configuring XgR or XgT modules).


**Figure 7 Set powerMod 1 Voltage**

5. One by one, measure the voltage difference (dV) between the positive terminals of the *powerMod* 1 and the remaining *powerMods* and adjust them to minimise dV using their onboard potentiometers (typically to within 5 mV).


**Figure 8 Minimise dV for powerMods**

6. Attach the positive parallel links.


**Figure 9 Xgen/Ultimod with Positive and Negative Links**

The percentage of current sharing can be calculated as follows:

$$\text{I-Share error \%} = 10000\text{dV} / 1.5 \text{ Vmax}$$

**Section 1A: When Using Sense Lines (Xg1-5 and XgG-Q)**

Remote Sensing is used in order to ensure that voltage regulation is carried out at the point of load as opposed to the output of the supply, thereby compensating for any voltage drop in power leads. If Remote Sensing is used in the final application, output voltages should be set at the Sense pins (J3Pin1 +Sense, J3Pin2 –Sense) as this is the point of regulation.

The paralleling process for this setup is much the same, follow steps 1-6 above with two slight changes:

- In Step 4 set the output voltage at the Sense pins as opposed to the output pins.
- In Step 5 measure  $dV$  between the J3Pin1 + Sense pins as opposed to the output pins.

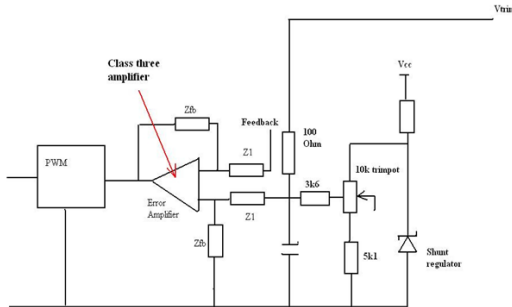
Remote Sense can be implemented as with a single *powerMod*. Simply connect the sense pins of the paralleled *powerMods* together and bring the sense connections from one of the *powermods* to the load.

**Section 1B: Paralleling XgR and XgT Modules**

XgR & XgT modules which have an on board Or'ing isolation circuit for protection which is not turned on at no load. In order to turn on this circuit during the paralleling process it is necessary to load the modules with at least 100 mA when setting the output voltage. A simple resistor can be used for this load during the measurement and adjustment steps of the paralleling procedure.

**Section 2: Paralleling while utilizing a Dynamic Vtrim (Xg1-5 and XgG-T)**

When a common Vtrim signal is applied to two different modules, their output voltages will be slightly different due to the tolerances of the components used in the Vtrim circuitry. These components are outlined in Fig 10 below.

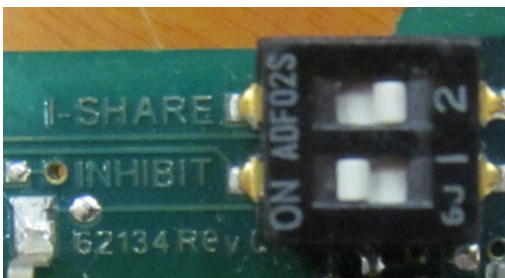


**Figure 10 Vtrim**

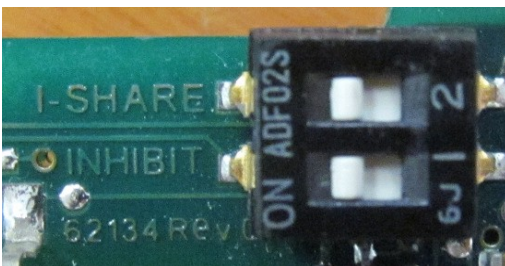
This additional dV will reduce the current share effectiveness. However, if we use the following configuration procedure we can compensate for these component tolerances (even when using a dynamic Vtrim signal).

Determine the dynamic trim range of the Vtrim signal that will be used in the application. We will then optimise for the midpoint, i.e. for a 12 V to 24 V output, we will optimise for 18 V.

1. Ensure that the powerMod DIP switches on each powerMod is switched to I-Share ON.

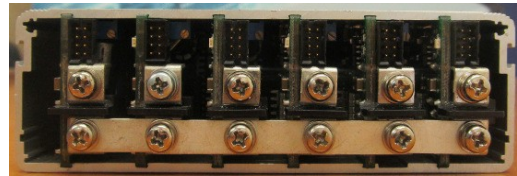


**Figure 11 I-Share Off**



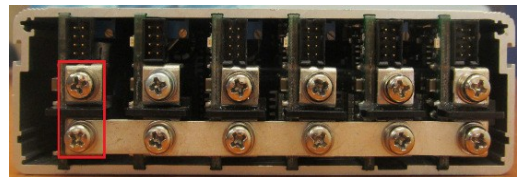
**Figure 12 I-Share On**

2. Insert *powerMods* in the back end of the chassis. Trim all modules to their nominal voltage outputs using the onboard potentiometers.



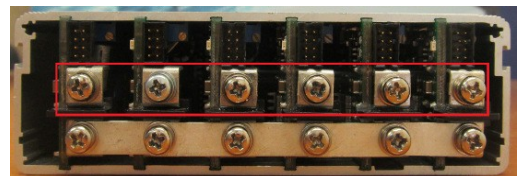
**Figure 13 Xgen/Ultimod with Negative Links**

3. Apply a Vtrim signal (either voltage or resistance) to all *powerMods* being paralleled. This should be from a single source (i.e. all Vtrim pins of paralleled powerMods are connected together, all – Sense pins of paralleled powerMods are connected together). See the designers' manual if more information on the Vtrim process is required.
4. Adjust the applied Vtrim signal until the output voltage (or voltage between the Sense Pins if using Remote Sense) of powerMod 1 is the midpoint voltage determined in step 1.



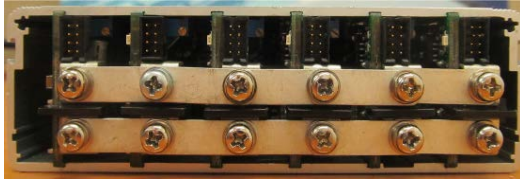
**Figure 14 Set powerMod 1 Voltage**

5. One by one, measure the voltage difference (dV) between the positive terminals (or +Sense pins if using Remote Sense) of the *powerMod* 1 and the remaining *powerMods* and adjust them using their onboard potentiometers to minimise dV.(typically to within 5 mV).



**Figure 15 Minimise dV for powerMods**

6. Attach the positive parallel links. Once the positive links have been attached, Do Not remove the Vtrim connections. Without the Vtrim connection the modules may be trimmed to very different voltages, and so should not be paralleled.



**Figure 16 Xgen/Ultimod with Positive and Negative Links**

If the above process is used, the Xgen and Ultimod will have good current sharing at the midpoint of operation, and very good optimization across the range of dynamic trim operation.

#### *About Advanced Energy*

*Advanced Energy (AE) has devoted more than three decades to perfecting power for its global customers. AE designs and manufactures highly engineered, precision power conversion, measurement and control solutions for mission-critical applications and processes.*

*AE's power solutions enable customer innovation in complex semiconductor and industrial thin film plasma manufacturing processes, demanding high and low voltage applications, and temperature-critical thermal processes.*

*With deep applications know-how and responsive service and support across the globe, AE builds collaborative partnerships to meet rapid technological developments, propel growth for its customers and power the future of technology.*

*For further information on our products, please visit [www.advancedenergy.com](http://www.advancedenergy.com).*