

AFBR-S50MV68B

Time-of-Flight Sensor Module for Distance and Motion Measurement

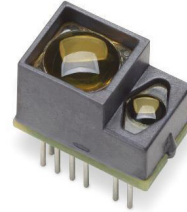

Description

The Broadcom[®] AFBR-S50MV68B is a multi-pixel optical distance and motion measurement sensor module based on the optical Time-of-Flight principle. The technology has been developed with a special focus on applications with the need for highest speed and accuracy at medium distance ranges, with small size and very low power consumption.

Due to its ambient light suppression, use in outside environments is possible in sunlight. The sensor accurately measures against white, black, and colored surfaces as well as metallic and retroreflective surfaces.

The module has an integrated laser light source and an internal clock source. A single power supply of 5.0V is required. Data is transferred using a digital Serial Peripheral Interface (SPI) using standard 3.3V CMOS levels. For system health monitoring, a reference pixel is used in addition to the integrated voltage and temperature sensors.

Frame rates of up to 3 kHz are supported, depending on the microcontroller, the data streaming mode, and the number of evaluated pixels. For frame rates of up to 100 Hz, a dual-frequency (2f) mode is used to achieve an unambiguous range of up to 100m.

Specifications

- Single voltage supply of 5V
- Typical current consumption of 33 mA
- Integrated 680-nm red laser source
- Typical optical peak output power of 20 mW
- Typical optical average output power < 0.35 mW
- Receiver with 32 pixels
- Field of view per pixel of 1.55° × 1.55°
- Transmitter beam width of 0.4° × 0.4° to illuminate typically 1 pixel
- Distance range up to 10m and beyond
- Operation temperature (ambient): -20°C to 50°C
- SPI digital interface up to 25 MHz
- Size without pins: L × W × H: 12.4 mm × 7.6 mm × 7.9 mm

Features

- Very fast measurement rates of up to 3 kHz
- Operation up to 100 klx
- Integrated calibrated clock source
- Accuracy error typically below ± 1%
- Unambiguous range up to 100m in 2f mode
- Reference pixel for system health monitoring
- Laser Class 1 eye safe ready

Applications

- Distance measurement
- Human machine interfaces
- Robotics
- Automation and control
- Inventory monitoring
- Light barrier

Mechanical Dimensions

Figure 1: Module Side and Top View, Dimensions in mm

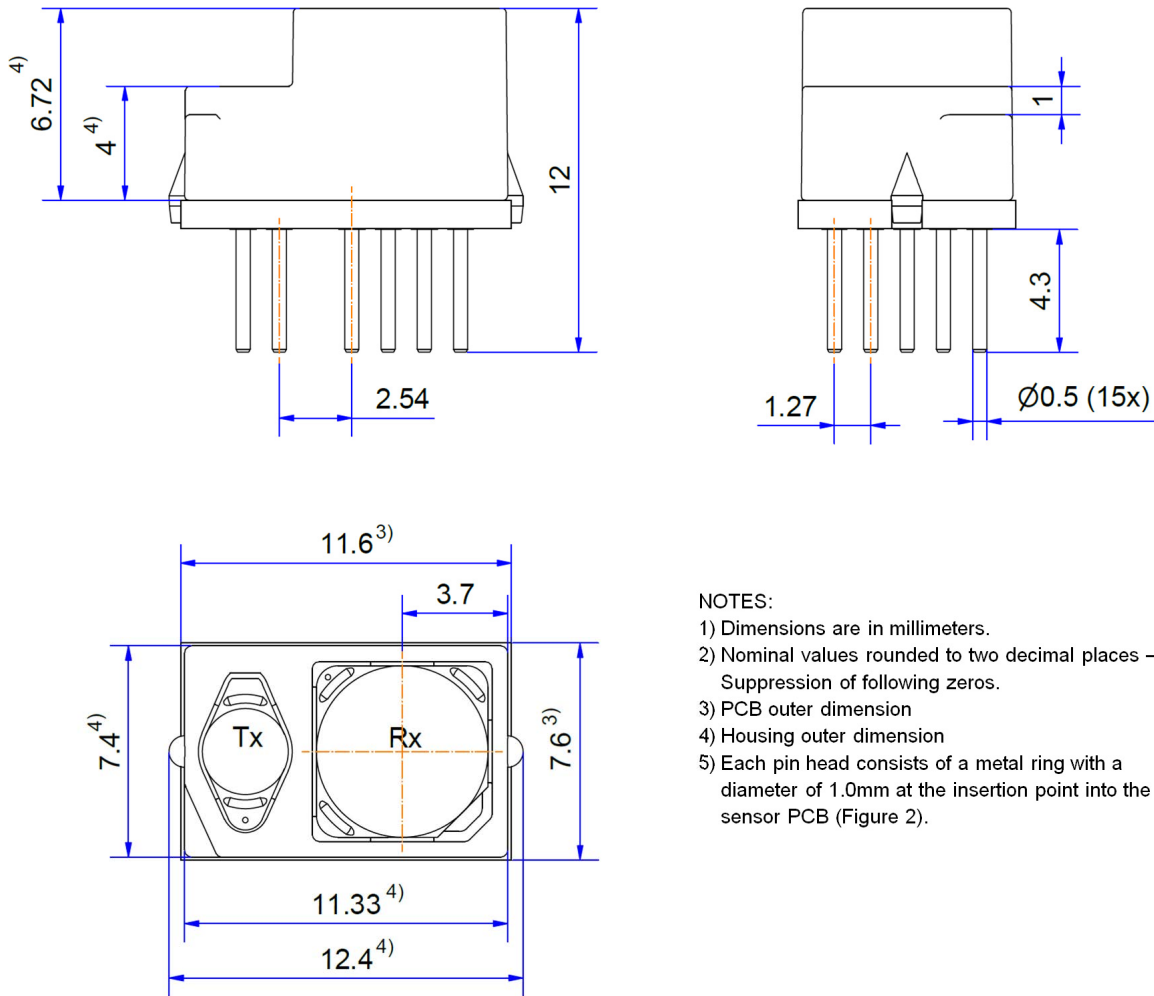

NOTES:

- 1) Dimensions are in millimeters.
- 2) Nominal values rounded to two decimal places – Suppression of following zeros.
- 3) PCB outer dimension
- 4) Housing outer dimension
- 5) Each pin head consists of a metal ring with a diameter of 1.0mm at the insertion point into the sensor PCB (Figure 2).

Figure 2: Module Bottom View, Dimensions in mm

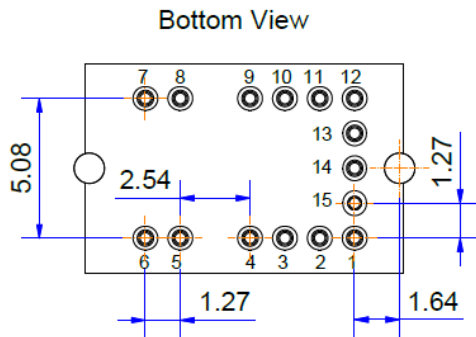

Functional Description

The integrated Time-of-Flight (ToF) sensor module is equipped with an 680-nm vertical-cavity surface-emitting laser (VCSEL) for visible red illumination. The integrated lens for the receiver has a clear aperture of 6 mm in diameter and a field-of-view (FoV) of 1.55° per pixel.

Figure 3: Block Diagram of AFBR-S50MV68B

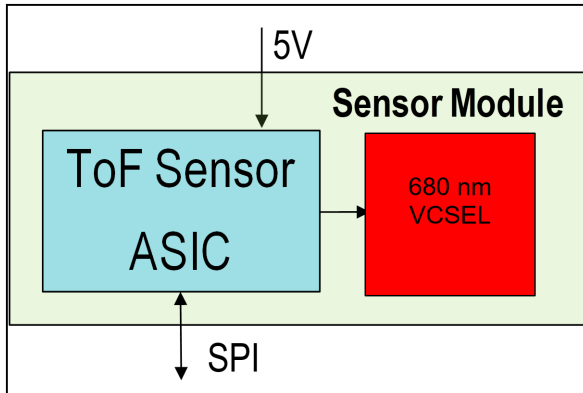

The transmitter is aligned with the receiver to illuminate typically 1 to 2 pixels simultaneously, depending on distance and reflectivity of the target object as well as the settings of the software pixel binning algorithm. In addition, the system compensates for parallax errors for very near distances. This allows the module to achieve a good pixel intensity for distance measurements over the whole measurement range, as well as deliver context information for the system. Context information includes motion, speed, tilt angles, or lateral alignment precision for small targets or features.

The maximum distance range for detecting targets with a minimum remission of 30% is up to 10m within an indoor environment. For harsh outdoor conditions under bright sunlight (for example, 50 klx with a typical midday sunlight spectrum AM 1.5), the maximum distance range for detecting targets with a minimum remission of 30% is reduced to less than 10m. If dual-frequency mode is enabled, the useful distance substantially exceeds 10m for bright or highly reflective targets. This mode is supported for frame rates up to 100 Hz.

There is no processor with firmware on the module, so all hardware configuration, calibration, and measurement steps are being performed by an external microcontroller using the ToF driver software, which extracts both distance and amplitude values of all used pixels on a per-frame base. The ToF driver software is available as a library, which is independent of the underlying hardware platform within the Arm Cortex-M family. Example software applications, such as extraction and graphical display of distance and direction, are provided with the software development kit (SDK).

The ready-to-run binaries of the ToF driver software, including an application programmer interface (API) that allows the user to configure and customize the device operation, are provided free-of-charge under a generic end user license agreement. Additionally, a reference implementation using the ToF driver software binaries through an Arm Cortex M0/M0+, M1, M3, and M4 32-bit platform is provided with an open source SDK under the GNU GPL license for evaluation and reference purposes. For detailed instructions how to install and run the kit, refer to the getting started document.

The module uses an integrated factory-calibrated and temperature-compensated RC oscillator as well as an all-digital PLL for highly precise clock generation.

The module is factory calibrated. In certain applications (for example, cover glass), an additional customer calibration is required. A suitable compensation and calibration functionality is provided along with the software driver and application software package.

Description of the Time-of-Flight Sensor ASIC and Detector Matrix

The ToF sensor ASIC includes all of the required building blocks for clock and supply generation out of a single supplied voltage, analog, and digital signal processing as well as a laser driver. The receiver sensor consists of 32 pixels, partitioned into eight rows and four lines with a hexagonal structure. The ToF drive stage allows both driving laser light sources with variable threshold and modulation currents and LEDs for up to 55-mA peak current, depending on module configuration.

Figure 4: Functional Block Diagram of Sensor ASIC within AFBR-S50MV68B

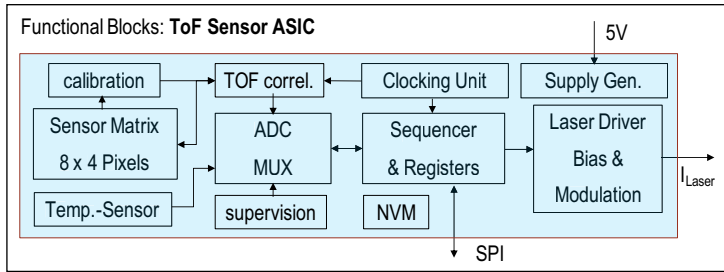

Figure 5: Hexagonal Structure of Sensor Matrix, Dimensions in μm

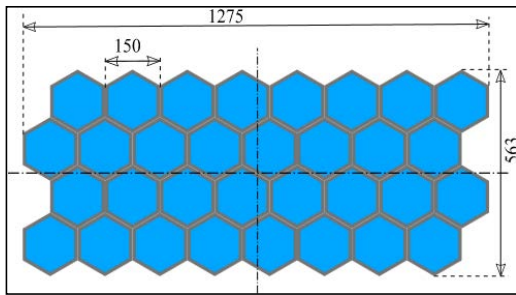
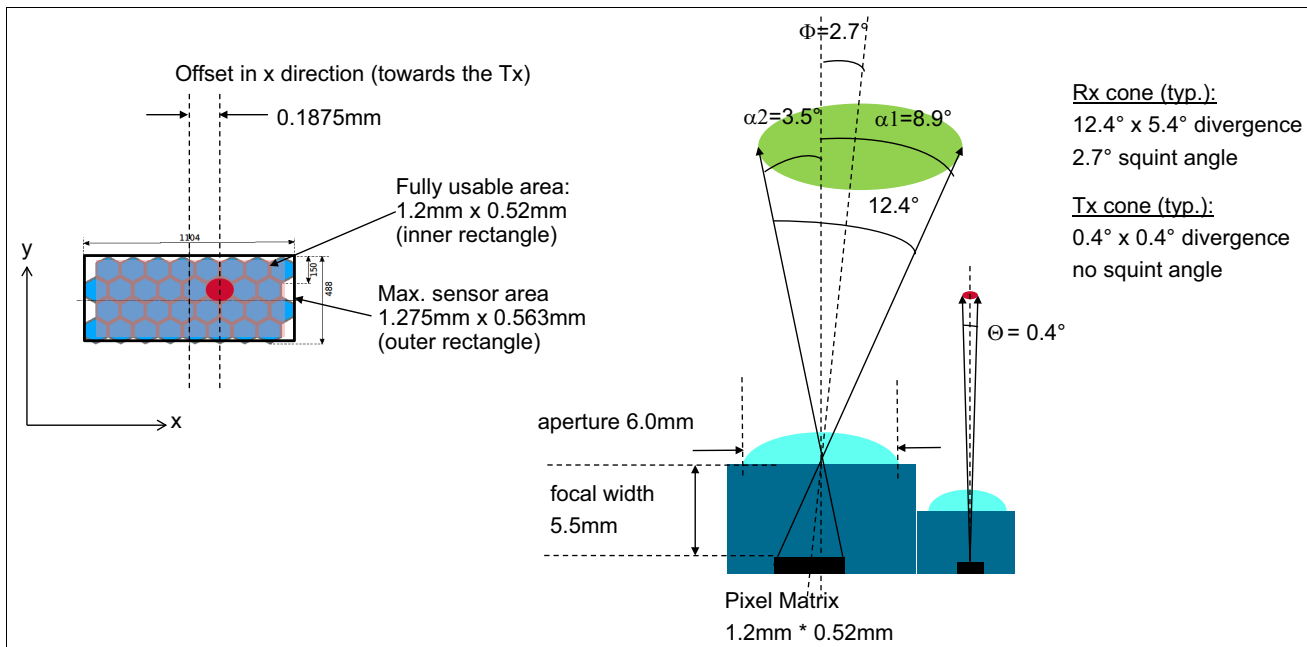

Figure 6: Field-of-View (FoV) Description of the Sensor



Detailed Module Pin Description and Operation

The housing/device includes 4.3-mm long pins with a 1.0-mm-wide conductive ring at its head and is designed for wave soldering. Reflow soldering is not allowed. Shortcuts with the conductive ring at pin head must be avoided. Because the housing is not hermetic and uses venting holes for pressure balance, no wash or flux clean is allowed. Operation in humid, noncondensing environments is possible; see [Table 4](#).

The housing provides a robust mechanical, thermal, and electrical connection to the customer PCB. The module uses a 5.0V supply, which is split up into a laser and a sensor supply rail. Separate local blocking and filtering is recommended to avoid electrical crosstalk from the laser into the sensor supply. All data sheet performance values are based on the internal clock source only.

Table 1: I/O Pin Configuration

Pin Number	Name	Pin Type	Buffer Type	Description
1	SPI_CLK	I	3.3V CMOS	SPI Clock Input for SPI interface clock up to 25 MHz using standard 3.3V CMOS levels.
2	SPI_MOSI	I	3.3V CMOS	SPI Slave Data Input using standard 3.3V CMOS levels.
3	SPI_MISO	O	3.3V, PP	SPI Slave Data Output (Push-Pull) using standard 3.3V CMOS levels with a drive strength of 8 mA.
4	IRQ_n	O	3.3V, OD	Active Low Interrupt Output (Open Drain). Measurement-ready output (Open Drain), using standard 3.3V CMOS levels with a drive strength of 4 mA with an internal pull-up of 50 k Ω . An external pull-up to 3.3V using a 10 k Ω resistor is recommended.
5	GNDL	GND	—	Laser Driver Ground, connect with Sensor GND on the PCB.
6	VDDL	PWR	—	Laser Anode Supply, connect with a Ferrite Bead to 5V and buffer with 10 μ F/100 nF versus GNDL.
7	GND	GND	—	Sensor Ground, connect to a GND plane on the PCB.
8	VDD	PWR	—	Sensor Supply, connect to 5V and buffer with 10 μ F/100 nF versus GND.
9	GND	GND	—	Sensor Ground, connect to a GND plane on the PCB.
10	CLK+	I/O	3.3V/LVDS	Optional: Clock input/output, single-ended/differential. Reference clock output; do not connect if not used; differential or single-ended.
11	CLK-	I/O	LVDS	Optional Clock input/output, differential. Reference clock output; do not connect if not used; differential only.
12	Test	NU	—	Test pin for factory usage, do not connect.
13	VDD	PWR	—	Sensor Supply, connect to 5V and buffer with 10 μ F/100 nF versus GND.
14	GND	GND	—	Sensor Ground, connect to a GND plane on the PCB.
15	SPI_CS_n	I	3.3V CMOS	SPI Chip Select (active-low) using standard 3.3V CMOS levels, internal pull up of 50 k Ω .

Absolute Maximum Ratings and Regulatory Compliance

Stresses in excess of the absolute maximum ratings can cause catastrophic damage to the device. Limits apply to each parameter in isolation, all other parameters having values within the recommended operation conditions. Exposure to the absolute maximum ratings can adversely affect device reliability.

Table 2: Absolute Maximum Ratings

Description	Symbol	Min.	Typ.	Max.	Units	Notes
Supply Voltage Sensor	VDD	-0.5	—	5.5	V	—
Supply Voltage Laser	VDDL	-0.5	—	VDD + 0.5V	V	a
Storage Temperature Range	T _{stor}	-40	—	95	°C	—
Maximum Operating Temperature Range	T _{amb}	-20	—	50	°C	b
Lead Soldering Temperature	T _{sold}	—	—	260	°C	c
Lead Soldering Time	t _{sold}	—	—	10	s	c
ESD Protection, Human Body Model	ESD_HBM	-1500	—	1500	V	d
Ambient Light Illuminance at Starting, Powering Up, and Resetting of the Device	Ev	—	—	50	klx	e

- During powering up, VDDL as well as all other signal pins must not exceed VDD by more than 0.5V.
- Operating the product outside the maximum rated ambient operating temperature range will compromise its reliability and may damage the product. Ambient air temperature is defined as the temperature measured with the thermocouple placed close to the sensor.
- The module is Pb-free wave solderable (no clean): JESD22-B106D. The moisture sensitivity level is 3.
- Human Body Model (HBM): JEDEC JS-001-2012.
- 50 klx (Spectrum AM 1.5) measured on a 90% remission target.

Table 3: Regulatory Compliance

Feature	Test Method	Performance and Comments
Electrostatic Discharge (ESD) to the Electrical Pins	JEDEC JS-001-2012	Withstands up to 1500V HBM applied between electrical pins.
RoHS I and II Compliance	RoHS Directive 2011/65EU Annex II	—
REACH Compliance	EC No 1907/2006	—
UL-94 Flammability	UL-94V-0	—
Laser Safety	Tested according to the following standards: EN 61010-1:2010 EN 60825-1:2014 EN 06825-2:2004+A1+A2	Class 1 ^a

- Laser Class 1 operation depends on correct system integration and configuration of software. Without the correct configuration or before the integration has been completed, the module can emit at higher levels and has to be rated as Laser Class 3B device.

Figure 7: Laser Safety Warning Sign for Unrecommended/Non-Default Operation



Operating Conditions and Electrical Characteristics

Table 4: Recommended Operating Conditions

Description	Symbol	Min.	Typ.	Max.	Units	Notes
Supply Voltage Sensor	VDD	4.5	5	5.5	V	a
Supply Voltage Laser (Anode)	VDDL	4.5	5	5.5	V	a
Maximum Ripple of Supply Voltage Sensor	VPP	—	—	100	mVpp	b
Maximum Ripple of Supply Voltage Laser	VPPL	—	—	100	mVpp	b
Operation Temperature Range	T _{amb}	-20	25	50	°C	—
Relative Humidity, Non-Condensing	RH	—	—	85	%	—

a. For operation over full temperature range and best performance, it is recommended to limit the range to 4.75V to 5.25V.

b. Ripple to be measured with a bandwidth of at least 200 MHz.

Table 5: Electrical Characteristics

Description	Symbol	Min.	Typ.	Max.	Units	Notes
SPI Slave Interface Clock Frequency	f _{SPI}	1	12	25	MHz	—
Low Level Input Voltage	VIL	-0.3	—	0.8	V	—
High Level Input Voltage	VIH	2	—	3.6	V	—
Low Level Output Voltage	VOL	—	—	0.8	V	—
High Level Output Voltage	VOH	2.8	—	—	V	—
Output Current of SDO	I _{SDO}	3	—	8	mA	—
Peak Laser Current	I _{VDDL_peak}	—	28	30	mA	—
Average Laser Current	<I _{VDDL} >	0.1	1	2	mA	a
Average Sensor Current	<I _{VDD} >	—	32	40	mA	—
Active System Power Consumption	P _{diss,total}	—	165	231	mW	b
Power Up Time	t _{poweron}	—	—	1	ms	c
Initialization Time	T _{init}	—	300	—	ms	d

a. Assumes Laser Class 1 operation.

b. Assumes a constantly active device, no use of standby modes in between two frames.

c. Time until the device is ready to accept commands.

d. Initialization/boot up time from first access to start of measurement.

Optical Module Performance Summary

AFBR-S50MV68B is one of the most flexible Time-of-Flight measuring modules available in the market. It provides an excellent sensitivity combined with a very wide dynamic range, best-in-class ambient light suppression, and supports short measurement cycles. Of course, all those performance parameters typically cannot be optimized at the same time. Therefore, useful configurations for certain applications are supported and can be selected on-the-fly in the driver software to allow for a combination and time interleaved operation of different modes.

Unless otherwise specified, all parameters in the following table are applicable for all operating conditions.

Table 6: Optical and Sensor Characteristics

Description	Symbol	Min.	Typ.	Max.	Units	Notes
Emission Wavelength	λ	670	680	690	nm	—
Beam Divergence 1/e2 Full Width	Θ_{full_ver}	0.1	0.4	0.7	°	a
Squint Angle Rx FOV Horizontal	Φ_{Rx}	—	2.7	—	°	a
Light Spot Diameter at 1000-mm	D_{1000_hor}	1.7	7	12.2	mm	b
Pixel FoV at 100-mm Distance	D_{pix100}	—	2.7	—	mm	—
Pixel FoV at 1000-mm Distance	$D_{pix1000}$	—	27	—	mm	—
Pixel FoV at 10,000-mm Distance	$D_{pix10000}$	—	270	—	mm	—
Number of Actively Illuminated Pixels	$\#Pix_{illum}$	1	—	3	#	—
Number of Available Pixels	$\#Pix$	—	32	—	#	—
Pitch of Detector Pixels	d_{pix}	—	150	—	μm	—
Bitclock	f_{bit}	48	96	192	MHz	—
Actual Laser Pulse Length (Pattern)	t_{pulse}	10.4	20.8	41.6	ns	—
Analog Integration Time per Phase	t_{int}	0.01	10	40	μs	c
Frame Rate (All pixels, max. t_{int} 20 μs)	f_{frame_max}	5	25	1000	Hz	d, e
Frame Rate (16 Pixels, max. t_{int} 10 μs)	f_{frame_max}	5	25	2000	Hz	d, f
Frame Rate (8 Pixels, t_{int} max. 5 μs)	f_{frame_max}	5	25	3000	Hz	d, g
Measurement Range	d_{meas}	10	—	10,000	mm	h
Distance Resolution	Δd_{res}	—	0.1	—	mm	—
Precision	σ	0.5	10	—	mm	i
Absolute Accuracy of Zero Point (Offset)	Δd_{abs}	-15	—	15	mm	j, k
Relative Distance Accuracy	Δd_{rel}	—	± 1	—	%	j
Ambient Light Illuminance Suppression	E_{AL}	—	50,000	100,000	lx	l
Eye Safety IEC 60825-1:2014	Class	—	1	—	—	m

- a. Utilizing optics and laser optimized for the usage of typically 1 pixel for increased sensitivity on the receiving side.
- b. See [Figure 21](#) for spot diameters at other distances.
- c. Automatically configured by the API, it is set to maximize signal amplitude by maintaining laser class I.
- d. The minimum value applies to device software versions v1.3.5 and below. Higher versions support lower frame rates.
- e. Maximum 40-ns pulses, all pixels active, SPI clock minimum 12 MHz, analog integration time limited by eye safety.
- f. Maximum 40-ns pulses, 16 pixels active, SPI clock minimum 21 MHz, analog integration time limited by eye safety.
- g. Maximum 40-ns pulses, 8 pixels active, SPI clock minimum 21 MHz, analog integration time limited by eye safety.
- h. The maximum measurement range depends on target remission, ambient light, and sensor configuration.
- i. Depending on remission and distance of object, pulse length, and integration time. (Typical value for 8% Remission at 4m distance with about 1-klx ambient light at 25°C.) See [Figure 8](#).
- j. Best accuracy values are achieved in short range mode and individual crosstalk calibration (API) for our default pixel binning settings with amplitudes larger 100 LSB at 25°C 1-klx background light.
- k. Measured at a distance of 1.5m with a target of at least 90% remission.
- l. The maximum value is 100 klx (AM 1.5) on a 45% remission target or 50 klx on a 90% remission target.
- m. Laser class depends on the software configuration; default operation is for IEC Laser Class 1. The customer must follow and fulfill the Broadcom SW and HW design recommendations to achieve Laser Class 1. Without the correct configuration or before the integration has been completed, the module can emit at higher levels and must be rated as a Laser Class 3B device.

Example Characteristics

To show the dependencies of measured distance repeatability and maximum detectable distance, a set of example characteristics are presented in the graphs on the following pages. Repeatability error is referred to as precision. Precision values and the maximum usable distance depend on the target reflectivity or remission (undirected reflectivity with lambertian characteristics), in combination with an ambient light illumination of the target.

The average output power is selected to meet Laser Class 1 eye safety. The laser pulse lengths can be chosen to allow for either of the following:

- High precision and accuracy (short range mode).
- or -
- Maximum sensitivity at the expense of larger distance noise (long range mode).

The native unambiguous range is 6.25m for short range mode and 12.5m for long range mode. It is extended by a factor of eight to 50m and 100m, respectively, if the dual frequency mode is selected. Dual frequency mode is supported for frame rates up to 100 Hz. By default, the short range mode is selected with dual frequency mode enabled. [Figure 8](#) through [Figure 11](#) and [Figure 14](#) through [Figure 17](#) show the typical precision values as a function of target distance and target remission (4% for deep black, 8% for metallic black, 18% for gray, and 90% for white) for both range modes. By changing the sensor configuration in the software, this limit can be further increased if required, on the expense of precision and maximum possible frame rates. The following general trends apply to all scenarios:

1. Precision scales with the square root of the frame rate. Because the frame rate determines the number of analog measurements per frame and not the length of each individual analog measurement, it does not directly affect the detection limit or maximum usable range.
For example, lowering the frame rate from 100 Hz to 25 Hz will reduce the precision error by a factor of two. See [Figure 20](#) for the relation between frame rate and measurement noise normalized to the default frame rate of 25 Hz.
2. Precision also scales with pulse length (the shorter the pulses, the smaller the error), but short pulses also degrade detection limit due to additional noise of the larger bandwidth.
3. The influence of ambient light can be efficiently compensated; however, the remaining additional shot noise degrades both detection limit as well as repeatability error.

To achieve optimum precision values, the APD gain, the integration depth, as well as the laser modulation current are automatically adjusted by the ToF driver software according to the current illumination conditions.

If not otherwise specified, the following charts indicate measurements on a plane target with a size bigger than the spot size at each condition.

Characterization Graphs

Figure 8: Typical Precision [mm] over Distance [m] – 1 klx, Short Range Mode

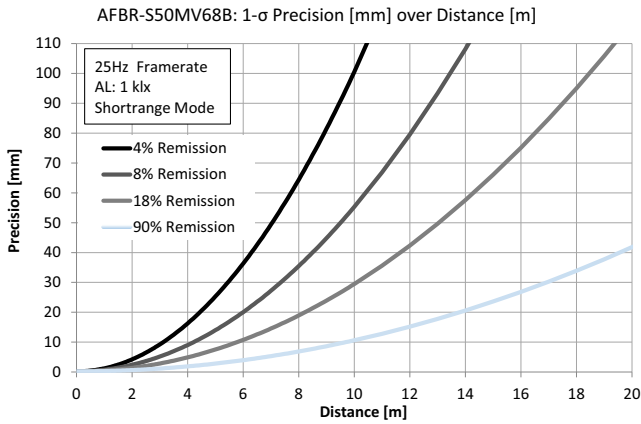

Figure 9: Typical Precision [mm] over Distance [m] – 10 klx, Short Range Mode

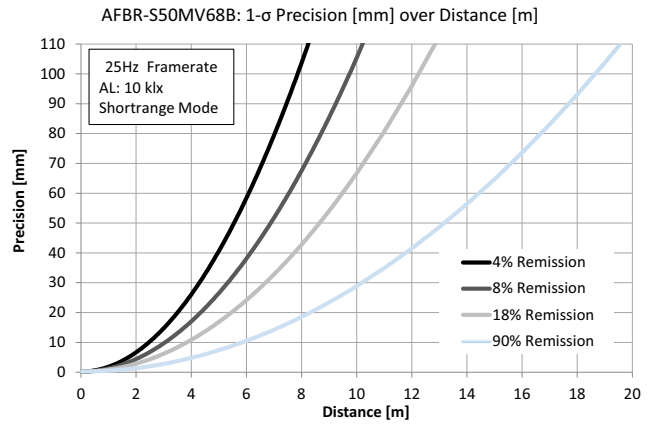

Figure 10: Typical Precision [mm] over Distance [m] – 50 klx, Short Range Mode

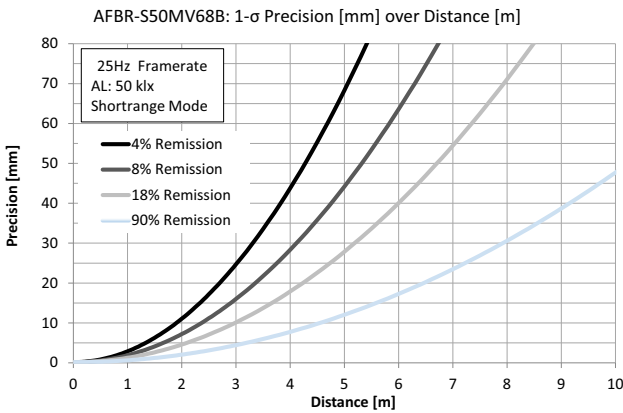

Figure 11: Typical Precision [mm] over Distance [m] – 100 klx, Short Range Mode

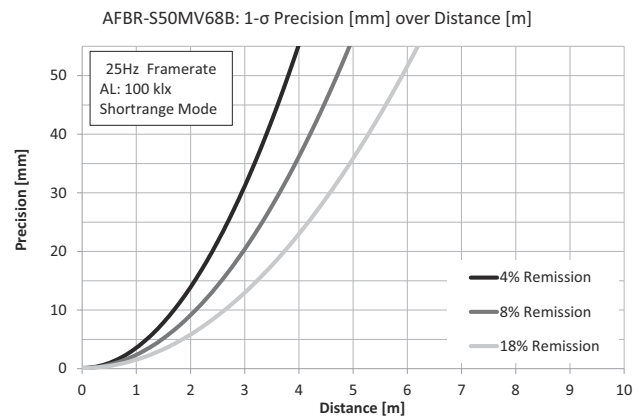

Figure 12: Typical Maximum Range [m] over Ambient Light [klx], Short Range Mode

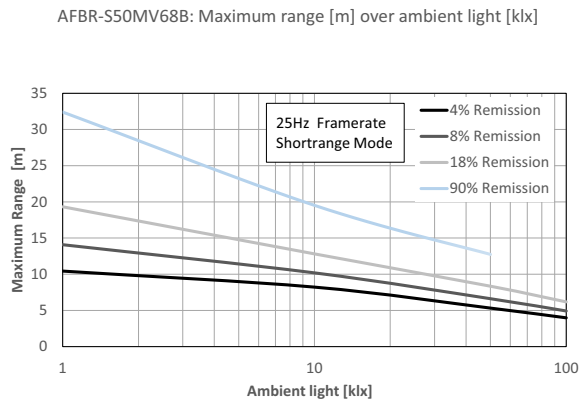

Figure 13: Typical Maximum Range [m] over Ambient Light [klx] and Target Size, Short Range Mode

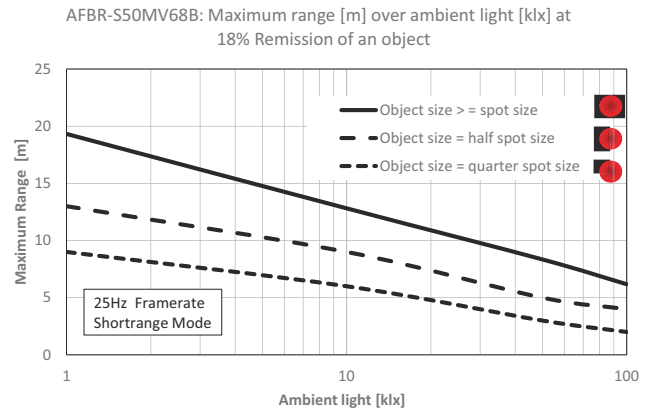

Figure 14: Typical Precision [mm] over Distance [m] – 1 klx, Long Range Mode

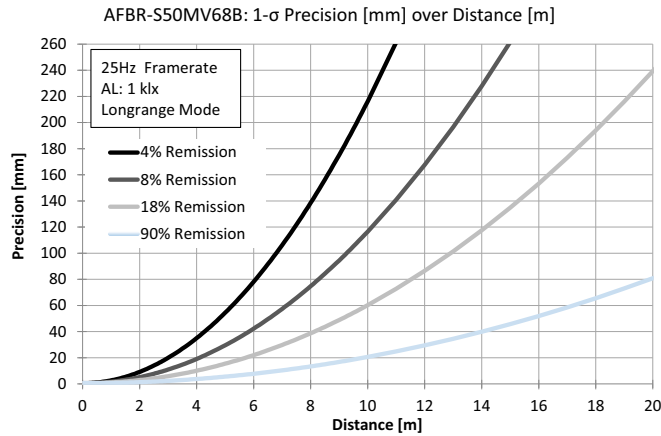

Figure 15: Typical Precision [mm] over Distance [m] – 10 klx, Long Range Mode

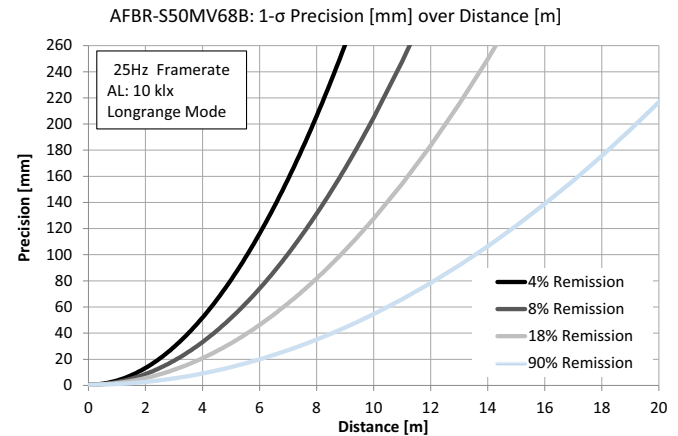

Figure 16: Typical Precision [mm] over Distance [m] – 50 klx, Long Range Mode

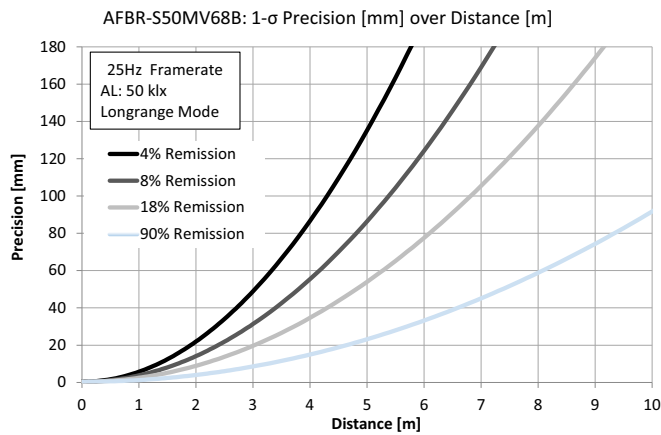

Figure 17: Typical Precision [mm] over Distance [m] – 100 klx, Long Range Mode

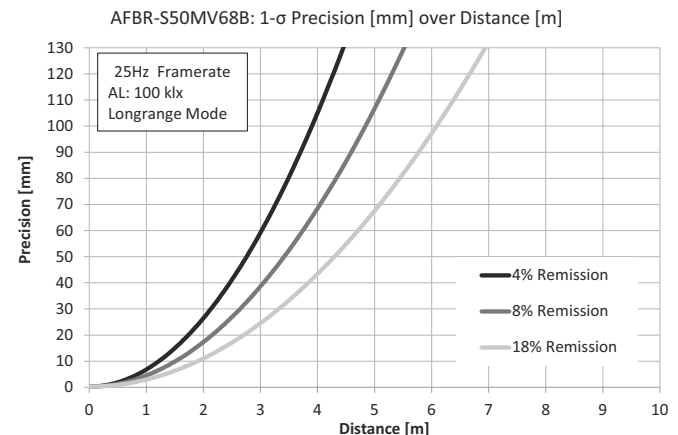

Figure 18: Typical Maximum Range [m] over Ambient Light [klx], Long Range Mode

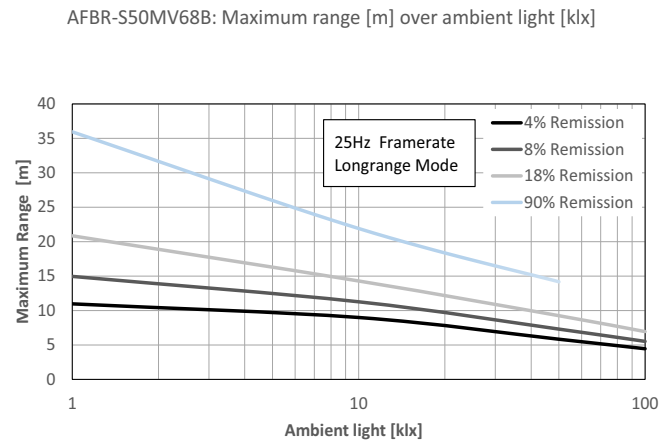

Figure 19: Typical Maximum Range [m] over Ambient Light [klx] and Target Size, Long Range Mode

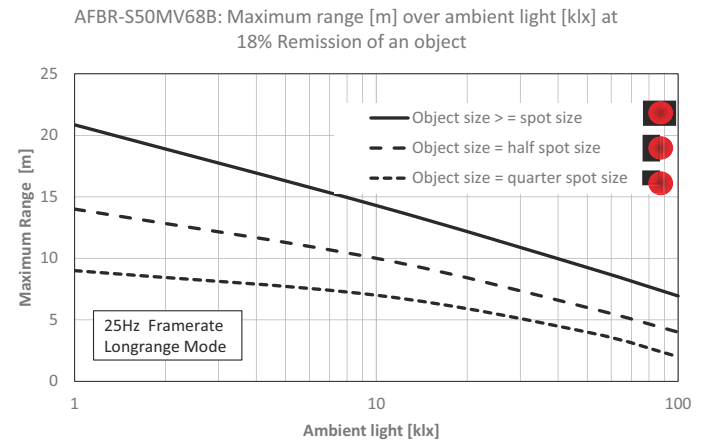

Figure 20: Typical Measurement Noise Factor over Frame Rate [Hz]

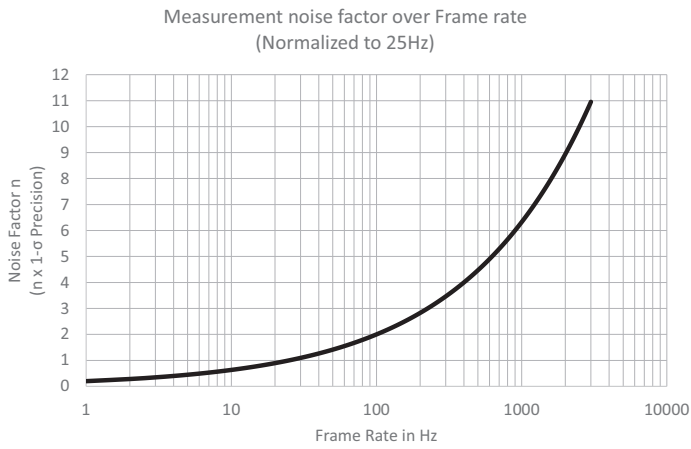
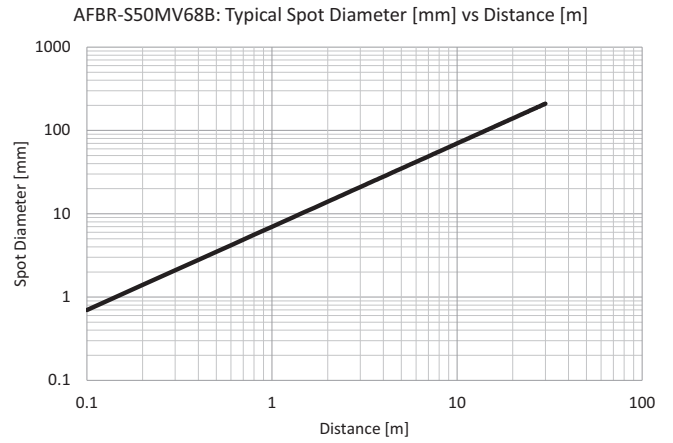

Figure 21: Typical Spot Diameter [mm] over Distance [m]



Digital Interface Characteristics

The register access is performed with a standard four-wire serial peripheral interface (SPI), which is available in all common microcontrollers. It can be run with up to 25-MHz clock frequency.

The default mode is SPI mode 3, which translates into Clock Polarity CPOL = 1 (base value of clock is high) and Clock Phase CPHA = 1 (data output on falling edge, data are captured on rising edge). The chunk size is 8 bits (8 address bits, multiples of 8 data bits) and the endianness is “big endian” (most significant bit first). The timing relations are sketched in [Figure 22](#).

Figure 22: SPI Timing Diagram

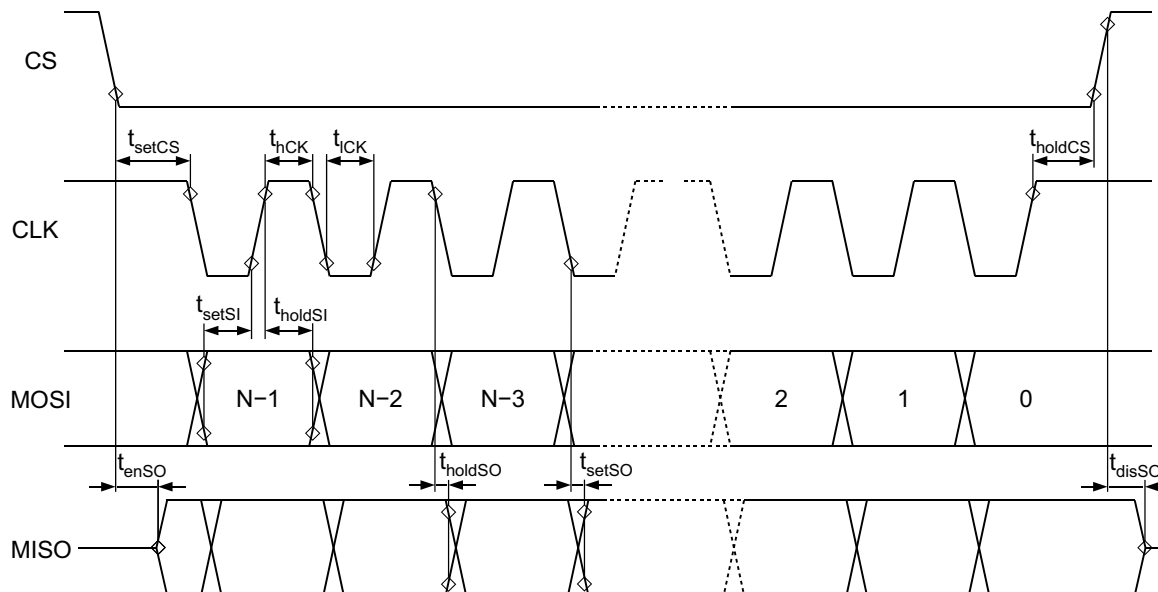

Table 7: SPI Slave Interface Timing Parameters

Description	Symbol	Min.	Typ.	Max.	Units	Notes
SPI Clock Frequency	f_{SPI}	1	12	25	MHz	—
SPI Clock High Period	T_{hCK}	—	20	—	ns	—
SPI Clock Low Period	T_{ICK}	—	20	—	ns	—
Input Logic Low Hysteresis	V_{IL}	—	—	1	V	—
Input Logic High Hysteresis	V_{IH}	2.18	—	—	V	—
Output Rise Time	t_{rO}	—	—	9	ns	1-pF load
Output Fall Time	t_{fO}	—	—	2.1	ns	10-pF load
Output Low Strength	I_{sLO}	13.5	—	—	mA	$V_{\text{o}} = 0.8\text{V}$
Output High Strength	I_{sHO}	2.5	—	—	mA	$V_{\text{o}} = 2.4\text{V}$
Chip Select Set Time	t_{setCS}	—	20	—	ns	—
Chip Select Hold Time	t_{holdCS}	—	20	—	ns	—
Data Input Set Time	t_{setSI}	—	15	—	ns	—
Data Input Hold Time	t_{holdSI}	—	15	—	ns	—
Data Output Enable Time	t_{enSO}	1.7	—	—	ns	—
Data Output Disable Time	t_{disSO}	—	—	18.6	ns	—

Application Circuit and Layout Recommendations

The TOF sensor module requires local power supply filtering to limit voltage ripple based on dynamic variations of current consumption and respective noise coupling into the module, as well as coupling back into the application circuit using the supply rails VDD and VDDL. The main noise source is the laser driver, which generates pulses of the order of 50 mA for a few ns lengths, mainly drawn from the VDDL supply rail. The respective noisy GND is denoted as GNDL. The short pulses should be buffered with a 100-nF ceramic capacitor placed close to the VDDL and the GNDL pin with a sufficiently high frequency response (impedance of less than 0.5Ω between 10 MHz and 200 MHz, such as in the X7R type in a 0603 SMD package). Because the pulses are grouped into bursts, another larger capacitor referenced to GNDL should be used to stabilize the supply, followed by a bead and another 10-μF capacitor referenced to GND (Pi filter) to block noise in both directions. At this point, VDD and VDDL can be combined on the PCB to a single 5V supply rail. Because a similar switching noise must be filtered for the sensor supply VDD, both VDD supply pins should be buffered against GND with a 100-nF. GNDL directly connected to a highly conductive GND plane.

There is no need to place an external oscillator, coils, or other active components except for a micro controller unit (MCU) for module configuration and data processing. Shortcuts with the conductive ring at pin head must be avoided. The following images show an example schematic for the application board integration and layout proposal based on a two-layer application PCB.

Figure 23: Application Schematic

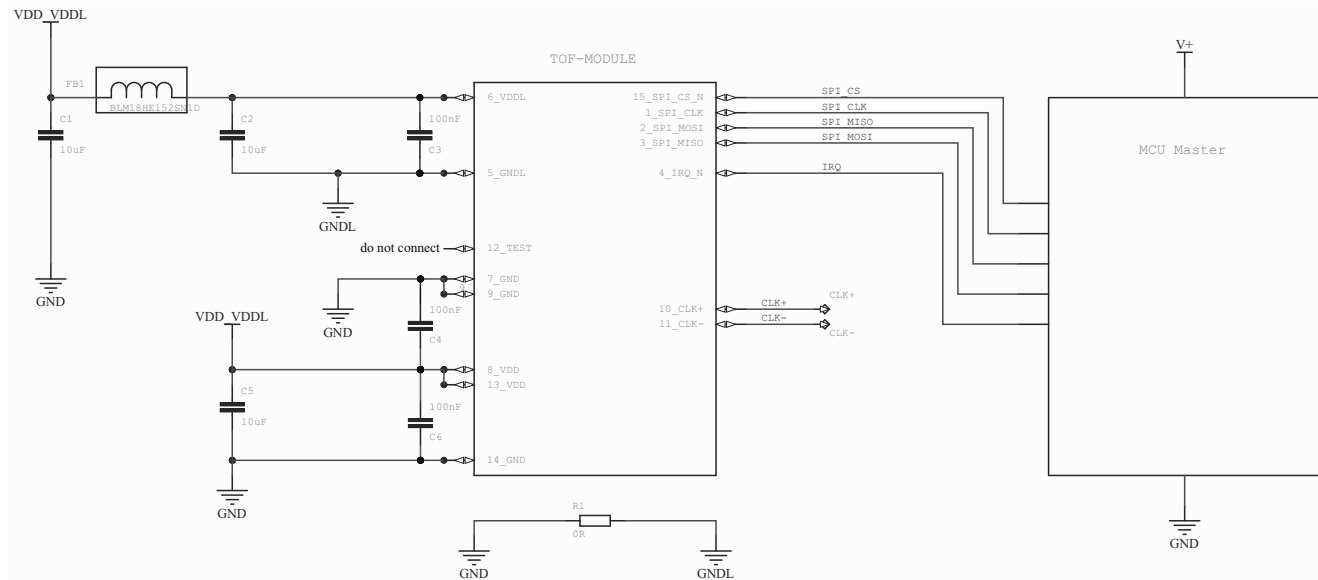
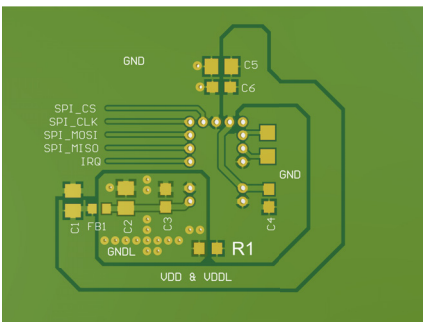

Figure 24: Application Layout (Showing the Top Layer of a Two-Layer PCB Design)



Driver Software and Software Development Kit Overview

The driver software contains all necessary parts for the sensor operation within a low-cost embedded system. It controls the laser, evaluates distances and amplitudes, regulates integration times, calibrates absolute distances and temperature effects, and chooses the optimal pixels depending on the application (either distance measurement or multi-pixel applications).

The module software package, containing the driver software core binaries including the API layers and example applications, is provided free-of-charge under a generic end user license agreement. The core binaries are embedded in a reference application that runs on the NXP/Freescale KL46Z, Cortex-M0+ platform. The reference application is distributed under the open source GNU GPL license. The driver software was developed with focus on portability to any low-power Arm Cortex-M, 32-bit based operation-system-less microcontroller platform. All calculations are based on fixed point-arithmetic, and no floating point unit is required.

In addition, Windows GUI software is provided for evaluation and graphical display of measurement results and easy configuration management. The GUI connects to the reference application using a generic systems communication interface (SCI) that sends and receives data packages over an USB connection.

For a detailed description, refer to the API reference manual supplied with each software release.

Figure 25: Driver Software Block Diagram

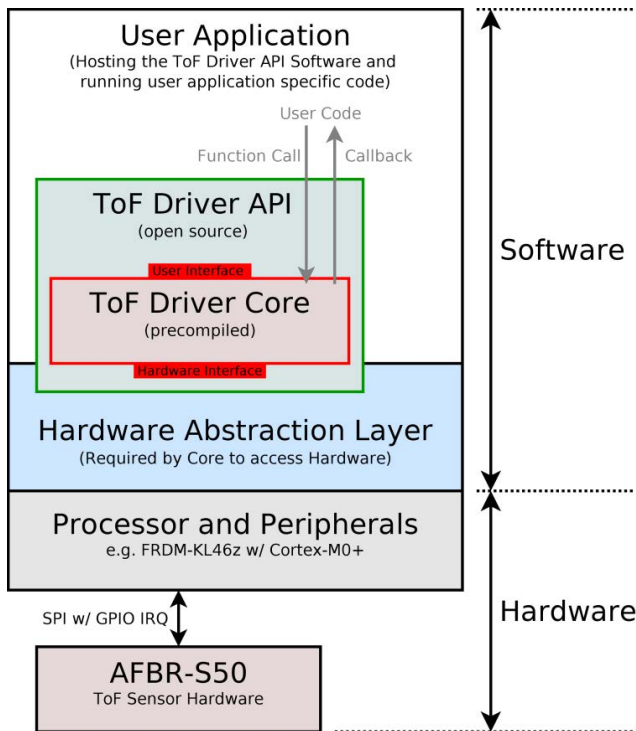

Figure 25 shows the software architecture overview for the basic implementation of the ToF Driver Core into user hardware and software. The precompiled core is embedded into open source API layers, providing an interface to the user application. A hardware interface declares the required hardware access for the ToF driver core to the underlying hardware and peripherals. The latter is required to connect the core to the AFBR-S50 ToF sensor hardware through the SPI and GPIO interfaces.

The ToF driver core provides functionality to take care of device control and communication, sensor calibrations, and measurement data evaluations. The API layers surrounding the core provide user and hardware interfaces to access the core from the application code and drive the required peripherals, respectively. The ToF driver core and API are implemented as hardware independent and can be ported to any Cortex-Mx-based microcontroller platform.

The ToF driver core is designed as an interrupt driven architecture, which allows operating the device in the background while concurrently executing heavy evaluation functionality in the foreground. No operation system is required because the background task is executed directly in the interrupt callbacks. The callbacks executed from the interrupt service routines are kept small to not result in a delayed or stalled system.

The device measurement cycle will be triggered either by a periodic interrupt timer (PIT) or by a user call to the corresponding asynchronous API function. The core will manage and update the device configuration dynamically to adapt to changing ambient (for example, distance, reflectivity, background light, and temperature) situations and trigger the device measurement cycle afterwards. After the measurement cycle has been performed autonomously on the chip, the raw data is read, and the user application is informed by invoking a callback.

To avoid overloading the interrupt service routines, the user application must call the evaluation and calibration task from the foreground or main thread to perform calculations and obtain calibrated measurement results, such as range per pixel in meter units. This can be done by calling the evaluation task function from a simple main loop, using a basic preemptive task scheduler or even a real time operation system (RTOS).

The core separates the measurement cycle into two main tasks:

- The device communication with the ToF hardware is performed using a standard SPI plus a single IRQ line to obtain the data ready event. The communication is fully automated in the background within small interrupt service routines. The only action the user application might need to take is on the trigger of a new measurement cycle. This can also be done from a periodic interrupt timer. The device is dynamically updated with new configuration parameters (obtained by evaluation of the previous results or user request) before the measurement data acquisition is started. After the measurement cycle is finished, the pending IRQ from the device initiates the data read-out, and a callback function is invoked to inform the user application of the data ready event.
- The data evaluation and calibration of the raw data is performed by a simple function call from the main thread to the API. Afterwards, useful information, such as range values, signal strength, or ambient light level, is available for further usage in the user application.

The following figure shows an example of the software API measurement task timing.

Figure 26: Software Timing Diagram

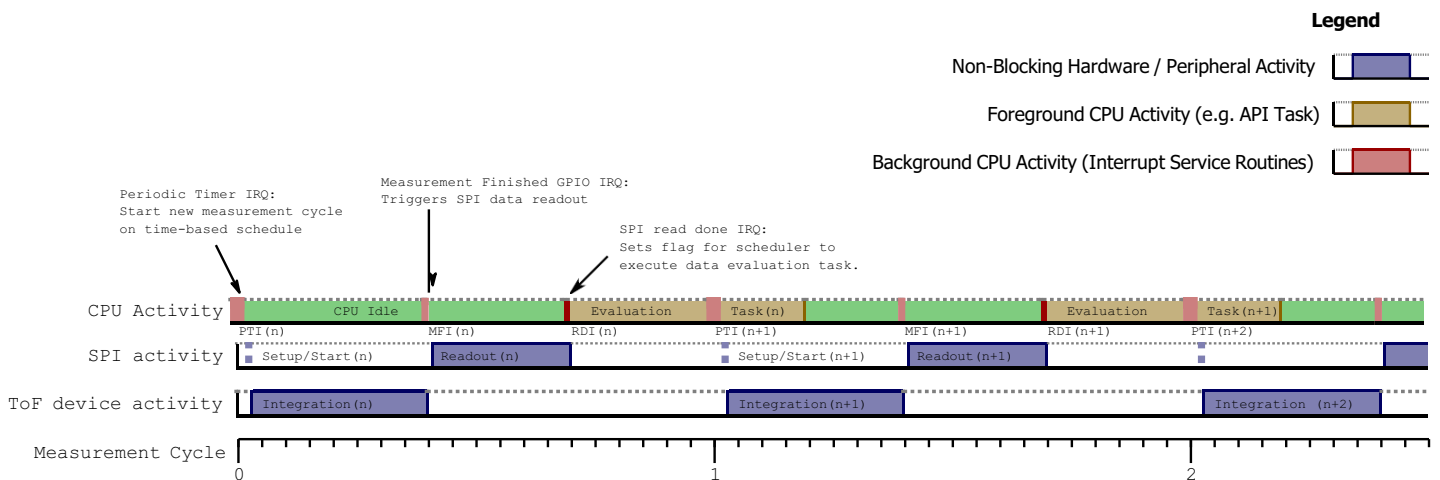

A periodic timer interrupt (PTI) triggers the measurements in the background on a time-based schedule. After the device configuration is updated, the integration cycle starts. The device will acquire all measurement data autonomously and raise the measurement finished interrupt (MFI) using a GPIO line upon finishing. The data is ready to read using the SPI interface. After the SPI communication is done, the user application is informed about the new data using a callback from the SPI read done interrupt (RDI). The user application is now responsible for calling the evaluation and calibration task for the received measurement data from the foreground or the main task. Meanwhile, the PTI triggers the next measurement frame independently of the current user application state.

NOTE: The length of the evaluation task depends on the platform and chosen algorithms, and it might be longer than the bare measurement frame time. This would lead to a delay of the measurement start and a slower frame rate.

In addition, there are several utility functions for calibration (for example, crosstalk/cover glass correction) and configuration (for example, frame rate, dynamic integration time adaption, and pixel binning for 1D measurement) provided that help to achieve best sensor performance for a vast variety of application scenarios.

To be portable, the API requires some interfaces to peripherals that must be implemented by the user for the platform of choice. The following are some of the interfaces:

- SPI with GPIO – Communication with the device is done using a standard four-wire SPI interface. An EEPROM is implemented in the chip that can be accessed through the SPI pins using a not-SPI-compatible protocol that is implemented in software using a bit-banging algorithm. Therefore, SPI pins must be accessible as GPIO pins, too.
- GPIO IRQ – A single GPIO interrupt input line is required for the measurement-finished interrupt.
- Timer 1 (mandatory) – To obey the eye-safety limits, a highly accurate and independent hardware timer is required for time measurement occasions.
- Timer 2 (optional) – To maintain a fixed frame rate and trigger measurements independently in the background, an additional periodic interrupt timer can be used.
- Nonvolatile memory (optional) – To permanently store user calibration and configuration data, a nonvolatile memory, such as flash, might be implemented.

In case the software stalls or the SPI interface is disturbed or breached, there is no risk of uncontrolled activity of the module. Because the measurement of each frame must be started by the software individually, the module stops all activities automatically as soon as the SPI chip select is enabled, or latest after the current frame measurement has been completed.

Software and Application Support

A download link to the AFBR-S50 SDK can be found on the AFBR-S50MV68B product page:

<https://www.broadcom.com/products/optical-sensors/time-of-flight-3d-sensors/AFBR-S50MV68B>

Or find the Github repository here:

<https://github.com/Broadcom/AFBR-S50-API>

For further application or technical support topics write an email to support.tof@broadcom.com or get in contact with your local sales representative.

Packaging and Ordering Information

The modules are shipped in tubes of 60 pieces each. The tube length is 50 cm.

Figure 27: Packing Details

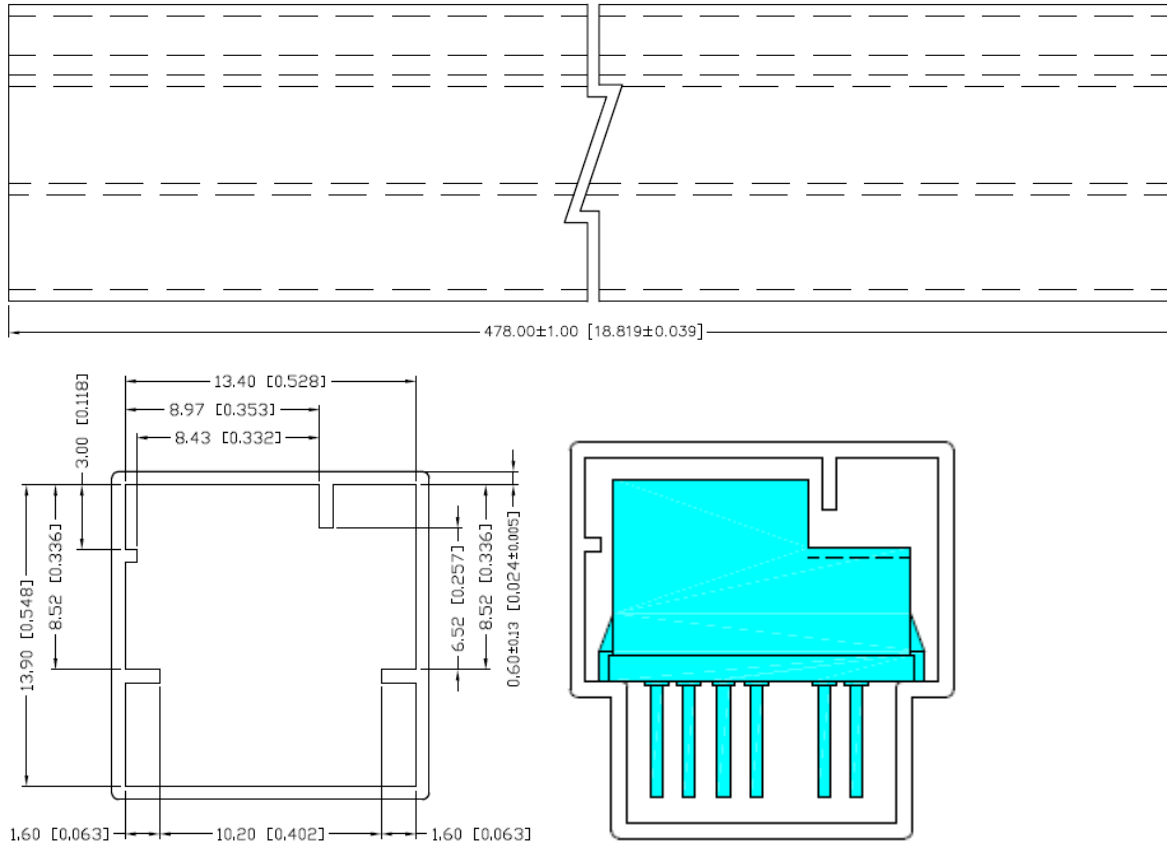

For checking availability and inventory at distribution channels, click the **Check Inventory** button of the AFBR-S50MV68B Product Page.

<https://www.broadcom.com/products/optical-sensors/time-of-flight-3d-sensors/AFBR-S50MV68B>

Copyright © 2020-2022 Broadcom. All Rights Reserved. The term “Broadcom” refers to Broadcom Inc. and/or its subsidiaries. For more information, go to www.broadcom.com. All trademarks, trade names, service marks, and logos referenced herein belong to their respective companies.

Broadcom reserves the right to make changes without further notice to any products or data herein to improve reliability, function, or design. Information furnished by Broadcom is believed to be accurate and reliable. However, Broadcom does not assume any liability arising out of the application or use of this information, nor the application or use of any product or circuit described herein, neither does it convey any license under its patent rights nor the rights of others.