

Part No. 9001002

GPS L1 and L2 Ceramic Patch Antenna

L2: (1215-1239.6) MHz & L1: (1563-1587) MHz

Supports: GNSS systems, Global antenna embedded systems, Satellite positioning systems



The KYOCERA AVX series of GPS Ceramic Patch Antennas are engineered to meet the critical requirements of device designers, delivering enhanced functionality and performance for a wide range of connected device applications. These cutting-edge antennas offer substantial benefits for L2 GPS band applications, such as precision agriculture or geodetic positioning.

GPS L1 & L2 Ceramic Patch Antenna

L2: 1215 – 1239.6 MHz

L1: 1563 – 1587 MHz

KEY BENEFITS

Reduced Costs and Time-to-Market

Standard antenna eliminates design fees and cycle time associated with a custom solution; getting products to market faster.

Quicker Time-to-Market

By optimizing antenna size, performance and emissions, customer and regulatory specifications are more easily met.

Environmental Compliance

Products are the latest RoHS version compliant.

APPLICATIONS

- M2M / IoT devices
- Security (Defense, Marine)
- Telematics devices
- Agriculture
- Geo-tracking
- Autonomous
- Vehicles
- Vehicle tracking/fleet management systems,
- Navigation devices

Electrical Specifications

Typical Characteristics, on 80 mm diameter circular EVB

Frequency	L2 (1215 - 1239.6) MHz	L1 (1563 – 1587) MHz
Peak Gain	3.8 dBi	4.4 dBi
Average Efficiency	65%	75%
Return Loss	< -2.5 dB	< -17 dB
Gain @ Zenith	3 dBi	4 dBi
Axial Ratio	< 3 dB	
Power Handling	2 Watt CW	
Feed Point Impedance	50 Ω unbalanced	
Polarization	R.H.C.P	
Radiation Pattern	Directional	

Mechanical Specifications & Ordering Part Number

Ordering Part Number	9001002
Size (mm)	38 x 38 x 8.16
Mounting	Adhesive & Pin
Storage Temperature(°C) / Humidity (%)	0 to 50°C / 85%
Operation Temperature(°C) / Humidity (%)	-40°C to 105°C
Weight (grams)	30.0
Packaging	Tray

GPS L1 & L2 Ceramic Patch KYOCERA AVX Embedded Antenna Specifications.
 KYOCERA AVX produces a wide variety of standard and custom antennas to meet user needs

Return Loss Plots

Typical performance on 80mm diameter circular EVB

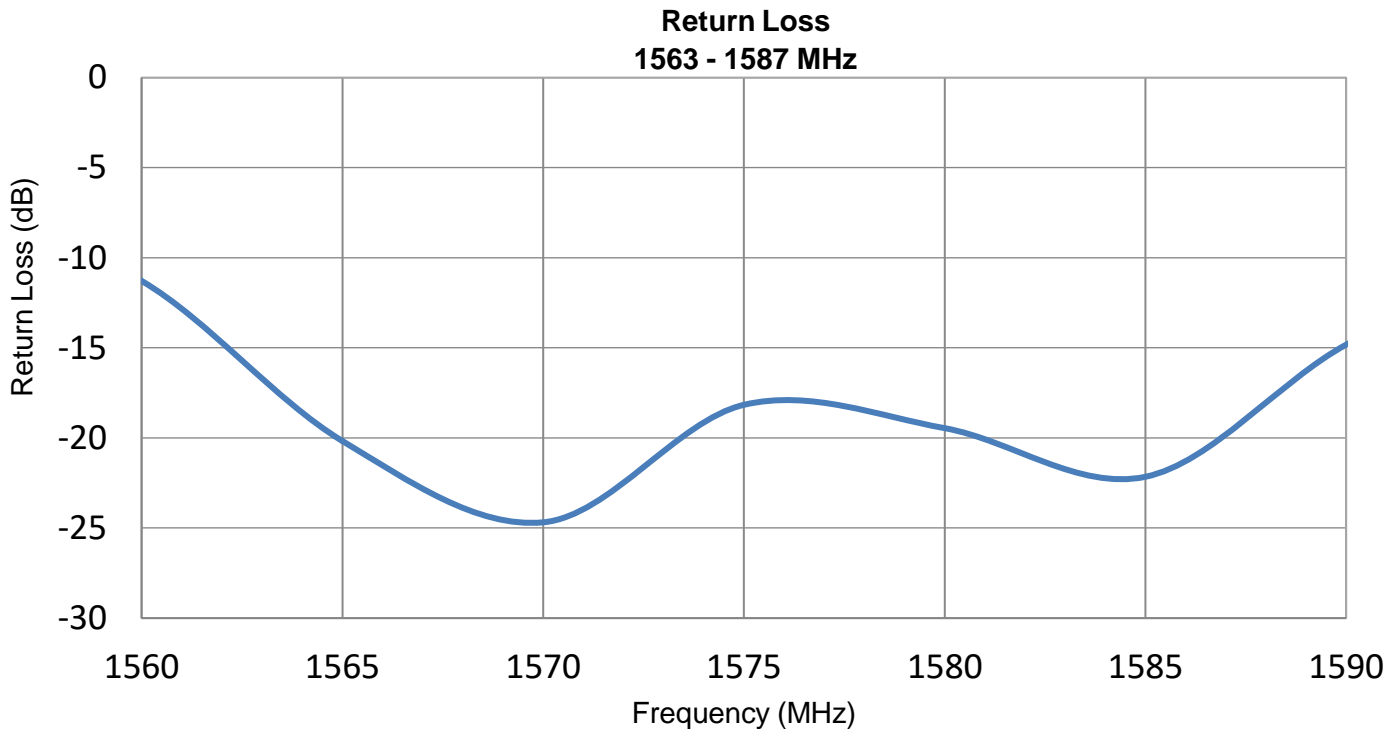
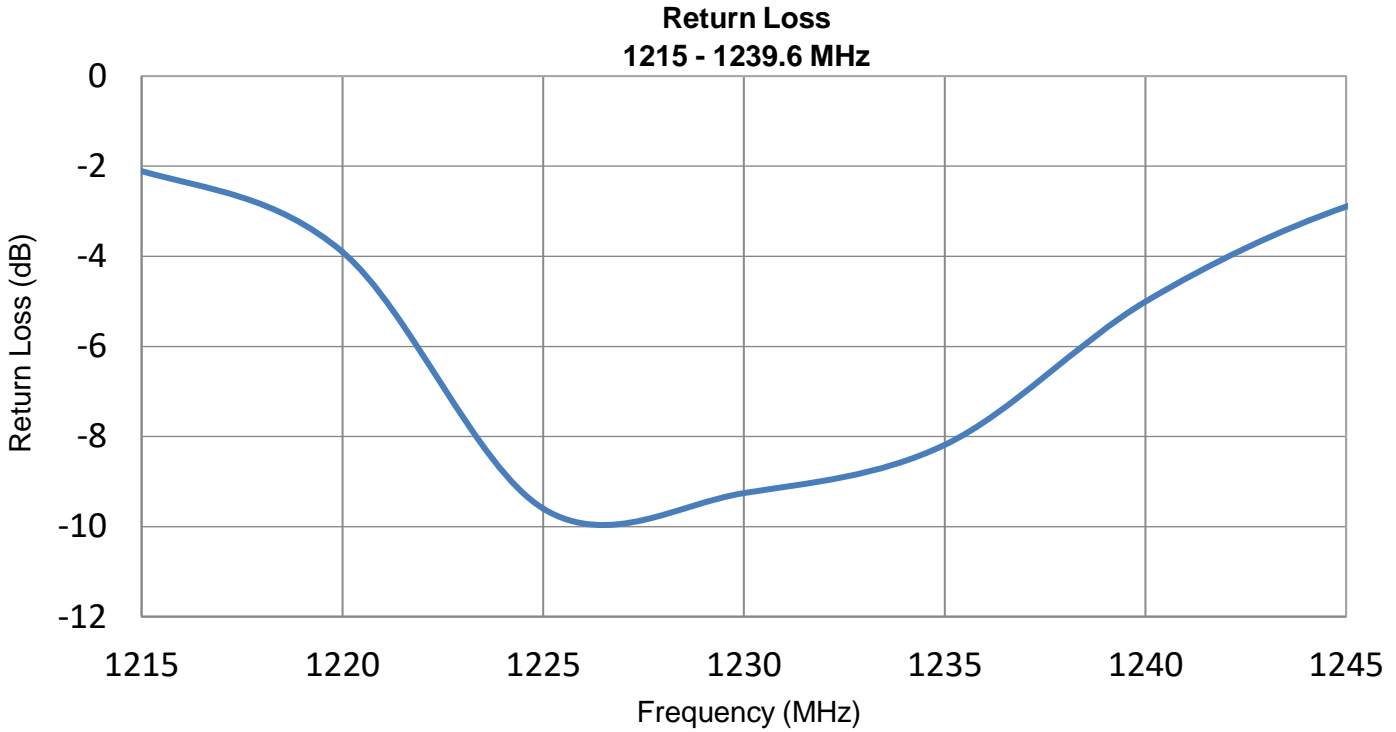

GPS L1 & L2 Ceramic Patch KYOCERA AVX Embedded Antenna Specifications.
 KYOCERA AVX produces a wide variety of standard and custom antennas to meet user needs

Efficiency Plots

Typical performance on 80mm diameter circular EVB

**Efficiency
1215 - 1239.6 MHz**

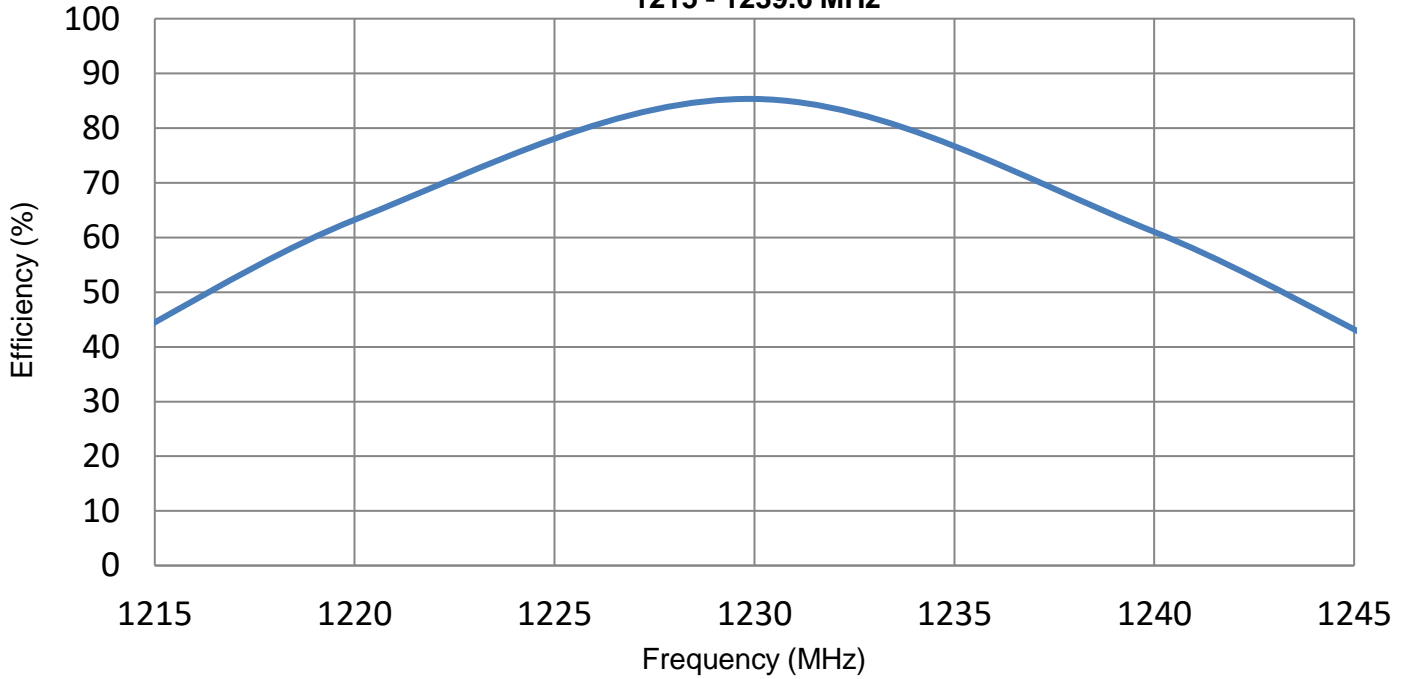

**Efficiency
1563 - 1587 MHz**

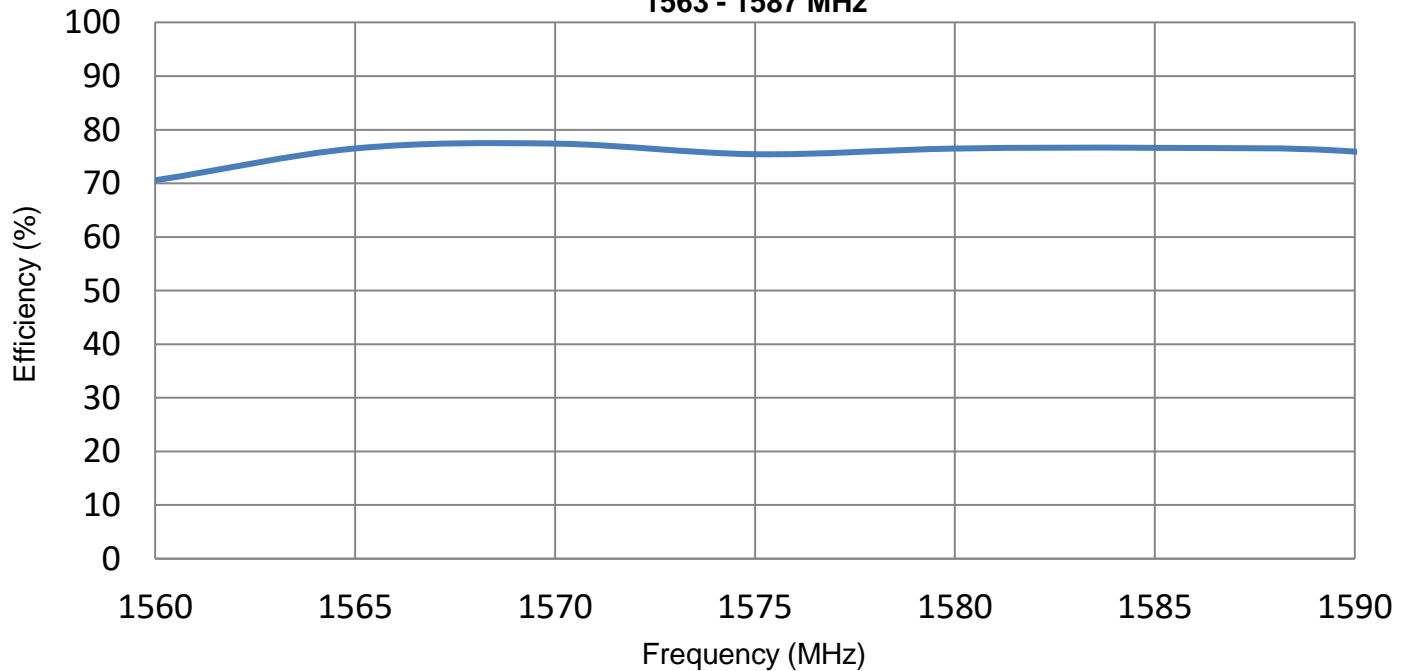

GPS L1 & L2 Ceramic Patch KYOCERA AVX Embedded Antenna Specifications.
 KYOCERA AVX produces a wide variety of standard and custom antennas to meet user needs

Peak Gain Plots

Typical performance on 80mm diameter circular EVB

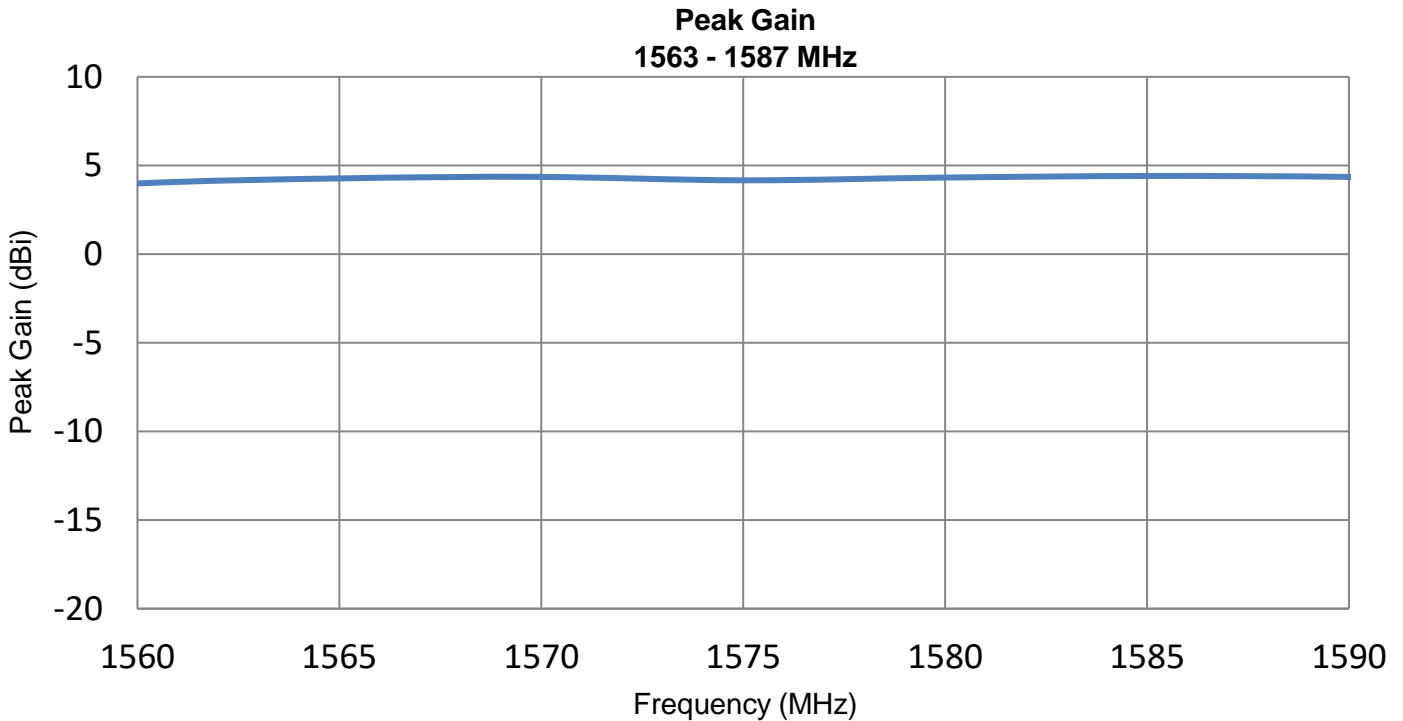
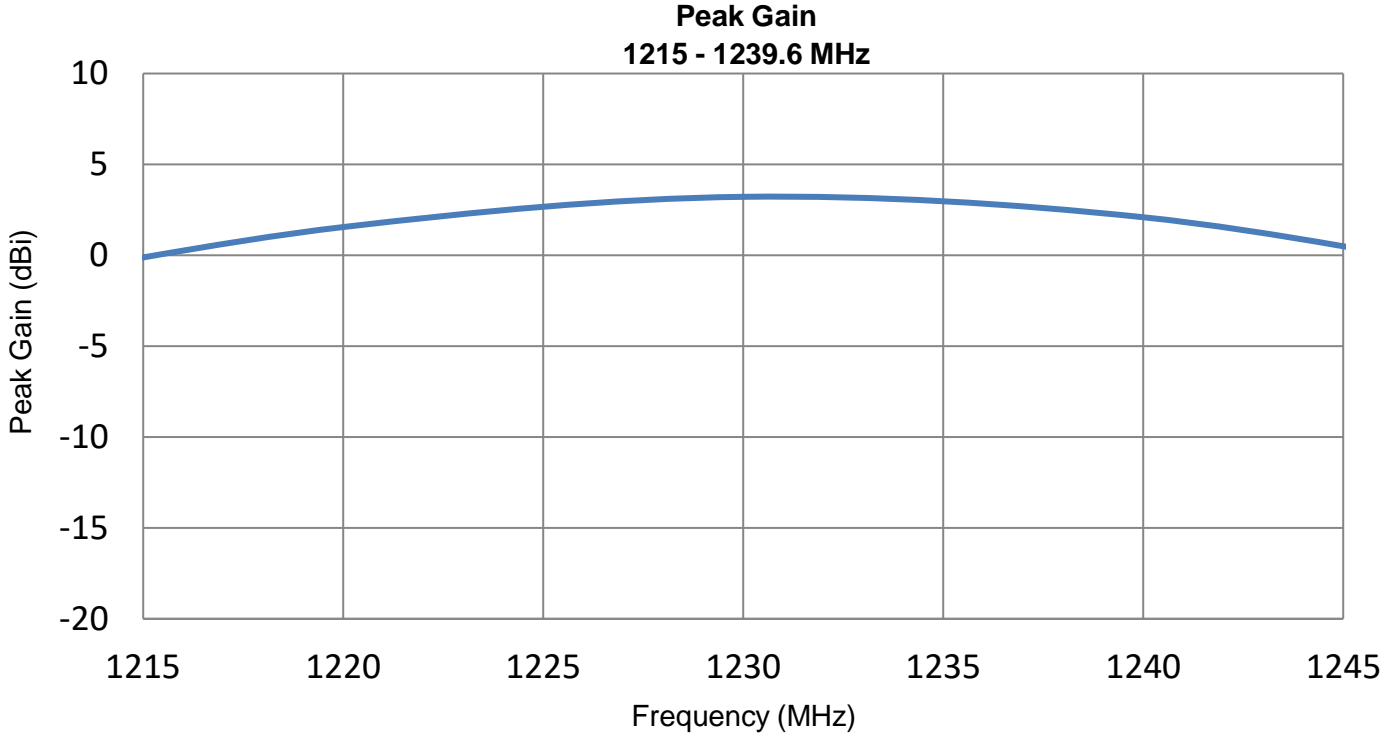

GPS L1 & L2 Ceramic Patch KYOCERA AVX Embedded Antenna Specifications.
 KYOCERA AVX produces a wide variety of standard and custom antennas to meet user needs

R.C.H.P Plot

Typical performance on 80mm diameter circular EVB

R.C.H.P Phi = 0°

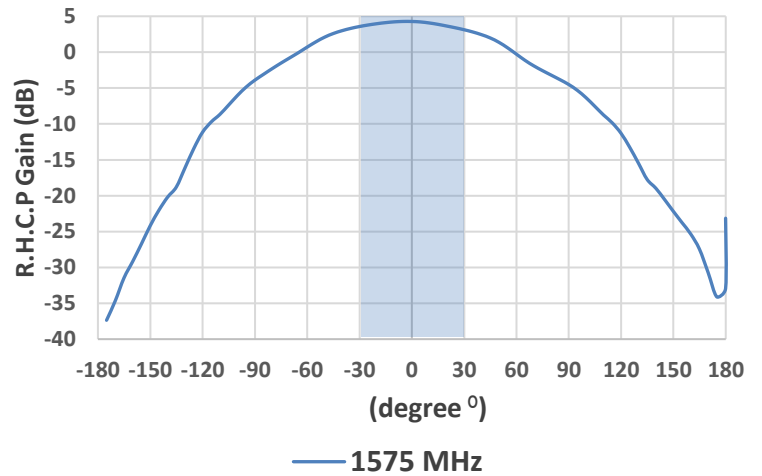
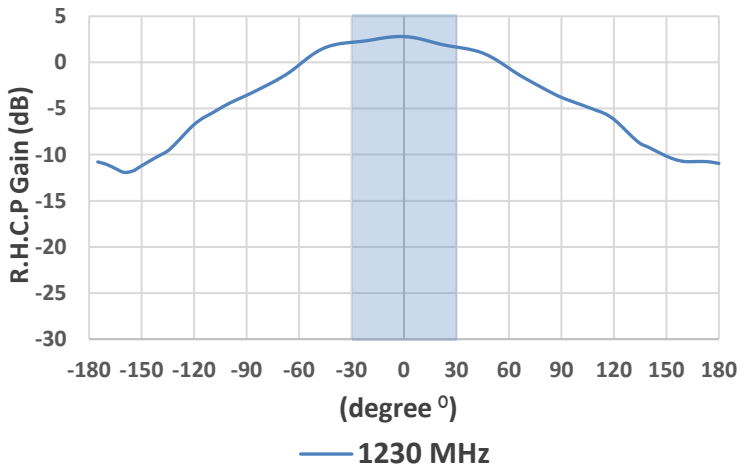

R.C.H.P Phi = 90°

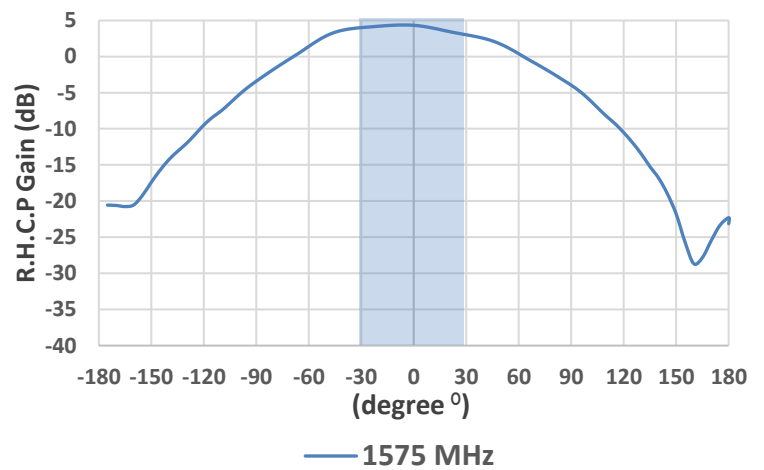
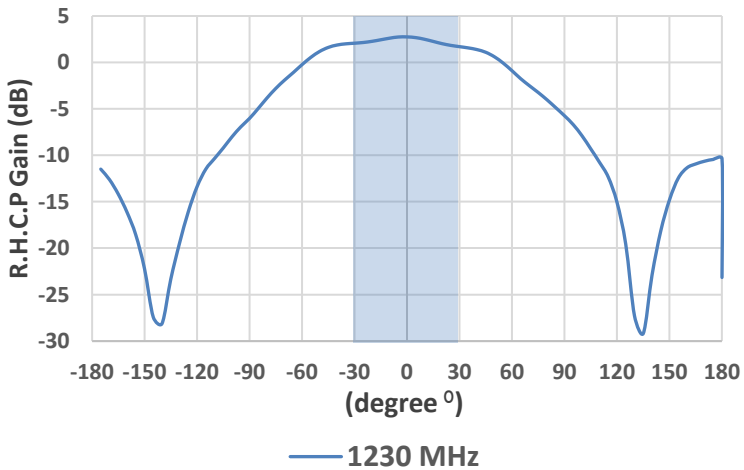

GPS L1 & L2 Ceramic Patch KYOCERA AVX Embedded Antenna Specifications.
 KYOCERA AVX produces a wide variety of standard and custom antennas to meet user needs

Axial Ratio Plots

Typical performance on 80mm diameter circular EVB

Axial Ratio Phi = 0°

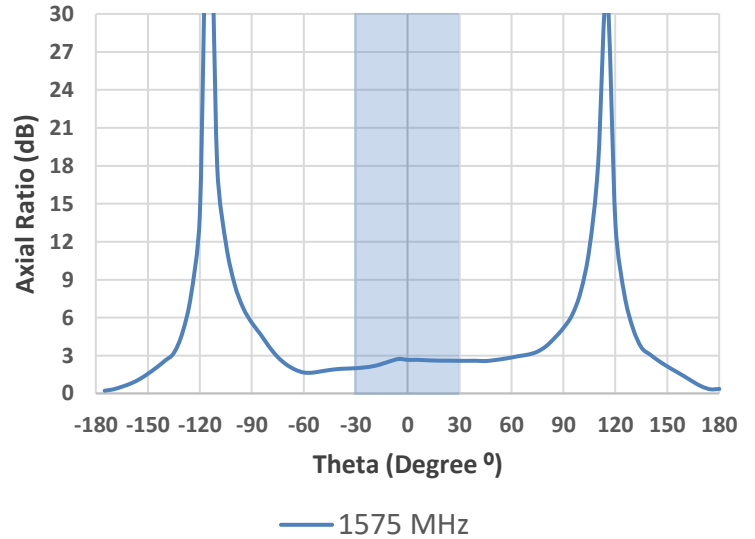
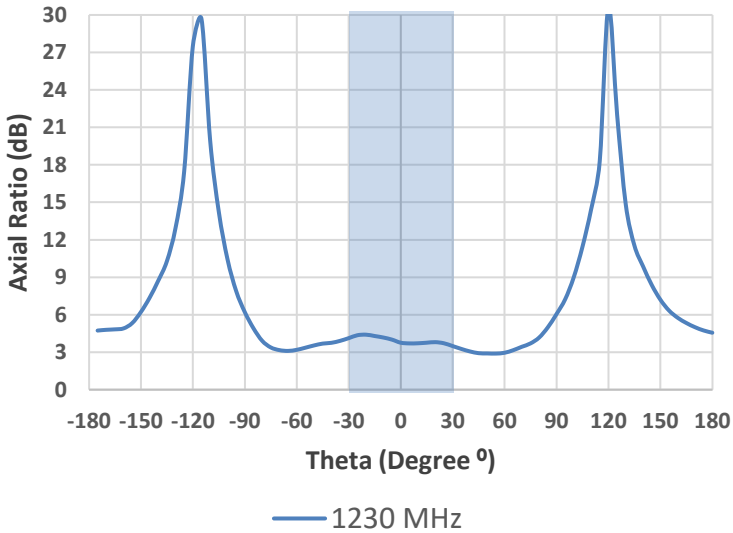

Axial Ratio Phi = 90°

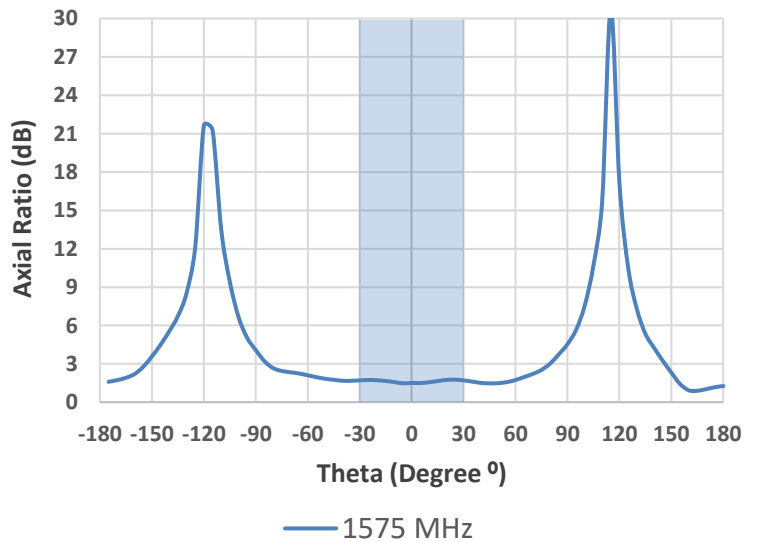
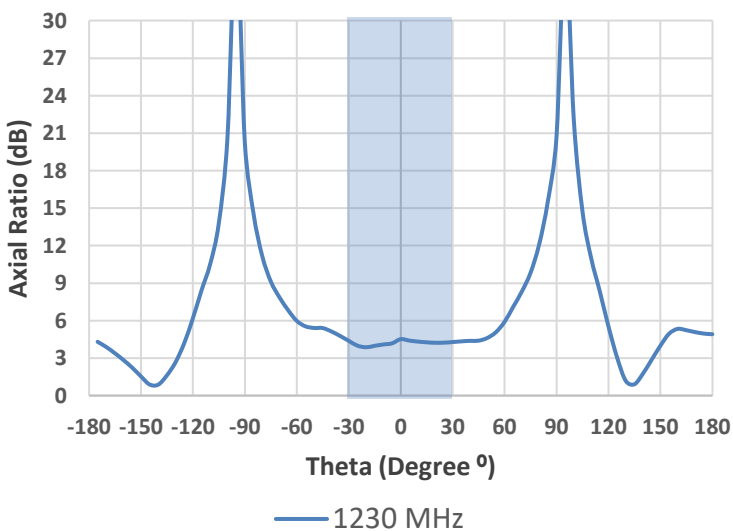

GPS L1 & L2 Ceramic Patch KYOCERA AVX Embedded Antenna Specifications.
 KYOCERA AVX produces a wide variety of standard and custom antennas to meet user needs

Antenna Radiation Patterns

Typical performance on 80mm diameter circular EVB
 Measured @ 1215 – 1239.6 MHz

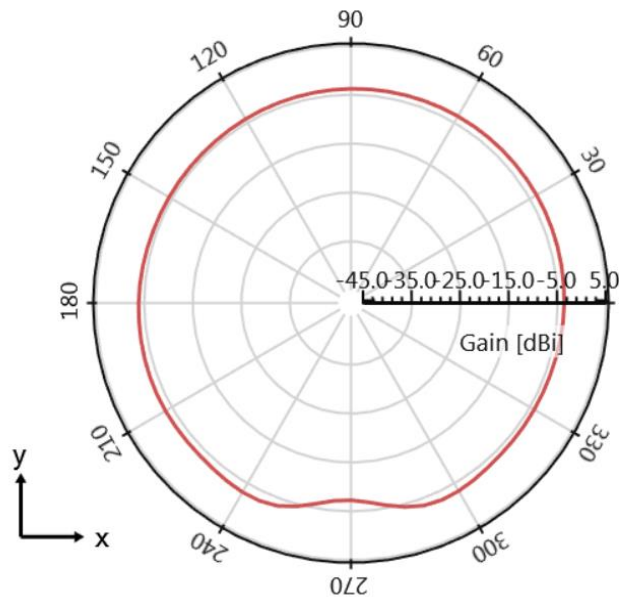
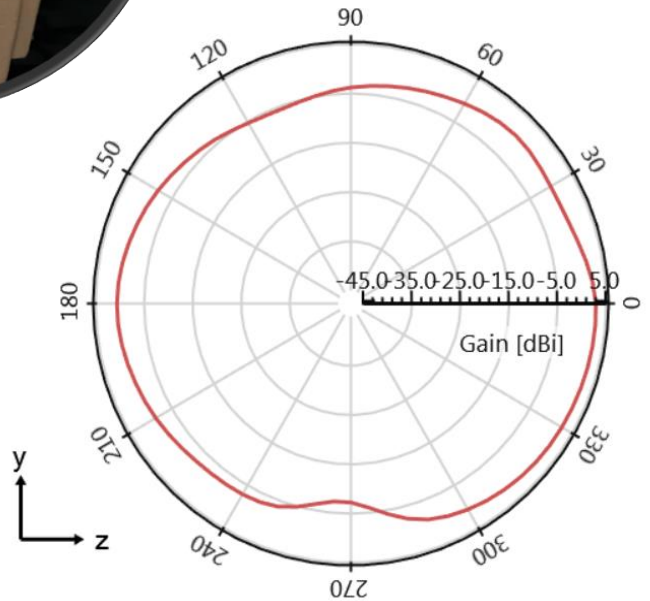
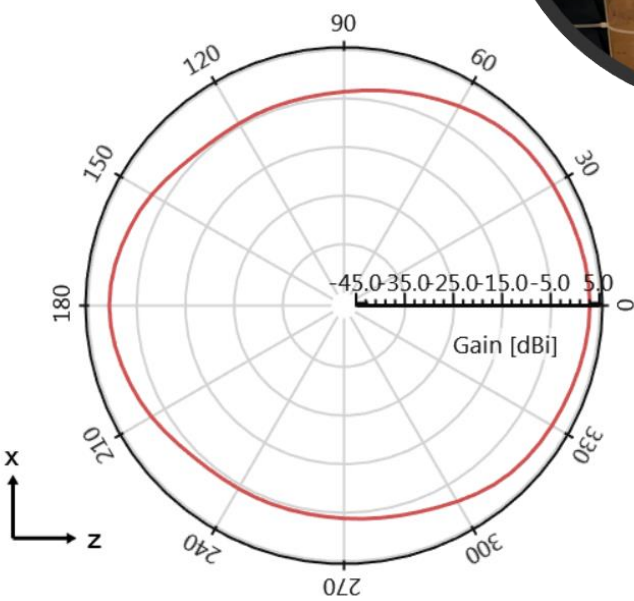
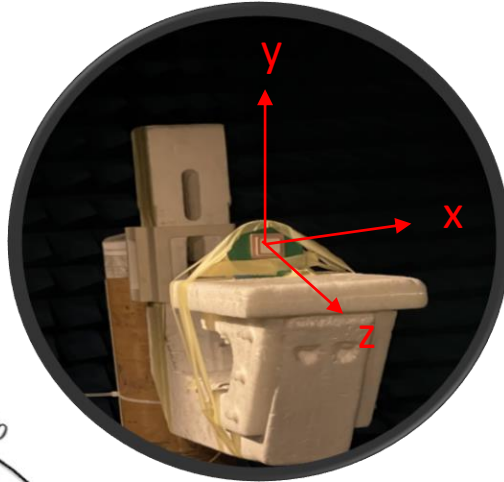

GPS L1 & L2 Ceramic Patch KYOCERA AVX Embedded Antenna Specifications.
 KYOCERA AVX produces a wide variety of standard and custom antennas to meet user needs

Antenna Radiation Patterns

Typical performance on 80mm diameter circular EVB
 Measured @ 1563 – 1587 MHz

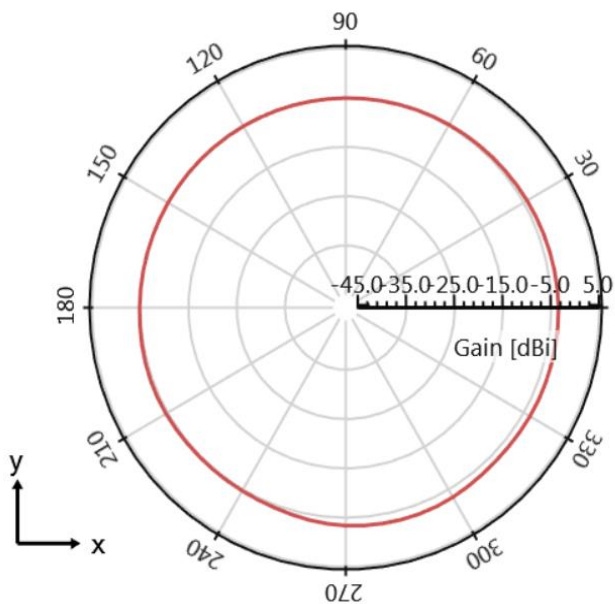
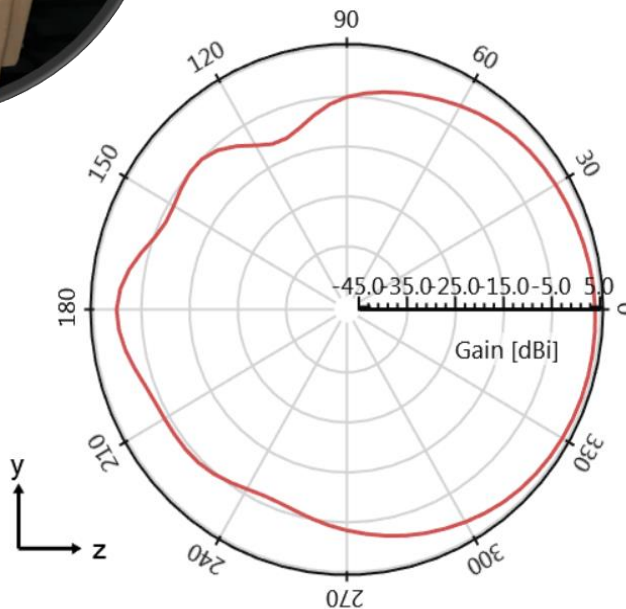
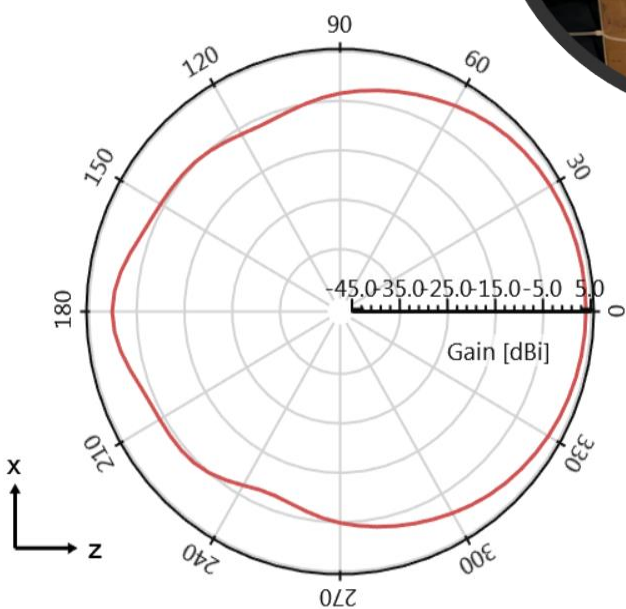
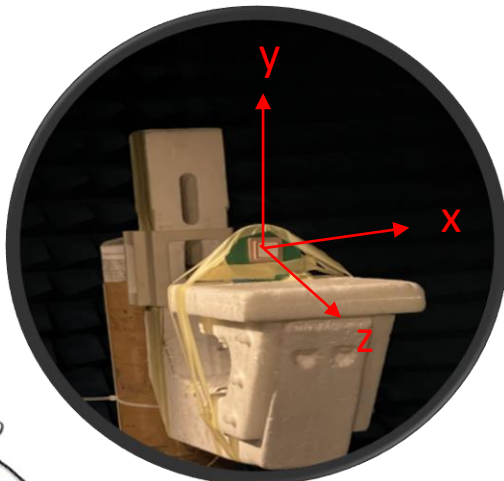

GPS L1 & L2 Ceramic Patch KYOCERA AVX Embedded Antenna Specifications.
 KYOCERA AVX produces a wide variety of standard and custom antennas to meet user needs

Mechanical Dimensions

Typical antenna dimensions (mm)

Part Number	A	B	C
9001002	38.0 ± 0.4	38.0 ± 0.4	8.16 ± 0.4

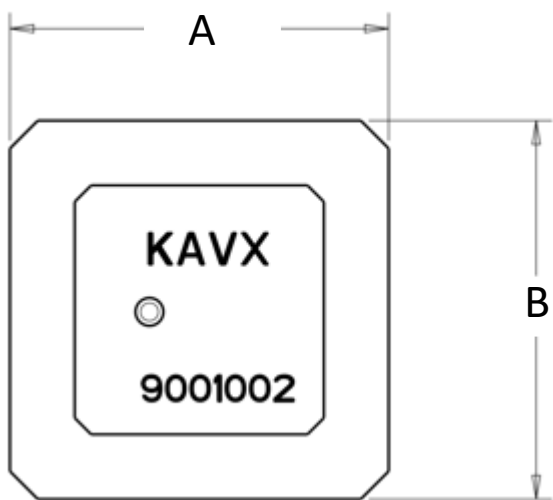

Top View

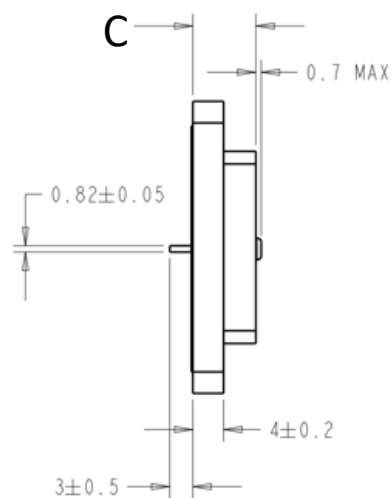

Side View

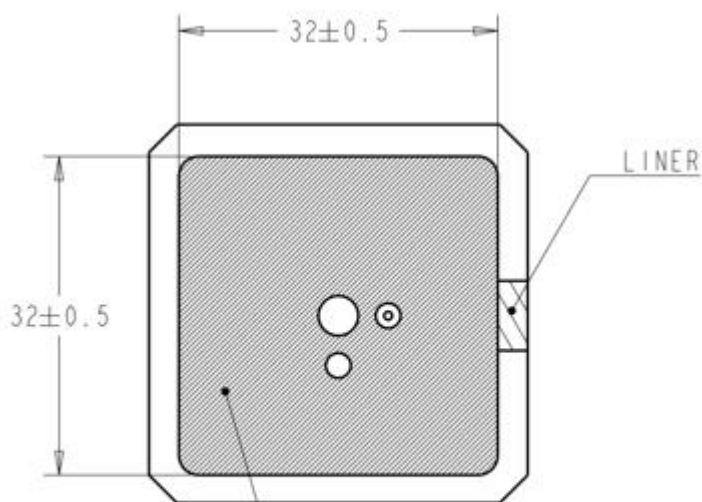

Bottom

ADHESIVE WITH LINER