

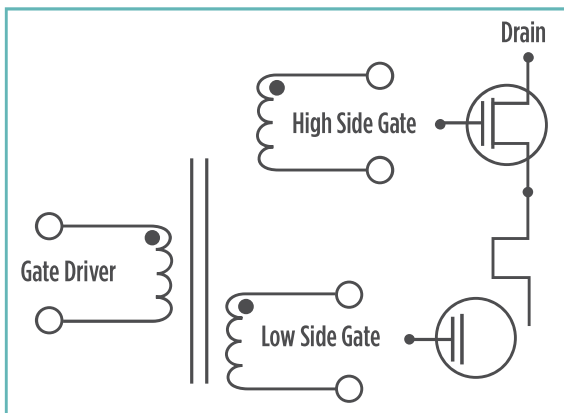

SMT ISOLATION TRANSFORMERS



High Side, Low Side H-Bridge





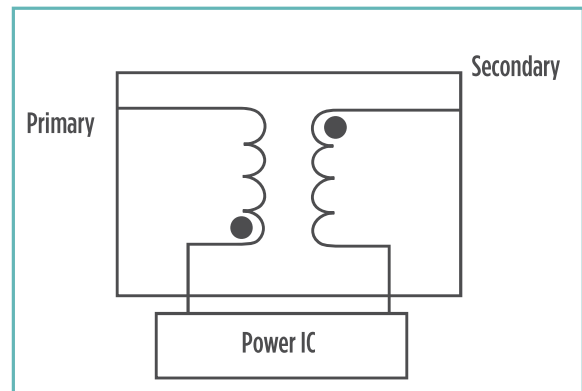



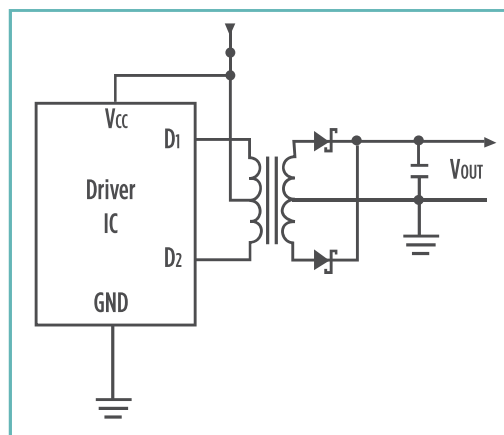











Flyback Isolation Transformer



Push-pull Isolation Transformer



	Dimensions			Series	Isolation Voltage (Hi-pot)	Insulation Type	UL Creepage Distance (Pri-Sec)	Volt-usec Rating (V-usec)	Topology	IATF
	L	W	H							
	6.6	5.8	5.3	PH9084	1500Vrms	Functional	-	28-37	Energy Transfer (schematic 1)	-
	7.1	6.1	5.5	PA2777	1500Vrms	Basic	1.4mm	9.3	Energy Transfer (schematic 4)	-
	8.0	6.6	5.3	P0926	1500Vdc	Functional	-	23	Energy Transfer (schematic 2)	-
	8.3	6.9	3.0	PG1427, PAG6658	2700Vdc	Functional Basic	2.8mm	21-30	Energy Transfer (schematic 3)	-
	8.6	6.7	2.5	PE-68386, PA2001	1500Vrms	Basic Functional	-	21-30	Energy Transfer (schematic 4)	-
	8.6	6.7	3.6	PA0264, PA2004	1000Vrms 1500Vrms"	Functional	-	12-20	Energy Transfer (schematic 2)	-
	9.5	7.1	5.3	PA1323	1500Vrms	Functional	-	21.7	Energy Transfer (schematic 4)	-
	10.2	7.5	11.0	PH9572, PH9572A PM9572, PM9572A	1500Vrms 2500Vrms	Functional Basic	12.0	42-84	Energy Transfer (schematic 1)	Yes
	9.5	8.1	5.1	PH9085, PM2180	2500Vrms	Functional	-	22-24	Energy Transfer (schematic 1)	Yes*
	10.5	9.0	6.5	PMT9085	3000Vrms	Reinforced	6.4mm	15-23	Energy Transfer (schematic 4)	Yes
	11.8	8.8	4.0	P0544, PA2002	"1500Vdc	Functional	1.4mm	45-60	Energy Transfer (schematic 2)	-
	11.8	8.8	4.0	PA0184, PA0297, PA0510, PA2007, PA2008, PA2009	1500Vrms	Basic	1.4mm	27-53	Energy Transfer (schematic 2)	-
	11.8	8.8	4.0	PA0173, PA0185 PA2005, PA2006	1500Vrms	Basic	1.4mm	17-26	Energy Transfer (schematic 2)	-
	10.9	9.7	2.7	PA3493	1650Vrms	Basic	1.4mm	21.7	Energy Transfer (schematic 4)	-
	10.0	10.0	12.5	PH9184	4000Vrms	Basic	4.0mm	200-296	Energy Transfer (schematic 1)	-
	10.0	10.0	12.5	PH9185, PM2190	5000Vrms	Reinforced	8.0mm	36-110	Energy Transfer (schematic 1)	Yes*
	10.5	10.3	12.5	PH9496	2500Vrms	Basic	6.2mm	-	Energy Transfer (schematic 4)	-
	9.2	12.5	7.6	PH9384, PM2185	4000Vrms	Reinforced	8.3mm	-	Energy Transfer (schematic 1)	Yes*
	13.0	10.0	12.5	PH0416, PM0416	5000Vrms	Reinforced	8.3mm	-	Energy Transfer (schematic 4)	Yes
	13.0	12.0	7.1	PH9363	2500Vrms	Basic	2.8mm	-	Energy Transfer (schematic 4)	-
	16.5	15.6	7.1	PH9385, PM2155 PAG6547, PMG6547	4000Vrms	Basic Reinforced	12.0mm	70-109	Energy Transfer (schematic 1)	Yes*
	16.7	16.5	14.2	PH9400, PH9400A	4000Vrms 5000Vrms	Basic Reinforced	12.0mm	125-375	Energy Transfer (schematic 1)	-

*See specific datasheet for details

Available Schematics
(multiple turns ratios available)

