

HARWIN

KONTROL

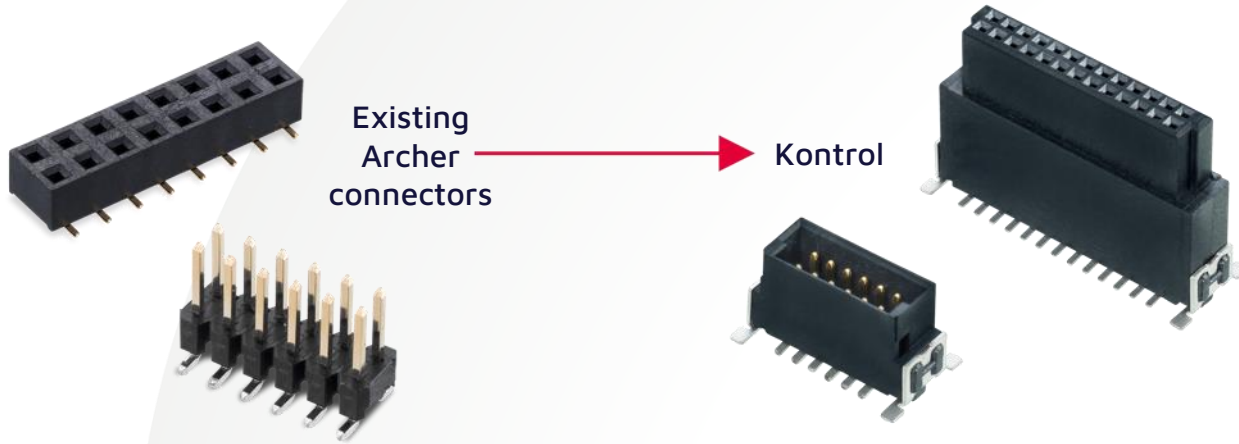

IMPROVED ROBUST PRODUCT RANGE



The choice of 1.27mm (0.05") pitch as an excellent alternative to 2.54mm (0.1") pitch is now well established. Many applications do not require the current-carrying load of the larger pitch, and the 50% space saving frees up a significant amount of space for other components or smaller units overall.

However, the demand for more robust electronics suitable for industrial markets is increasing. Connectors originally designed for consumer electronics now need to withstand the additional demands of the factory floor.

WIDE RANGE FOR DESIGN FLEXIBILITY

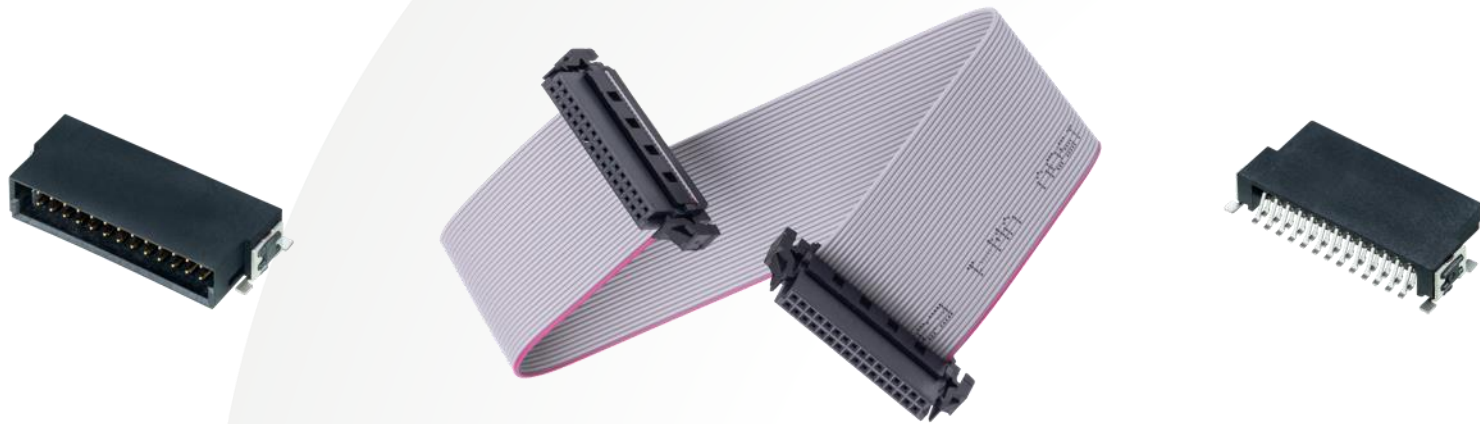

The [Kontrol](#) products are designed to occupy this mid-range requirement – better than previous consumer electronics, but not as high-end as true High-Reliability connectors such as [Gecko](#). Performance and reliability have been enhanced over a standard pin header and socket design, with the addition of a number of improved design features.

The connector range is compatible and intermateable with other standard connector ranges in the Industrial sector.

FEATURES – 3Gbit/s DATA RATE



By using insertion loss and Near End Cross Talk (NEXT) testing methods, a conservative estimate of the data rate for mated connectors is established at 3Gbit/s – at a level similar to SATA II.

Further information and test result graphs can be found in the [HT060xx Test Report Summary](#).

FEATURES – SHROUDING AND POLARIZATION

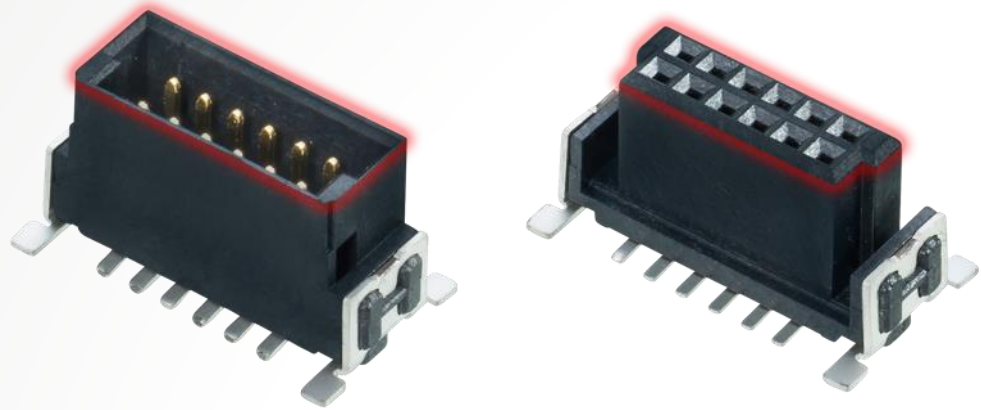

All connectors in this range feature fully shrouded and recessed contacts, to prevent accidental damage to the miniature contacts. The shrouding is also shaped to provide a positive polarization to enable assembly in only one direction.

These features assist with blind mating, where visibility during the mating action is obscured or absent.

FEATURES – SURFACE MOUNT RETENTION TABS AND PEGS

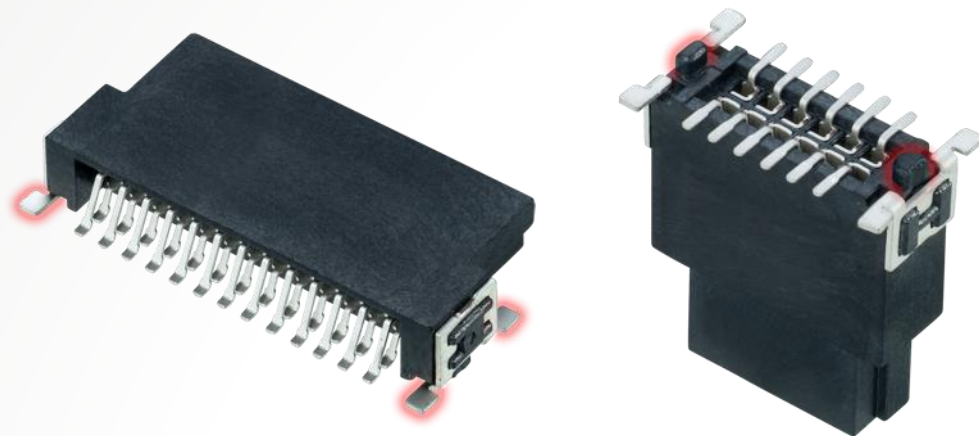

To assist with correct board placement, all connectors feature location pegs or posts to inhibit movement during the solder process.

To improve surface mount retention to the PCB, retention tabs are located on either end of the connectors which provide additional solder strength.

FEATURES – TOLERANCE TO MISALIGNMENT

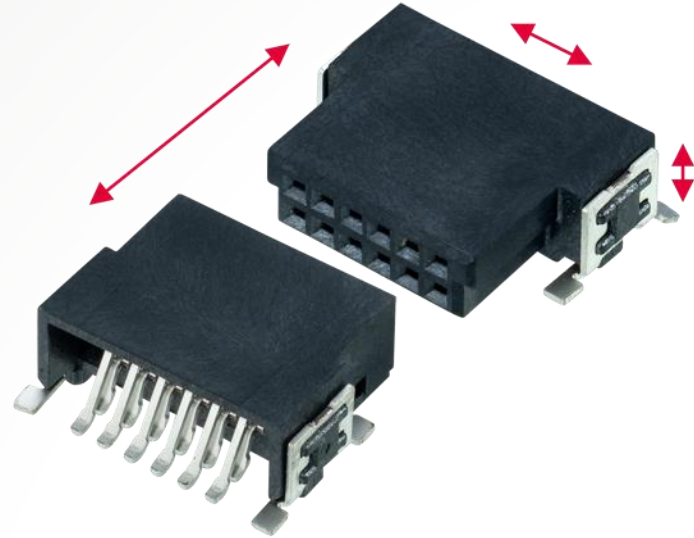

The female connector has a contact height at 1.45mm behind the mating face; the male pin is 4mm long. This gives a good tolerance to working at partially unmated conditions – the connectors will function with up to 1.5mm separation. In addition, the long twin beam design of the female connector and the chamfering of all front edges leads to tolerance to misalignment in all directions, including angled mating. The female contact design also assists in tolerance to vibration.

FEATURES – TOLERANCE TO MISALIGNMENT

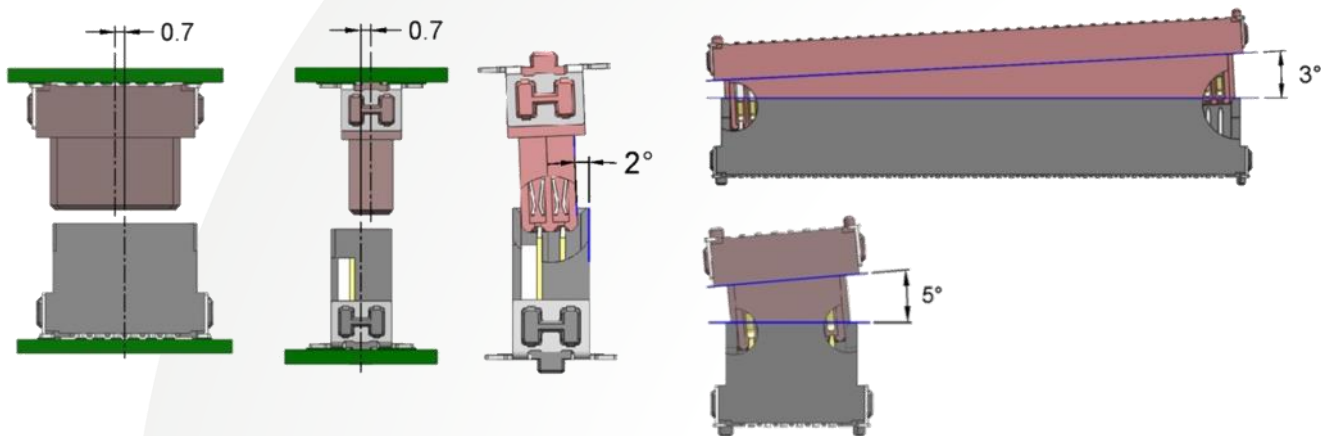

The above images show up to 0.7mm initial X and Y mating misalignment, with 2 degrees to 5 degrees angular misalignment (depending on the axis and number of contacts in the connector).

Final allowable mating misalignment (fully mated or up to 1.5mm separation) is 0.047mm in the X axis (along the connector length), and 0.043mm in the Y axis (across the connector).

READY FOR AUTO-PLACEMENT



All Male and Female SMT connectors are available in Tape and Reel packaging options, ready to facilitate automated assembly processes to the PCB.

The vertical connectors are fitted with disposable pick-and-place caps – for the horizontal connectors, there is already a suitable flat surface on the connector itself.

FEMALE DOUBLE ROW, SURFACE MOUNT

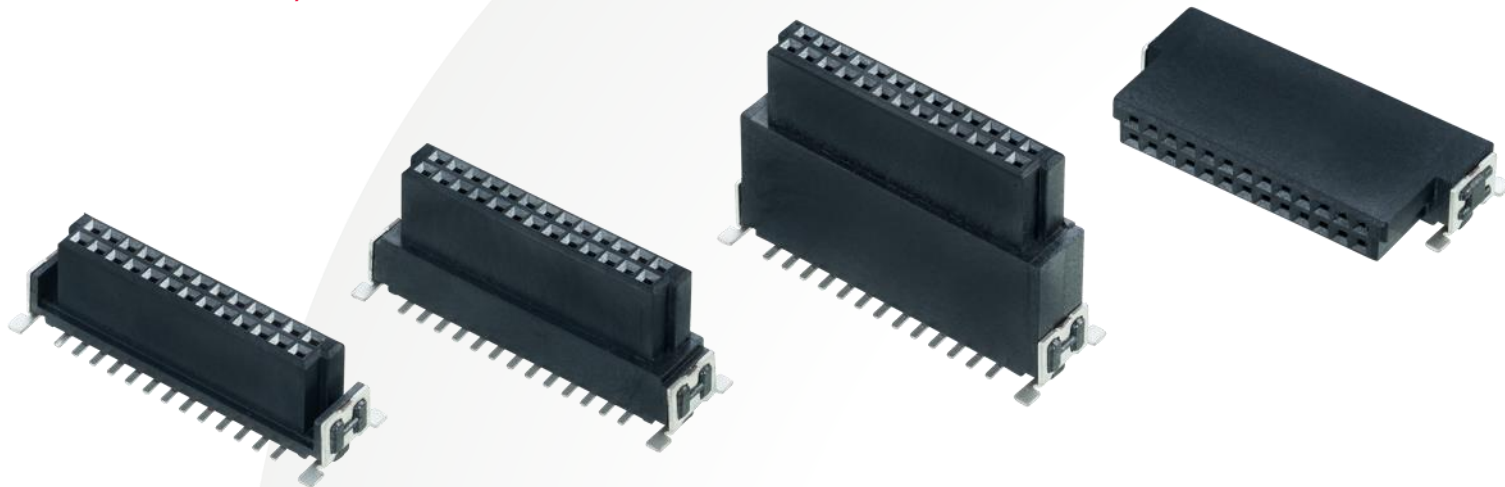

Available in three vertical heights and one horizontal connector, in selected sizes from 12 to 80 contacts (6+6 to 40+40).

Vertical connectors:

- 6.25mm height – [M55-600 series](#)
- 9.05mm height – [M55-601 series](#)
- 13.65mm height – [M55-602 series](#)

Horizontal connectors:

- [M55-610 series](#)

MALE DOUBLE ROW, SURFACE MOUNT

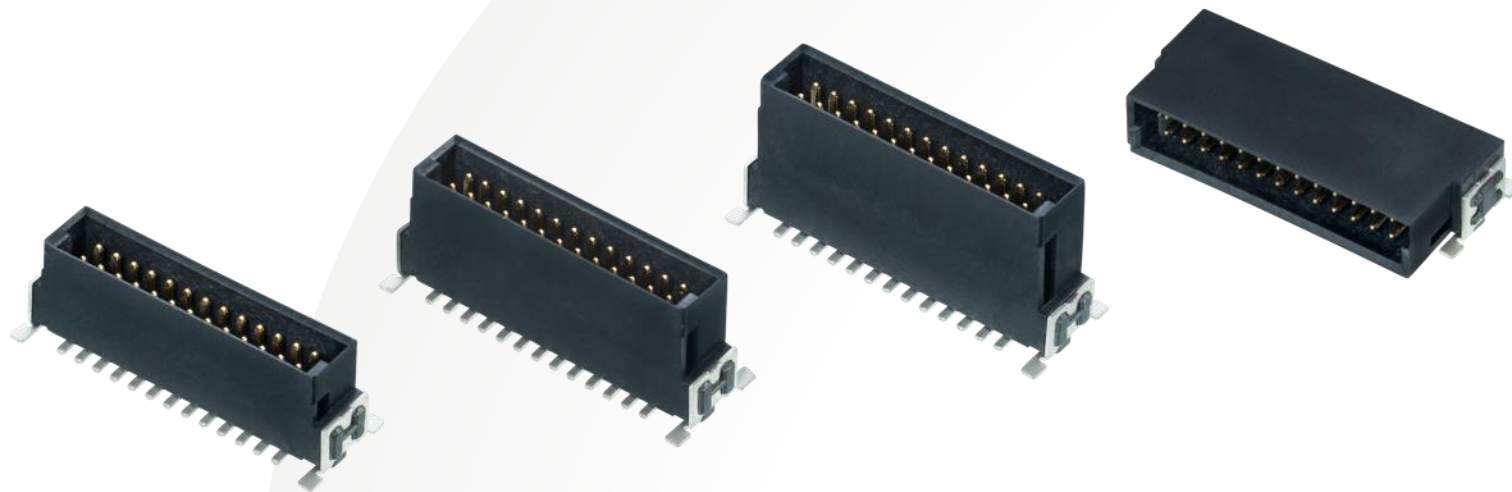

Also available in three vertical heights and one horizontal connector, in selected sizes from 12 to 80 contacts (6+6 to 40+40).

Vertical connectors:

- 6.75mm height – [M55-700 series](#)
- 8.25mm height – [M55-701 series](#)
- 9.85mm height – [M55-702 series](#)

Horizontal connectors:

- [M55-710 series](#)

BOARD-TO-BOARD MATING OPTIONS

			FEMALE			
			VERTICAL			HORIZONTAL
			6.25mm	9.05mm	13.65mm	
MALE	VERTICAL	6.75mm	8.00mm	10.80mm	15.40mm	12.55mm
		8.25mm	9.50mm	12.30mm	16.90mm	14.05mm
		9.85mm	11.10mm	13.90mm	18.50mm	15.65mm
	HORIZONTAL		11.25mm	14.05mm	18.65mm	15.80mm

Vertical to Vertical heights are the PCB-to-PCB mating face distances. For the mating heights involving horizontal connectors, the dimension is taken from the total footprint of the connector, i.e. the back edge of the SMT terminations. The dimensions given in the table are for the connectors fully mated – but the product will perform with up to 1.5mm separation, increasing the possible heights.

FEMALE CABLE ASSEMBLIES, DOUBLE ENDED

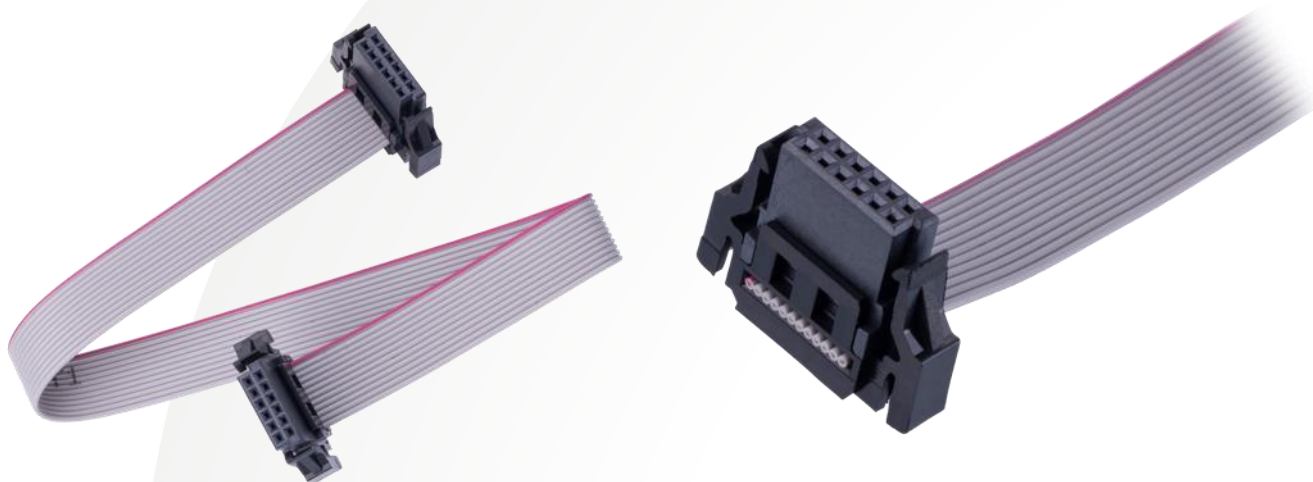

For cable to board connection, female-to-female cable assemblies are also available in the same selected sizes from 12 to 80 contacts (6+6 to 40+40). The cable length is available ready-made from stock at 150mm (6") and 300mm (12"), but other lengths can be custom-made on request (MOQs apply). UL-spec 30 AWG ribbon cable is attached via IDC to exit at right angles to the housing, and each female connector has integrated latching for additional strain relief. See [M55-800 series](#) connectors online.

FEMALE CABLE CONNECTORS

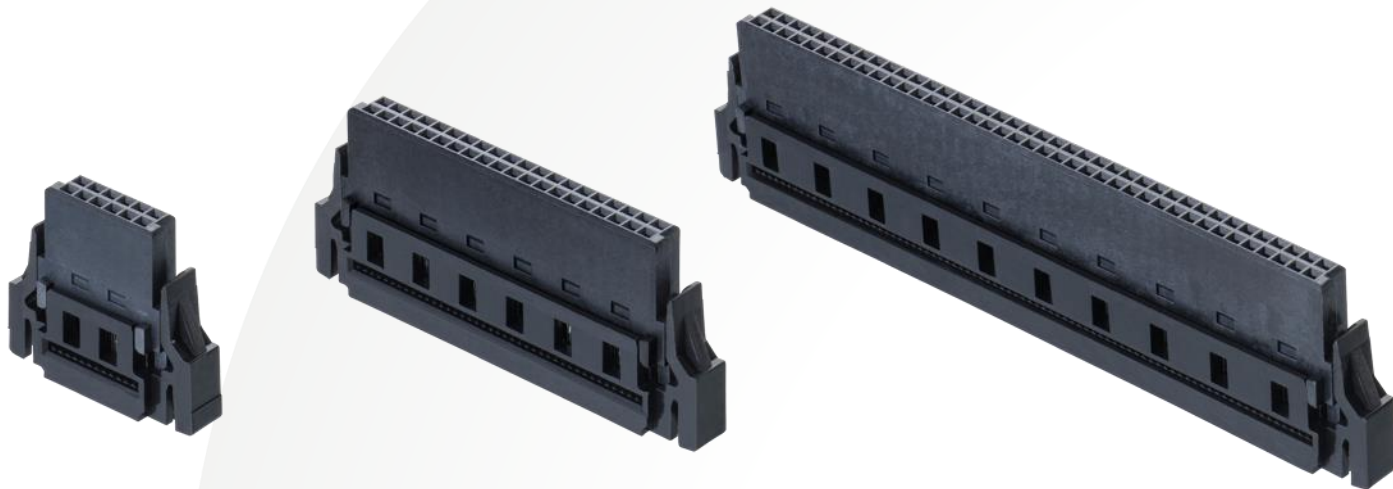

The female connectors from the cable assemblies are also available loose, so you can manufacture your own cable assemblies. See [M55-820 series](#) connectors and assembly tool [Z55-020](#) online.

Ribbon cable specification – we recommend UL2678 30 AWG at 0.635mm pitch.

ELECTRICAL SPECIFICATIONS

Current Rating	Board-to-Board = 1.2A max per contact Cable-to-Board = 0.5A max per contact
Contact Resistance	25mΩ max (initial)
Insulation Resistance	1,000MΩ min

The 1.2A current rating is higher than the normal current rating for the rest of the Archer range, typically rated to only 1A max.

View the [C047XX Component Specification](#) for more detail.

MECHANICAL & ENVIRONMENTAL SPECIFICATIONS

Durability	500 mating operations
Temperature Range	Board-to-Board = -55°C to +125°C Cable-to-Board = -20°C to +105°C
Vibration	20g for 12 hours (10 to 2,000Hz)

The temperature range for board-to-board connection is improved in comparison to conventional pin header and socket ranges, which normally offer only -40 to +105°C. The complete product range is manufactured using LCP housings, copper alloy contacts and retaining straps.

Maximum recommended solder temperature (soldering heat resistance) is 260°C for 10 seconds.

LEGISLATION – ENVIRONMENTALLY FRIENDLY MATERIAL



The materials used in the Kontrol connectors do not contain any Lead, Brominated Flame Retardants, Red Phosphor (PFOS/PFOA) or Antimony. They are fully RoHS Compatible and contain no REACH SVHCs.

MARKETS



The Kontrol range is ideally suited for the industrial environment, such as drives and controls. The combination of the enhanced durability and rugged design, with the miniature 1.27mm pitch, makes it convenient for both small and large-scale installations.

- Factory Equipment
- Monitoring Systems
- Trackside and Train
- Drives and Controls
- IOT Devices

Learn more about our other ranges



HIGH RELIABILITY
WITH SUPREME
PERFORMANCE



INNOVATIVE
DESIGNS FOR
EASY ASSEMBLY



DEPENDABLE
CONNECTIVITY
ACROSS THE BOARD

Find out more about our full range
of inter-connection solutions at

www.harwin.com

HRI
RANGE

EZI
RANGE

BBi
RANGE

Get Help from a Harwin Expert

Our experts are specialists in their field with many years of experience in their respective roles and industries.

Find an expert that can help you with your enquiry.

[Click Here >>](#)

CAD Models and Evaluation Samples also available at www.harwin.com



Contact Us

Europe, Middle East & Africa

T: +44 (0)23 9231 4545

E: technical@harwin.com

Americas

T: +1 603 893 5376

E: technical-us@harwin.com

Asia Pacific

T: +65 6 779 4909

E: technical-asia@harwin.com

WWW.HARWIN.COM