

Preliminary datasheet

EconoPIM™3 module with TRENCHSTOP™ IGBT7 and Emitter Controlled 7 diode and NTC

Features

- Electrical features
 - $V_{CES} = 1200\text{ V}$
 - $I_{C\text{nom}} = 200\text{ A} / I_{CRM} = 400\text{ A}$
 - TRENCHSTOP™ IGBT7
 - Overload operation up to 175°C
 - Low V_{CESat}
- Mechanical features
 - Integrated NTC temperature sensor
 - Solder contact technology
 - Copper base plate
 - Al_2O_3 substrate with low thermal resistance



Typical appearance

Potential applications

- Auxiliary inverters
- Motor drives
- Servo drives

Product validation

- Qualified for industrial applications according to the relevant tests of IEC 60747, 60749 and 60068

Description

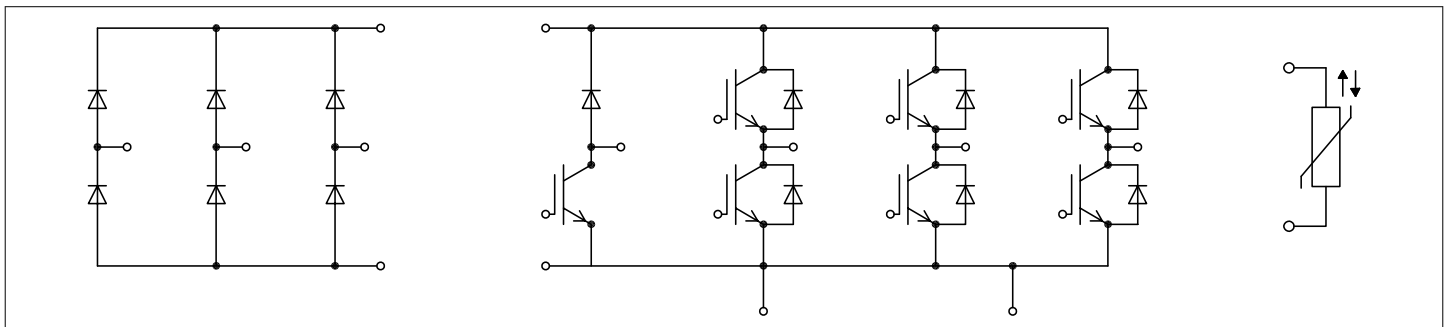

Table of contents

	Description	1
	Features	1
	Potential applications	1
	Product validation	1
	Table of contents	2
1	Package	3
2	IGBT, Inverter	3
3	Diode, Inverter	5
4	Diode, Rectifier	6
5	IGBT, Brake-Chopper	7
6	Diode, Brake-Chopper	8
7	NTC-Thermistor	9
8	Characteristics diagrams	11
9	Circuit diagram	17
10	Package outlines	18
11	Module label code	19
	Disclaimer	20

1 Package

1 Package

Table 1 Insulation coordination

Parameter	Symbol	Note or test condition	Values	Unit
Isolation test voltage	V_{ISOL}	RMS, $f = 50 \text{ Hz}$, $t = 1 \text{ min}$	2.5	kV
Material of module baseplate			Cu	
Internal Isolation		basic insulation (class 1, IEC 61140)	Al_2O_3	
Creepage distance	d_{Creep}	terminal to heatsink	10.0	mm
Clearance	d_{Clear}	terminal to heatsink	7.5	mm
Comparative tracking index	CTI		> 200	
RTI Elec.	RTI	housing	140	°C

Table 2 Characteristic values

Parameter	Symbol	Note or test condition	Values			Unit
			Min.	Typ.	Max.	
Stray inductance module	L_{SCE}			25		nH
Module lead resistance, terminals - chip	$R_{AA'+CC'}$	$T_C = 25^\circ\text{C}$, per switch		1.1		mΩ
Module lead resistance, terminals - chip	$R_{CC'+EE'}$	$T_C = 25^\circ\text{C}$, per switch		1.6		mΩ
Storage temperature	T_{stg}		-40		125	°C
Mounting torque for modul mounting	M	- Mounting according to valid application note	M5, Screw	3	6	Nm
Weight	G			300		g

Note: The current under continuous operation is limited to 50A rms per connector pin.

2 IGBT, Inverter

Table 3 Maximum rated values

Parameter	Symbol	Note or test condition	Values	Unit
Collector-emitter voltage	V_{CES}	$T_{vj} = 25^\circ\text{C}$	1200	V
Continous DC collector current	I_{CDC}	$T_{vj \text{ max}} = 175^\circ\text{C}$ $T_C = 70^\circ\text{C}$	200	A
Repetitive peak collector current	I_{CRM}	$t_p = 1 \text{ ms}$	400	A
Gate-emitter peak voltage	V_{GES}		±20	V

Table 4 Characteristic values

Parameter	Symbol	Note or test condition	Values			Unit	
			Min.	Typ.	Max.		
Collector-emitter saturation voltage	$V_{CE\ sat}$	$I_C = 200\ A, V_{GE} = 15\ V$	$T_{vj} = 25\ ^\circ C$		1.55	TBD	V
			$T_{vj} = 125\ ^\circ C$		1.69		
			$T_{vj} = 175\ ^\circ C$		1.77		
Gate threshold voltage	V_{GEth}	$I_C = 4.6\ mA, V_{CE} = V_{GE}, T_{vj} = 25\ ^\circ C$		5.15	5.80	6.45	V
Gate charge	Q_G	$V_{GE} = \pm 15\ V, V_{CE} = 600\ V$			3.34		μC
Internal gate resistor	R_{Gint}	$T_{vj} = 25\ ^\circ C$			0.75		Ω
Input capacitance	C_{ies}	$f = 100\ kHz, T_{vj} = 25\ ^\circ C, V_{CE} = 25\ V, V_{GE} = 0\ V$			40.3		nF
Reverse transfer capacitance	C_{res}	$f = 100\ kHz, T_{vj} = 25\ ^\circ C, V_{CE} = 25\ V, V_{GE} = 0\ V$			0.14		nF
Collector-emitter cut-off current	I_{CES}	$V_{CE} = 1200\ V, V_{GE} = 0\ V$	$T_{vj} = 25\ ^\circ C$			0.02	mA
Gate-emitter leakage current	I_{GES}	$V_{CE} = 0\ V, V_{GE} = 20\ V, T_{vj} = 25\ ^\circ C$				100	nA
Turn-on delay time (inductive load)	t_{don}	$I_C = 200\ A, V_{CE} = 600\ V, V_{GE} = \pm 15\ V, R_{Gon} = 2.7\ \Omega$	$T_{vj} = 25\ ^\circ C$		0.203		μs
			$T_{vj} = 125\ ^\circ C$		0.226		
			$T_{vj} = 175\ ^\circ C$		0.239		
Rise time (inductive load)	t_r	$I_C = 200\ A, V_{CE} = 600\ V, V_{GE} = \pm 15\ V, R_{Gon} = 2.7\ \Omega$	$T_{vj} = 25\ ^\circ C$		0.094		μs
			$T_{vj} = 125\ ^\circ C$		0.097		
			$T_{vj} = 175\ ^\circ C$		0.099		
Turn-off delay time (inductive load)	t_{doff}	$I_C = 200\ A, V_{CE} = 600\ V, V_{GE} = \pm 15\ V, R_{Goff} = 2.7\ \Omega$	$T_{vj} = 25\ ^\circ C$		0.351		μs
			$T_{vj} = 125\ ^\circ C$		0.414		
			$T_{vj} = 175\ ^\circ C$		0.433		
Fall time (inductive load)	t_f	$I_C = 200\ A, V_{CE} = 600\ V, V_{GE} = \pm 15\ V, R_{Goff} = 2.7\ \Omega$	$T_{vj} = 25\ ^\circ C$		0.103		μs
			$T_{vj} = 125\ ^\circ C$		0.198		
			$T_{vj} = 175\ ^\circ C$		0.262		
Turn-on energy loss per pulse	E_{on}	$I_C = 200\ A, V_{CE} = 600\ V, L_\sigma = 35\ nH, V_{GE} = \pm 15\ V, R_{Gon} = 2.7\ \Omega, di/dt = 2050\ A/\mu s (T_{vj} = 175\ ^\circ C)$	$T_{vj} = 25\ ^\circ C$		25.1		mJ
			$T_{vj} = 125\ ^\circ C$		38.3		
			$T_{vj} = 175\ ^\circ C$		45.9		
Turn-off energy loss per pulse	E_{off}	$I_C = 200\ A, V_{CE} = 600\ V, L_\sigma = 35\ nH, V_{GE} = \pm 15\ V, R_{Goff} = 2.7\ \Omega, dv/dt = 3250\ V/\mu s (T_{vj} = 175\ ^\circ C)$	$T_{vj} = 25\ ^\circ C$		12.9		mJ
			$T_{vj} = 125\ ^\circ C$		20.5		
			$T_{vj} = 175\ ^\circ C$		23.8		
SC data	I_{SC}	$V_{GE} \leq 15\ V, V_{CC} = 800\ V, V_{CEmax} = V_{CES} - L_{sCE} * di/dt$	$t_p \leq 8\ \mu s, T_{vj} = 150\ ^\circ C$		640		A
			$t_p \leq 7\ \mu s, T_{vj} = 175\ ^\circ C$		600		

Table 4 Characteristic values (continued)

Parameter	Symbol	Note or test condition	Values			Unit
			Min.	Typ.	Max.	
Thermal resistance, junction to case	R_{thJC}	per IGBT			0.231	K/W
Thermal resistance, case to heatsink	R_{thCH}	per IGBT, $\lambda_{grease} = 1 \text{ W}/(\text{m}^2\text{K})$		0.0670		K/W
Temperature under switching conditions	$T_{vj\text{ op}}$		-40		175	°C

Note: $T_{vj\text{ op}} > 150^\circ\text{C}$ is allowed for operation at overload conditions. For detailed specifications, please refer to AN 2018-14.

3 Diode, Inverter

Table 5 Maximum rated values

Parameter	Symbol	Note or test condition	Values	Unit	
Repetitive peak reverse voltage	V_{RRM}	$T_{vj} = 25^\circ\text{C}$	1200	V	
Continuous DC forward current	I_F		200	A	
Repetitive peak forward current	I_{FRM}	$t_P = 1 \text{ ms}$	400	A	
I^2t - value	I^2t	$t_P = 10 \text{ ms}, V_R = 0 \text{ V}$	$T_{vj} = 125^\circ\text{C}$	3700	A^2s
			$T_{vj} = 175^\circ\text{C}$	3050	

Table 6 Characteristic values

Parameter	Symbol	Note or test condition	Values			Unit	
			Min.	Typ.	Max.		
Forward voltage	V_F	$I_F = 200 \text{ A}, V_{GE} = 0 \text{ V}$	$T_{vj} = 25^\circ\text{C}$		1.72	TBD	V
			$T_{vj} = 125^\circ\text{C}$		1.59		
			$T_{vj} = 175^\circ\text{C}$		1.52		
Peak reverse recovery current	I_{RM}	$V_R = 600 \text{ V}, I_F = 200 \text{ A}, V_{GE} = -15 \text{ V}, -di_F/dt = 2050 \text{ A}/\mu\text{s} (T_{vj} = 175^\circ\text{C})$	$T_{vj} = 25^\circ\text{C}$		79.6		A
			$T_{vj} = 125^\circ\text{C}$		105		
			$T_{vj} = 175^\circ\text{C}$		118		
Recovered charge	Q_r	$V_R = 600 \text{ V}, I_F = 200 \text{ A}, V_{GE} = -15 \text{ V}, -di_F/dt = 2050 \text{ A}/\mu\text{s} (T_{vj} = 175^\circ\text{C})$	$T_{vj} = 25^\circ\text{C}$		15.7		μC
			$T_{vj} = 125^\circ\text{C}$		27.7		
			$T_{vj} = 175^\circ\text{C}$		35.6		

Table 6 Characteristic values (continued)

Parameter	Symbol	Note or test condition	Values			Unit
			Min.	Typ.	Max.	
Reverse recovery energy	E_{rec}	$V_R = 600\text{ V}$, $I_F = 200\text{ A}$, $V_{GE} = -15\text{ V}$, $-di_F/dt = 2050\text{ A}/\mu\text{s}$ ($T_{vj} = 175\text{ °C}$)	$T_{vj} = 25\text{ °C}$	4.85		mJ
			$T_{vj} = 125\text{ °C}$	9.64		
			$T_{vj} = 175\text{ °C}$	12.2		
Thermal resistance, junction to case	R_{thJC}	per diode			0.376	K/W
Thermal resistance, case to heatsink	R_{thCH}	per diode, $\lambda_{grease} = 1\text{ W}/(\text{m}^*\text{K})$		0.0730		K/W
Temperature under switching conditions	$T_{vj\text{ op}}$		-40		175	°C

Note: $T_{vj\text{ op}} > 150\text{ °C}$ is allowed for operation at overload conditions. For detailed specifications, please refer to AN 2018-14.

4 Diode, Rectifier

Table 7 Maximum rated values

Parameter	Symbol	Note or test condition	Values	Unit	
Repetitive peak reverse voltage	V_{RRM}	$T_{vj} = 25\text{ °C}$	1600	V	
Maximum RMS forward current per chip	I_{FRMSM}	$T_C = 110\text{ °C}$	150	A	
Maximum RMS current at rectifier output	I_{RMSM}	$T_C = 110\text{ °C}$	150	A	
Surge forward current	I_{FSM}	$t_p = 10\text{ ms}$	$T_{vj} = 25\text{ °C}$	1800	A
			$T_{vj} = 150\text{ °C}$	1600	
I^2t - value	I^2t	$t_p = 10\text{ ms}$	$T_{vj} = 25\text{ °C}$	16200	A^2s
			$T_{vj} = 150\text{ °C}$	12800	

Table 8 Characteristic values

Parameter	Symbol	Note or test condition	Values			Unit
			Min.	Typ.	Max.	
Forward voltage	V_F	$I_F = 200\text{ A}$, $T_{vj} = 150\text{ °C}$		1.01		V
Reverse current	I_r	$T_{vj} = 150\text{ °C}$, $V_R = 1600\text{ V}$		1.4		mA
Thermal resistance, junction to case	R_{thJC}	per diode			0.278	K/W
Thermal resistance, case to heatsink	R_{thCH}	per diode, $\lambda_{grease} = 1\text{ W}/(\text{m}^*\text{K})$		0.0690		K/W

Table 8 Characteristic values (continued)

Parameter	Symbol	Note or test condition	Values			Unit
			Min.	Typ.	Max.	
Temperature under switching conditions	$T_{vj, op}$		-40		150	°C

5 IGBT, Brake-Chopper

Table 9 Maximum rated values

Parameter	Symbol	Note or test condition	Values	Unit
Collector-emitter voltage	V_{CES}	$T_{vj} = 25\text{ °C}$	1200	V
Continuous DC collector current	I_{CDC}	$T_{vj\ max} = 175\text{ °C}$ $T_C = 75\text{ °C}$	150	A
Repetitive peak collector current	I_{CRM}	$t_p = 1\text{ ms}$	300	A
Gate-emitter peak voltage	V_{GES}		±20	V

Table 10 Characteristic values

Parameter	Symbol	Note or test condition	Values			Unit
			Min.	Typ.	Max.	
Collector-emitter saturation voltage	$V_{CE\ sat}$	$I_C = 150\text{ A}, V_{GE} = 15\text{ V}$	$T_{vj} = 25\text{ °C}$	1.55	TBD	V
			$T_{vj} = 125\text{ °C}$	1.69		
			$T_{vj} = 175\text{ °C}$	1.77		
Gate threshold voltage	V_{GEth}	$I_C = 3.5\text{ mA}, V_{CE} = V_{GE}, T_{vj} = 25\text{ °C}$	5.15	5.80	6.45	V
Gate charge	Q_G	$V_{GE} = \pm 15\text{ V}, V_{CE} = 600\text{ V}$		2.5		μC
Internal gate resistor	R_{Gint}	$T_{vj} = 25\text{ °C}$		1		Ω
Input capacitance	C_{ies}	$f = 100\text{ kHz}, T_{vj} = 25\text{ °C}, V_{CE} = 25\text{ V}, V_{GE} = 0\text{ V}$		30.1		nF
Reverse transfer capacitance	C_{res}	$f = 100\text{ kHz}, T_{vj} = 25\text{ °C}, V_{CE} = 25\text{ V}, V_{GE} = 0\text{ V}$		0.105		nF
Collector-emitter cut-off current	I_{CES}	$V_{CE} = 1200\text{ V}, V_{GE} = 0\text{ V}$			0.005	mA
Gate-emitter leakage current	I_{GES}	$V_{CE} = 0\text{ V}, V_{GE} = 20\text{ V}, T_{vj} = 25\text{ °C}$			100	nA
Turn-on delay time (inductive load)	t_{don}	$I_C = 150\text{ A}, V_{CE} = 600\text{ V}, V_{GE} = \pm 15\text{ V}, R_{Gon} = 5.6\text{ }\Omega$	$T_{vj} = 25\text{ °C}$	0.197		μs
			$T_{vj} = 125\text{ °C}$	0.208		
			$T_{vj} = 175\text{ °C}$	0.215		
Rise time (inductive load)	t_r	$I_C = 150\text{ A}, V_{CE} = 600\text{ V}, V_{GE} = \pm 15\text{ V}, R_{Gon} = 5.6\text{ }\Omega$	$T_{vj} = 25\text{ °C}$	0.085		μs
			$T_{vj} = 125\text{ °C}$	0.090		
			$T_{vj} = 175\text{ °C}$	0.093		

Table 10 Characteristic values (continued)

Parameter	Symbol	Note or test condition	Values			Unit
			Min.	Typ.	Max.	
Turn-off delay time (inductive load)	t_{doff}	$I_C = 150\text{ A}, V_{CE} = 600\text{ V}, V_{GE} = \pm 15\text{ V}, R_{Goff} = 5.6\ \Omega$	$T_{vj} = 25\text{ }^\circ\text{C}$	0.419		μs
			$T_{vj} = 125\text{ }^\circ\text{C}$	0.502		
			$T_{vj} = 175\text{ }^\circ\text{C}$	0.521		
Fall time (inductive load)	t_f	$I_C = 150\text{ A}, V_{CE} = 600\text{ V}, V_{GE} = \pm 15\text{ V}, R_{Goff} = 5.6\ \Omega$	$T_{vj} = 25\text{ }^\circ\text{C}$	0.113		μs
			$T_{vj} = 125\text{ }^\circ\text{C}$	0.208		
			$T_{vj} = 175\text{ }^\circ\text{C}$	0.272		
Turn-on energy loss per pulse	E_{on}	$I_C = 150\text{ A}, V_{CE} = 600\text{ V}, L_\sigma = 35\text{ nH}, V_{GE} = \pm 15\text{ V}, R_{Gon} = 5.6\ \Omega, di/dt = 1150\text{ A}/\mu\text{s} (T_{vj} = 175\text{ }^\circ\text{C})$	$T_{vj} = 25\text{ }^\circ\text{C}$	12.2		mJ
			$T_{vj} = 125\text{ }^\circ\text{C}$	19.1		
			$T_{vj} = 175\text{ }^\circ\text{C}$	23.1		
Turn-off energy loss per pulse	E_{off}	$I_C = 150\text{ A}, V_{CE} = 600\text{ V}, L_\sigma = 35\text{ nH}, V_{GE} = \pm 15\text{ V}, R_{Goff} = 5.6\ \Omega, dv/dt = 3100\text{ V}/\mu\text{s} (T_{vj} = 175\text{ }^\circ\text{C})$	$T_{vj} = 25\text{ }^\circ\text{C}$	10.5		mJ
			$T_{vj} = 125\text{ }^\circ\text{C}$	16.1		
			$T_{vj} = 175\text{ }^\circ\text{C}$	20.1		
SC data	I_{SC}	$V_{GE} \leq 15\text{ V}, V_{CC} = 800\text{ V}, V_{CEmax} = V_{CES} - L_{SCE} \cdot di/dt$	$t_p \leq 8\ \mu\text{s}, T_{vj} = 150\text{ }^\circ\text{C}$	480		A
			$t_p \leq 7\ \mu\text{s}, T_{vj} = 175\text{ }^\circ\text{C}$	450		
Thermal resistance, junction to case	R_{thJC}	per IGBT			0.290	K/W
Thermal resistance, case to heatsink	R_{thCH}	per IGBT, $\lambda_{grease} = 1\text{ W}/(\text{m}^2\text{K})$		0.0700		K/W
Temperature under switching conditions	T_{vjop}		-40		175	$^\circ\text{C}$

Note: $T_{vjop} > 150\text{ }^\circ\text{C}$ is allowed for operation at overload conditions. For detailed specifications, please refer to AN 2018-14.

6 Diode, Brake-Chopper

Table 11 Maximum rated values

Parameter	Symbol	Note or test condition	Values	Unit
Repetitive peak reverse voltage	V_{RRM}	$T_{vj} = 25\text{ }^\circ\text{C}$	1200	V
Continuous DC forward current	I_F		75	A
Repetitive peak forward current	I_{FRM}	$t_p = 1\text{ ms}$	150	A

Table 11 Maximum rated values (continued)

Parameter	Symbol	Note or test condition	Values			Unit
			Min.	Typ.	Max.	
I ² t - value	I ² t	t _p = 10 ms, V _R = 0 V	T _{vj} = 125 °C	450		A ² s
			T _{vj} = 175 °C	370		

Table 12 Characteristic values

Parameter	Symbol	Note or test condition	Values			Unit
			Min.	Typ.	Max.	
Forward voltage	V _F	I _F = 75 A, V _{GE} = 0 V	T _{vj} = 25 °C	1.72	TBD	V
			T _{vj} = 125 °C	1.59		
			T _{vj} = 175 °C	1.52		
Peak reverse recovery current	I _{RM}	V _R = 600 V, I _F = 75 A, V _{GE} = -15 V, -di _F /dt = 1050 A/μs (T _{vj} = 175 °C)	T _{vj} = 25 °C	38.2		A
			T _{vj} = 125 °C	50.9		
			T _{vj} = 175 °C	58.9		
Recovered charge	Q _r	V _R = 600 V, I _F = 75 A, V _{GE} = -15 V, -di _F /dt = 1050 A/μs (T _{vj} = 175 °C)	T _{vj} = 25 °C	5.43		μC
			T _{vj} = 125 °C	10.4		
			T _{vj} = 175 °C	14.1		
Reverse recovery energy	E _{rec}	V _R = 600 V, I _F = 75 A, V _{GE} = -15 V, -di _F /dt = 1050 A/μs (T _{vj} = 175 °C)	T _{vj} = 25 °C	10		mJ
			T _{vj} = 125 °C	10		
			T _{vj} = 175 °C	10		
Thermal resistance, junction to case	R _{thJC}	per diode			0.728	K/W
Thermal resistance, case to heatsink	R _{thCH}	per diode, λ _{grease} = 1 W/(m*K)		0.0870		K/W
Temperature under switching conditions	T _{vj op}		-40		175	°C

Note: T_{vj op} > 150°C is allowed for operation at overload conditions. For detailed specifications, please refer to AN 2018-14.

7 NTC-Thermistor

Table 13 Characteristic values

Parameter	Symbol	Note or test condition	Values			Unit
			Min.	Typ.	Max.	
Rated resistance	R ₂₅	T _{NTC} = 25 °C		5		kΩ
Deviation of R ₁₀₀	ΔR/R	T _{NTC} = 100 °C, R ₁₀₀ = 493 Ω	-5		5	%
Power dissipation	P ₂₅	T _{NTC} = 25 °C			20	mW

Table 13 **Characteristic values (continued)**

Parameter	Symbol	Note or test condition	Values			Unit
			Min.	Typ.	Max.	
B-value	$B_{25/50}$	$R_2 = R_{25} \exp[B_{25/50}(1/T_2 - 1/(298,15 \text{ K}))]$		3375		K
B-value	$B_{25/80}$	$R_2 = R_{25} \exp[B_{25/80}(1/T_2 - 1/(298,15 \text{ K}))]$		3411		K
B-value	$B_{25/100}$	$R_2 = R_{25} \exp[B_{25/100}(1/T_2 - 1/(298,15 \text{ K}))]$		3433		K

Note: *Specification according to the valid application note.*

8 Characteristics diagrams

output characteristic (typical), IGBT, Inverter

$I_C = f(V_{CE})$
 $V_{GE} = 15 \text{ V}$

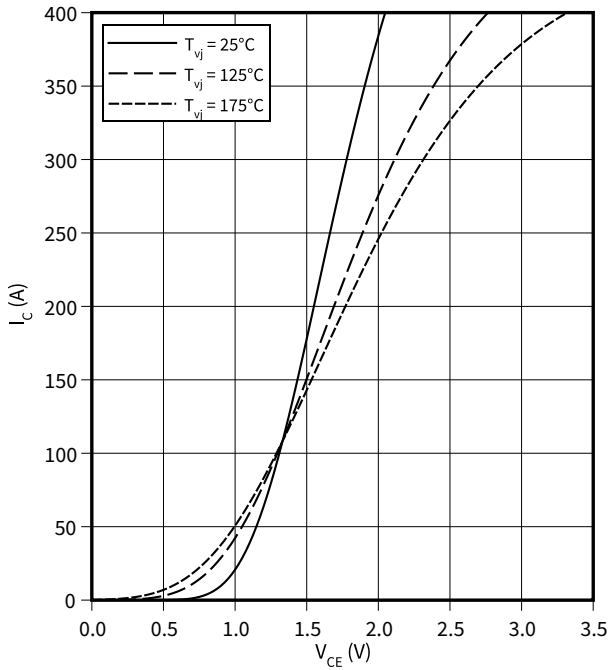

output characteristic (typical), IGBT, Inverter

$I_C = f(V_{CE})$
 $T_{vj} = 175 \text{ °C}$

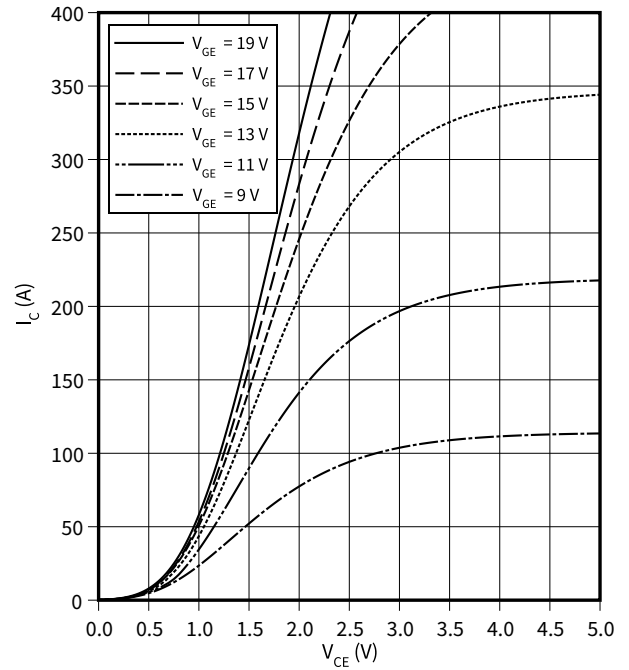

transfer characteristic (typical), IGBT, Inverter

$I_C = f(V_{GE})$
 $V_{CE} = 20 \text{ V}$

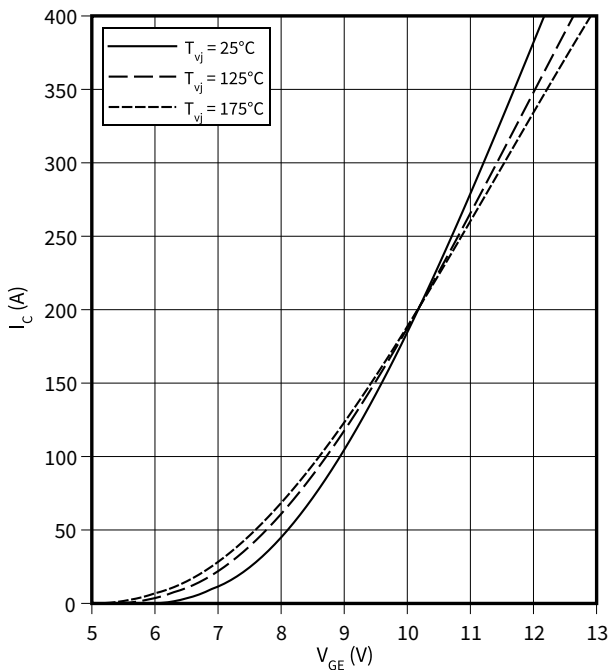

switching losses (typical), IGBT, Inverter

$E = f(I_C)$
 $R_{Goff} = 2.7 \text{ } \Omega$, $R_{Gon} = 2.7 \text{ } \Omega$, $V_{CE} = 600 \text{ V}$, $V_{GE} = \pm 15 \text{ V}$

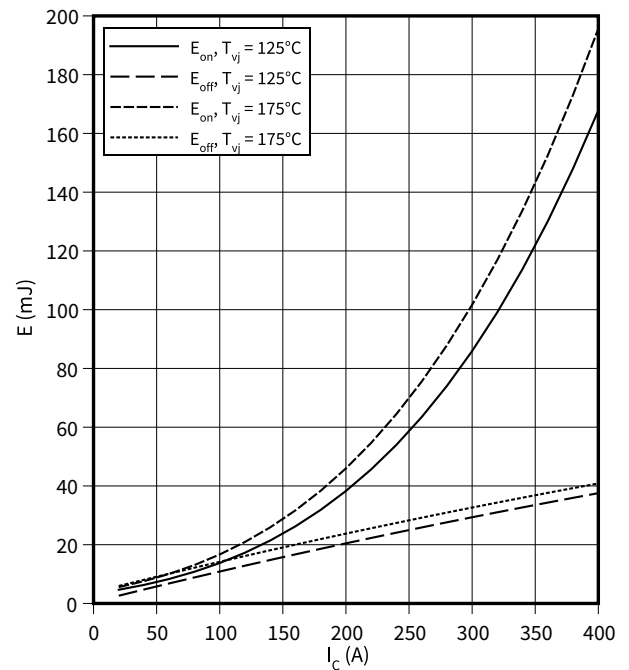

8 Characteristics diagrams

switching losses (typical), IGBT, Inverter

$E = f(R_G)$

$I_C = 200 \text{ A}$, $V_{CE} = 600 \text{ V}$, $V_{GE} = \pm 15 \text{ V}$

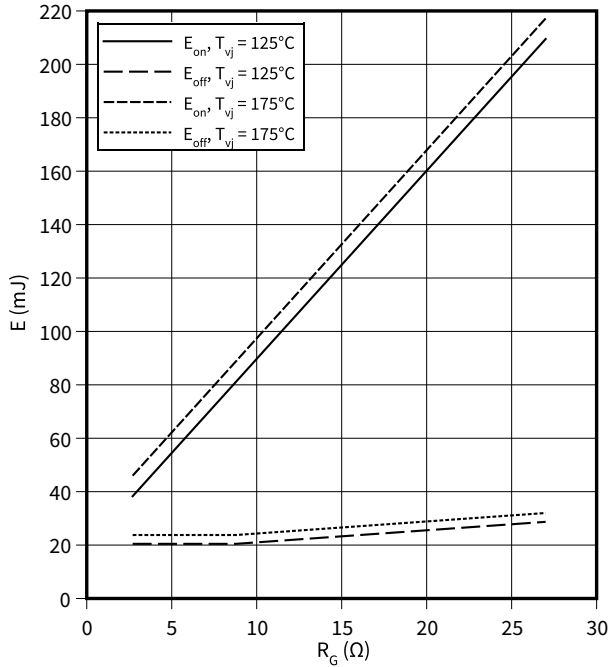

switching times (typical), IGBT, Inverter

$t = f(I_C)$

$R_{Goff} = 2.7 \Omega$, $R_{Gon} = 2.7 \Omega$, $V_{CE} = 600 \text{ V}$, $V_{GE} = \pm 15 \text{ V}$, $T_{vj} = 175 \text{ °C}$

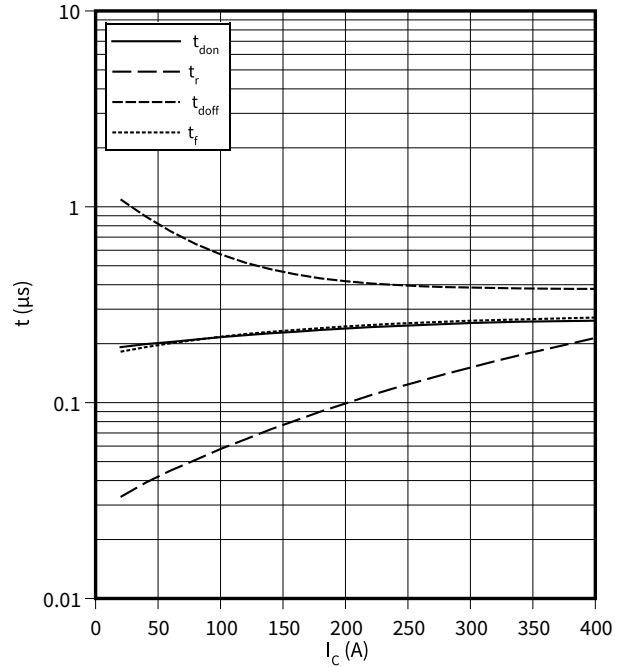

switching times (typical), IGBT, Inverter

$t = f(R_G)$

$I_C = 200 \text{ A}$, $V_{CE} = 600 \text{ V}$, $V_{GE} = \pm 15 \text{ V}$, $T_{vj} = 175 \text{ °C}$

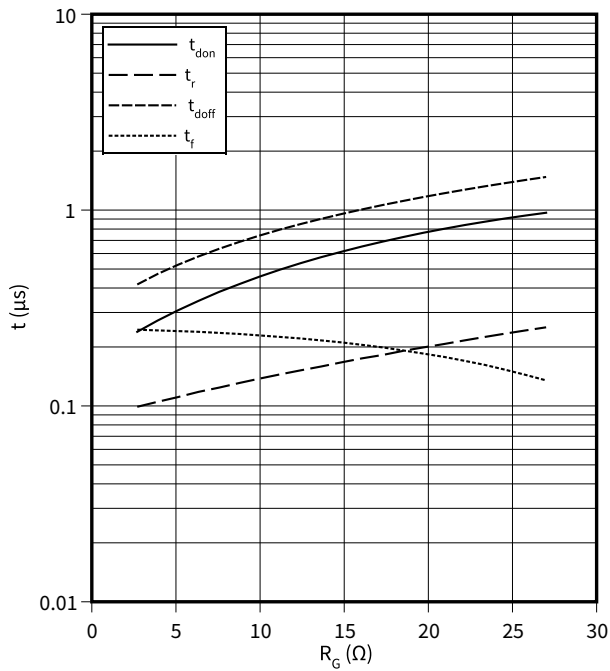

transient thermal impedance, IGBT, Inverter

$Z_{th} = f(t)$

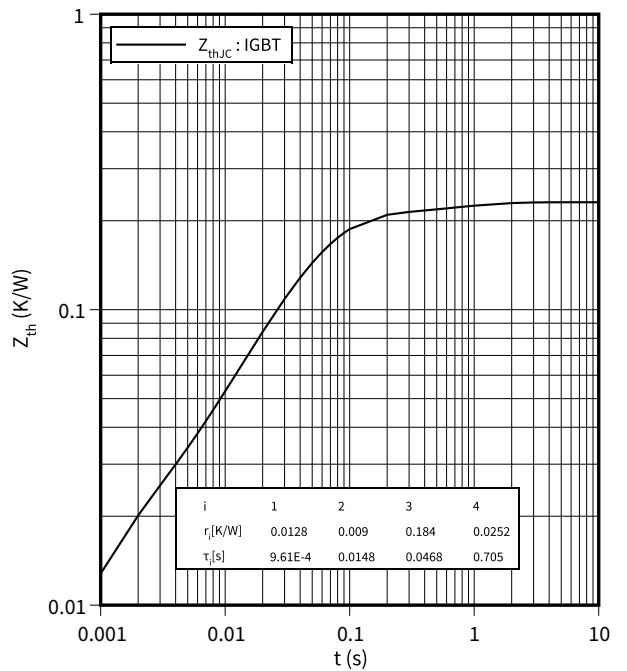

8 Characteristics diagrams

Voltage slope (typical), IGBT, Inverter

$dv/dt = f(R_G)$

$I_C = 200 \text{ A}$, $V_{CE} = 600 \text{ V}$, $V_{GE} = \pm 15 \text{ V}$, $T_{vj} = 25 \text{ }^\circ\text{C}$

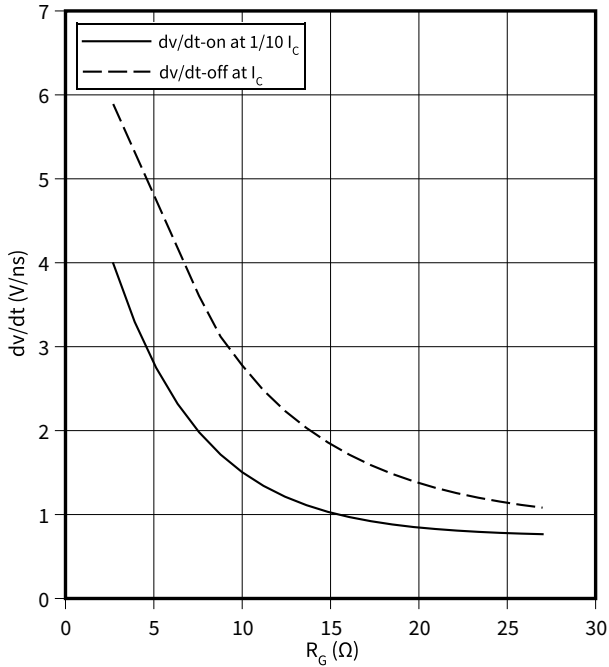

reverse bias safe operating area (RBSOA), IGBT, Inverter

$I_C = f(V_{CE})$

$R_{Goff} = 2.7 \text{ } \Omega$, $V_{GE} = \pm 15 \text{ V}$, $T_{vj} = 175 \text{ }^\circ\text{C}$

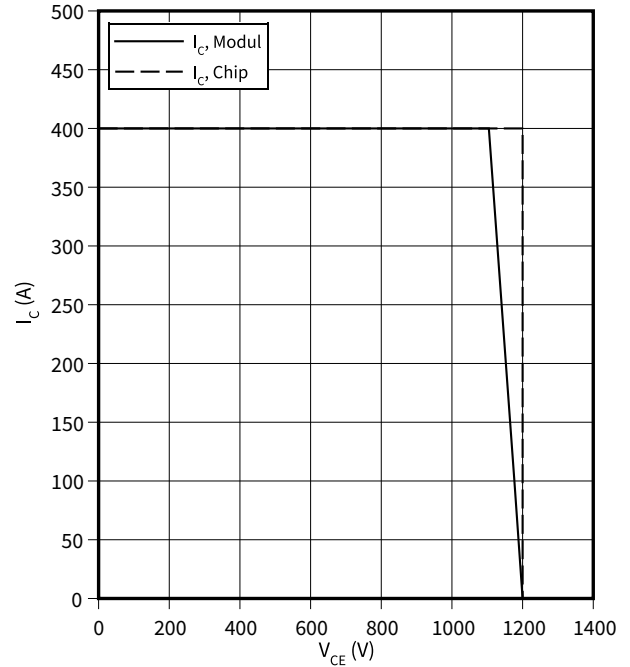

capacity characteristic (typical), IGBT, Inverter

$C = f(V_{CE})$

$f = 100 \text{ kHz}$, $V_{GE} = 0 \text{ V}$, $T_{vj} = 25 \text{ }^\circ\text{C}$

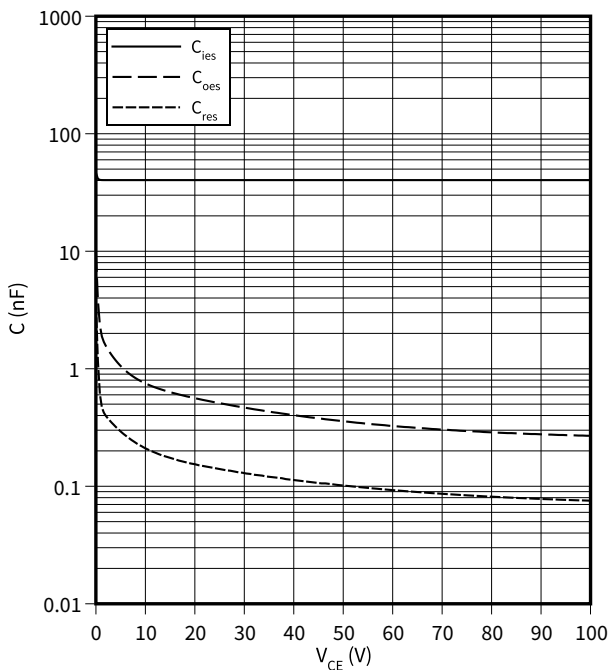

gate charge characteristic (typical), IGBT, Inverter

$V_{GE} = f(Q_G)$

$I_C = 200 \text{ A}$, $T_{vj} = 25 \text{ }^\circ\text{C}$

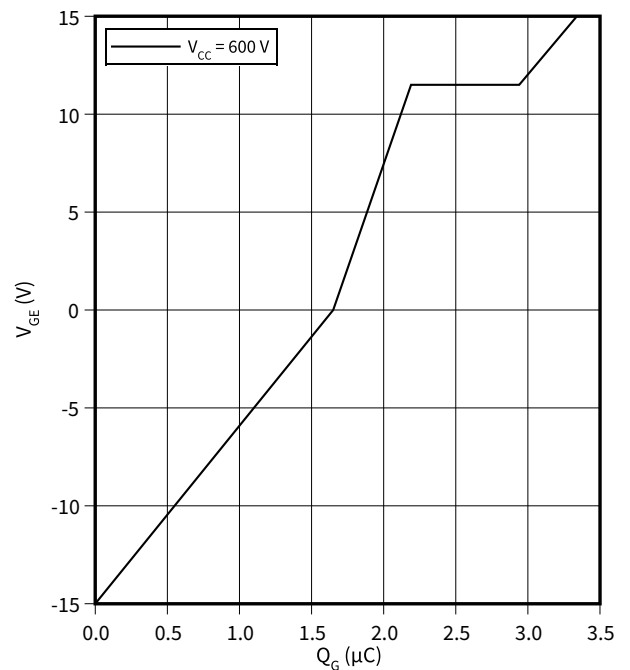

8 Characteristics diagrams

forward characteristic (typical), Diode, Inverter

$I_F = f(V_F)$

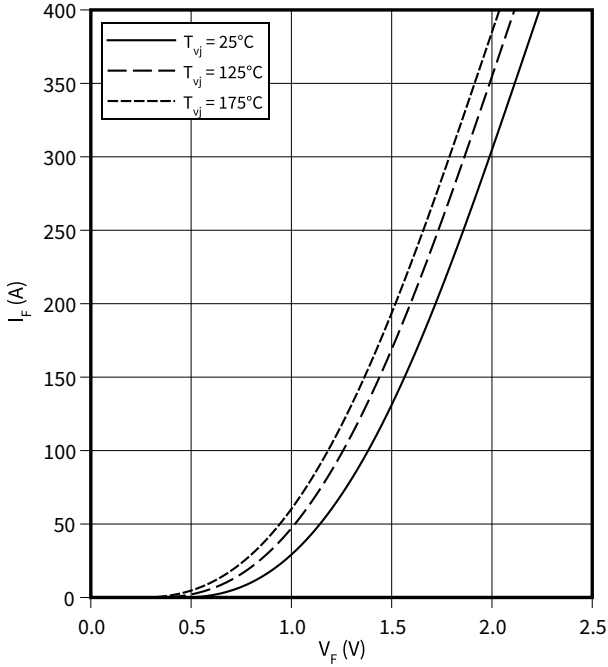

switching losses (typical), Diode, Inverter

$E_{rec} = f(I_F)$

$R_{Gon} = 2.7 \Omega, V_{CE} = 600 V$

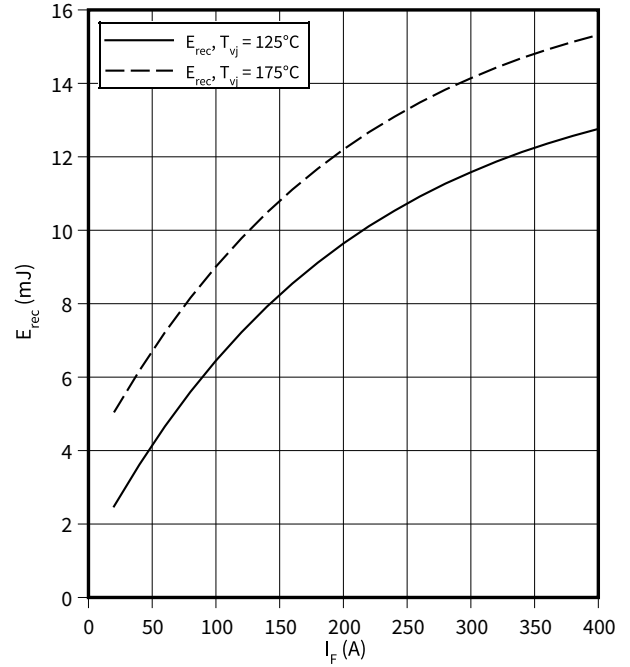

switching losses (typical), Diode, Inverter

$E_{rec} = f(R_G)$

$V_{CE} = 600 V, I_F = 200 A$

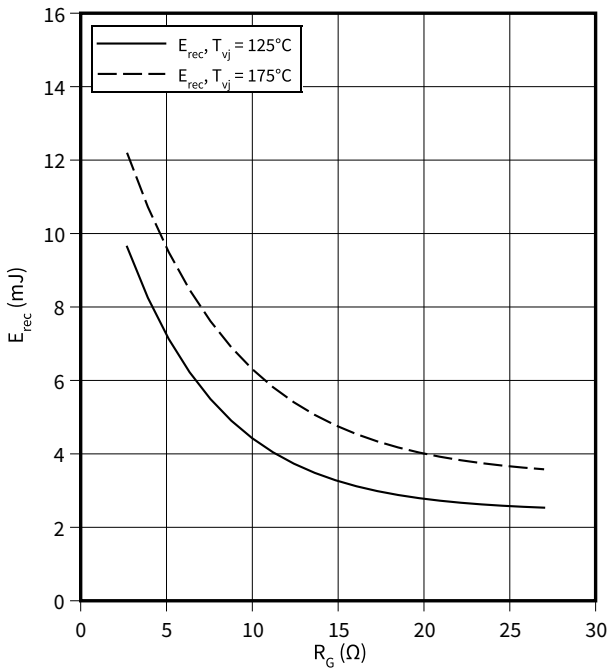

transient thermal impedance, Diode, Inverter

$Z_{th} = f(t)$

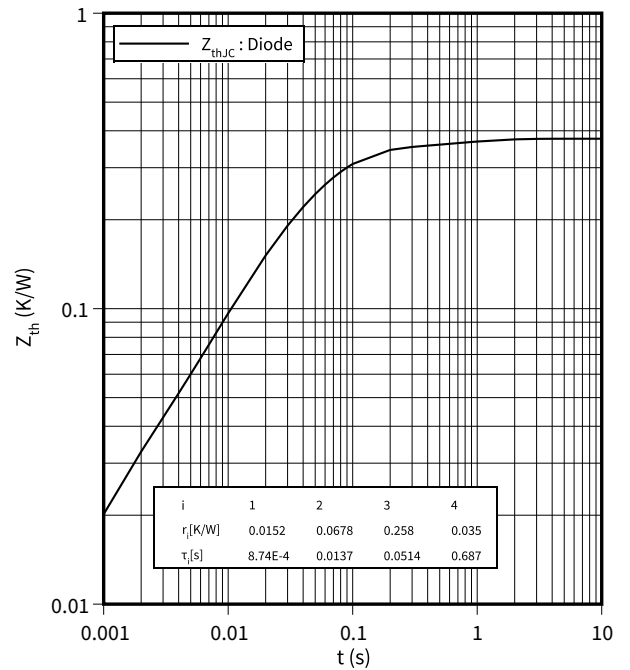

8 Characteristics diagrams

forward characteristic (typical), Diode, Rectifier

$I_F = f(V_F)$

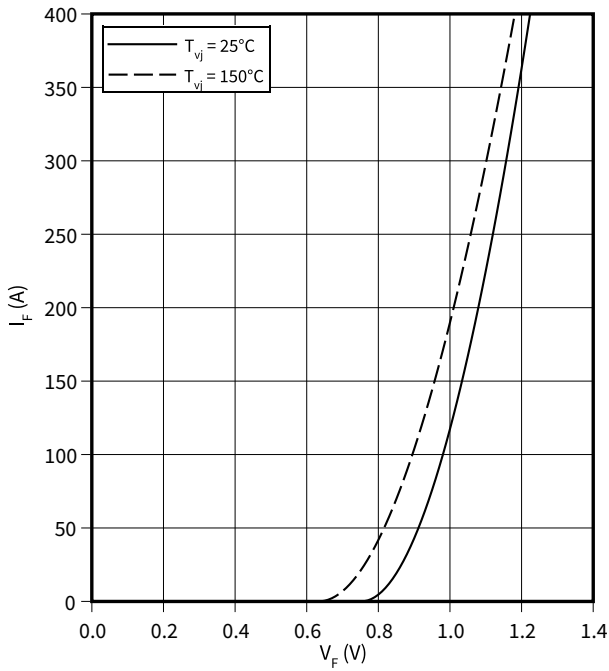

transient thermal impedance, Diode, Rectifier

$Z_{th} = f(t)$

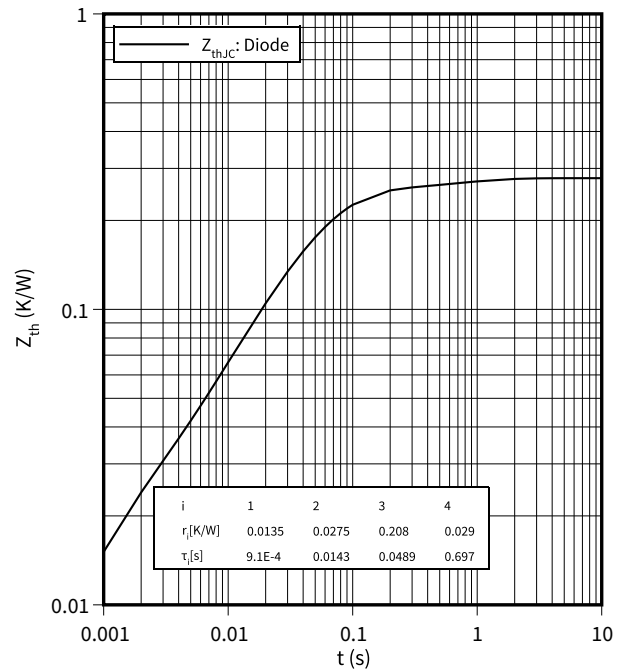

output characteristic (typical), IGBT, Brake-Chopper

$I_C = f(V_{CE})$

$V_{GE} = 15 \text{ V}$

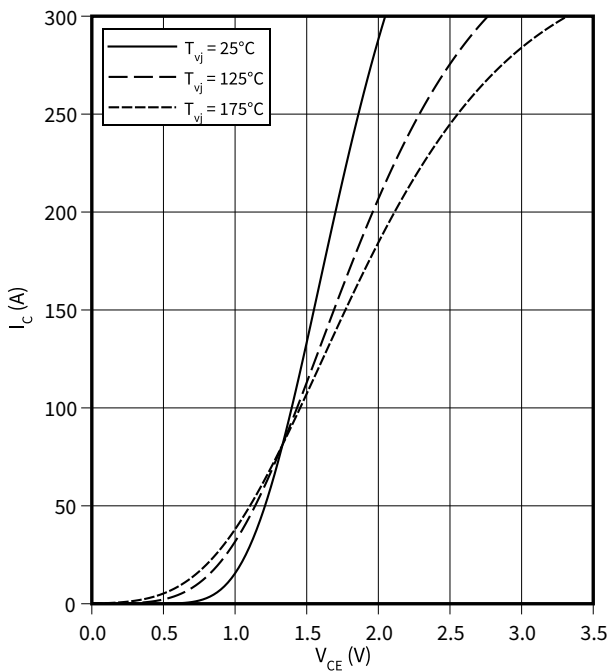

forward characteristic (typical), Diode, Brake-Chopper

$I_F = f(V_F)$

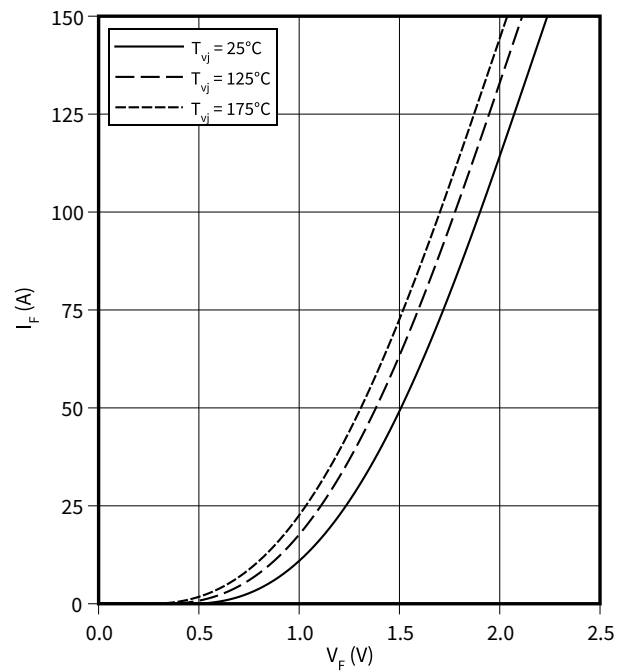

temperature characteristic (typical), NTC-Thermistor

$$R = f(T_{NTC})$$

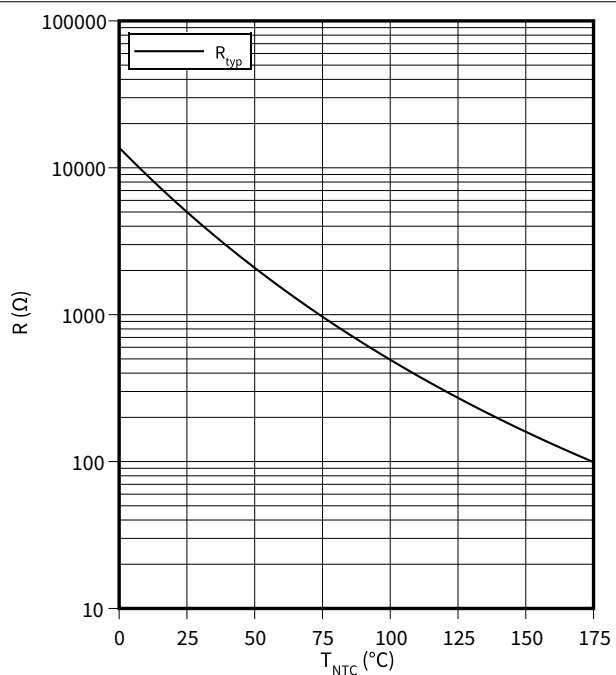

9 Circuit diagram

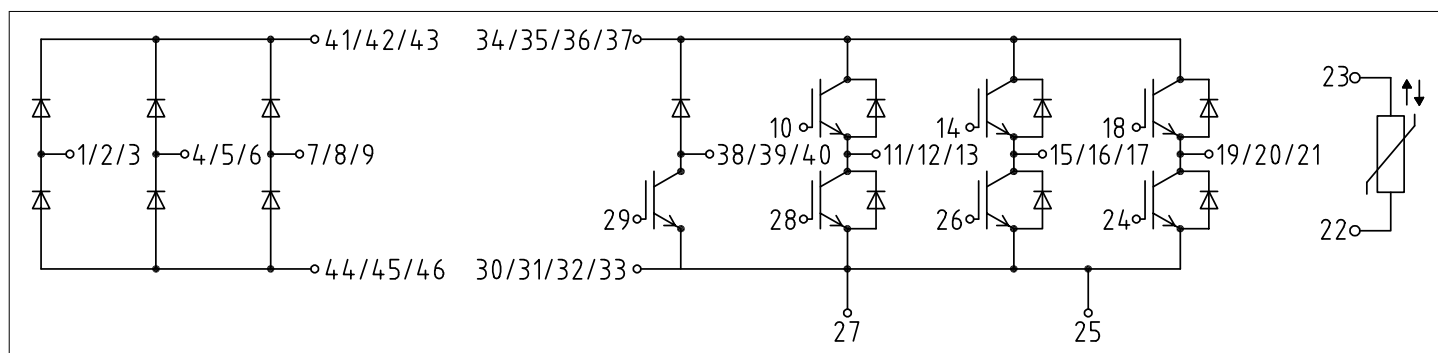

Figure 2

10 Package outlines

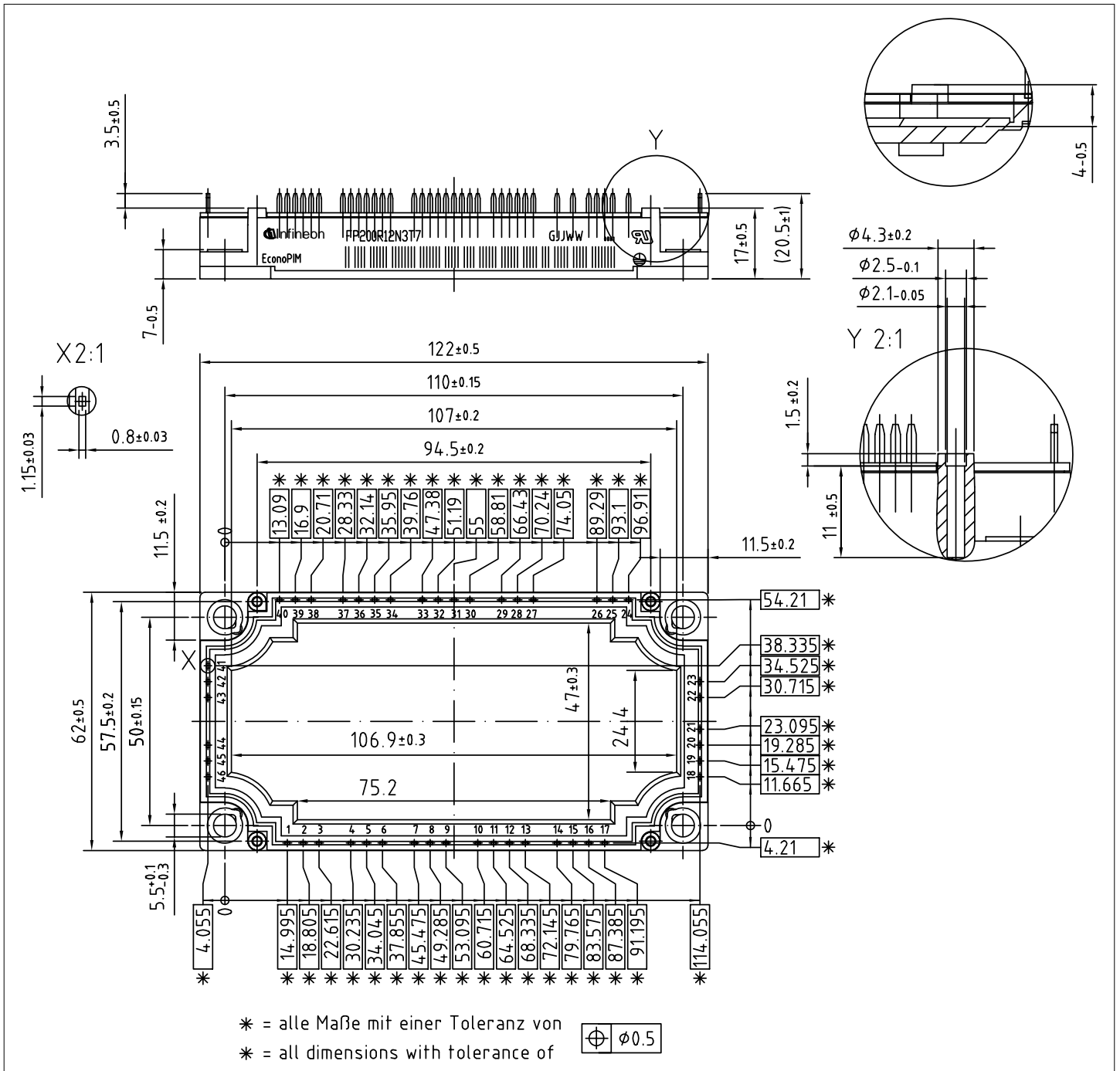

Figure 3

11 Module label code



Module label code			
Code format	Data Matrix	Barcode Code128	
Encoding	ASCII text	Code Set A	
Symbol size	16x16	23 digits	
Standard	IEC24720 and IEC16022	IEC8859-1	
Code content	Content	Digit	Example
	Module serial number	1 - 5	71549
	Module material number	6 - 11	142846
	Production order number	12 - 19	55054991
	Date code (production year)	20 - 21	15
	Date code (production week)	22 - 23	30
Example	 		
	71549142846550549911530		71549142846550549911530

Figure 4

Trademarks

All referenced product or service names and trademarks are the property of their respective owners.

Edition 2021-04-13

Published by

Infineon Technologies AG

81726 Munich, Germany

© 2021 Infineon Technologies AG

All Rights Reserved.

Do you have a question about any aspect of this document?

Email: erratum@infineon.com

Document reference

IFX-

IMPORTANT NOTICE

The information given in this document shall in no event be regarded as a guarantee of conditions or characteristics ("Beschaffheitsgarantie").

With respect to any examples, hints or any typical values stated herein and/or any information regarding the application of the product, Infineon Technologies hereby disclaims any and all warranties and liabilities of any kind, including without limitation warranties of non-infringement of intellectual property rights of any third party.

In addition, any information given in this document is subject to customer's compliance with its obligations stated in this document and any applicable legal requirements, norms and standards concerning customer's products and any use of the product of Infineon Technologies in customer's applications.

The data contained in this document is exclusively intended for technically trained staff. It is the responsibility of customer's technical departments to evaluate the suitability of the product for the intended application and the completeness of the product information given in this document with respect to such application.

Please note that this product is not qualified according to the AEC Q100 or AEC Q101 documents of the Automotive Electronics Council.

WARNINGS

Due to technical requirements products may contain dangerous substances. For information on the types in question please contact your nearest Infineon Technologies office.

Except as otherwise explicitly approved by Infineon Technologies in a written document signed by authorized representatives of Infineon Technologies, Infineon Technologies' products may not be used in any applications where a failure of the product or any consequences of the use thereof can reasonably be expected to result in personal injury.