

L9963 single Node in a Distributed BMS System

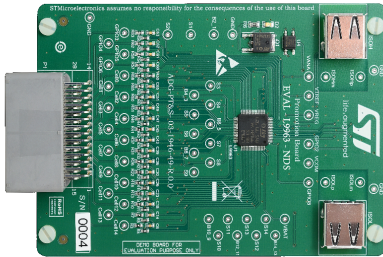

Features

- Single node L9963 board for distributed multi-cell BMS
- To be used with EVAL-L9963-MCU or EVAL-L9963 as second stage or stacked with additional EVAL-L9963-NDS
- Measures from 4 to 14 cells in series, with 0 us desynchronization delay between samples. Supports also busbar connection without altering cell results
- Coulomb counter supporting pack overcurrent detection in both ignition on and off states
- Fully synchronized current and voltage samples
- 16-bit voltage measurement
- Communication between nodes through a 2.66 Mbps isolated serial communication with regenerative buffer, supporting dual access ring
- Transformer based isolation
- Up to 4 analog inputs for NTC sensing, plus PCB temperature sensing
- Hot-plug protection circuit

Description

The **EVAL-L9963-NDS** is a hardware tool for L9963 for Li-ION battery management application. The board is intended to be used as a single node in a distributed BMS. EVAL-L9963-NDS is needed when the total number of battery cells to be managed exceeds 14. The number of nodes to be stacked depends on total battery voltage, additional nodes can be added via additional EVAL-L9963-NDS. A maximum of 14 total nodes beyond the base node EVAL-L9963-MCU or an EVAL-L9963 can be stacked. It has to be used in conjunction with EVAL-L9963-MCU or an EVAL-L9963 as second stage or stacked with additional EVAL-L9963-NDS.

EVAL-L9963-NDS allows the user to manage up to 14 channels for cell voltage sensing, one channel for current sensing, and up to 4 analog input for temperature sensing (plus an additional on-board NTC to sense PCB temperature). The board provides additional protection for hot plug.

EVAL-L9963-NDS is not intended to be used as a standalone evaluation board but with EVAL-L9963-MCU or EVAL-L9963.

Product summary

Order code	EVAL-L9963-NDS
Reference	EVAL-L9963-NDS Evaluation board

1 Block Diagram

EVAL-L9963-NDS provides a single L9963 device with the external connectors for battery and isolated communication.

Figure 1. EVAL-L9963-NDS block diagram

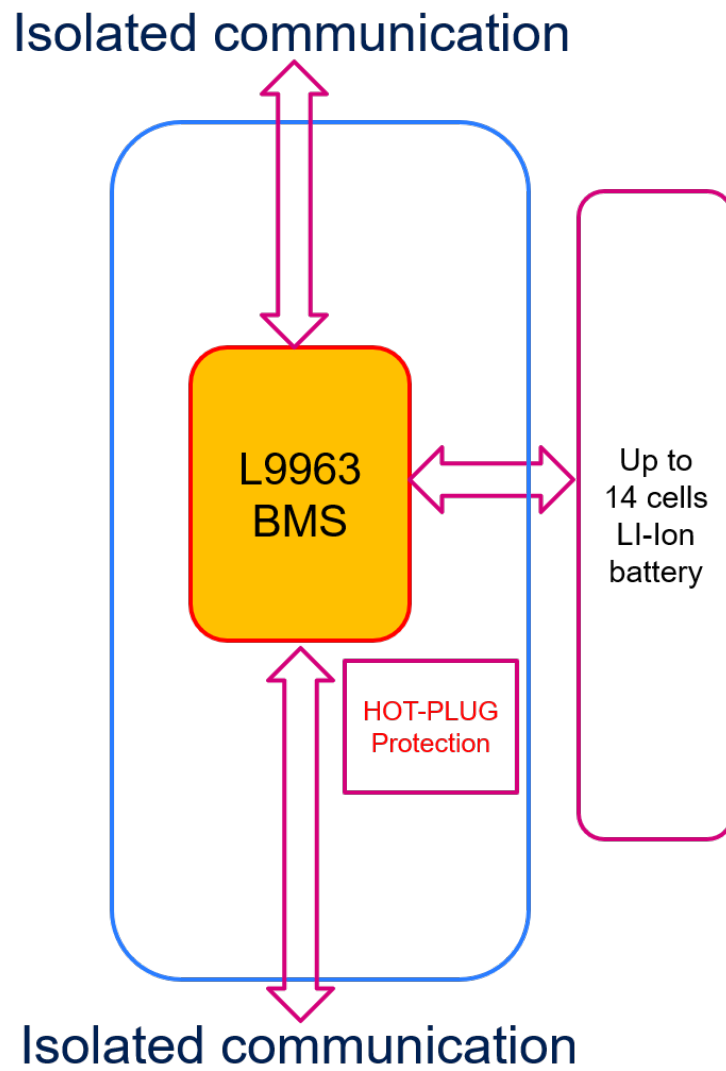

2 Featured components

The EVAL-L9963-NDS can be considered as an additional node in a distributed BMS system, the first stage should be implemented with an EVAL-L9963-MCU or an EVAL-L9963-NDS. In the following table there is a short description of all ST featured components.

Table 1. Featured components

Name	Description
L9963	Automotive chip for battery management applications

3 Minimum system requirements

- EVAL-L9963-MCU or EVAL-L9963 as first stage of a distributed BMS system
- Power supply:
- at least 3 output 0 – 30 V (if possible 60V):
 - 1 output to power L9963 (0:60 V)
 - 1 output to simulate Cells common mode voltage (0:60V)
 - 1 output to simulate Cell voltage (0:5V)

4 Connectors

Table 2. EVAL-L9963-NDS connectors

Name	Description	Configuration
ISOL	Isolated serial communication port: 1. Fault Line supply 2. ISOLm 3. ISOLp 4. FaultL	USB Type A connector
ISOH	Isolated serial communication port: 1. Fault Line supply 2. ISOHm 3. ISOHp 4. FaultH	USB Type A connector
P2	Battery connector: 1. Cell 14 2. Cell 12 3. Cell 10 4. Cell 8 5. Cell 6 6. Cell 4 7. Cell 2 8. Cell 0 9. Ground 10. Current sensor resistor negative pin 11. NTC 1- 12. NTC 2- 13. NTC3 - 14. NTC4 - 15. VBAT 16. Cell 13 17. Cell 11 18. Cell 9 19. Cell 7 20. Cell 5 21. Cell 3 22. Cell 1 23. Ground 24. Current sensor resistor positive pin 25. NTC 1+ 26. NTC 2+ 27. NTC3 + 28. NTC4 +	Multi pin connector

5 Hot plug protection

Figure 2. Hot plug protection circuit

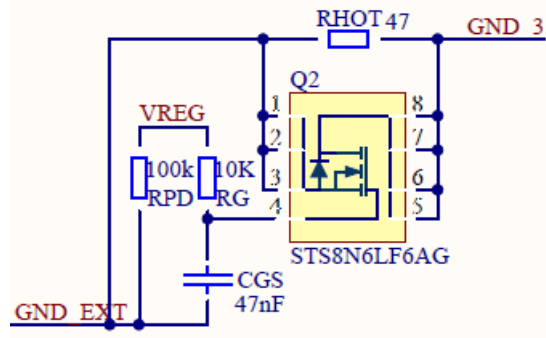

The structure in Figure 2. Hot plug protection circuit on the GND path will help with standing the hot plug by limiting the inrush current incoming from any L9963 pin connected to the centralized clamp.

Working principle is the following:

- When L9963 is OFF and no cell is connected, the VREG regulator is shut down and MHOT is safely kept off by the RPD pull down resistor.
- Upon the first hot plug event, inrush current incoming from the centralized clamp is forced to flow into RHOT resistor, which offers proper limiting.
- Any VDS voltage spike on MOSFET during hot plug could be coupled to the gate via the parasitic Miller capacitance. Unwanted turn-on is safely filtered by CGS, that helps keeping VGS below the threshold voltage. Hence the MOSFET will stay OFF during hot plug.
- If the hot plug voltage is enough to guarantee L9963 powerup the MOSFET will be turned on by VREG regulator with a proper delay, obtained through RG gate resistor.
- Finally, during L9963 normal operation the MOSFET will be ON, thus guaranteeing a very low impedance path (few mΩ) on the AGND line.
 - Such a small shift between L9963 GND and battery pack GND will not alter cell measurement at all, since cell ADCs are fully differential. Hence, both cell and sum of cells measurements will be accurate.
 - Moreover, since L9963 only drains few mA from the battery pack, error introduced on the VBAT stack measurement via internal voltage divider will be negligible.
 - Also the CSA used for Coulomb Counting features a fully differential architecture, thus being immune to such a small common mode shift.

6 Distributed BMS topology

EVAL-L9963-NDS is intended to be used in combination with either EVAL-L9963-MCU or EVAL-L9963 as an additional node of a distributed BMS system. EVAL-L9963-MCU or EVAL-L9963 are needed as first stage and up to 14 EVAL-L9963-NDS can be connected as additional nodes. In [Figure 3. Distributed BMS architecture](#) a possible layout for a distributed BMS using multiple EVAL-L9963-NDS together with either EVAL-L9963-MCU or EVAL-L9963. Distributed BMS architecture.

Figure 3. Distributed BMS architecture

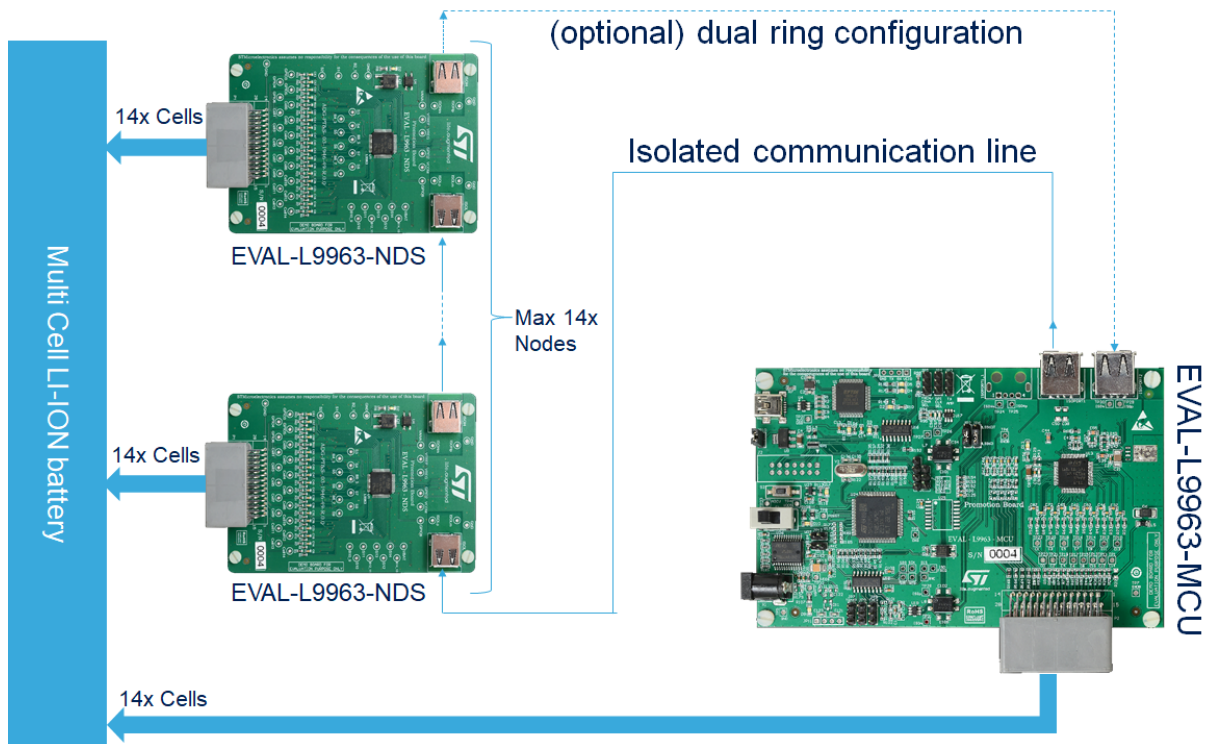

7 EVAL-L9963 Evaluation board schematic

Figure 4. Board schematic: page 1

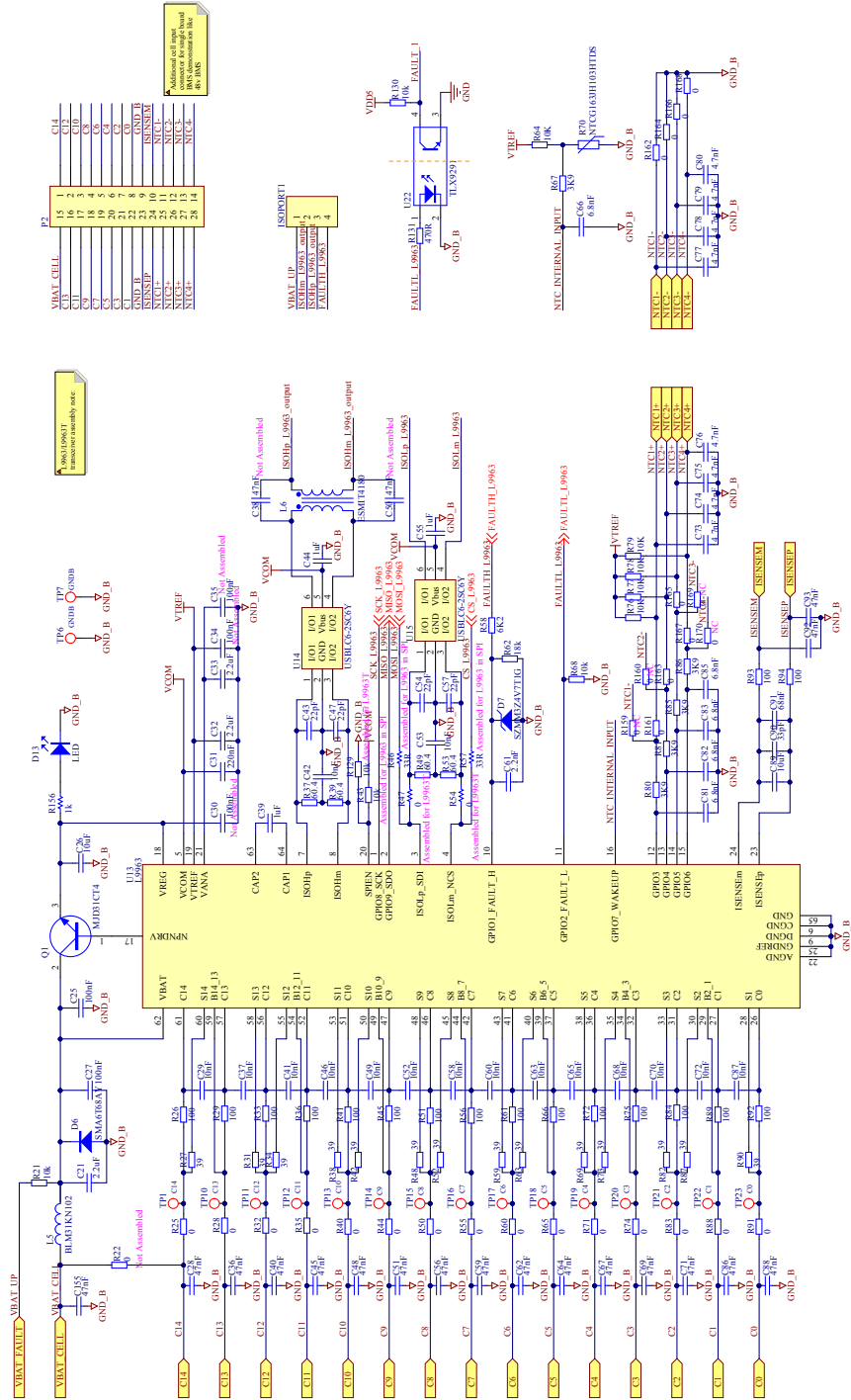

8 Board layout

Figure 5. Assembly TOP

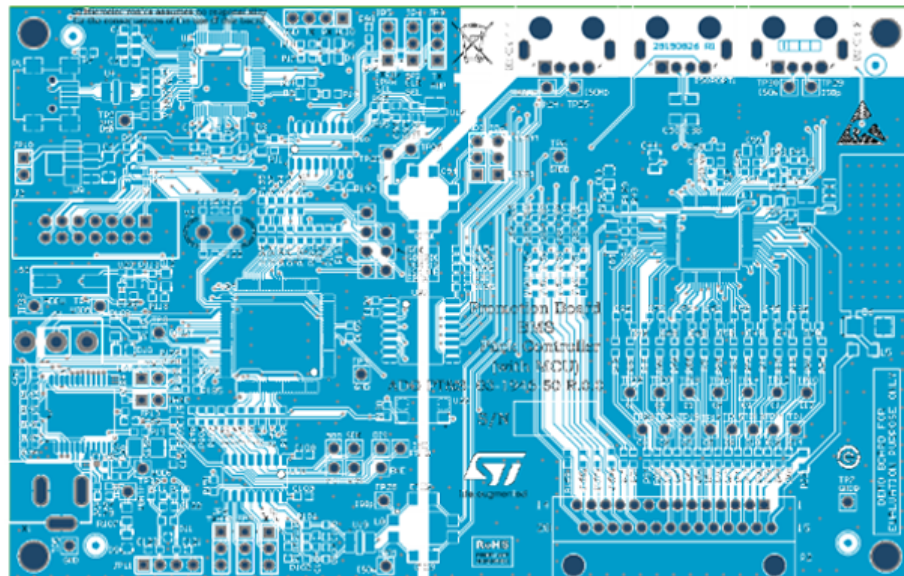
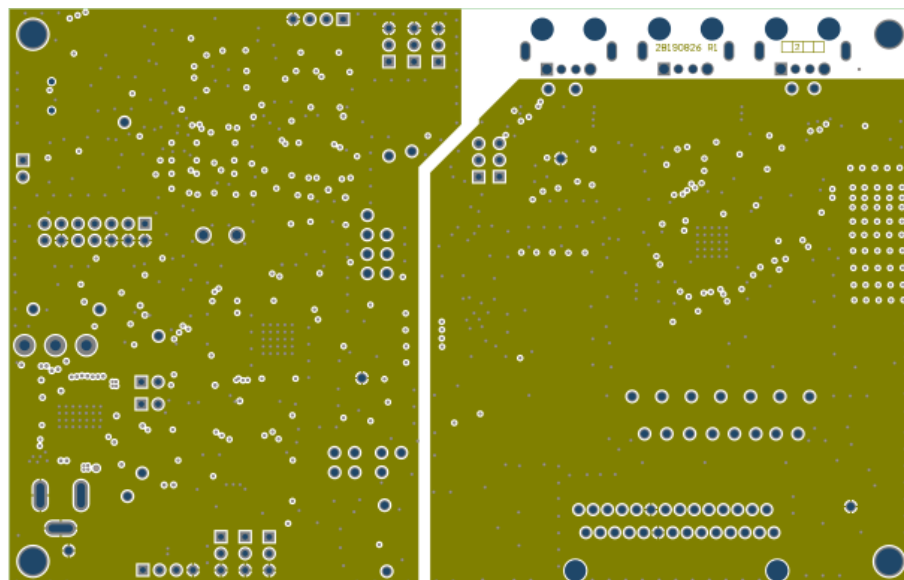

Figure 6. Inner 1



Revision history

Table 3. Document revision history

Date	Version	Changes
06-Apr-2020	1	Initial release.

IMPORTANT NOTICE – PLEASE READ CAREFULLY

STMicroelectronics NV and its subsidiaries (“ST”) reserve the right to make changes, corrections, enhancements, modifications, and improvements to ST products and/or to this document at any time without notice. Purchasers should obtain the latest relevant information on ST products before placing orders. ST products are sold pursuant to ST’s terms and conditions of sale in place at the time of order acknowledgement.

Purchasers are solely responsible for the choice, selection, and use of ST products and ST assumes no liability for application assistance or the design of Purchasers’ products.

No license, express or implied, to any intellectual property right is granted by ST herein.

Resale of ST products with provisions different from the information set forth herein shall void any warranty granted by ST for such product.

ST and the ST logo are trademarks of ST. For additional information about ST trademarks, please refer to www.st.com/trademarks. All other product or service names are the property of their respective owners.

Information in this document supersedes and replaces information previously supplied in any prior versions of this document.

© 2020 STMicroelectronics – All rights reserved