

# Part No. 9002137

## GNSS L1/L2/L5/L6 Chip Antenna

(1575.42 / 1227.6 / 1176.45 / 1278.75) MHz or (1560-1610) MHz

Supports: Tracking, Smart Home, Agriculture, Healthcare, Digital Signage, Wearables, Industrial Devices

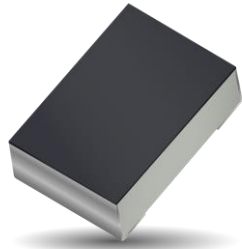

KYOCERA AVX series of chip antennas deliver on the key needs of device designers for higher functionality and performance in smaller/thinner designs. These innovative antennas provide compelling advantages for GNSS-enabled handheld devices.

**GNSS L1, L2, L5, L6 Chip Antenna**

1575.42 MHz, 1227.6 MHz, 1176.45 MHz  
 1278.75 MHz; or  
 1560 MHz-1610 MHz

**KEY BENEFITS**

**Greater Flexibility with Unique Form Factors**  
 KYOCERA AVX's technology helps you deliver more advanced ergonomic designs without adverse impact on product performance.

**Quicker Time-to-Market**  
 By optimizing antenna size, performance and emissions, customer and regulatory specifications are more easily met.

**Environmental Compliance**  
 Products are the latest RoHS version compliant.

**APPLICATIONS**

- Embedded design
- POS, Headsets, Tablets
- Gateway, Access Point
- Handheld
- Telematics
- Tracking
- Healthcare
- M2M, Industrial devices
- Smart Grid
- OBD-II

### Electrical Specifications

Typical performance on 90 x 40 mm PCB

Frequency (MHz)	1575.42	1227.6	1176.45	1278.75	1560-1610
GNSS Band	L1	L2	L5	L6	GNSS
Average Efficiency (%)	75	86	72	85	Refer to Appendix 1
VSWR Match	1.5:1 max	1.7:1 max	2.0:1 max	1.8:1 max	
Polarization	Linear				
Power Handling	0.5 Watt CW				
Feed Point Impedance	50 Ω unbalanced				

### Mechanical Specifications & Ordering Part Number

Ordering Part Number	9002137
Size (mm)	1.00 x 0.55 x 0.40
Mounting	Surface mounted to the PCB
Weight (grams)	< 0.001
Packaging	Tape & Reel 9002137 – 5,000 pieces per reel
Demo Board	9002137-06 (L1, L2, L5, L6) 9002137-05 (GNSS) Appendix 1

GNSS L1/L2/L5/L6 or GNSS KYOCERA AVX Embedded Chip Antenna Specifications  
 KYOCERA AVX produces a wide variety of standard and custom antennas to meet user needs

### Antenna Dimensions

Typical antenna dimensions (mm)

Part Number	L	W	T	B <sub>1</sub>	B <sub>2</sub>
9002137	1.00 ± 0.10	0.55 ± 0.07	0.40 ± 0.10	0.00 + 0.10	0.20 ± 0.10

**\*Mount Black Side up**

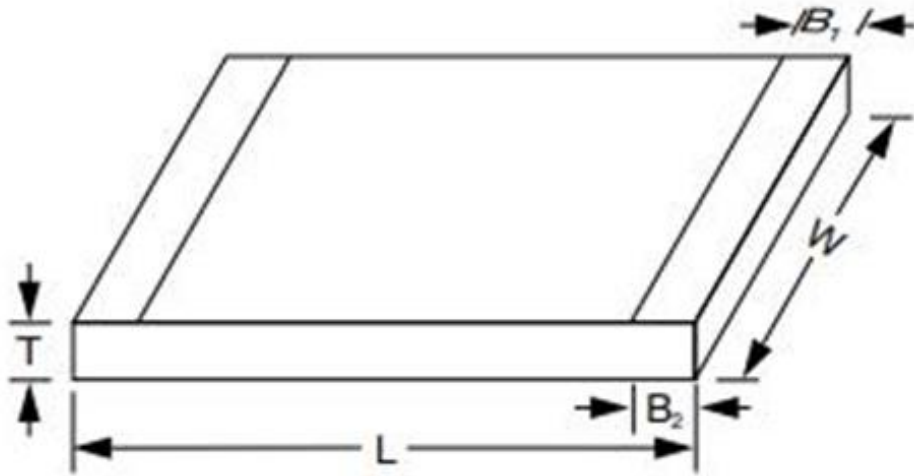

**GNSS L1/L2/L5/L6 or GNSS KYOCERA AVX Embedded Chip Antenna Specifications**  
 KYOCERA AVX produces a wide variety of standard and custom antennas to meet user needs

**Layout (9002137-06)**

Typical antenna dimensions (mm)

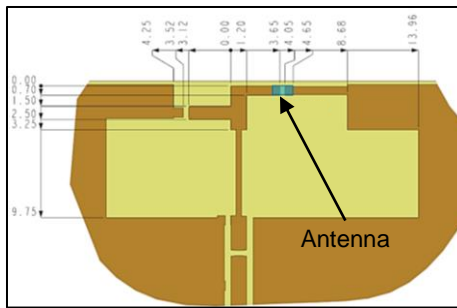
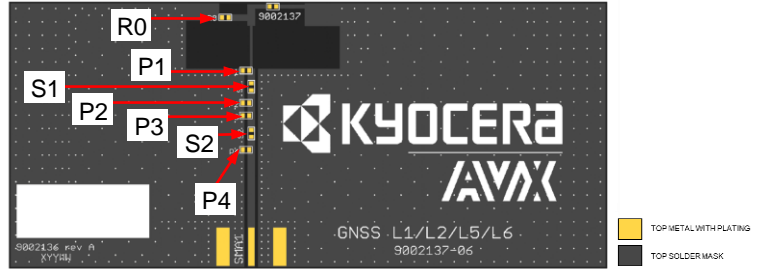
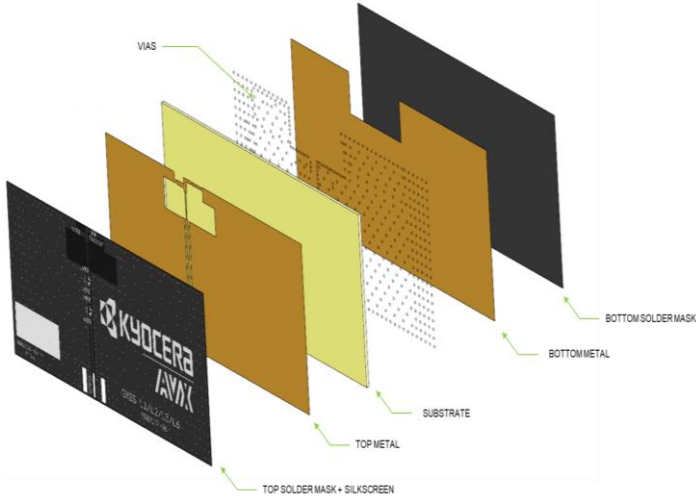

- Additional VIAS : Diam. 0.2mm to be placed around antenna, (no vias on transmission lines).
- Via holes must be covered by solder mask

**Matching Pi Network**

R0	P1	S1	P2	P3	S2	P4
0.5 pF	DNI	2 pF	8.2 nH	DNI	0 Ω	DNI

\*Actual matching values depend on customer design

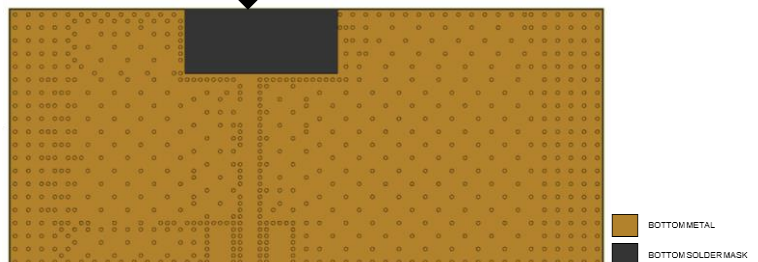
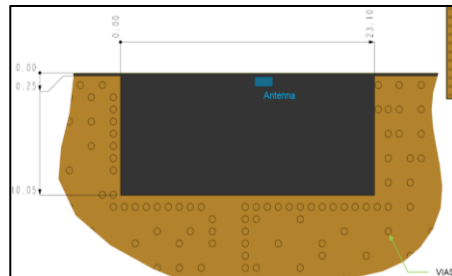
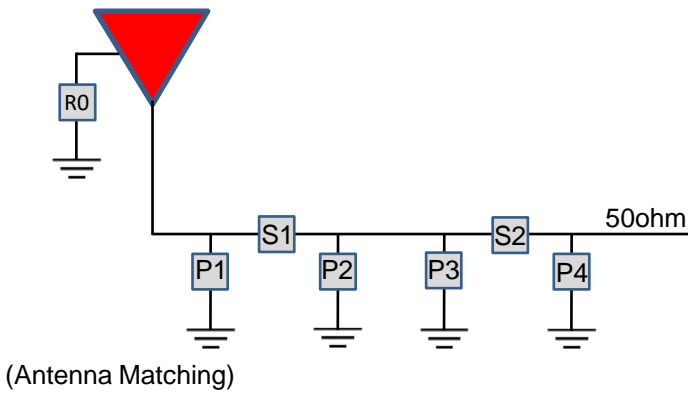
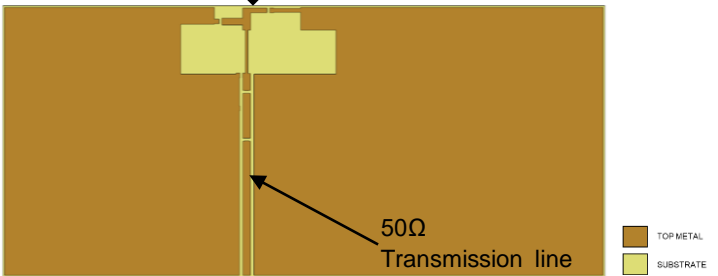

**GNSS L1/L2/L5/L6 or GNSS KYOCERA AVX Embedded Chip Antenna Specifications**  
 KYOCERA AVX produces a wide variety of standard and custom antennas to meet user needs

**VSWR, Efficiency Plots (9002137-06)**

Typical performance on 90 x 40 mm PCB

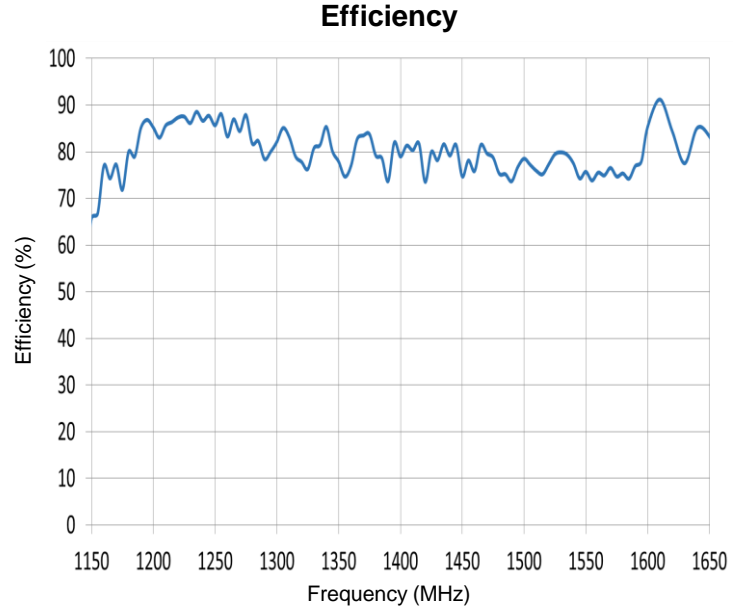
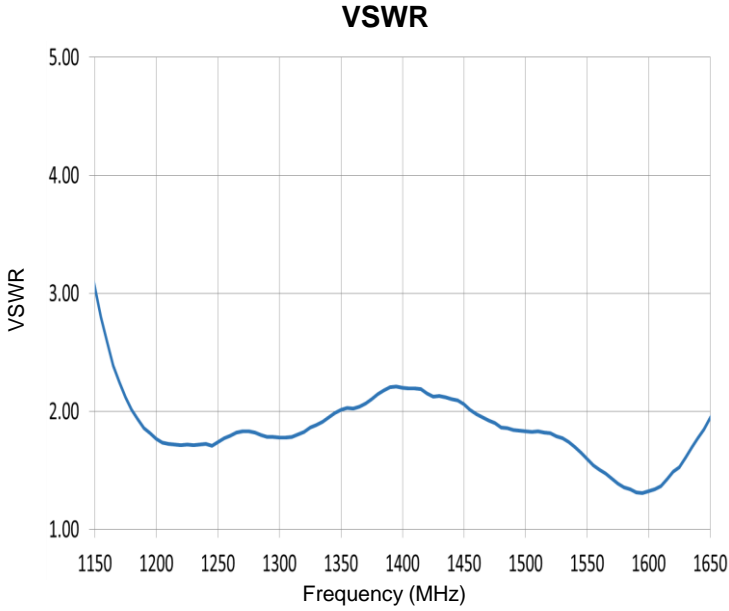

**Antenna Radiation Patterns (9002137-06)**

Typical performance on 90 x 40 mm PCB  
 Measured @ 1175 MHz, 1225 MHz, 1275 MHz, 1575 MHz

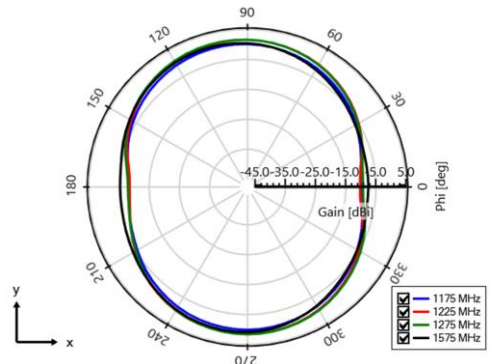
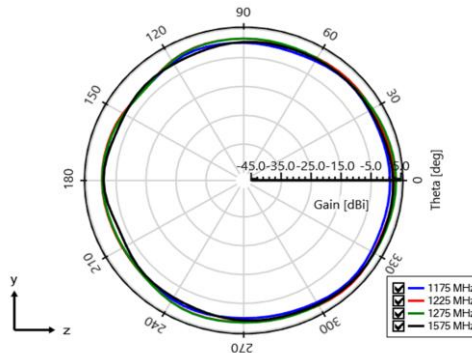
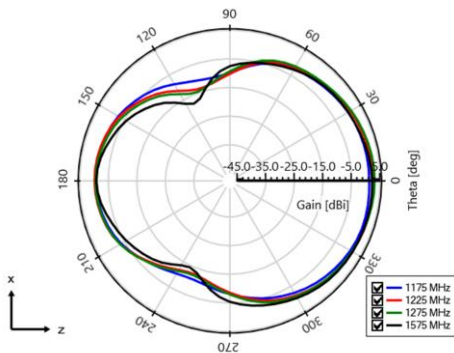
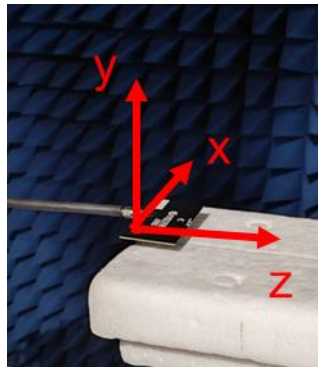

GNSS L1/L2/L5/L6 or GNSS KYOCERA AVX Embedded Chip Antenna Specifications  
 KYOCERA AVX produces a wide variety of standard and custom antennas to meet user needs

Antenna Demo Board

Typical layout dimensions (mm)

Part Number	Description	A	B
9002137-06	L1, L2, L5, L6	90.0	40.0

9002137-06

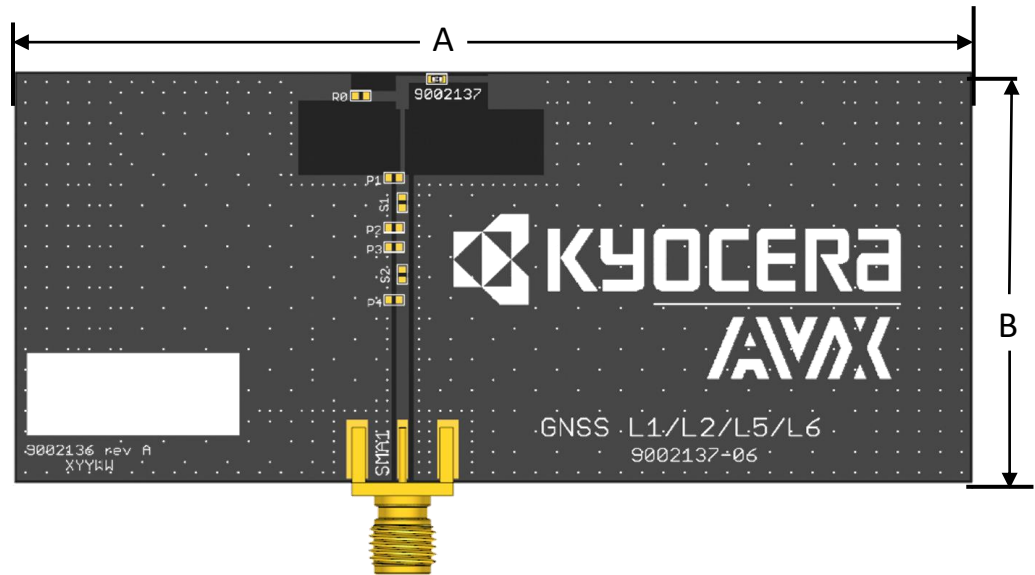

GNSS L1/L2/L5/L6 or GNSS KYOCERA AVX Embedded Chip Antenna Specifications  
 KYOCERA AVX produces a wide variety of standard and custom antennas to meet user needs

# Appendix 1

Appendix 1 gives instructions on how to achieve GNSS coverage (Beidou/GPS/Galileo/Glonass) using the 9002137-05 layout.

Frequency (MHz)	1560-1610
Peak Gain	2.0 dBi
Average Efficiency	65%
VSWR Match	< 2.0:1
Polarization	Linear
Power Handling	0.5 Watt CW
Feed Point Impedance	50 $\Omega$ unbalanced

\*Data shown above has Appendix 1 matching applied on 80 x 40 mm PCB.

**GNSS L1/L2/L5/L6 or GNSS KYOCERA AVX Embedded Chip Antenna Specifications**  
 KYOCERA AVX produces a wide variety of standard and custom antennas to meet user needs

**Layout (9002137-05)**

Typical antenna dimensions (mm)

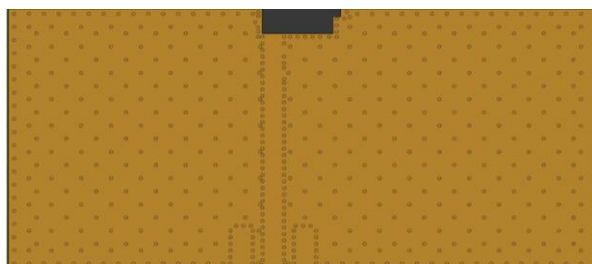
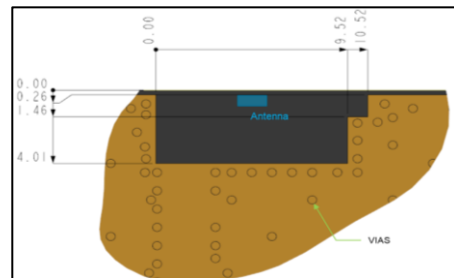
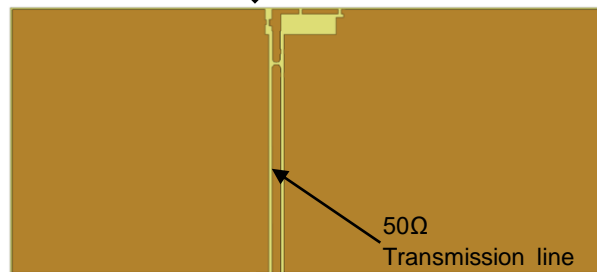
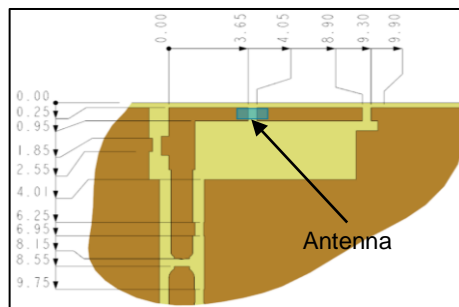
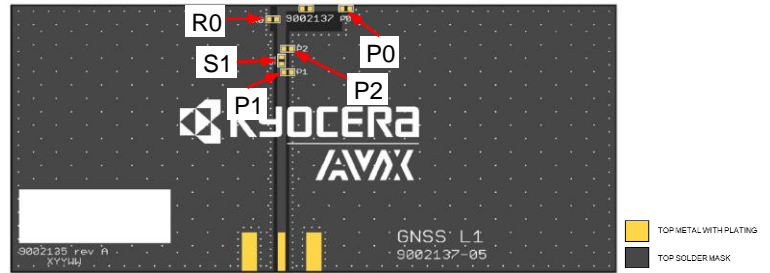
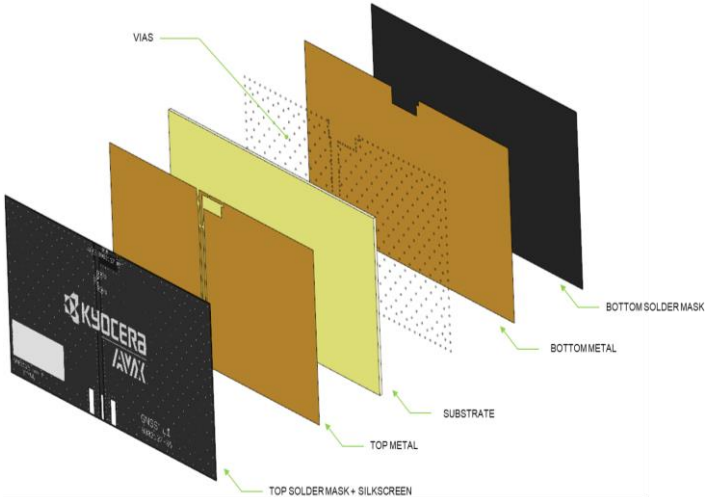

- Additional VIAS : Diam. 0.2mm to be placed around antenna, (no vias on transmission lines).
- Via holes must be covered by solder mask

**Matching Pi Network**

P0	R0	P1	S1	P2
82 pF	1 nH	DNI	0 Ω	DNI

\*Actual matching values depend on customer design

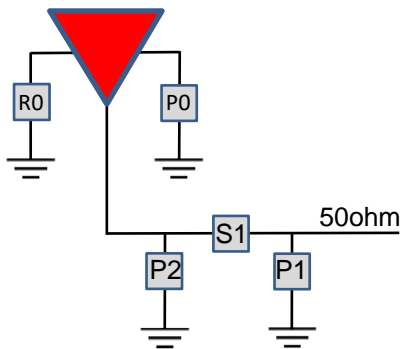

(Antenna Matching)

**GNSS L1/L2/L5/L6 or GNSS KYOCERA AVX Embedded Chip Antenna Specifications**  
 KYOCERA AVX produces a wide variety of standard and custom antennas to meet user needs

**VSWR, Efficiency Plots (9002137-05)**

Typical performance on 80 x 40 mm PCB

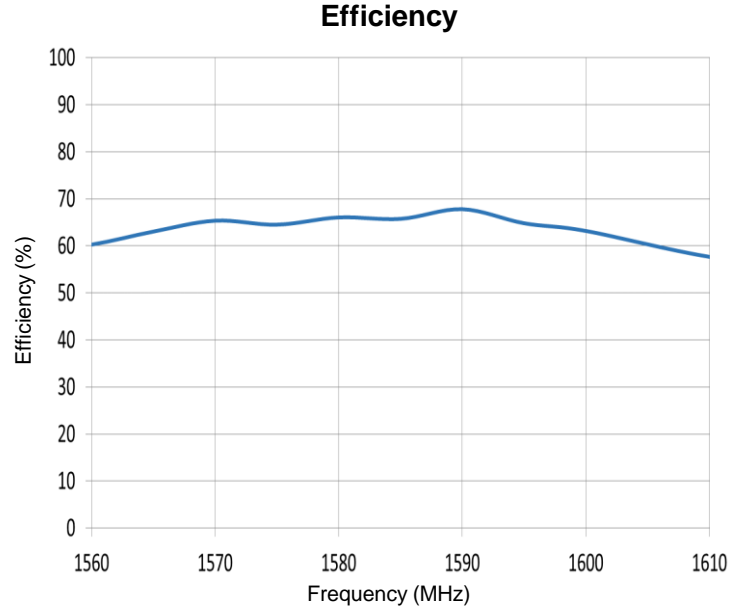
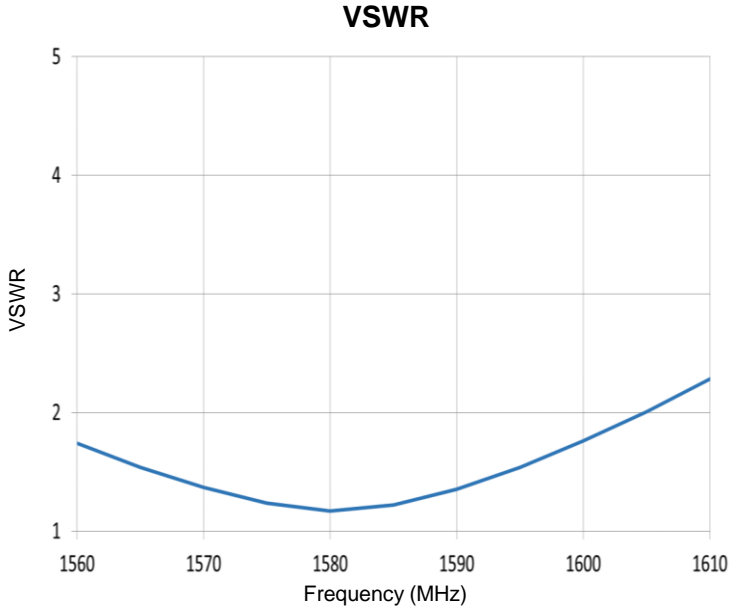

**Antenna Radiation Patterns (9002137-05)**

Typical performance on 80 x 40 mm PCB  
 Measured @ 1575 MHz

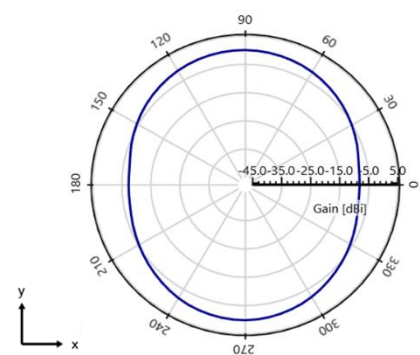
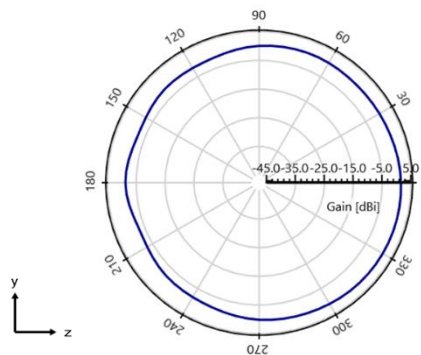
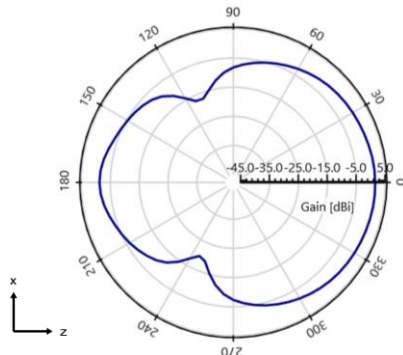



GNSS L1/L2/L5/L6 or GNSS KYOCERA AVX Embedded Chip Antenna Specifications  
 KYOCERA AVX produces a wide variety of standard and custom antennas to meet user needs

**Antenna Demo Board (9002137-05)**

Typical layout dimensions (mm)

Part Number	Description	A	B
9002137-05	GNSS (Beidou/GPS/Galileo/Glonass)	80.0	40.0

9002137-05

