

AN90042

Nexperia IGBT family product introduction

Rev. 1 — 3 July 2023

Application note

Document information

Information	Content
Keywords	IGBT, nomenclature, performance, technology
Abstract	This application note provides an overview of Nexperia's discrete IGBT products. It contains a brief technology overview, and discusses the static and dynamic performances of the NGW30T60M3DF compared to competitor products. Finally, a selection guide is included.

1. Introduction

Since their introduction, Insulated Gate Bipolar Transistors (IGBT) have become one of the most commonly used electronic components. They are central to the inverters found in drivers, battery chargers, as well as solar and wind plants. With the increasing global focus on renewable energy and demand for efficiency, having a reliable and robust package is critical for industries to stay competitive. Nexperia's line of IGBT products are optimized for fast switching and low power losses in a small footprint. This application note is an introduction to Nexperia's current IGBT product line, providing a brief technology overview, and a selection guide.

2. Technology overview

Nexperia's proprietary IGBT products feature a robust and cost-effective Carrier-Stored, Trench Gate advanced Field Stop (FS) construction (see [Fig. 1](#)). Nexperia's IGBTs utilize either a punch-through or a shorted-anode structure to maximize power density in a small package. Package types currently available include the TO247-3L and the TO247-3L-PLUS, with additional packages in development.

Functionally, IGBTs are essentially almost-ideal switches. A positive voltage across the gate-emitter allows current to flow through the collector; a negative voltage disrupts this flow. Because of the capacitive nature of the gate-emitter junction, only a very tiny gate current is required to charge the gate. The presence of a gate charge, however small, must be considered when incorporating IGBTs into product designs.

The gate charge also translates into energy loss. There is always a trade-off between switching losses, conduction losses, and the ability to withstand a short circuit. For example, a reduced switching loss means a higher conduction loss and reduced short circuit capacity.

While some modern power electronic devices have efficiency levels exceeding 99%, the heat generated by the energy loss can be tremendous. A throughput of over 10 MW is not unusual for commercial applications; even at an efficiency level of 99%, that means 100 kW is lost, mostly as heat. Currently heat dissipation represents one of the key limiting factors for IGBT use.

Nevertheless, IGBTs have numerous applications that require a broad range of currents and voltages. They are often used in home appliances, but also have industrial applications, such as for welding, solar inverters, uninterruptible power supplies, and chargers for electric vehicles. Nexperia's IGBT line have been developed with industrial applications such as motor control, photo-voltaic, UPS and EV chargers in mind, and have been optimized to provide a highly competitive option.

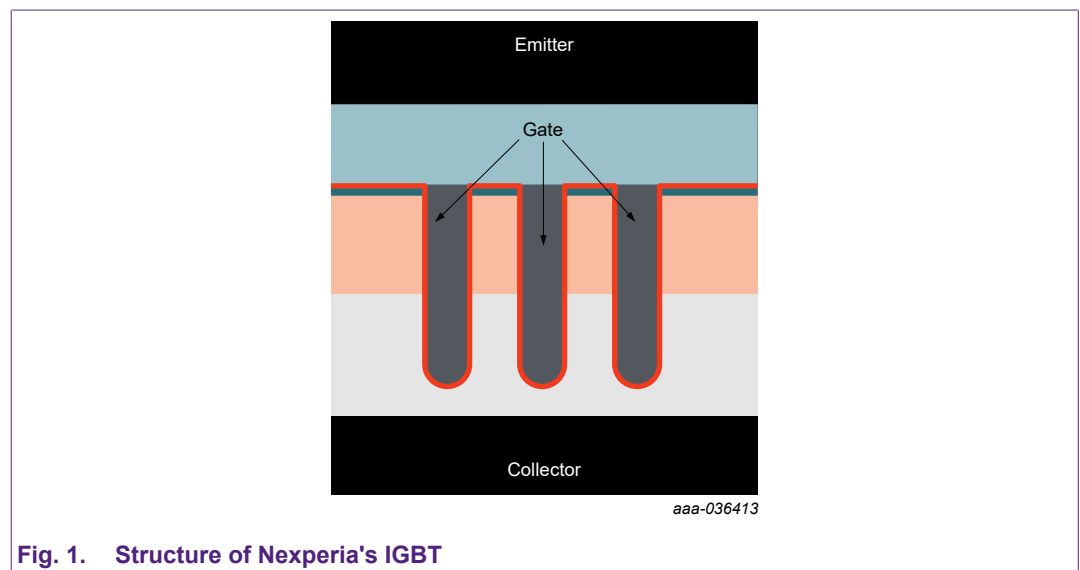

Fig. 1. Structure of Nexperia's IGBT

3. Description or product family

Nexperia's IGBT line offers a broad range of current and voltage ratings. Designers can choose between IGBTs with medium speed (M3) and high speed (H3) switching capabilities. Products in the M3 line are characterized by low conduction losses and switching losses. These are intended for applications which require a switching frequency of less than 20 kHz, such as motor drivers. Products in the H3 line are characterized by low switching losses and conduction losses, and are intended for applications which require switching frequency of up to 50 kHz, such as solar inverters, and welding. In both categories, the IGBT and integrated emitter-collector diode are optimized for peak performance.

To make selection simpler Nexperia's IGBT nomenclature follows the fairly standard convention where the first number represents the current rating and the second number represents 1/10 of the voltage rating. See [Fig. 2](#) for additional information.

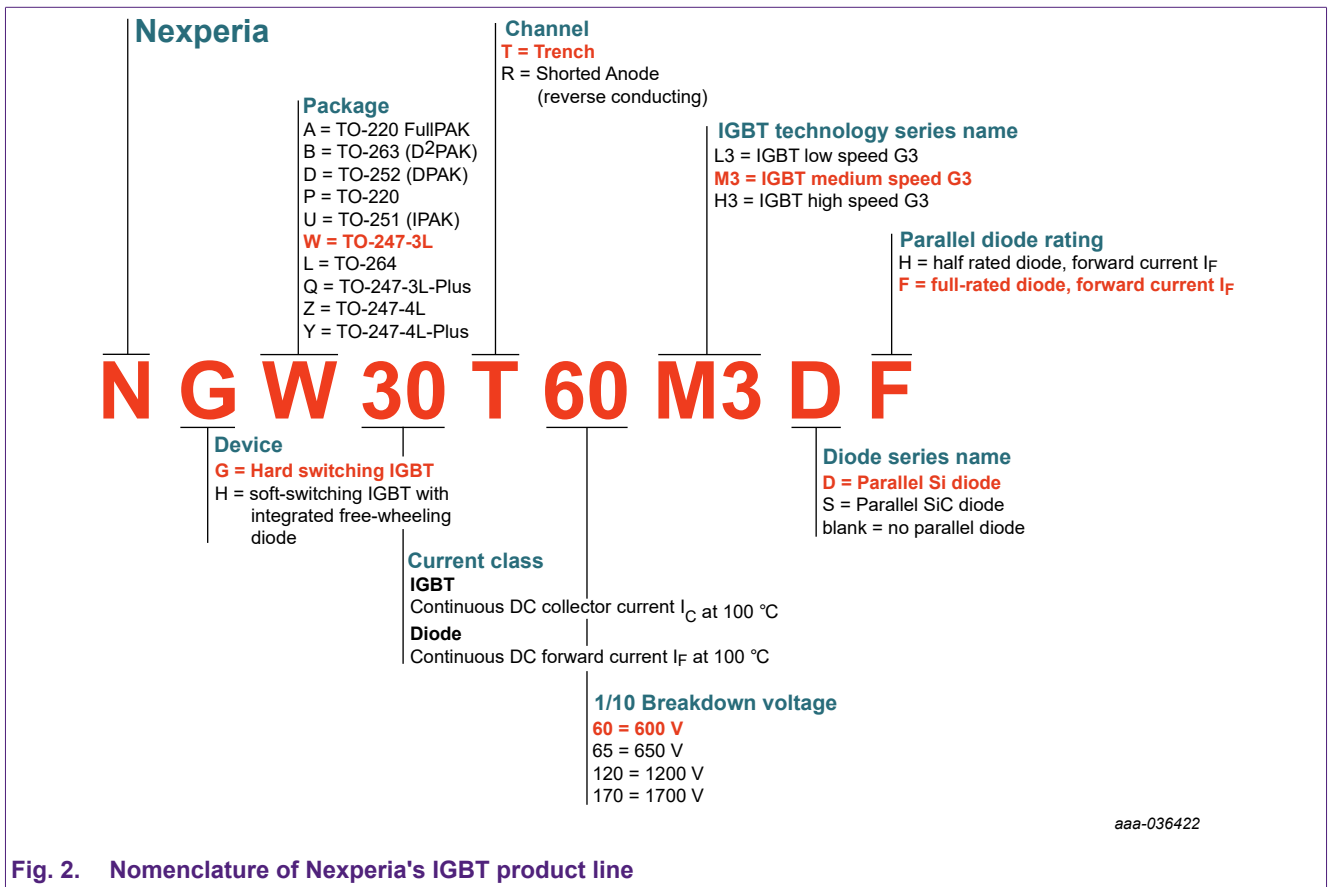

Fig. 2. Nomenclature of Nexperia's IGBT product line

Nexperia's IGBT family is divided according to [Fig. 3](#)

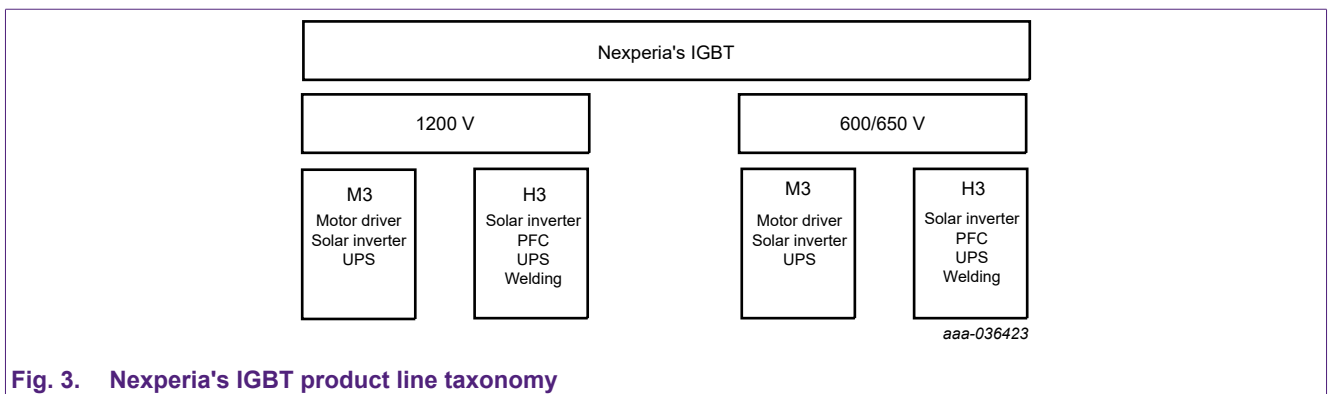
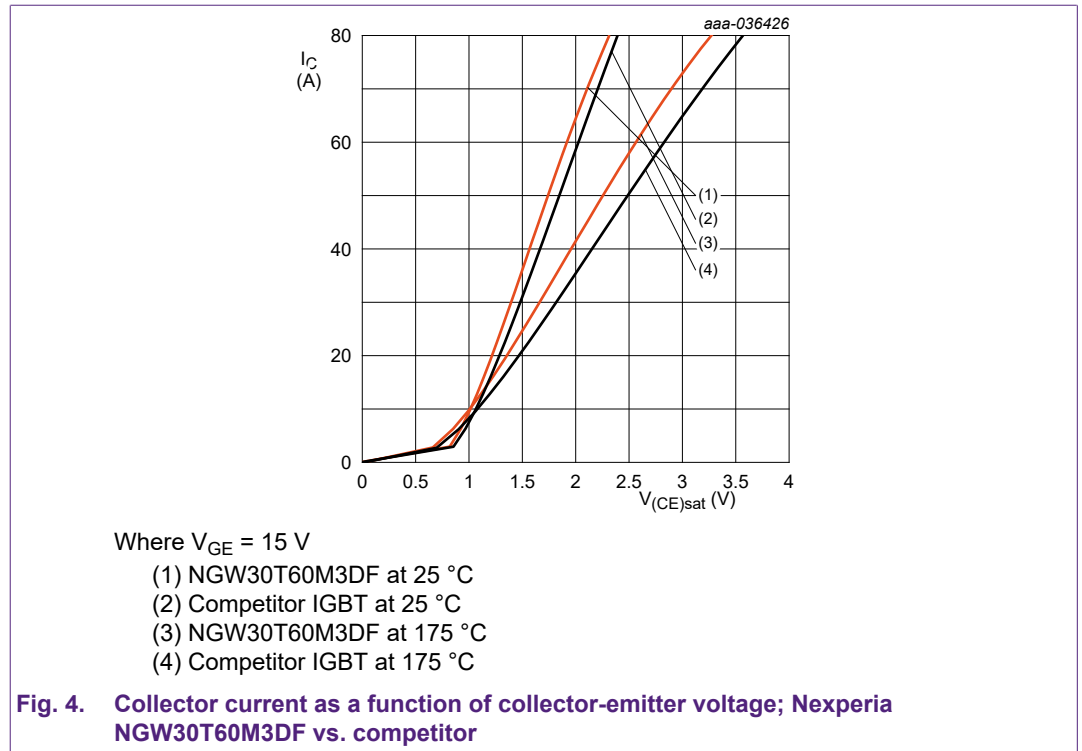

Fig. 3. Nexperia's IGBT product line taxonomy

4. IGBT static performance

Nexperia’s M3 IGBT have a very low collector-emitter saturation voltage over a wide range of collector currents and junction temperatures (see Fig. 4). This results in the following benefits at a systems level:

- Improving conduction losses in the system
- Higher system efficiency
- Small heatsink size



Compared to the competitor's product, Nexperia's NGW30T60M3DF have a reduced $V_{CE(sat)}$ across a wide range of collector currents. At the rated current (30A), this reduction is by 100 mV at 25 °C and 150 mV at 175 °C.

5. IGBT dynamic performance

Nexperia’s M3 IGBTs perform very well under switching conditions. This results in low switching losses at a systems level. Fig. 5 and Fig. 6 show the relationship between E_{off} losses and I_C and r_G , respectively. In both cases the E_{off} losses are significantly less than that of the competitor product.

Nexperia’s M3 IGBT reduced E_{off} as a function of the switching current (rated for 30A in this example) was approximately 200 μJ at 25 °C and 352 μJ at 175 °C. As the typical operating current range is between half and full nominal current, Nexperia’s M3 IGBT maintains the lower E_{off} losses over a wide range of r_G and emitter current.

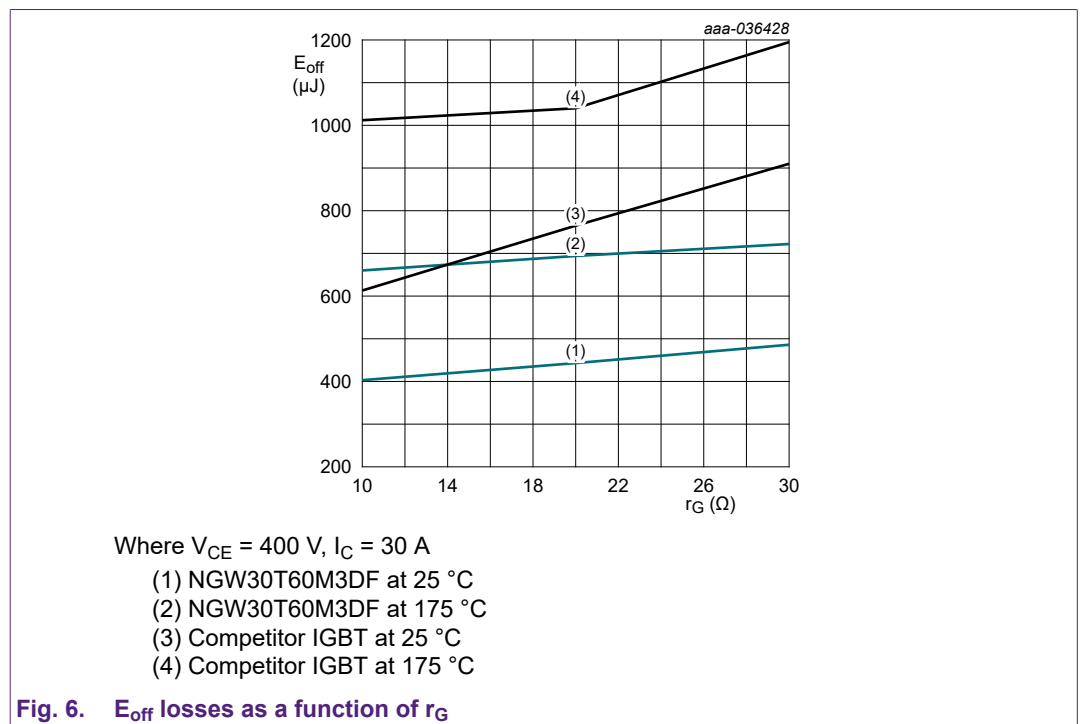
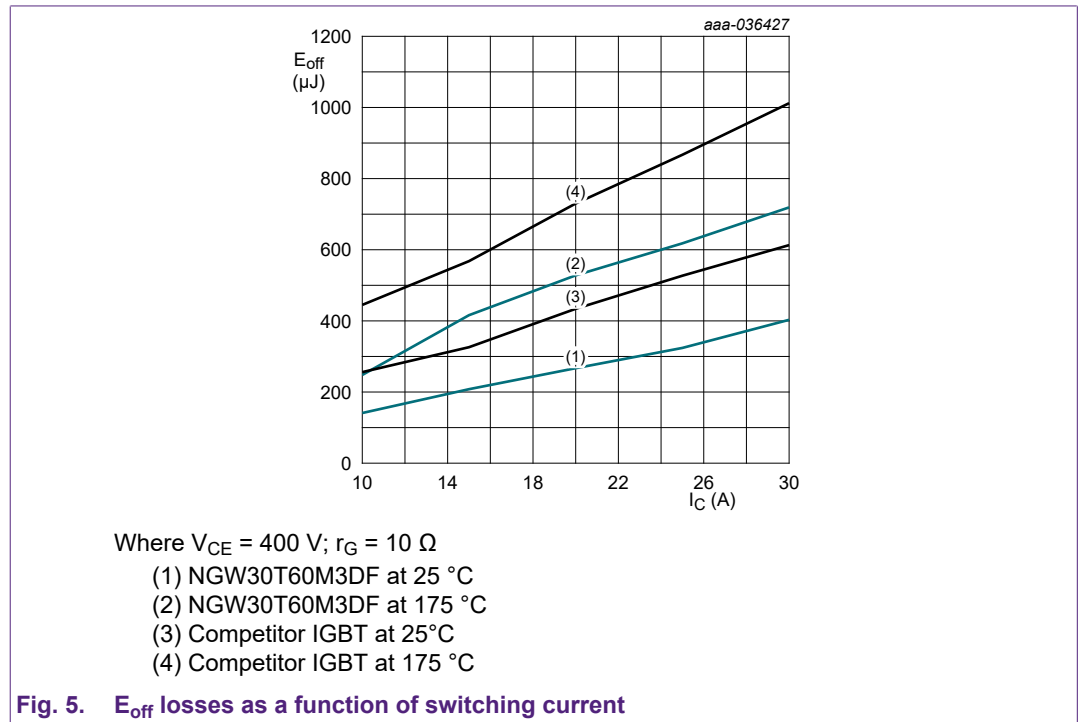

6. Power loss simulation in motor drive applications

Modern motor drives must control motor speed, position, and torque with high precision. Nexperia has optimized the trade-off between switching losses and conduction losses to make the M3 IGBT suitable for motor drive applications. See Fig. 7. Simulations were done to assess the switching loss and conduction loss in the NGW30T60M3DF under loaded conditions, and to compare the performance with competitor products.

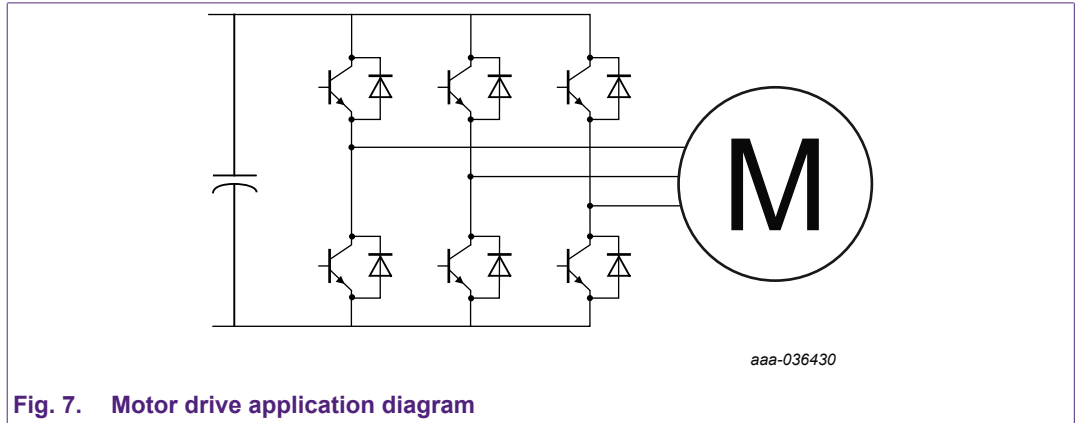

Fig. 7. Motor drive application diagram

The simulation conditions are shown in Table 1. The NGW30T60M3DF was compared to the competitor IGBT and the top-of-the-line IGBT currently available in the market (premium).

Table 1. Simulation details

Test conditions	
V_{DC}	400 V
I_{rrm}	30 A
f_{sw} (switching frequency)	10 kHz
modulation index	0.8
cos (power factor)	0.8

The results are summarized in Fig. 8.

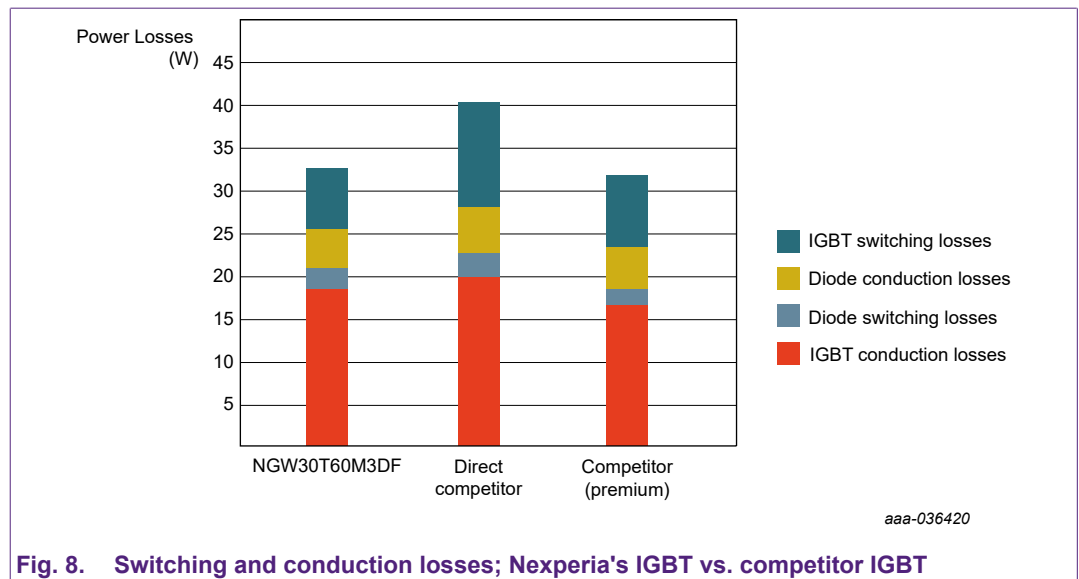

Fig. 8. Switching and conduction losses; Nexperia's IGBT vs. competitor IGBT

In conclusion:

- Nexperia’s M3 IGBT are optimized for good trade-off according to target switching frequencies.
- Nexperia’s M3 IGBT have an approximately 15% improvement in energy loss over the direct competitor and a slight improvement against the premium competitor.
- Compared with the competitor products, Nexperia’s M3 IGBT shows lowest switching losses.
- Nexperia’s IGBT low power losses meet energy efficiency requirements and increase design margin and reliability.

7. Selection guide

[Table 2](#) contains the main characteristics of M3 and H3 IGBT products and general application fields.

Table 2. Selection guide for IGBT products

Product family	M3	H3
Feature	<ul style="list-style-type: none"> • Low conduction losses and minimized switching losses • Stable and tight parameter for easy parallel operation • Maximum junction temperature 175 °C • Soft fast reverse recovery diode • 5-8 μs short-circuit capability at high temperature • RoHS compliant and Pb-free lead plating • Enabling outstanding system efficiency and reliability 	<ul style="list-style-type: none"> • Low conduction losses and minimized saturation voltage $V_{CE(sat)}$ • Stable and tight parameters for easy parallel operation • Maximum junction temperature 175 °C • Soft fast reverse recovery diode • Optimized for high speed hard and soft switching • RoHS compliant and Pb-free lead plating • Enabling outstanding system efficiency and reliability
Applications	<ul style="list-style-type: none"> • Industrial and home appliance motor driver • Solar string inverters • Uninterruptible power Inverter Suppliers 	<ul style="list-style-type: none"> • Home appliance PFC • Solar string inverters • Uninterruptible power Inverter Suppliers • Induction Heating • Welding

Typical switching frequency ranges of different IGBT products are shown in [Fig. 9](#)

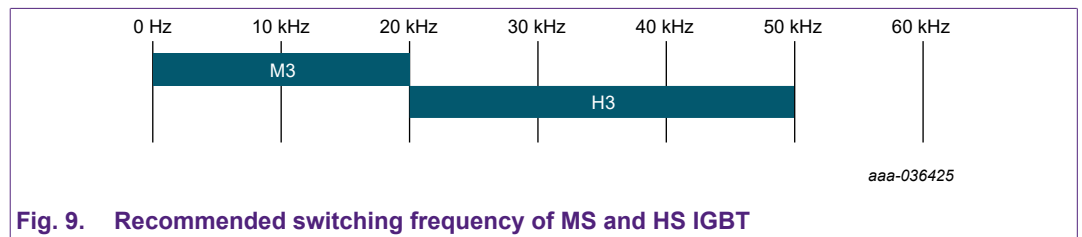

8. Abbreviations

Acronym	Description
H3	High Speed 3
IGBT	Insulated Gate Bipolar Transistor
M3	Medium Speed 3
RoHS	Restriction of Hazardous Substances
UPS	Uninterruptible Power Supply

9. Revision history

Revision number	Date	Description
AN90042 v. 1.10	20230629	

10. Legal information

Definitions

Draft — The document is a draft version only. The content is still under internal review and subject to formal approval, which may result in modifications or additions. Nexperia does not give any representations or warranties as to the accuracy or completeness of information included herein and shall have no liability for the consequences of use of such information.

Disclaimers

Limited warranty and liability — Information in this document is believed to be accurate and reliable. However, Nexperia does not give any representations or warranties, expressed or implied, as to the accuracy or completeness of such information and shall have no liability for the consequences of use of such information. Nexperia takes no responsibility for the content in this document if provided by an information source outside of Nexperia.

In no event shall Nexperia be liable for any indirect, incidental, punitive, special or consequential damages (including - without limitation - lost profits, lost savings, business interruption, costs related to the removal or replacement of any products or rework charges) whether or not such damages are based on tort (including negligence), warranty, breach of contract or any other legal theory.

Notwithstanding any damages that customer might incur for any reason whatsoever, Nexperia's aggregate and cumulative liability towards customer for the products described herein shall be limited in accordance with the Terms and conditions of commercial sale of Nexperia.

Right to make changes — Nexperia reserves the right to make changes to information published in this document, including without limitation specifications and product descriptions, at any time and without notice. This document supersedes and replaces all information supplied prior to the publication hereof.

Suitability for use — Nexperia products are not designed, authorized or warranted to be suitable for use in life support, life-critical or safety-critical systems or equipment, nor in applications where failure or malfunction of an Nexperia product can reasonably be expected to result in personal injury, death or severe property or environmental damage. Nexperia and its suppliers accept no liability for inclusion and/or use of Nexperia products in such equipment or applications and therefore such inclusion and/or use is at the customer's own risk.

Applications — Applications that are described herein for any of these products are for illustrative purposes only. Nexperia makes no representation or warranty that such applications will be suitable for the specified use without further testing or modification.

Customers are responsible for the design and operation of their applications and products using Nexperia products, and Nexperia accepts no liability for any assistance with applications or customer product design. It is customer's sole responsibility to determine whether the Nexperia product is suitable and fit for the customer's applications and products planned, as well as for the planned application and use of customer's third party customer(s). Customers should provide appropriate design and operating safeguards to minimize the risks associated with their applications and products.

Nexperia does not accept any liability related to any default, damage, costs or problem which is based on any weakness or default in the customer's applications or products, or the application or use by customer's third party customer(s). Customer is responsible for doing all necessary testing for the customer's applications and products using Nexperia products in order to avoid a default of the applications and the products or of the application or use by customer's third party customer(s). Nexperia does not accept any liability in this respect.

Export control — This document as well as the item(s) described herein may be subject to export control regulations. Export might require a prior authorization from competent authorities.

Translations — A non-English (translated) version of a document is for reference only. The English version shall prevail in case of any discrepancy between the translated and English versions.

Trademarks

Notice: All referenced brands, product names, service names and trademarks are the property of their respective owners.

Contents

1. Introduction.....	2
2. Technology overview.....	2
3. Description or product family.....	3
4. IGBT static performance.....	4
5. IGBT dynamic performance.....	5
6. Power loss simulation in motor drive applications....	6
7. Selection guide.....	7
8. Abbreviations.....	8
9. Revision history.....	8
10. Legal information.....	9

© Nexperia B.V. 2023. All rights reserved

For more information, please visit: <http://www.nexperia.com>

For sales office addresses, please send an email to: salesaddresses@nexperia.com

Date of release: 3 July 2023
