

# Part No. 1005801

## 2.4 GHz Corner Chip Antenna

2.400 - 2.485 GHz

Supports: Wi-Fi applications, Bluetooth, BLE, Zigbee, WLAN, ISM

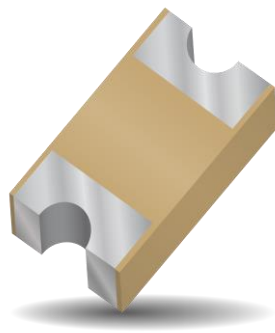

KYOCERA AVX chip antenna designed for corner placement on the PCB exhibits high efficiency for 2.4 GHz applications. It delivers the key needs to the device engineers for higher functionality and better performance in smaller and thinner designs. For support integrating, optimizing and testing this antenna in your device or custom designs, contact our Customer Support Team.

### 2.4 GHz Corner Chip Antenna

2.400 – 2.485 GHz

#### KEY BENEFITS

##### Stay-in-Tune

This chip antenna provides superior RF field containment, resulting in less interaction with surrounding components.

##### Quicker Time-to-Market

By optimizing antenna size, performance and emissions, customer and regulatory specifications are more easily met.

##### Environmental Compliance

Products are the latest RoHS version compliant.

#### APPLICATIONS

- Embedded design
- Headsets, Tablets
- Smart Home
- Wearables
- Handheld
- Telematics
- Tracking
- Healthcare

#### Electrical Specifications

Typical performance on 10 x 52 mm PCB

Frequency	2.400 – 2.485 GHz
Peak Gain	3 dBi
Average Efficiency	62%
VSWR Match	2.0:1 max
Feed Point Impedance	50 ohms unbalanced
Polarization	Linear
Power Handling	0.5 Watt CW

#### Mechanical Specifications & Ordering Part Number

Ordering Part Number	1005801
Size (mm)	1.00 x 0.58 x 0.35
Mounting	SMT
Weight (grams)	0.0009
Storage Temperature/ Humidity	15°C to 35°C / 65%
Operating Temperature	-55°C to +125°C
Packaging	Tape & Reel, 1005801 – 5,000 pieces per reel
Demo Board	1005801-01

**2.4 GHz Corner Chip KYOCERA AVX Embedded Antenna Specifications**  
 KYOCERA AVX produces a wide variety of standard and custom antennas to meet user needs

**Antenna Dimensions**

Typical antenna dimensions (mm)

Part Number	A (mm)	B (mm)	C (mm)
1005801	1.00 ± 0.10	0.58 ± 0.075	0.35 ± 0.10

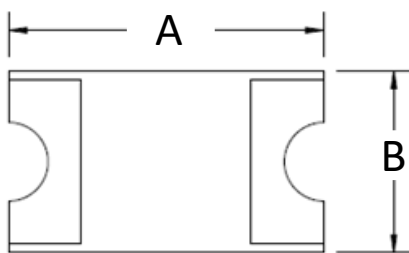
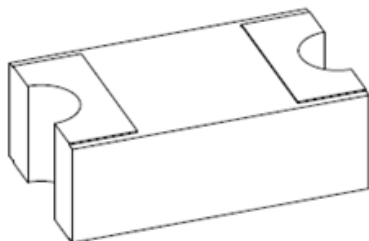

**Top View**



**Side View**

Pin	Description
1	Feed
2	Floating

\*Pin #1 and Pin #2 are interchangeable.

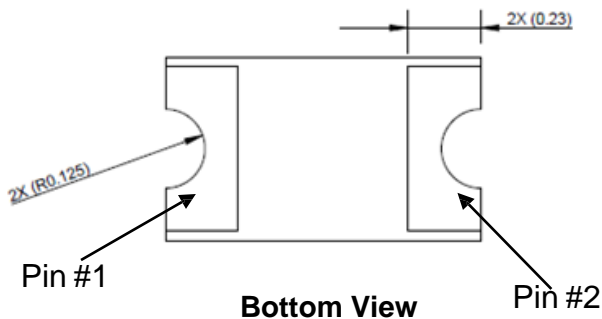

**Bottom View**

**2.4 GHz Corner Chip KYOCERA AVX Embedded Antenna Specifications**  
 KYOCERA AVX produces a wide variety of standard and custom antennas to meet user needs

**VSWR, Efficiency, and Peak Gain Plots**  
 Typical performance on 10 x 52 mm PCB

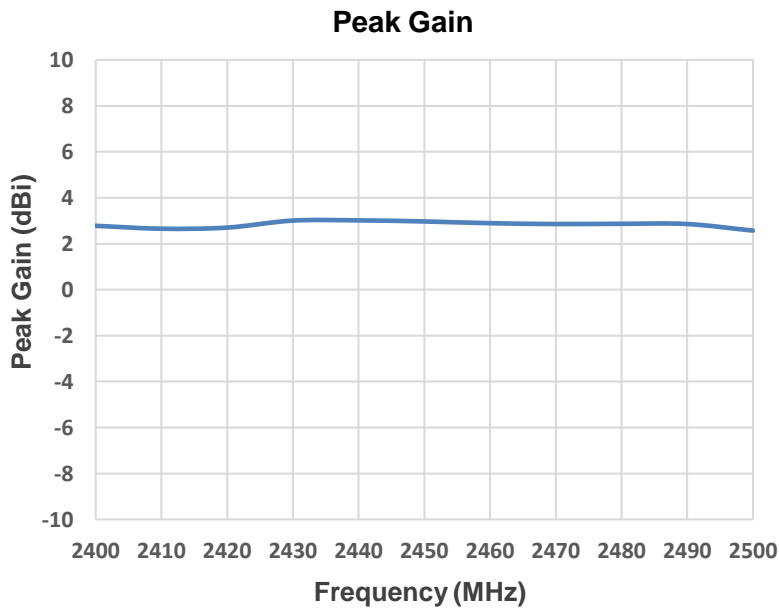
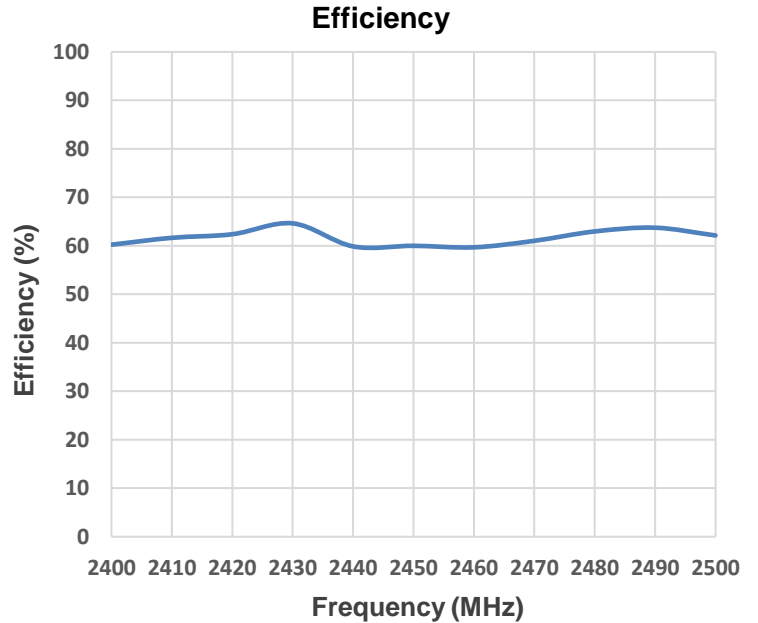
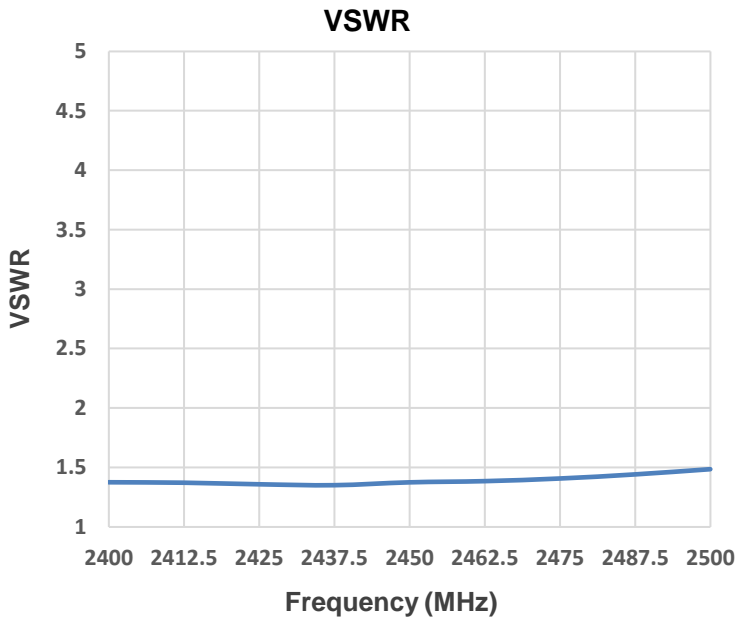

**2.4 GHz Corner Chip KYOCERA AVX Embedded Antenna Specifications**  
 KYOCERA AVX produces a wide variety of standard and custom antennas to meet user needs

**Antenna Radiation Patterns**

Typical performance on 10 x 52 mm PCB

Measured @ 2440 MHz

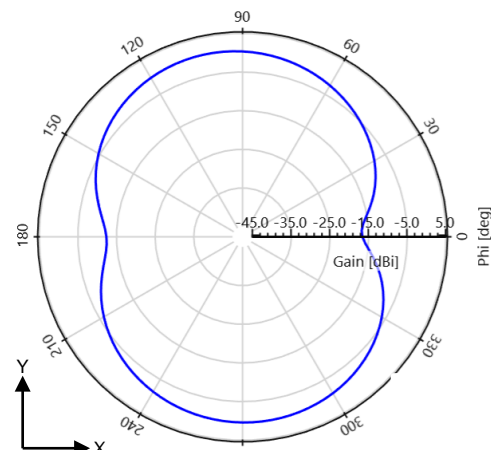
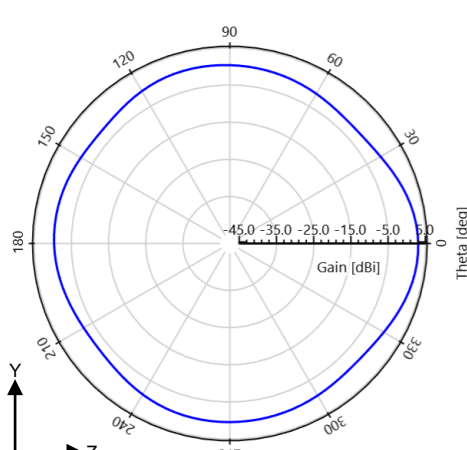
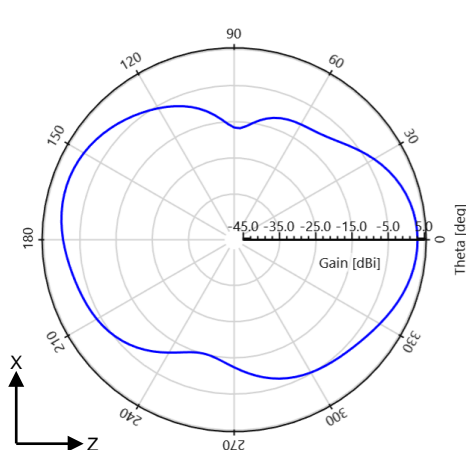
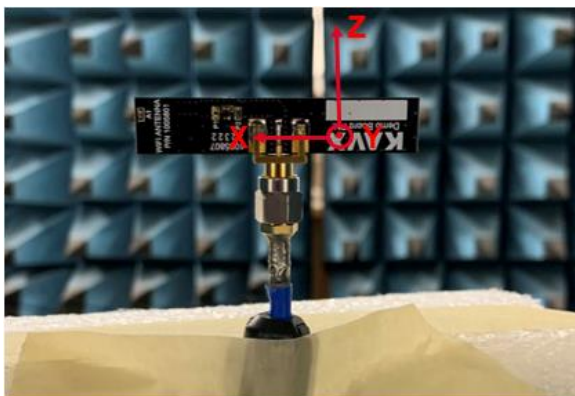

**2.4 GHz Corner Chip KYOCERA AVX Embedded Antenna Specifications**  
 KYOCERA AVX produces a wide variety of standard and custom antennas to meet user needs

**Antenna Layout (1005801-01)**

Typical layout dimensions (mm)

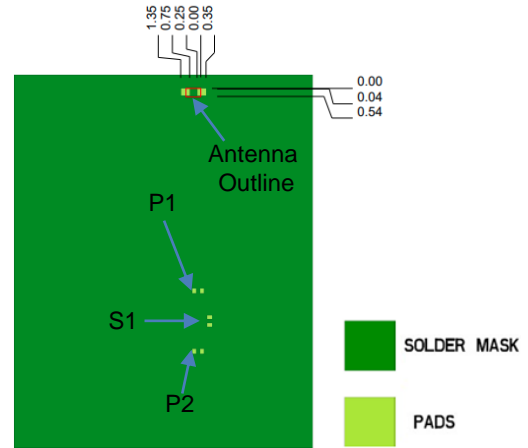
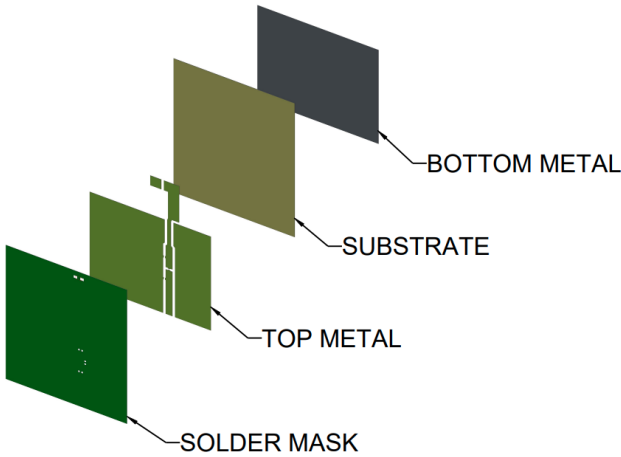

- \* Vias: Diam. 0.2mm, (no vias on transmission lines).
- \* Via holes must be covered by solder mask

**Pin Descriptions**

Pin#	Description
1	Feed
2	Floating

**Matching Pi Network (Demo Board)**

Component	Value	Tolerance
P1	DNI	N/A
S1	2.7nH	±0.1nH
P2	1.6pF	±0.05pF

Matching KAVX Part Numbers:

- S1: L02012R7BHSTR
- P2: 02015J1R6PBSTR

\*Actual matching values depend on customer's design.

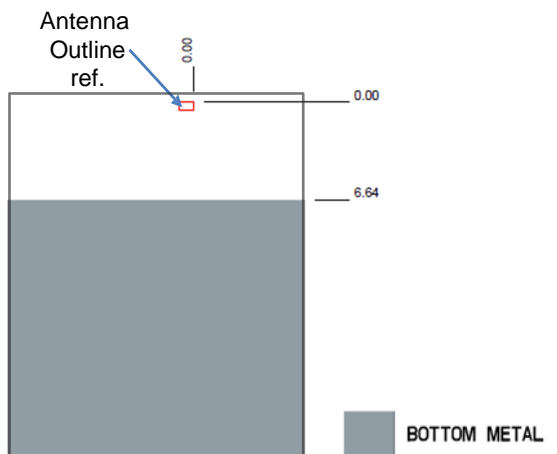
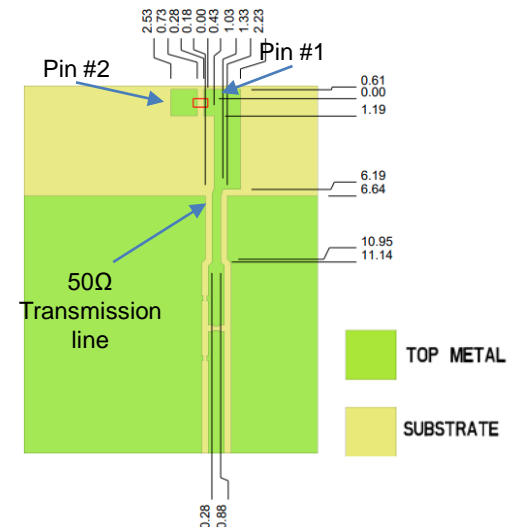
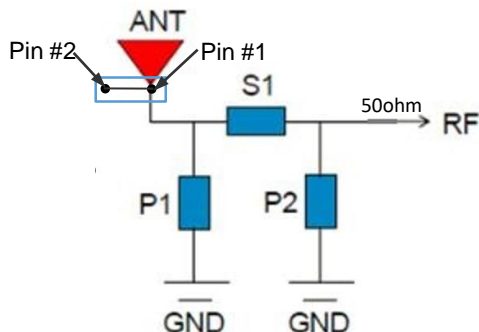

2.4 GHz Corner Chip KYOCERA AVX Embedded Antenna Specifications  
 KYOCERA AVX produces a wide variety of standard and custom antennas to meet user needs

**Antenna Demo Board**

Typical layout dimensions (mm)

Part Number	A	B
1005801-01	52.00 ± 0.20	10.00 ± 0.20

