



## Industrial IoT: from hype to reality

- 4** Evolution before revolution: the origins of Industry 4.0
- 12** Interview: creating gateways from the physical to the digital world
- 18** Turning IIoT into reality: digitalisation of the factory floor
- 28** The future of manufacturing

Focus is the quarterly magazine from Avnet Abacus, featuring in-depth trend and technology reviews, new product spotlights, Avnet community news and interviews with market leaders.

Avnet Abacus is a pan-European distributor committed to supporting customers from design to fulfilment. Our exceptional linecard features globally recognised manufacturers and an extensive product range that includes interconnect, passive, electromechanical, power supply, energy storage, wireless & sensor products and solutions.

## Features

- Evolution before revolution: the origins of Industry 4.0 **4**
- Turning IIoT into reality: digitalisation of the factory floor **18**
- The future of manufacturing **28**

## Interview

- Creating gateways from the physical to the digital world with Ruud van den Brink, Product Manager Industrial Communications EMEA at TE Connectivity **12**

## News

- Seven major brands name Avnet Abacus as their top distributor **34**

## Supplier technologies

- Future-proof your Industrial IOT applications with TE Connectivity **15**

## Connectors

- Hirose DF51 series, wire-to-board connectors **23**
- Harwin M225 series, high performance industrial connectors **23**
- Industry 4.0: the origins and outlook of manufacturing with Molex **24**

## Electromechanical

- Panasonic Electric Works DE series 16A relay **27**

## Passive

- Yageo CQ series MLCCs **9**
- Bourns RS-485 serial port – ESD/EFT/surge protection **9**

## Sensors, wireless and batteries

- Murata IOT solutions for smart buildings **16**
- Alps Alpine HSPPAD143A digital pressure sensor **32**
- Murata SCL3300 series 3-axis inclinometer **32**
- Omron D6T-32L-01A MEMS sensor **33**

If you have any comments or questions on the technologies featured in this edition, or wish to speak to one of our technical specialists, you can get in touch at [avnet-abacus.eu/ask-an-expert](http://avnet-abacus.eu/ask-an-expert)

Keep up to date with the latest news, product information and technical insights via our social media channels.



**Editor** Elinor Gorvett  
**Design** David Weber Design & Illustration  
**Print** Image Evolution

**We are on the cusp of the next industrial revolution. Technological advances in areas such as connectivity, sensing, processing, security and energy consumption are enabling the development of smart factories, with the promise of more efficient, adaptive and integrated production environments. In this edition of Focus magazine, we explore the path taken to reach the fourth industrial revolution and the benefits these advancements promise.**

In the first of three articles on Industry 4.0, Hagen Götze looks at the origins of automation and explains how rapid progress in areas such as robotics and 3D printing have led to the precipice of a manufacturing revolution.

We interview Ruud van den Brink, Product Manager Industrial Communications EMEA at TE Connectivity, to discuss TE's role in creating gateways from the physical to the digital world as well as exploring the part they are playing in driving industry standards such as IEC with other industry leaders.

In our second article on Industry 4.0, Marco Enge examines how design engineers are navigating the advances in technologies behind the Industrial Internet of Things, a key enabler for Industry 4.0, and how digitalisation of the factory floor is turning the potential of the IIoT into reality.

Finally, Martin Keenan looks to the future at how disruptive technology, linked through the IIoT, will transform how and where products are manufactured and envisions the path to a mature Industry 4.0.

We are already past the hype and amid this transformation in manufacturing we see exciting times ahead where our technology will help create a bright future for industry.



Rudy Van Parijs  
President, Avnet Abacus

# focus

A stylized, handwritten signature in white ink, appearing to read 'Rudy Van Parijs', with a long horizontal flourish extending to the right.



# Evolution before revolution: the origins of Industry 4.0

‘Manufacturing is entering  
a truly transformational  
period which will deliver  
the smarter and more  
connected factories of  
the future.’

## Hagen Götze

Director Supplier and  
Product Management  
Avnet Abacus



**We've come a long way from the days of Henry Ford famously telling customers that they could have the Model T car painted any colour 'so long as it was black' – a quote which reflected the compromise of having to put efficiency before choice.**

These days, modern car plants seamlessly manage demand for both volume and mass customisation by making vehicles with a multitude of different finishing options, often on the same production line.

It's a similar story of technological advancement across many other industrial sectors. In food and drink, for instance, greater connectivity and integration means production plants are now highly reconfigurable, meeting consumer demands for much wider variety and choice. And in pharmaceutical facilities, the emergence of personalised medicines has resulted in dramatic changes in manufacturing methods to cope with the need for flexibility.

This newfound adaptability is just one indicator of rapid change in the manufacturing sector in the era of Industry 4.0. The phrase, marking the start of the fourth industrial revolution, was first coined in Germany a decade ago to describe the convergence of technologies such as computers and

automation, along with intelligent and autonomous systems underpinned by data and machine learning. As more and more companies adopt Industry 4.0 methodologies, manufacturing is entering a truly transformational period which will deliver the smarter and more connected factories of the future.

### **Evolution before revolution**

But before we look at the potential of Industry 4.0, let's highlight some of the important milestones that have transitioned manufacturing from the limited performance of early factories through to the integrated production seen today. This transition represents an evolution spanning several decades. The adoption of the first industrial robots in the 1960s, followed by the development of the microprocessor and the computer ten years later, kickstarted the widespread introduction of factory automation across the manufacturing sector. The introduction of automation triggered the arrival of manufacturing at mass scale, with developing countries such as China, Japan and South Korea adopting new technologies, emerging as industrial behemoths with the size and technical capabilities to rival their Western counterparts. The lower labour costs and worker protections found in many of these countries provided ultra-competitive



Technology  
review

## Evolution before revolution: the origins of Industry 4.0

business conditions which resulted in their industrial bases expanding at an unprecedented pace.

### **SCADA changes everything**

But while automation levelled the playing field for developing countries, creating a globalised manufacturing sector, most companies were still taking a piecemeal approach to the way they used new technology. Typically, individual projects would be implemented on a case-by-case basis, with limited connection to other investments and therefore providing very little visibility of wider plant performance. It wasn't until the development and introduction of the first Supervisory Control and Data Acquisition (SCADA) systems – comprising sensors, conversion units, supervisory systems and a communication network – that a more joined-up approach was taken. The application of SCADA systems meant that data could be retrieved from factory assets and delivered in real-time to a centralised computer linked to human-machine interfaces. This enabled engineers to monitor and control assets, ranging from a single industrial plant to a network of facilities across a distributed area.

SCADA changed the game – democratising what had previously been siloed data from individual pieces of equipment and making it more meaningful for those charged

with improving plant performance. This meant industrial assets such as automation could be fine-tuned to run optimally, and thus with longer life, while reducing the opportunity for human error.

### **The emergence of IIoT**

Importantly, for many industrial organisations, the widespread implementation of SCADA systems heralded the start of a digital journey which continues today. As confidence grew, and a broader range and greater number of assets were connected, engineers became ever more comfortable with the idea of using digital technologies to increase operational efficiency and boost the bottom line.

Now, decades on from the introduction of SCADA systems, talk has turned to the Industrial Internet of Things (IIoT), a more open, standardised and scalable means of connecting physical devices and making the most of the data that they produce. It is important to point out that SCADA and IIoT shouldn't be viewed as competitive technologies. Generally speaking, information generated from SCADA acts as just one of the data-sets for IIoT, which combines enhanced connectivity and analytics to give a more rounded view of industrial performance.

So, where is IIoT starting to make a real impact with regards to factory automation? The early 'killer application', arguably, has been in the area of predictive maintenance. The development of smaller, faster and cheaper sensors means the list of 'things' that can be connected has grown exponentially over time, allowing plant engineers to record data around a whole host of parameters such as pressure levels, temperature, vibration, acoustics and flow. This data, combined with the power of

'The widespread implementation of SCADA systems heralded the start of a digital journey which continues today.'





**'Customers could have the Model T car painted any colour, "so long as it was black"'**

analytics, can be used to reveal telling patterns and problems within factory settings, or with installed equipment out in the field.

With machines and specialised sensors collecting data at every step of the way, the potential benefits of IIoT are huge. Instead of performing fixed schedules of maintenance, based on the periodic examination of equipment and mending of problems when faults occur, the IIoT is enabling companies to capture and analyse data, warning of potential problems before they result in downtime. This effective means of tracking of patterns to indicate failure can feed into the use of condition-based modelling, unleashing the potential of genuinely predictive maintenance programmes.

This trend is having a marked effect on the role of the maintenance professional. IIoT infrastructure and the introduction of new equipment such as augmented reality headsets means that roles that used to be about fixing assets have become more about stopping equipment from failing in the first place. Maintenance is becoming more proactive and is increasingly being viewed as a primary means of delivering competitive advantage.

Subsequently, manufacturers are investing greater resources in factory automation as a means of delivering continuous improvement in their maintenance activities.

But IIoT isn't just about maintenance. Increased connectivity and integration of industrial environments is also having an impact on the way that production line assets are designed and used. Take robotics, for instance: traditionally powerful robotic arms used on factory floors have been housed behind safety cages to protect workers. However, the latest generation of collaborative robots (cobots) features a suite of positional sensors, in combination with enhanced IIoT connectivity, that enables them to react to the presence of a worker in a split second. This development means that, in certain situations, cobots can be safely operated alongside human beings, creating more flexible production lines with greater levels of customisation.

Then there's plant transportation and logistics – another area where IIoT architecture is changing day-to-day operations. Increasingly, it is becoming common to see autonomous robots roaming factory floors, often as an

Technology  
review

focus





## Evolution before revolution: the origins of Industry 4.0

effective means of moving parts or goods around large facilities, improving efficiency through more effective route optimisation. A recent study from global professional services experts PwC said that 9 per cent of manufacturers have already adopted semi-autonomous or autonomous mobility within their operations and that this figure would double by 2021.

Of course, safety will remain of paramount importance as autonomous vehicle technology increasingly finds its way into industrial environments. Factory robots rely on sophisticated positional sensing, 3D camera systems, artificial intelligence and ubiquitous connectivity to enable them to navigate their way around the shop-floor reliably and unobtrusively. And it is only through the widespread application of robust and resilient IIoT systems that allows these vehicles to work in harmony with those around them.

### **Industry 4.0, a bright new future**

It's clear, then, that modern factories have come a long way from Henry Ford's vision of one product available in one colour only. Digital technologies now provide the operational backbone of all industrial facilities, characterised most recently through the emergence of IIoT as a means of providing real-time visibility and optimisation of maintenance, operations and logistics. The result is smarter factories benefitting from unprecedented levels of integration and connectivity.

So, where next? How will new technology and improved ways of working continue to propel manufacturers down their path to digital transformation? The answer comes in the form of Industry 4.0 – the collective term used to describe the wider convergence of connected systems, including IIoT, to drive future business benefit in manufacturing. Industry 4.0 is the logical step on from where we are today, pulling together many strands of rapidly emerging technologies such as 3D printing to further augment the ways that plants are operated.

Already, we are seeing Industry 4.0 methodologies driving the advent of new manufacturing trends such as mass customisation. Here, technologies such as cobots and additive manufacturing can be used to design and manufacture personalised products, with the efficiency of mass production. This opens up a new era of manufacturing, where technology can be applied to deliver previously unattainable levels of choice, ensuring that the customer truly is king.

Indeed, the upsides of Industry 4.0 cannot be overstated. By seamlessly managing the flows of Big Data, resulting in more informed real-time decision-making across an organisation, Industry 4.0 holds the promise of delivering the leaner and more productive factories of the future. And there are benefits across the lifecycle of what is actually being made. By enhancing connectivity, manufacturers will derive benefit from monitoring the performance of their products out in the field, improving repair and servicing performance, and driving new business models based on servitisation.

In short, with Industry 4.0 we stand on the precipice of a manufacturing revolution. And now is the time to capitalise on the enormous advantages it will bring.

'Already, we are seeing Industry 4.0 methodologies driving the advent of new manufacturing trends such as mass customisation.'





The CQ series of MLCCs for high frequency applications from Yageo has excellent temperature characteristics, a narrow tolerance of capacitance and even lower ESR (Equivalent Serial Resistance), Equivalent Serial Inductance (ESL), and dissipation factor than the standard NPO. The CQ series capacitors are offered in EIA case sizes from 01005 to 0805 and available in temperature stable NPO dielectrics with a capacitance range of 0.1 to 100pF, and rated voltage up to 250V.

While high Q capacitors provide high Q (low dielectric loss), low power dissipation with greater efficiency than standard MLCCs, the CQ series MLCCs are typically used in applications with high frequencies ranging from 500MHz to 10GHz. It applies copper, one of the best conductive metals, inner electrodes that allow for low ESR, low ESL, and high Self Resonant Frequency (SRF) in microwave frequency bands.



## FEATURES

- BME process with copper inner electrodes
- High Q and low ESR in VHF, UHF and microwave frequency bands
- Tight tolerance (min.  $\pm 0.05\text{pF}$ )
- Ultra low ESR and ESL

## APPLICATION

- Mobile front end
- Wireless networking
- Power amplifier
- NB and tablet
- M2M



For more information visit [avnet-abacus.eu/yageo](http://avnet-abacus.eu/yageo)

# Bourns RS-485 serial port - ESD/EFT/surge protection

TBU<sup>®</sup> High-Speed Protectors (HSPs) from Bourns provide protection against Electrostatic Discharge (ESD), Electrical Fast Transients (EFT), power and surge faults. For example, in RS-485 port protection, they provide excellent current limiting during surge events. However, TBU<sup>®</sup> HSPs are active components, and typically, occupying more board space than a passive component such as a power resistor. In some cases, a power resistor may be a more cost-effective and smaller substitute if surge levels are less severe.

## SOLUTION

- 2 TBU<sup>®</sup> HSPs: TBU-CA065-300-WH
- 2 MOVs: MOV-10D201K
- 1 TVS diode array: CDSOT23-SM712

## COMPLIANCE

- IEC 61000-4-2 ESD level 4 (8kV/15kV)
- IEC 61000-4-4 EFT
- IEC 61000-4-5 surge/lightning

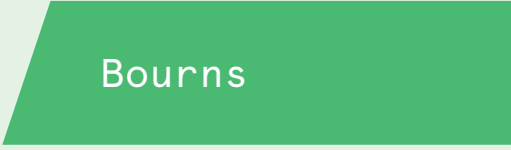

## ALTERNATE RECOMMENDATIONS

SMBJ6.5A and SMBJ12A TVS diodes with MF-RM012/240 Multifuse<sup>®</sup> PPTC resettable fuse

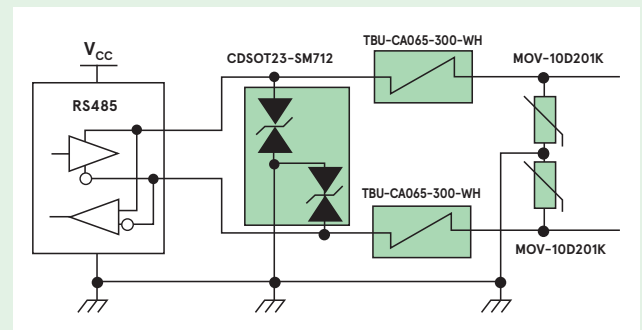

For more information visit [avnet-abacus.eu/bourns](http://avnet-abacus.eu/bourns)

# Panasonic

INDUSTRY



## We are Industry.

Our components breathe life into Industry 4.0. With over 100 years experience in manufacturing we know your business challenges. Use our expertise to make your customer happy.

#weareIN

For more information visit  
[avnet-abacus.eu/panasonic](http://avnet-abacus.eu/panasonic)

# POWER | PROTECT | CONNECT



**Bel Power Solutions AC-DC Power Supplies**

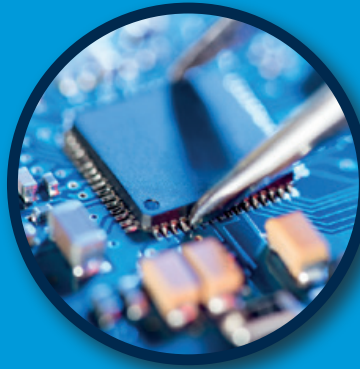

**Bel Fuse-Circuit Protection Fast Acting Fuse Series (0ADA, 0ADB, 0ADK, 0ADE)**



**TRP Connector Industrial Ethernet ICMs**



## TRP Connector

**MagJack® Industrial Ethernet ICMs** support 10/100Base-T non-PoE, PoE and 1GBase-T Ethernet applications for the industrial market for customers building equipment for factories and machines where the operating temperatures are between -40°C and 85°C and who need low cost, reliable ethernet connections.

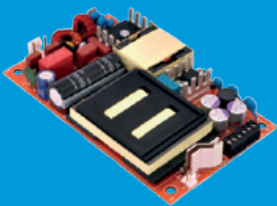

## Bel Power Solutions

**AC-DC Power Supplies** A wide universal AC input range of 90 – 264 VAC, from 40 to 1000 W of output power. High efficiency and high power density ensures minimal power loss in end-use equipment. Low-profile (under 1") height is ideal for use in a broad array of space-constrained applications.

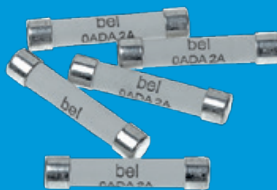

## Bel Fuse-Circuit Protection

**Fast Acting Fuse Series (0ADA, 0ADB, 0ADK, 0ADE)** For circuit protection in high energy and high power applications such as digital measuring instruments, industrial power supplies, DC-DC modules, power inverters, UPS, smart meters and 3-Phase AC-DC, but would also benefit from a smaller form factor than today's traditional fuses can provide.



POWER | PROTECT | CONNECT

For more information visit  
[avnet-abacus.eu/bel-fuse](http://avnet-abacus.eu/bel-fuse)

# Creating gateways from the physical to the digital world with TE Connectivity



## Interview: Ruud van den Brink

Product Manager Industrial Communications EMEA, TE Connectivity

**There's been a lot of discussion about the Industrial Internet of Things, and how it is underpinning the fourth industrial revolution (Industry 4.0). How much of that conversation is hype, and how much is a reality?**

We are already a long way past the hype stage. The Industrial Internet of Things – characterised by the use of sensors, software, connectivity and data analytics – is already transforming the way that modern factories operate, making them leaner, greener and more profitable. Indeed, research by IDC shows that manufacturing as an industry will spend around \$197 billion on IoT solutions in 2019, and that figure is expected to rise exponentially year-on-year. So, the Industrial Internet of Things is already here, and the challenge for organisations such as discrete manufacturers is to make the most of the advantages it brings.

Here at TE Connectivity, we have been on our own journey of digitalisation, shifting from analogue to digital operations within our factories as part of a broader transformation towards Industry 4.0 methodologies. That has meant thinking about how we link the physical to the digital world and coming up with gateways that

connect our equipment to the cloud. We have spent a lot of resources developing standard interface devices that do this in an effective manner, allowing us to make better decisions and process data on the edge.

**What are the key systems and technologies that are supporting the adoption of IIoT within the manufacturing sector?**

Advanced connectivity lies at the heart of it all, transforming devices, machines, and networks into integrated and responsive systems and technologies. Sensors have become smaller, cheaper and more effective, allowing the collation of data from pretty much any kind of asset within a factory. This information can be sent quickly and efficiently to the cloud, and, once combined with meaningful analytics, real meaning can be derived.

As we look forward, IIoT will continue to benefit from new technologies, such as the widespread introduction of 5G systems offering new levels of speed, latency and reliability, which will further enhance performance. A recent TE Connectivity survey of 180 senior engineers



Ruud van den Brink joined TE Connectivity in 2010 and is responsible for the management of the industrial communications product portfolio including business creation and new product development. As an international marketing and sales professional with 20+ years of experience in a B2B environment, Ruud has in-depth knowledge of a wide range of markets and technologies including semiconductors, MEMS, wireless communications protocols and fibre optics.



with a stated interest in consumer, industrial, and automotive IoT showed that 60 per cent of respondents believed that the advent of 5G would mean getting data faster and that, in turn, would result in new applications of all kinds for IoT. Also, artificial intelligence and machine learning will help us to make more sense of the data that is being created, allowing more intuitive decision making.

To make all this happen, manufacturers depend on an eco-system of products which allows for the provision of IIoT architecture. This includes the installation of miniature connectors, lightweight cabling, customised antennas, and multi-property sensors to improve, increase, and integrate data processing, power distribution, signal transmission, and wireless capacity.

**What do you see as some of the key areas of application for IoT-enabled architecture within manufacturing environments?**

Predictive maintenance has emerged as one of the primary areas of application, and it is already delivering results for many organisations. Monitoring sensor output

signals over days, weeks or even months can offer real insights into equipment performance. From bearing vibration to rising temperatures, operational trends can be plotted and analysed over time to enable manufacturers to predict when equipment failure is about to occur. This predictive approach to maintenance can eliminate unplanned downtime, boosting profitability.

**What sort of trends has the emergence of more advanced levels of factory automation created within the market for interconnects?**

There are two major trends that we see already. Firstly, the increased complexity of industrial networks brings a requirement for more sensors, actuators and other components, and that is resulting in a need for a rising number of nodes in manufacturing facilities, along with an increased number of interconnects. Secondly, with the need for more data, more and more of these nodes are becoming Ethernet/IP based. This allows for increased manageability in a network and also for additional data collection used to underpin IoT-enabled predictive maintenance regimes. Next to these two

‘TE is continuously scanning the market for interesting opportunities that cannot be addressed by the current set of standardised solutions. We must continue to look ahead and to be ready for the opportunities of the future.’

trends are the growing requirements for ruggedised solutions. Industrial facilities can be harsh environments, with vibration, humidity, heat and other ambient conditions. It is, therefore, crucial that components are designed to withstand the unique demands of industrial applications.

**Presumably, these factors have a significant impact on TE’s product line-up in areas like interconnects, wireless and sensing technology. How have you responded to ensure that you are playing a part in helping to deliver the factories of the future?**

The industrial segment is worth 30 per cent of TE’s business and IoT is an important part of the mix. The changing face of manufacturing is reflected in a constantly upgraded selection of products. In terms of circular connectors, for example, TE has the broadest portfolio on M8/M12. With production in China, we can reach the right cost point for the market while maintaining the quality as required. As such, we are the ideal one-stop-shop both for the device OEM as well as for the machinery makers and installer.

Also, our Mini-I/O is a ruggedised miniature solution used in industrial applications where the RJ45 cannot be used due to size or shock/vibration parameters. This solution is already standardised in IEC and adopted by several user organisations.

We also have a broad range of cable and board connectors, specifically for the industrial world. Board connectors are ruggedised and suitable for the latest assembly/solder processes. With regards to the cable connectors, they can be assembled without tools, and the wire cut of function prevents lengthy cable stripping work and guarantees maximum performance. Similar products will be introduced for M12 and Mini-I/O.

New technologies on the horizon include Single Pair Ethernet.

**What are the key challenges for design engineers and organisations looking to evaluate and adopt new technologies?**

For the newer technologies at the system and interconnect level, there needs to be a sustained drive towards greater standardisation, making life easier for the end-user. TE continues to play a central role here, driving standards such as IEC with other industry players. TE is also actively participating in various user groups including PNO, ODVA and Mechatrolink, staying connected with other industry players and driving the solutions needed in the industrial market. After this it becomes a matter of availability - from silicon, via connectors to cable. It is the responsibility of companies such as ours to ensure that the market is supplied with innovative and sustainable products that answer our customers’ ever-changing needs.

**The digitalisation trend makes it an exciting time for manufacturing. How do you see the future in terms of the pace of change within the sector?**

There is no doubt that manufacturing stands on the precipice of an exciting future, as enabling technologies like IoT, AI and cloud change drive the smarter factories of the future. Yet there is a need for some realism here, too. Historically, the industrial world has been a slow adopter of transformative technologies. So, I think that Industry 4.0 will be an evolution rather than a revolution, rolling out over the coming years rather than being implemented as an immediate change. Let’s not forget that the lifetimes of existing industrial builds can be decades, and extensions on such builds are usually based upon the same technologies - stretching the lifespan of these types of networks. This means that traditionally build networks will still be around for a long time.

That’s not to say that change isn’t coming. TE is continuously scanning the market for interesting opportunities that cannot be addressed by the current set of standardised solutions. We must continue to look ahead and to be ready for the opportunities of the future.

# FUTURE-PROOF YOUR INDUSTRIAL IOT APPLICATIONS WITH TE CONNECTIVITY

The Industrial Internet of Things, or IIoT, is all about extending the digital transformation of industry. This will go beyond existing machine-to-machine communication by allowing factories, suppliers and customers to share their digital knowledge to attain improvements in safety, quality and efficiency.



Industry 4.0 enables industrial engineers to add new capabilities to machines, such as the implementation of predictive maintenance, delivering deeper insights into logistics, and enabling simplified asset monitoring and management.

If you can view, track, monitor and measure big data, you can increase your productivity and effectiveness. For this to happen, you need safe, fast, reliable interconnection to transmit the data and sensors to collect the data.

**TE Connectivity is committed to working with engineers to push the boundaries of efficiency and productivity – enabling simpler, faster and more economic industrial communications – with a product portfolio that supports your IIoT designs.**



AUTHORIZED DISTRIBUTOR

## Connectors

Supporting ethernet communication with a broad range of ruggedised interconnect solutions including:

- M8/M12
- Mini-I/O
- RJ45

## Sensors

Vital to the next generation of data-driven technology, TE's range of pressure, position, temperature, humidity and vibration sensors provides the foundation for data collection that will help transform manufacturing floors into connected, cost-effective and reliable environments.

## Antennas

As market growth demands more antennas in smaller spaces, TE can help you navigate the complexity of antenna design, offering invaluable support to guide you to a solution that's right the first time.

## ARE YOU DESIGNING FOR THE INDUSTRIAL IOT?

Find out how to future-proof your application at:  
[avnet-abacus.eu/te-connectivity-iiot](http://avnet-abacus.eu/te-connectivity-iiot)

**AVNET** ABACUS



AUTHORIZED DISTRIBUTOR

# Murata IOT solutions for smart buildings

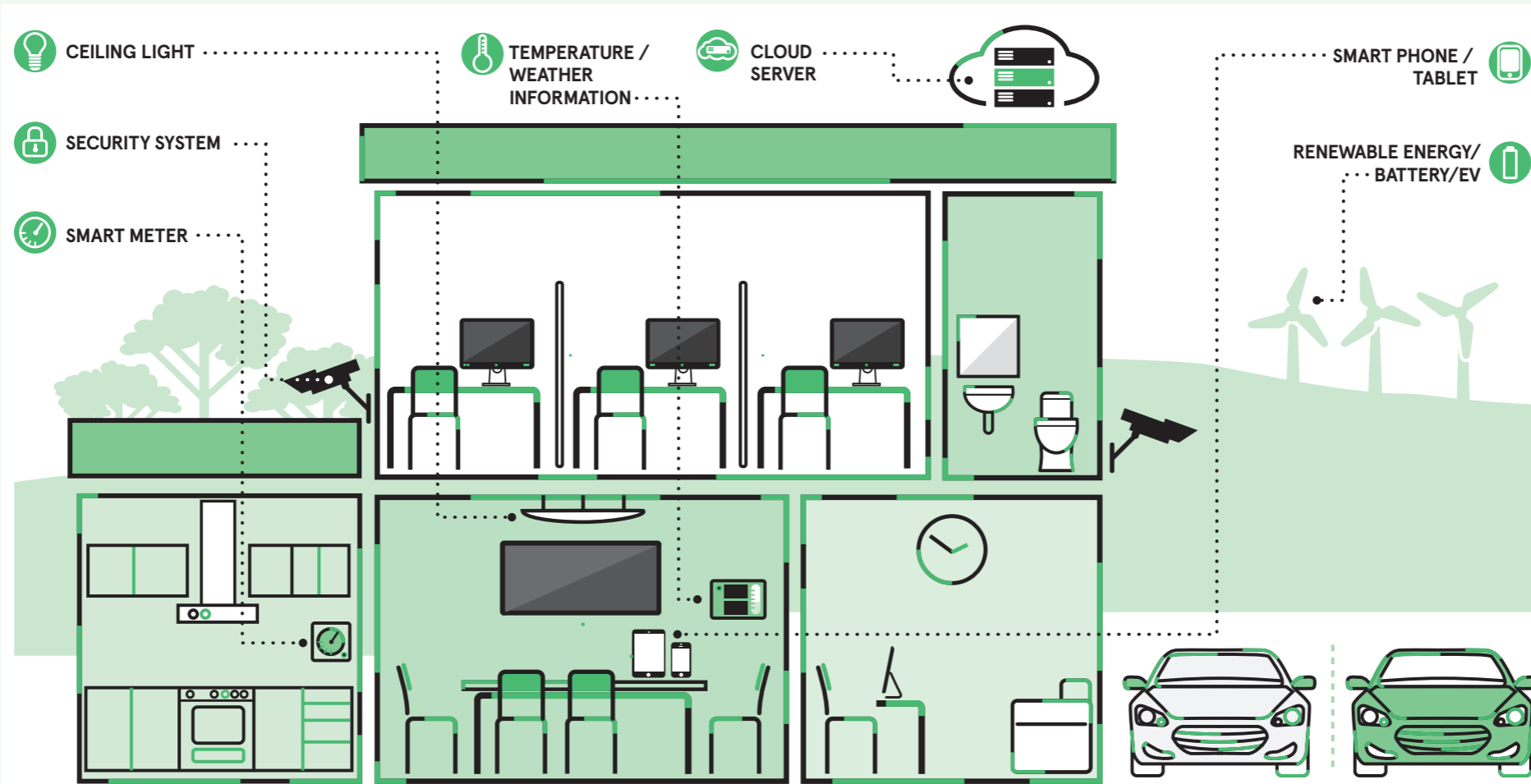

## A smarter way of life with Murata's wireless sensor network

Connected technology is changing the way we live. IoT solutions enable us to connect and automate building, technology, and energy systems, transforming the way our facilities are managed. Streamlining building automation processes, from heating and ventilation to air-conditioning and security, can reduce operating costs, improve

occupancy services, and minimise the building's impact on the environment. Whether at home or at work, Murata's innovation in wireless communication and sensor technology is contributing to a smarter, more productive and efficient way of life.

### Wireless communications

Murata provides RF components and modules for wireless communication applications, offering you an extensive range of products such as Wi-Fi, Bluetooth, LPWA, RFID, and many more.

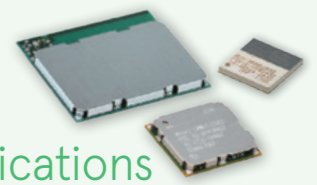

### Energy and power devices

Murata provides energy device solutions for IoT applications as follows;

- Micro batteries
- DC-DC converters



### Sensors

Murata offers an extensive range of sensors for IoT applications such as;

- PIR
- MEMS
- Ultrasonic

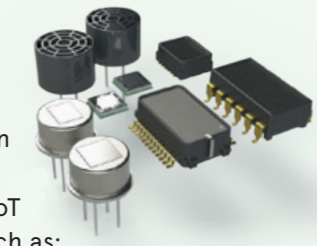

View the Murata webinar: **Designing motion detection systems with PIR and Ultrasonic sensors** and download data sheets at [avnet-abacus.eu/murata-smart-building-solutions](http://avnet-abacus.eu/murata-smart-building-solutions)



# Turning IIoT into reality: digitalisation of the factory floor

‘Ultimately, everything that can be connected will be connected, making IIoT potentially one of the most disruptive technology trends that manufacturing has ever seen...’

**While manufacturing companies come in all shapes and sizes, producing wildly different types of goods, it is perhaps surprising to find that many of them are confronted with the same range of day-to-day problems and challenges.**

What production manager hasn't worried about issues like quality, rework, rejects and waste? Plus, there are the underlying factors such as long lead times, excessive inventory and laborious setups – all of which can combine to create a litany of problems on the shop-floor.

Overcoming these all-too-familiar scenarios costs time, money and effort. That's why the manufacturing sector is increasingly looking at how digitalisation of the factory floor might lead to more effective ways of working.

This all-encompassing application of digital technologies is commonly referred to as the Industrial Internet of Things (IIoT). Primarily, it involves the combination of hardware, software, connectivity and data analytics, to give manufacturing companies much better visibility of their industrial assets, enabling them to enhance their processes.

The potential for IIoT is mind-boggling. According to research specialists Markets and Markets, tens of billions of devices will be connected over the next few years, representing a sector with a combined value of \$91 billion by 2023. This explosion in adoption is being driven by several factors, including technological advancements in automation, improved data rates and coverage of communication technologies and increasing use of cloud computing platforms.

Marco Enge

Senior Product Manager  
Avnet Abacus



Ultimately, everything that can be connected will be connected, making IIoT potentially one of the most disruptive technology trends that manufacturing has ever seen.

#### **IIoT in action**

So, what are the sorts of systems and components that need to be combined to provide reliable, scalable and cost-effective IIoT architecture? And what are the kinds of operational and business benefits that might be derived from connecting networks of industrial assets in such a way?

Firstly, there are sensors – representing the primary means of data collection from any industrial equipment. Wireless sensors, in particular, have

undergone rapid technological development in recent years, making them smaller and cheaper, and with better connectivity. These trends mean wireless sensors are ubiquitous in industrial environments, measuring a whole host of parameters such as current, flow, magnetism, motion, pressure and position.

Sensors represent a scalable and cost-effective method of producing valuable operational data, and they can be installed retrospectively to provide insight into the performance of legacy assets. It is now possible, for instance, to retrofit sensors to motors to measure vibration and temperature as part of predicted maintenance regimes.

## Understanding the cloud

But data collection is nothing without connectivity and analytics – and that’s where the rest of IIoT architecture comes in. The next technology enabler, after sensors, is the cloud, which acts as a means of delivering unlimited scalable compute power and storage capacity. For IIoT, the cloud’s offsite servers and networks represent a secure and robust platform for app development and analytics, which is crucial for making sense of the raw streams of data being produced.

In some cases, though, it makes sense to perform data processing and analytics nearer to the equipment on the factory floor – or edge computing as it is commonly known. This acts as a means of reducing the amount of information that needs to be sent to the cloud. A sensor-fitted motor, for example, would produce vast amounts of data daily, most of which would be within the parameters of operational norms. Edge computing offers a means of pre-processing and refining that data so that only information of real value is transmitted to the cloud for further analysis.

For manufacturers, edge computing brings several advantages. In mission-critical applications, edge computing can provide quicker identification of operational anomalies, as it reduces latency issues associated with the cloud. Some production facilities can be located in remote locations, where cloud connectivity might be unreliable or slow. Also, edge computing brings advantages for those firms who might not want sensitive IP-related data to be transmitted offsite.

## Enter machine learning

We’ve covered data collection, connectivity and storage – but what about data analytics? That brings into focus the role played by machine learning – effectively how algorithms can be used to analyse

data to make a model which can then be used to make informed decisions about the world. This ‘learning from the data’ can be taken a step forward into the principle of deep learning, whereby networks are capable of taking unstructured data to build new models in an unsupervised process.

Ultimately it is the development of machine learning and deep learning that will enable IIoT networks to manage and process information streams, resulting in the prediction of the behaviour of equipment using previously collected datasets. This opens up the possibility of a brave new world of smarter manufacturing, based on proactive rather than reactive techniques, spotting any problems before they occur.

The final piece in the jigsaw is the use of an Application Programming interface (API), which provides the building blocks for software development and acts as intermediary to the various services that are available on the cloud.

## Designing for IIoT

So, what sorts of considerations do design engineers need to make when it comes to choosing the right products and equipment for IIoT applications? Firstly, it is not enough simply to add connectivity to devices – the right kind of data needs to be gathered, transmitted, analysed and acted upon, and that requires certain building blocks to be in place. This requires selecting the right kinds of sensors, wired and wireless solutions, antennas, batteries and increasingly smaller connectors and passive components. It is also necessary to consider a host of other factors around end deployment, which might influence issues like size, weight, performance and interoperability.

There have also been some rapid advances in wireless connectivity in recent years, with technologies such

as LTE-M and NB-IoT emerging as decent connectivity options for IIoT installations. While LTE-M and NB-IoT are similar in that they are both Low-Power Wide-Area Network (LPWAN) technologies, they each have different operating attributes when it comes to factors such as latency and speed. These variances represent important considerations when deciding which technology is the best fit for deployment. Then there is 5G, whose high-speed connectivity and very low latency capabilities hold the potential for massive scale IIoT adoption. This will enable manufacturers to connect more devices, often in remote locations, with real-time network performance supporting safety-critical applications.



Indeed, there are options to be weighed up at every stage of IIoT development. Sensors are a case in point – choosing the right kind of sensor can have a big impact on IIoT installation success. Understanding sensing technologies is a crucial enabler of monitoring machine health in manufacturing environments, providing insight into factors such as temperature, force, rotation and position, alerting maintenance staff to pending failure.

However technological development in sensing has been rapid in recent years, as characterised by the transition from analogue to digital. This has resulted in a broad range of small, high-performance devices that can be integrated directly with microcontrollers or attached directly to digital industrial networks. The latest silicon etched microelectromechanical systems sensors can deliver excellent levels of measurement accuracy, while withstanding the sorts of operating environments commonly found in manufacturing facilities.

There has also been a big trend towards combined sensors, resulting in an increase in the number of



Technology  
review

focus

**‘In mission-critical applications, edge computing can provide quicker identification of operational anomalies, as it reduces latency issues associated with the cloud.’**



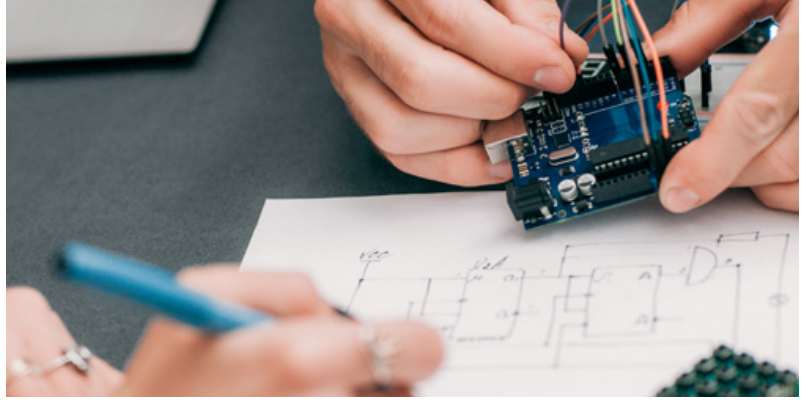

sensors embedded in a single device. Silicon-based temperature sensors can, for example, be embedded alongside the main sensor, providing short pathways and highly integrated electronics. This sort of configuration results in low noise emission while being protected against induced and emitted noise sources. Meanwhile, a single chip can now combine integrated analogue to digital signal conversion, power management and configuration functions. And the miniaturisation of silicon devices means today's digital sensors offer exceptionally low power consumption, which allows battery-powered and wirelessly networked installations.

**'The final piece in the jigsaw is the use of an Application Programming Interface (API), which provides the building blocks for software development.'**

Connectors are another crucial component in IIoT system development. In this case, design considerations include the size of devices, with space-saving products providing advantages when IIoT applications are required to be built into compact housings. Packaging considerations can also be answered through the combination of low-voltage power and data over a single cable and connection, as per the IEEE's Power over Ethernet (PoE) standard. Other connectors offer advantages when it comes to effective management of

electromagnetic interference, while some 'out-of-the-box' quick-fit designs are particularly good for ease of installation. Finally, customised connectors provide design engineers with a robust yet modular solution that is ideally suited for many heavy-duty industrial environments often found in robotic and automation applications.

### **Pulling it all together**

It is clear then, that the design engineer has many options to choose from when it comes to deploying IIoT. At times, successfully navigating this ever-expanding array of technology, while understanding how new connectivity technologies such as Time-Sensitive Networking (TSN) further supports the performance of IIoT, can seem a somewhat daunting task. Yet it can be achieved by working with knowledgeable and informed suppliers who can act as a one-stop-shop for industrial digitalisation.

Avnet Abacus can offer guidance and advice along the entirety of the value chain - from sensors, wireless modules and antennas, through to batteries and energy storage devices - with a depth of product range to match. In each case, it is about offering a holistic view of the technologies needed for the task at hand. Such a partnership reduces complexity, cost and risk, while ensuring that deployment challenges such as safety, redundancy and future proofing are fully met.

## Hirose DF51 series, wire-to-board connectors

HIROSE Electric Co. Ltd, a world-class manufacturer in connectors, introduced the DF51 series of robust wire-to-board connectors for applications requiring more strength and durability.

Featuring a side lock design, the DF51 series allows the connectors to be placed next to each other with wide widthways to save space on the board. The mating operation is user-friendly and a clear tactile click confirms secure engagement and a reliable connection.

Strong contact lance strength increases the contact retention in the housing and prevents the contacts from pulling loose if the cables are wrenched.

As well as offering many variations for design flexibility, the DF51 series is further polarised through the use of guide keys to prevent incorrect

mating. Single or double row versions are available in a straight, right angle or in-line housing with the option of gold or tin plating.

The DF51 series is part of the SignalBee product family. SignalBee consists of compact and high performance wire-to-board and wire-to-wire connectors that are designed for the requirements of industrial applications.

### FEATURES

- Number of contacts:  
1 row: 2-6 / 2 rows: 4-30
- Contact pitch: 2mm
- Current rating: 2A max.
- Voltage rating: AC-DC 250V
- Temperature: -55°C to +105°C
- Cable size: AWG 22-30
- Accepts resin sealing
- UL/C-UL certified

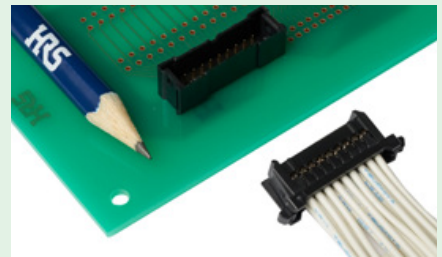

SignalBee

### APPLICATIONS

- Industrial machinery
- Medical devices
- Smart meters
- Industrial robots

For more information visit [avnet-abacus.eu/hirose](http://avnet-abacus.eu/hirose)

**HRS** HIROSE  
ELECTRIC  
EUROPE B.V.

## Harwin M225 series high performance industrial connectors

Capable of withstanding a 10G vibrational force for a period of six hours, the elevated performance, 2mm pitch M225 series from Harwin is designed to take on heavy vibrations and shocks. The compact and double row connector has a cable-to-board configuration accommodating a wide array of different wire sizes from 22AWG to 28AWG on the female contact.

Each tin-plated copper alloy male contact has a current rating of 3.0A when electrically loaded with a maximum contact resistance of 25mΩ. When mated, reliable interconnection is maintained, even when placed in the most uncompromising of settings and under extremely challenging working conditions.

The high-performance units feature a robust construction for prolonged operational lifespan, thanks to their glass-reinforced polyphenylene sulfide enclosures, with a 100MΩ minimum insulation resistance ensuring continued signal integrity. Featuring a rapid mate-before-lock retention system with expanding push pin rubber locking fixings for strain relief and additional vibration resistance.

For more information visit [avnet-abacus.eu/harwin](http://avnet-abacus.eu/harwin)

### FEATURES

- Compact design
- Innovative 3-finger stamped single-piece contact design
- Expanding rubber locking fixing
- Fast and secure connection between mated connectors, resistance to vibration
- EN9100 approval
- Flammability rating of UL94V-0
- Operating temperature of -55°C to +125°C
- Polarised housings with shrouded contacts
- Bandolier/carrier strip format for easy use on automated crimping systems

### APPLICATIONS

- Industrial
- Instrumentation
- Site control
- Robotics
- Mobile machinery

Harwin

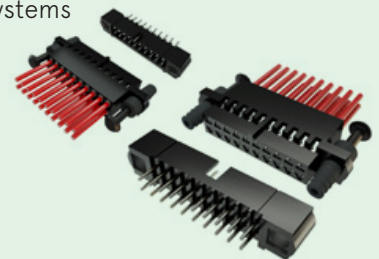

**HARWIN**

# Industry 4.0: the origins and outlook of smart manufacturing



Simply put, the now popular term 'Industry 4.0' refers to the next stage in the development of the manufacturing process. Whether you're familiar with the phrase the 'Industrial Internet of Things' or the fourth industrial revolution, there's one thing that these have in common – they allude to a significant digital transformation that ventures beyond the automation of production.

The first industrial revolution at the end of the 18<sup>th</sup> century introduced water and steam powered production. Since then manufacturing has reaped the benefits of the first assembly line and the first programmable control system, both enabling further automation and mass production. The fourth industrial revolution offers an even greater promise of freedom and flexibility across the factory floor.

The advancement of modular technologies is now making industrial machines and robotics more connected than ever before, leveraging increased intelligence and functionality. As new innovations change the devices, machines and people that fuel manufacturing, how will Industry 4.0 continue to revolutionise the manufacturing as we know it?

## HOW IS INDUSTRY 4.0 PROGRESSING?

If we think about the modern machine like a human body, a sophisticated computing device acts as the brain, with the framework (skeleton) supporting the machine. The combination of conveyors, motors, and robotics represents the muscular system of the body – these allow movement and 'circulation' around

the machine. The five senses are represented by the copious amounts of sensors that constantly assess the surrounding environment. At the core of the machine is the programmable logic controller (PLC), communicating inputs and outputs, and harmonising motion.

But how are each of these technologies and processes going to evolve with Industry 4.0? Some initial changes are already clear:

- Machine builders will begin to move away from PLC-centric devices that limit the scope for machine-to-machine (M2M) communication and remote access
- Manufacturing will require an increased use of sensors at every step in the process. These sensors will drive the communication of raw data and provide feedback to the control systems
- The next phase will make more use of distributed control systems, meaning each PLC within the network can coexist and communicate in real-time. With integrated security and safety, distributed control systems will improve efficiency and reduce response times

- Connected devices will be smarter than ever and easily accessible; the challenge will be programming them to optimise productivity, safety and efficiency

Just as the human nervous system connects the brain, spinal cord and sensory organs, the combination of power, signal and data points on a machine enables continuous communication. A particularly complex machine may have hundreds of these points, with each I/O requiring a stable connection to a panel or cabinet to ensure reliability. Molex's portfolio features a wide range of both in-cabinet power, signal and data solutions, as well as modular on-machine products.

IP67/IP68/IP69K rated, with seal technology that outperforms the seal reliability of traditional threaded connectors. Based on a circular M12 threaded-coupling design, Brad Hybrid Connectors integrate power and signal data lines, taking up less space in equipment designs.

**BRAD HARSHIO MODULES**

Brad HarshIO Modules provide a machine-mountable solution that supports all major industrial communication protocols and network systems, including PROFIBUS-DP, PROFINET IO, Modbus TCP, EtherNet/IP and DeviceNet. HarshIO Modules deliver status updates on network, power and I/O via diagnostic LEDs, and are compatible with the Brad M12 connector family. The IP67-Rated HarshIO Modules provide quick and reliable solutions for connecting industrial controllers to I/O devices in harsh environments where liquids, dust or vibration may be present.

**HEAVY DUTY CONNECTORS (HDC)**

Molex Heavy Duty Connectors deliver reliable performance in demanding industrial applications. These modular connectors are designed to protect against the ingress of water, dust and other potential contaminants on the factory floor.

**REVOLUTION OR EVOLUTION? TACKLING ONE MACHINE AT A TIME**

Whilst the term Industry 4.0 hints at a fourth industrial revolution, this is not an entirely accurate statement. Technology such as this changes or updates one machine at a time. Maintaining pace will mean overcoming any delays to migration and embracing the changes presented.

Whilst the technologies may be readily available, the focus should be on how manufacturers are positioning such technologies to transform the industrial automation market. Despite some solutions being readily available, the cautious approach of many manufacturers may lead to delays in improving automation systems. Challenges such as safety for workers and consumers, contamination prevention, adhering to regulations and critical environmental conditions may impact incentives to change.

The earlier industrial revolutions did not happen overnight, and Industry 4.0 is unlikely to break that trend. Regardless of whether the 'industrial internet' is referred to as evolutionary or revolutionary, the principles of Industry 4.0 are the natural next step to on-going improvements and innovation activities within the manufacturing industry.



**BRAD INDUSTRIAL AUTOMATION CONNECTORS**

Ruggedly designed to provide infrastructure solutions for harsh-duty manufacturing environments, Brad connectivity products provide solutions for industries such as food and beverage, material handling, automotive and commercial vehicles. Brad M12 connectors provide superior reliability in challenging environments, providing quality connections for control elements.

The Brad Ultra-Lock system is M12-compatible and provides a safe and reliable connection through patented 'push-to-lock' technology. This connection is

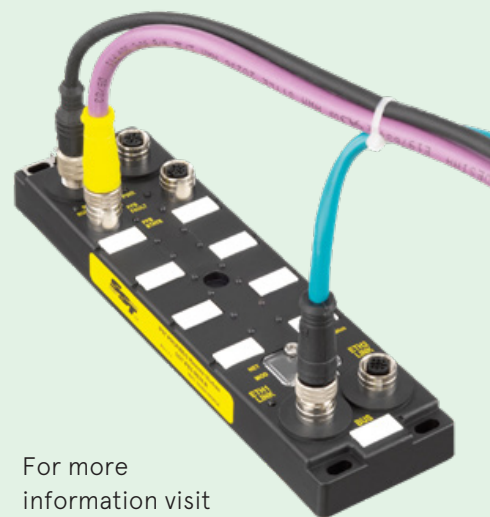

For more information visit [avnet-abacus.eu/molex](http://avnet-abacus.eu/molex)



# Engineers' Insight: the Avnet Abacus blog

## Solving design challenges

Avnet Abacus' technical blog, Engineers' Insight, is designed to help you solve key challenges across the breadth of markets and technologies we serve.

From electronics phenomena such as equivalent series resistance in electrolytic capacitors, to discussions on the best approaches to new wireless technologies, to in-depth design guides for power solutions, this is a blog written for engineers, by engineers.

### Where to read?

[avnet-abacus.eu/engineers-insight](http://avnet-abacus.eu/engineers-insight)

The DE series 16A polarised power relay from Panasonic is currently the smallest 16A relay on the market. The small footprint makes it ideal for applications such as smart sockets and smart plugs.

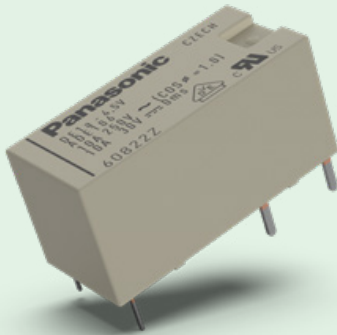

### FEATURES

- Conforms to European safety standards (VDE0700 and VDE0631)
- Clearance min. 8mm
- Creepage min. 8mm
- Extensive product line-up: Single side stable, latching 1 and 2 coils, contact configurations 1 Form A, 1 Form A 1 Form B, 2 Form A
- Surge voltage between contact and coil: 12kV
- Low operating power  
Nominal operating power 200mW (Single side stable, 2 coil latching)
- Compact size: 12.5 x 25 x 12.5mm (w x l x h)

- UL/CSA, VDE approved
- 16A contact rating possible for 1 Form A and 1 Form A 1 Form B

### TYPICAL APPLICATIONS

- Lighting
- IoT applications
- KNX bus applications
- Temperature controller
- Automatic meter reading
- Office Automation (OA) equipment
- Factory Automation (FA) equipment
- Power
- Security

## Example of use in a smart building lighting application

### AMORPHOUS SILICON SOLAR CELLS

- Different voltages
- Different substrates
- Outdoor and indoor types

### Charging the battery by harvesting solar energy

AM-5/AM-7/AM-8

### AMORPHOUS PHOTOSENSORS

- High sensitivity
- For reflow soldering

### Light measurement for functions like dimming

AM-30

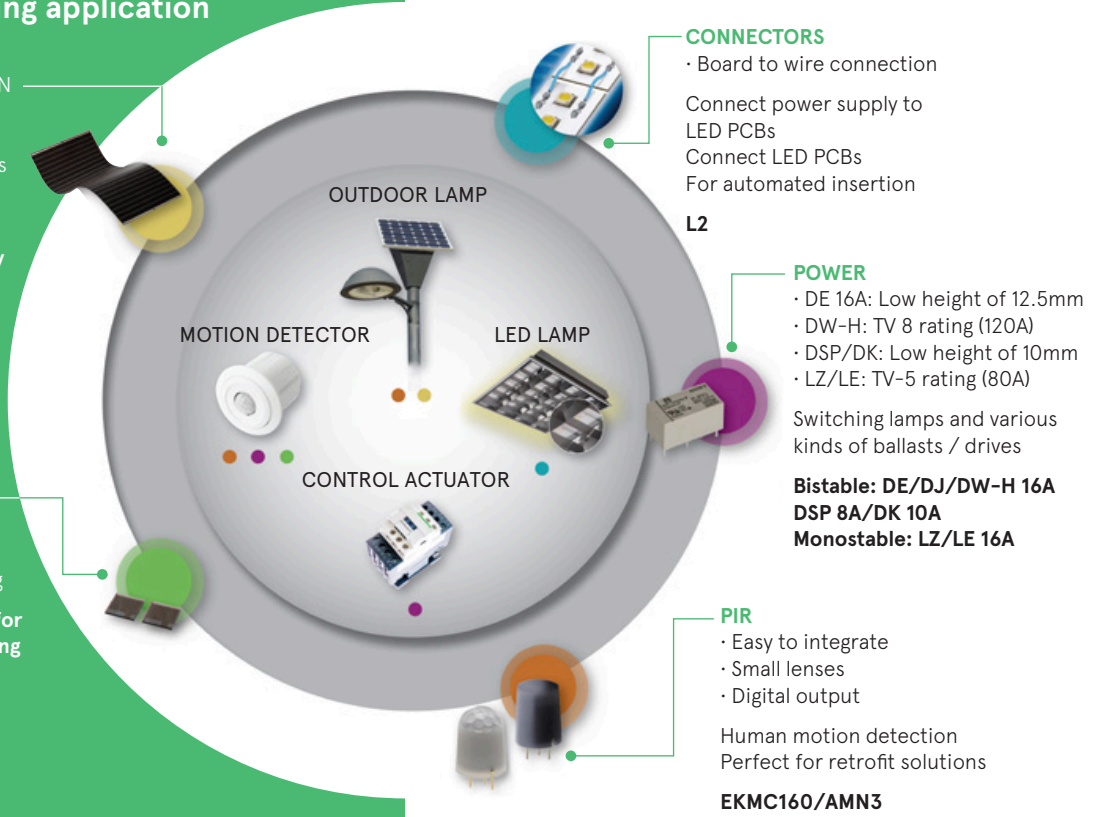

### CONNECTORS

- Board to wire connection
- Connect power supply to LED PCBs
- Connect LED PCBs
- For automated insertion

### L2

### POWER

- DE 16A: Low height of 12.5mm
- DW-H: TV 8 rating (120A)
- DSP/DK: Low height of 10mm
- LZ/LE: TV-5 rating (80A)

Switching lamps and various kinds of ballasts / drives

**Bistable: DE/DJ/DW-H 16A**  
**DSP 8A/DK 10A**  
**Monostable: LZ/LE 16A**

### PIR

- Easy to integrate
- Small lenses
- Digital output

Human motion detection  
Perfect for retrofit solutions

**EKMC160/AMN3**

# The future of manufacturing

**'Digital twins provide unprecedented levels of visibility, acting as crucial enablers of Industry 4.0 and the smarter factories of the future.'**

**These are exciting times in the manufacturing sector, with digitalisation helping to transform the way that new products are designed, built and sold. Across the value chain - from innovation and production, through to logistics and supply - companies are applying digital technologies to help them become faster and more flexible. This, in turn, is driving productivity and profitability, which boosts the bottom line.**

Having looked at the origins of automation and the emergence of Industry 4.0, and then at some of the design engineering challenges of implementing digital projects, we now provide a snapshot of a brave new world of manufacturing. How will the great work that engineers and new equipment developers have achieved in industrial IoT change the way that

products are designed, built and operated? What connected and integrated technologies will enable manufacturers to work smarter and become more efficient?

## **Digital twins leading to optimised plants**

Engineers have always used software to underpin their activities, with programs such as CAD, FEA and CFD providing critical insight into product design. But as IIoT networks comprising automation, sensing and connectivity have proliferated across all aspects of industry, there are new opportunities to use digital data to underpin a far broader range of activities, from design and engineering through to production and operations. These opportunities are encapsulated in the concept of the digital twin - a

Martin Keenan

Technical Director  
Avnet Abacus



virtual representation of real-world products or assets – which can be continuously maintained through real-time updates.

Digital twins can be applied at different levels, depending on the specific requirement of the organisation in question. At the most basic level, it can focus on just one critical component within a production process, enabling engineers to drill into very detailed design and performance data. The application can be raised up a level to give insight into assets or systems, and further still up to processes, covering the entire lifecycle of a product.

In short, digital twins provide unprecedented levels of visibility, acting as crucial enabler of Industry 4.0 and the smarter factories of the future.

### **Cobots and 3D printing boost mass customisation**

We are also seeing some exciting trends developing on the production line, as engineers apply their knowledge in innovative new ways. Take automation – which has been around for decades in the form of robotics and other mechanised processes. For a long time, it was felt that automation would one day lead to the ‘lights out’ factory, with production lines rolling 24/7 without a human in sight. That hasn’t proved to be the case. Instead, what’s happening, is that the adoption of new digital technologies is making factories more collaborative – with man and machine working in closer unison.

This is characterised by the emergence of a new breed of collaborative robots (cobots) – soft-skinned

robotic arms that are fitted with a suite of sophisticated sensors that allows them to be taken out from behind safety cages and positioned alongside workers on the production line. By bringing people and technology closer together, cobots and workers can combine more effectively to add specific features and capabilities to the products that are being made. This enables manufacturers to meet the growing demand for mass customisation without having to extend their lead times.

3D has a role to play here, too. The quality and consistency of additive metal and polymer parts have improved dramatically in recent years, and 3D printers are now a common sight on factory floors. It is a technology that can further bolster mass customisation techniques, acting as a flexible means of creating personalisation of products. Already, audio equipment makers are using 3D printing to produce earphones that are the perfect fit, while healthcare manufacturers are using it to develop personalised orthopaedics.

Indeed, cobots and 3D printing are an excellent example of how the application of digital technologies can result in faster and more flexible ways of working while deriving additional benefit for the end customer.

### **Feedback loops can produce perfect designs**

These examples are on the production line, but other exciting things are happening along the value chain. Previously, many manufacturers placed most of their emphasis on their design and production activities, losing sight of how their products performed out in the field. Now, the combination of smaller and cheaper sensors with widespread connectivity means valuable data can be collected from product design all the way through to end of life. That means manufacturers have better visibility of real-world performance, and this new insight enables them to make the most of feedback loops.

That means any performance issues and shortcomings can be identified and rectified through a more fluid process of re-design. That process is increasingly being supported through the use of emerging technologies such as additive manufacturing, allowing manufacturers to make changes and test the performance of new parts in a shorter timeframe than would previously have been possible. It is about being driven by data and using that insight to improve functionality to meet customer need.

### **The connected worker at the heart of smarter factories**

Digitalisation is driving more customer-centric business models in other exciting ways. Virtual Reality (VR), for example – historically the preserve of the gaming industry – has started to find its way into industrial settings. Initially, the primary use case was training, with VR headsets being used to give workers experience of a wide range of complex and dangerous scenarios in a simulated environment. This practice encourages better real-world decision making and drives safer business operations.

**'The future of manufacturing has never been more exciting, with perhaps the application of IIoT and Industry 4.0 only constrained by the limits of our imagination.'**

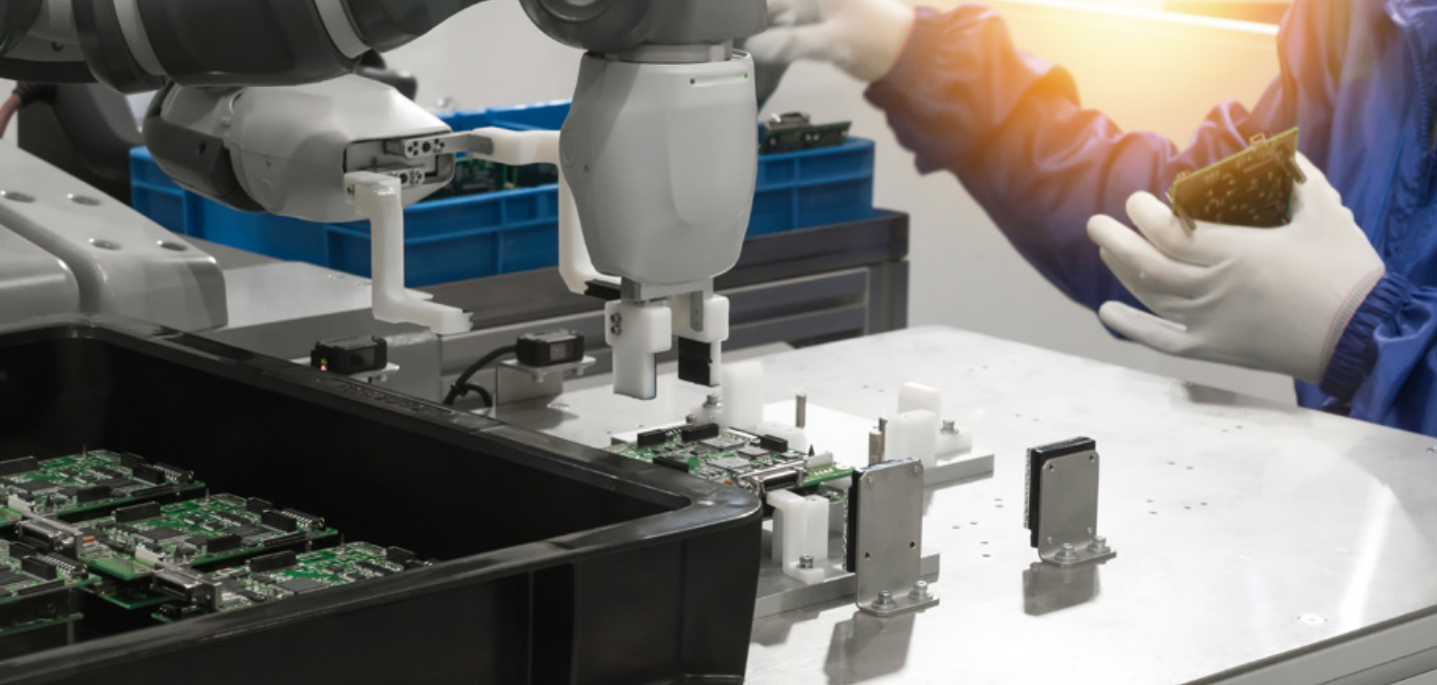

More recently, though, Augmented Reality has entered the fray. Augmented Reality (AR) differs from virtual reality in that it provides a 'mixed' view on the world, with headsets used as a means of superimposing digital information over physical assets in a worker's line of sight. For manufacturers, that visual capability provides an immense opportunity in maintenance applications, both when repairing equipment inside their factories and when servicing equipment out in the field.

Instead of working from paper-based repair manuals, maintenance workers can receive far more data-rich information such as interactive drawings and exploded schematics, allowing repairs to be concluded in a faster manner. Also, if that maintenance worker cannot deal with any particular issue, remote assistance can be provided via the headset, with other members of the team helping to guide the repair activities.

What we are seeing here, is the emergence of the truly connected worker – driven by data and IIoT. In the future, this connected concept will accelerate, with workers increasingly utilising the benefits of wearables such as exoskeletons fitted with movement and activity trackers that allow them to perform their roles more comfortably and efficiently. Data can be taken from these devices over time to further refine their assistive capabilities. The connected worker is also being extended to the relationship between individuals and specific pieces of equipment. The aircraft maker Airbus has, for example, been trialling connected power tools such as drills which recognise the role that each worker is expected to perform, and automatically adjusts torque and angle settings to

match. This streamlines processes and reduces the chance of human errors.

### **The era of service-based business models**

The use of digital technologies is also starting to lead to new business models based on the concept of 'servitisation'. Here, manufacturers don't necessarily sell a 'product' in the traditional sense: instead, they sell a service based upon specific performance metrics such as, say, uptime.

The concept of servitisation has been pioneered across the industrial sector. In aerospace, for example, engine suppliers such as Rolls-Royce have long-since sold 'power by the hour'. Meanwhile, some walkway, elevator and escalator companies have built revenues based on the availability of service, rather than the number of actual products sold. Again, it is about using connectivity and data to provide better visibility of asset performance. This drives more profitable contracts over the longer-term, avoiding the peaks and troughs of single item big-ticket sales.

### **In conclusion, the future is bright**

As we can see, digitalisation is transforming manufacturing at every point in the value chain. Whether it is improving asset visibility, increasing production flexibility, reducing downtime, or driving out waste, the connected landscape is helping manufacturers to improve productivity and better meet their customers' needs. This all means that the future of manufacturing has never been more exciting, with perhaps the application of IIoT and Industry 4.0 only constrained by the limits of our imagination.

## Alps Alpine HSPPAD143A digital pressure sensor

The HSPPAD143A digital pressure sensor from Alps Alpine has a waterproof design for barometer and water depth measurement systems. Barometric and water pressure is detected by a MEMS sensor element using a piezoresistive bridge circuit formed on the silicon diaphragm. The sensor element is connected to an Application Specific Integration Circuit (ASIC) for signal conditioning which has 17-bit Analogue to Digital Converter (ADC) and temperature compensation capability. In addition to the ASIC output compensating pressure values, the HSPPAD143A supports averaging and filtering for lower noise, and FIFO function. The I2C interface is prepared for communication.

### FEATURES

- Pressure range: 300 hPa to 2100hPa ( +9000m in altitude and 10m in depth )
- Supply voltage: 1.7V to 3.6V (typical 1.8V)
- Operating temperature: -40°C to +85°C
- Package: small LGA package: 3.1 x 3.1 x 2.6mm (l x w x h)

## Alps Alpine

- Digital interface: I2C
- Current consumption: 1.8uA (low power setting)
- Noise RMS: 0.026hPa (high resolution setting)
- Sampling rate: 200Hz max (continuous mode)
- Lead free, RoHS instruction, halogen free conforming

### APPLICATIONS

- Wearable devices
- IoT equipment
- Flow meters

For more information visit [avnet-abacus.eu/alps-alpine](http://avnet-abacus.eu/alps-alpine)

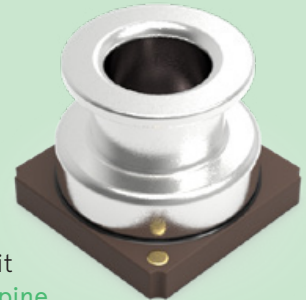

# ALPSALPINE

## Murata SCL3300 series 3-axis inclinometer

The high performance SCL3300 series from Murata is targeted at applications demanding high stability in tough environmental conditions. Signal processing is done in a mixed signal Application Specified Integration Circuit (ASIC) with flexible Serial Peripheral Interface (SPI) digital interface. The sensor element and ASIC are packaged into 12 pin pre-moulded plastic housing that guarantees reliable operation over the product's lifetime. The SCL3300 series has extremely stable output over wide range of temperature and vibration and along with several advanced self-diagnostics features, is suitable for SMD mounting and compatible with RoHS and ELV directives.

### FEATURES

- 3-axis (XYZ) inclinometer
- User selectable measurement modes:
  - 3000LSB/g with 70Hz LPF
  - 6000LSB/g with 40Hz LPF
  - 12000LSB/g with 10Hz LPF
- Angle output resolution 0.0055°/LSB
- -40°C to +125°C operating range

## Murata

- 3.0V to 3.6V supply voltage
- SPI digital interface
- Ultra-low 0.001°/√Hz noise density
- Excellent offset stability
- Size 8.6 x 7.6 x 3.3mm (l x w x h)
- Proven capacitive 3D-MEMS technology

### APPLICATIONS

- Levelling
- Tilt sensing
- Machine control
- Structural health monitoring
- Inertial measurement units (IMUs)
- Robotics
- Positioning and guidance systems

For more information visit [avnet-abacus.eu/murata](http://avnet-abacus.eu/murata)

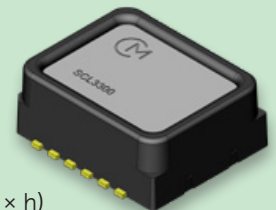

# muRata

INNOVATOR IN ELECTRONICS



The new ultra-wide angle version of the D6T series MEMS thermal sensor from Omron with a broad view across 90° by 90°, is able to encompass a wide area such as a whole room from a single viewpoint. This high performance sensor offers contactless measurement of temperatures of 0°C to +200°C in ambient temperatures of -10°C to +70°C.

The space saving design of the D6T, at only 14 x 8 x 8.93mm for the largest 32 x 32 element version, makes it exceptionally well suited to temperature detection in a wide range of Internet of Things and other embedded applications.

**Cross-section view of D6T sensor**

- Silicon lens**  
Far-infrared focusing
- MEMS thermopile**  
Electromotive force occurrence
- ASIC**  
Low noise amplifier
- MCU**  
A/D conversion, calculation, I2C and I/F

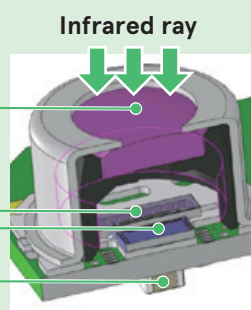

Detect wavelengths in the range 8-12µm

**FEATURES**

- 90° x 90° viewing angle
- High resolution 32 x 32 (1024 elements)
- Temperature converted output with an external microcomputer
- Highly accurate
- Compact size
- Easy connection
- Low noise

**APPLICATIONS**

- Object detection
- Industrial equipment
- Building automation
- Data centre
- Human detection
- Home appliances
- Security cameras
- Home automation

View the Omron webinar: **Selecting the right sensing solutions for IoT and smart city applications** and download data sheets at [avnet-abacus.eu/omron](http://avnet-abacus.eu/omron)



# Seven major brands name Avnet Abacus as top distributor

Avnet Abacus is frequently recognised as the best performing distribution partner for leading brands, and 2019 has been particularly successful. Ten awards in six months show how Avnet Abacus is recognised for excellence in distribution and valued by suppliers with a broad range of objectives and diverse ways of assessing their partners' performance.

At its annual distribution summit in April, **TE Connectivity** named Avnet Abacus as its '2018 Distributor of the Year' for the EMEA region. This is based on Avnet Abacus' overall performance with special attention to key criteria including growth in sales and the development of new designs and projects, as well as delivering training based around the leading-edge products and technologies offered by TE. A second award, for 'Competitive Conversion', was given in recognition of Avnet Abacus' strong success in winning new business for TE products in competition with distributors offering solutions from alternative manufacturers.

'Our supply partners rightly expect top performance, and we deliver our maximum every day.'

Later that month, at the **Molex** annual EMEA distribution summit, Avnet Abacus received the EMEA Distributor of the Year award for the third time in succession. Molex's assessment is based on the number of new projects that result in design registrations and conversion, as well as sustainable sales growth achieved both



TDK European Distribution  
Gold Award, Munich,  
Germany, July 2019

through training and investment in technical knowledge and NPI (new product introduction). At the summit, the Avnet Abacus regional sales and marketing teams won two further awards including Regional Distributor of the Year for the North (UK and Nordic) and Regional Distributor of the Year for France, Benelux and South Africa.

**TDK** benchmarks distributor performance against several metrics including inventory management, contractual terms, business performance, and operational excellence. The scoring system compares different distributors as well as individual improvements year-on-year. Scoring 885 points from a maximum 1000 – exceeding the 2018 total – Avnet Abacus excelled in all categories to win TDK's European Distribution Gold Award in July.

The same month, **Omron** named Avnet Abacus 'Best Distributor for the Central Region 2018'. The electromechanical and sensing technology leader analyses a wide range of criteria including year on year sales growth, customer visits, sales quotes, conversions, and new design projects. Omron's European Distribution Manager Hafeez Najumudeen praised Avnet Abacus' operational efficiency and the sales growth achieved. The coming year will prioritise even deeper collaboration on new opportunities from initial design to logistical support.

Finally, for July, **Vishay** presented a special award to Avnet Abacus – 'Fastest Growing Passive Distributor from 2016 to 2018' – recognising long-term commitment that has delivered enduring success. The keys to winning this award are found in Avnet Abacus' innovations that make it easy for customers to specify and buy Vishay components. The full Vishay product portfolio contains over one million part numbers, so helping customers choose the right parts for their projects is critical.

**Harwin** is rapidly expanding its range of connectors including new high-reliability parts and EMI-shielding products. Avnet Abacus has shown it can adapt to support the fast pace of innovation and grow the customer base, winning new customers in sectors such as industrial, defence, robotics and aerospace. Outstanding successes secured the 2019 Harwin Sales Excellence Award, which was presented in August by Harwin's Managing Director, Andrew McQuilken.

Molex European Distributor of the Year, Windsor, UK. April 2019



More recently, in September, **Panasonic**, a leader in battery technologies, awarded Avnet Abacus 'Battery Distributor of the Year' 2019 for its excellent performance including understanding how to promote innovative battery chemistries and delivering overall business growth. Winning this award for the second year in succession highlights the specialised technical knowhow, backed up by expertise in logistics and supply chain management, that Avnet Abacus brings to every relationship with every supplier and every customer.

Alan Jermyn, Vice President of Marketing at Avnet Abacus, puts it all in perspective. '**Our supply partners rightly expect top performance, and we deliver our maximum every day through our broad and deep technical understanding, our outstanding sales organisation, our expertise in logistics and supply chain, and our unrelenting commitment.**'

Can you sense  
the potential?



Developments in pressure sensors are  
enabling a range of new applications.

Make sure your knowledge is up to date  
with The Design Engineer's Guide

[avnet-abacus.eu/pressure-sensors](http://avnet-abacus.eu/pressure-sensors)

AVNET<sup>®</sup> ABACUS