

# Part No. AP822601

## Automotive Universal Broadband FR4 Embedded LTE / LPWA Antenna

698 – 960 MHz / 1710 – 2200 MHz / 2300 – 2400 MHz / 2500 – 2700 MHz / 3300– 3800 MHz

Supports: Broadband LTE (OCTA-BAND), LTE CAT-M, NB-IoT, SigFox, LoRa, Cellular LPWA, RPMA, CBRS



### Broadband FR4 Embedded LTE/LPWA Antenna

698 - 960 MHz  
 1700 - 2700 MHz  
 3300 - 3800 MHz

#### KEY BENEFITS

##### Reduced Costs and Time-to-Market

Standard antenna eliminates design fees and cycle time associated with a custom solution; getting products to market faster.

##### Greater Flexibility with Unique Form Factors

KYOCERA AVX's technology helps you deliver more advanced ergonomic designs without adverse impact on product performance.

##### Reliability

Comply with latest RoHS requirements

#### APPLICATIONS

- Medical applications
- Home automation
- Smart metering
- M2M, Industrial devices
- IoT
- Firstnet
- Automotive
- Healthcare (FDA Class I) Applications
- Point of Sale
- Tracking
- NB-IoT
- Sigfox
- LoRa
- Cellular LPWA
- RPMA
- LTE CAT-M

KYOCERA AVX A-Series automotive antennas deliver on the key needs of device designers for higher functionality.

KYOCERA AVX has completed rigorous testing to qualify the A-series antennas for automotive applications. Although the AEC-Q200 standard does not include antenna products, all testing has been done following applicable AEC-Q200 requirements and procedures as closely as possible. Customers must provide additional quality requirements, if any, to drive additional compliance testing.

### Electrical Specifications

Typical AP822601 performance 140 x 50 mm PCB

Frequency (MHz)	698-960	1710-2200	2500-2700 (B7)
Peak Gain	2.6 dBi	4.4 dBi	3.4 dBi
Average Efficiency	68%	76%	52%
VSWR Match	< 2.5:1		< 2.5:1
Polarization	Linear		
Power Handling	2 Watt CW		
Feed Point Impedance	50 Ω unbalanced		

Frequency (MHz)	2300-2400 (Band 40)	3300-3800 (n78)
Peak Gain	1.8 dBi	2.8 dBi
Average Efficiency	46%	59%
VSWR Match	< 3.0:1	< 2.5:1
Polarization	Linear	
Power Handling	2 Watt CW	
Feed Point Impedance	50 Ω unbalanced	

LTE/LPWA Universal Broadband Embedded Automotive Antenna Specifications.  
 KYOCERA AVX produces a wide variety of standard and custom antennas to meet user needs.

**Mechanical Specifications & Ordering Part Number**

Ordering Part #	AP822601
Dimensions (mm)	49.6 x 8.0 x 3.3
Mounting Type	SMT (P&P)
Weight (grams)	2.63
Packaging	Tape and Reel
Demo Board	P822601-01
Temperature Range	-50/+125 °C
Temperature Cycle	IEC 60068-2-14
Temperature Exposure	Mil-STD-202 Method 108
High Temperature & High Humidity	MIL-STD-202
Mechanical Shock	IEC 60068-2-27
Vibration	IEC 60068-2-6
IMDS and PPAP available	

LTE/LPWA Universal Broadband Embedded Automotive Antenna Specifications.  
 KYOCERA AVX produces a wide variety of standard and custom antennas to meet user needs.

LTE Bands covered by (AP822601)

LTE Band	Frequency Band (MHz)	Uplink (UL) (MHz)	Downlink (DL) (MHz)	Region	Covered
1	2100	1920 - 1980	2110 - 2170	Global	Yes
2	1900	1850 - 1910	1930 - 1990	NAM	
3	1800	1710 - 1785	1805 - 1880	Global	
4	1700	1710 - 1755	2110 - 2155	NAM	
5	850	824 - 849	869 - 894	NAM	
6	850	830 - 840	875 - 885	APAC	
7	2600	2500 - 2570	2620 - 2690	EMEA	
8	900	880 - 915	925 - 960	Global	
9	1800	1749.9 - 1784.9	1844.9 - 1879.9	APAC	
10	1700	1710 - 1770	2110 - 2170	NAM	
11	1500	1427.9 - 1447.9	1475.9 - 1495.9	Japan	No
12	700	699 - 716	729 - 746	NAM	Yes
13	700	777 - 787	746 - 756	NAM	
14	700	788 - 798	758 - 768	NAM	
17	700	704 - 716	734 - 746	NAM	
18	850	815 - 830	860 - 875	Japan	
19	850	830 - 845	875 - 890	Japan	
20	800	832 - 862	791 - 821	EMEA	
21	1500	1447.9 - 1462.9	1495.9 - 1510.9	Japan	No
22	3500	3410 - 3490	3510 - 3590	EMEA	Yes
23	2000	2000 - 2020	2180 - 2200	NAM	No
24	1600	1626.5 - 1660.5	1525 - 1559	NAM	No
25	1900	1850 - 1915	1930 - 1995	NAM	Yes
26	850	814 - 849	859 - 894	NAM	
27	850	807 - 824	852 - 869	NAM	
28	700	703 - 748	758 - 803	APAC,EU	
29	700	N/A	717 - 728	NAM	
30	2300	2305 - 23151	2350 - 2360	NAM	No
31	450	452.5 - 457.5	462.5 - 467.5	Global	
32	1500	N/A	1452 - 1496	EMEA	
33	1900		1900 - 1920		Yes
34	2000		2010 - 2025		
35	1850		1850 - 1910		
36	1900		1930 - 1990		
37	1900		1910 - 1930		
38	2600		2570 - 2620		
39	1900		1880 - 1920		
40	2300		2300 - 2400		
41	2500		2496 - 2690		
42	3500		3400 - 3600		
43	3700		3600 - 3800		

LTE/LPWA Universal Broadband Embedded Automotive Antenna Specifications.  
 KYOCERA AVX produces a wide variety of standard and custom antennas to meet user needs.

**Antenna Dimensions (AP822601)**

Typical antenna dimensions (mm)

Part Number	A	B	C
AP822601	49.6 ± 0.2	8.0 ± 0.2	3.3 ± 0.33

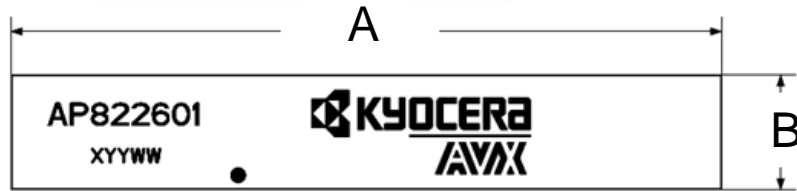
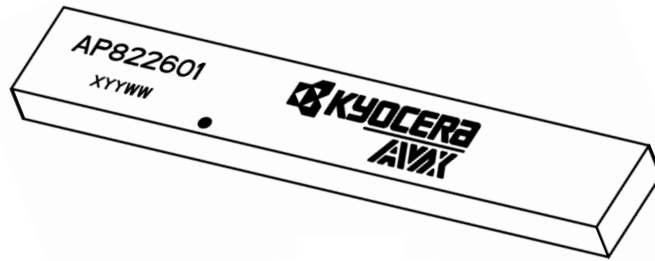

**Top View**

Pin#	Description
1	Feed
2	Ground
3	Dummy Pad
4	Low Band Tuning
5	High Band Tuning
6	Dummy Pad
7	Dummy Pad



**Front View/Height**

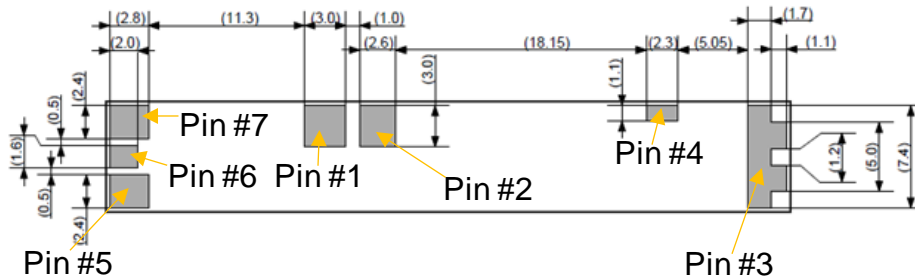

**Bottom View**

LTE/LPWA Universal Broadband Embedded Automotive Antenna Specifications.  
KYOCERA AVX produces a wide variety of standard and custom antennas to meet user needs.

### VSWR and Efficiency Plots

Typical AP822601 performance 140 x 50 mm PCB

**Low Band VSWR**

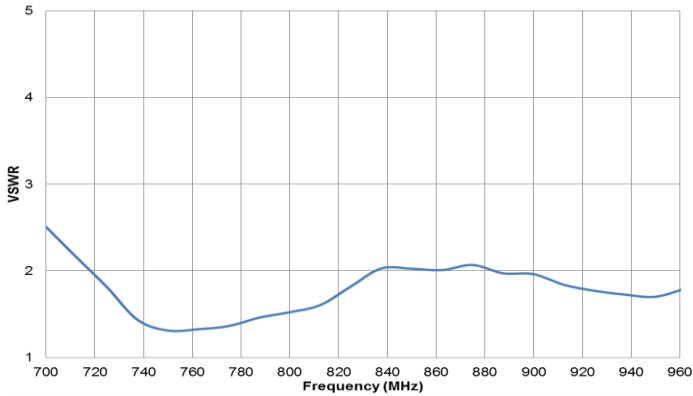

**Low Band Efficiency**

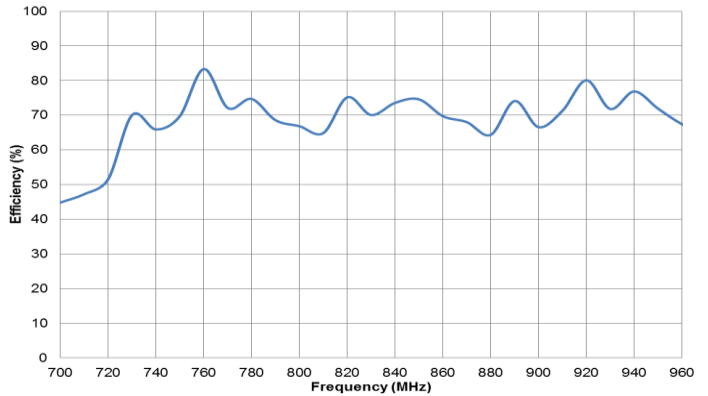

**High Band VSWR**

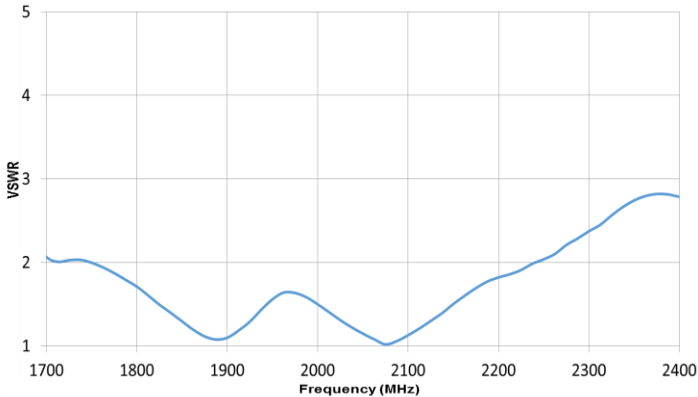

**High Band Efficiency**

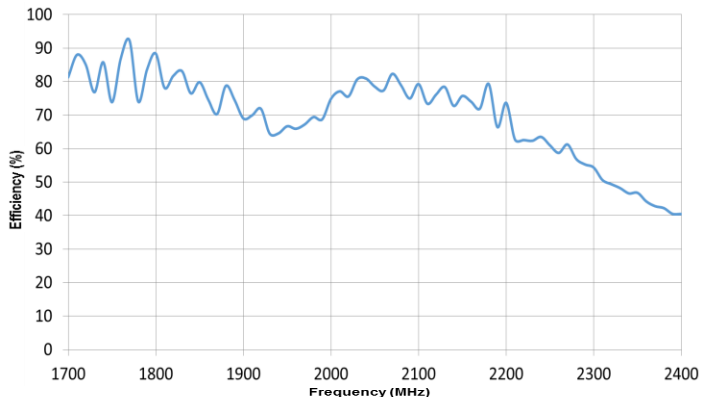

**Band 7 VSWR**

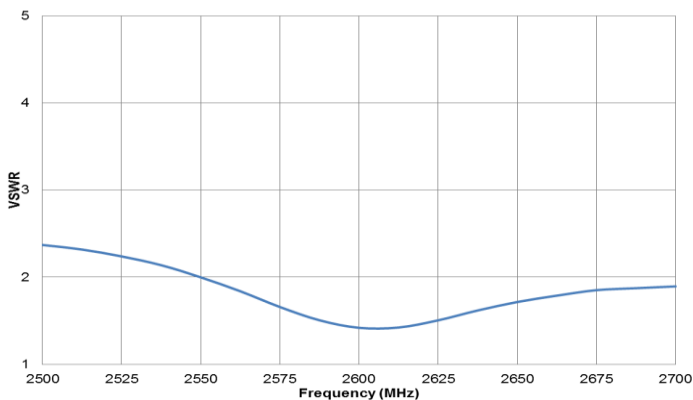

**Band 7 Efficiency**

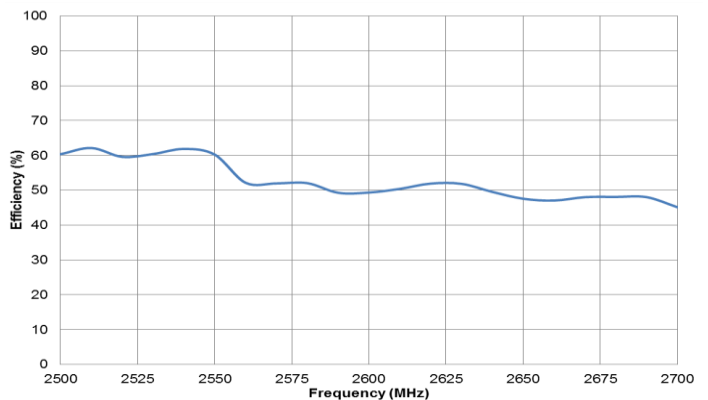

LTE/LPWA Universal Broadband Embedded Automotive Antenna Specifications.  
 KYOCERA AVX produces a wide variety of standard and custom antennas to meet user needs.

### VSWR and Efficiency Plots

Typical AP822601 performance 140 x 50 mm PCB

**Band 40 VSWR**

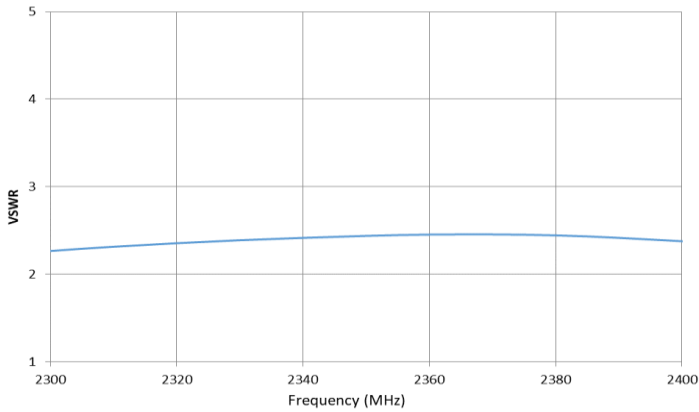

**Band 40 Efficiency**

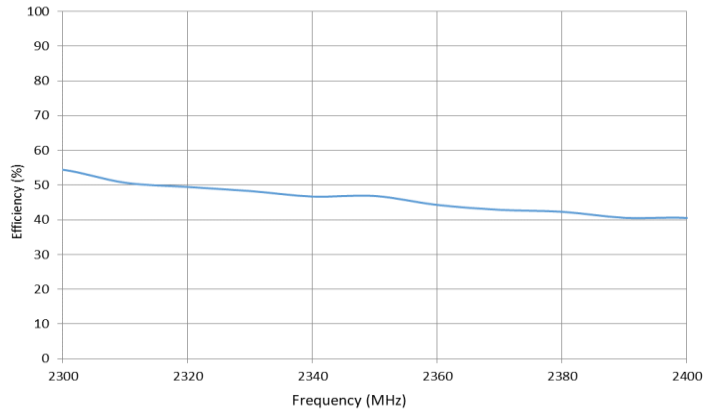

**n78 VSWR**

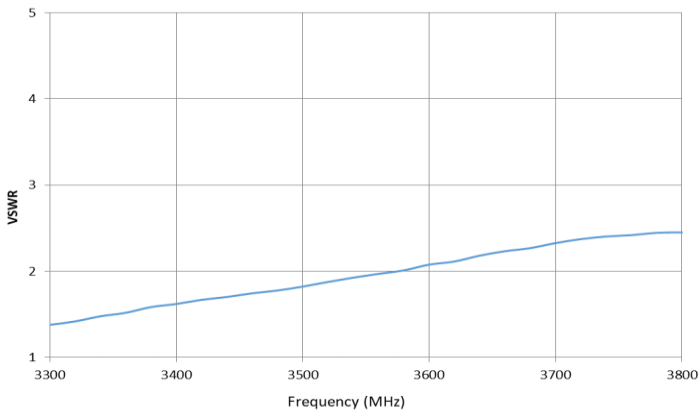

**n78 Efficiency**

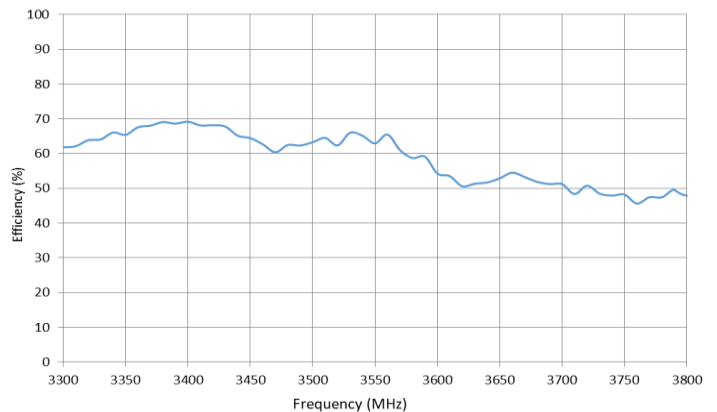

LTE/LPWA Universal Broadband Embedded Automotive Antenna Specifications.  
 KYOCERA AVX produces a wide variety of standard and custom antennas to meet user needs.

**Antenna Radiation Patterns – Low / High Band (LTE)**

Typical AP822601 performance 140 x 50 mm PCB

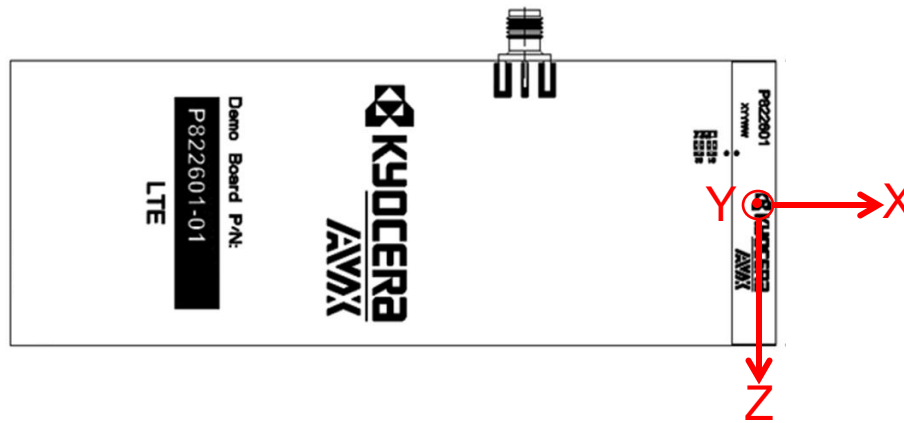

Low Band measured at 700, 750, 850, 900 MHz

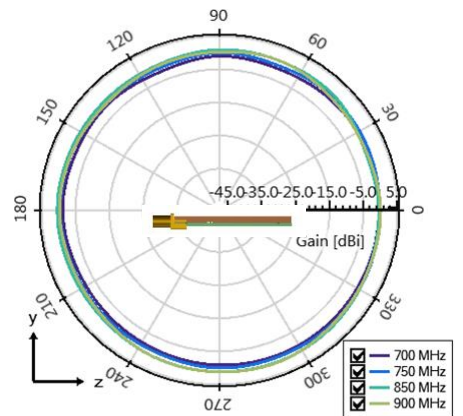
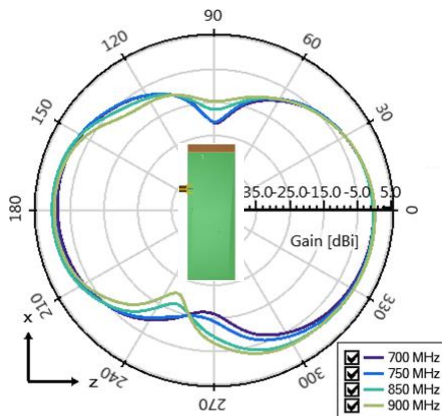
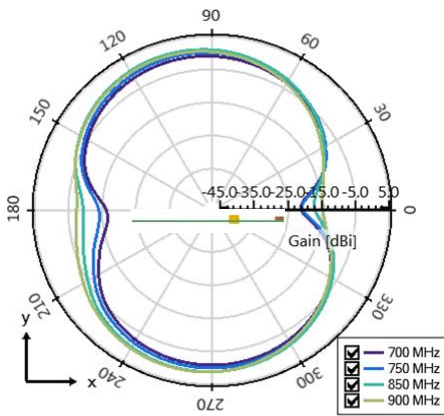

High Band measured at 1800, 1900, 2100 MHz

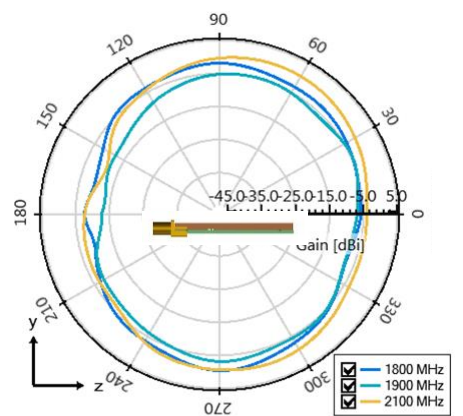
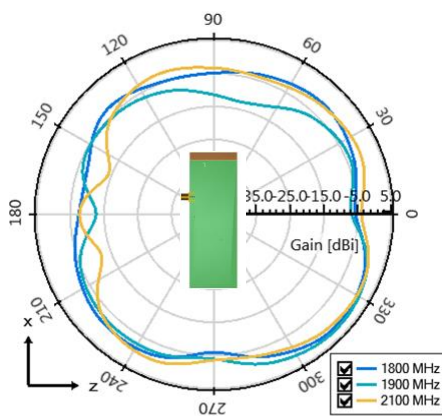
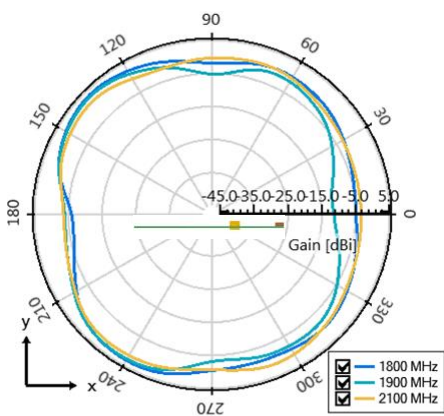

LTE/LPWA Universal Broadband Embedded Automotive Antenna Specifications.  
 KYOCERA AVX produces a wide variety of standard and custom antennas to meet user needs.

### Antenna Radiation Patterns – Band 40, Band 7

Typical AP822601 performance 140 x 50 mm PCB

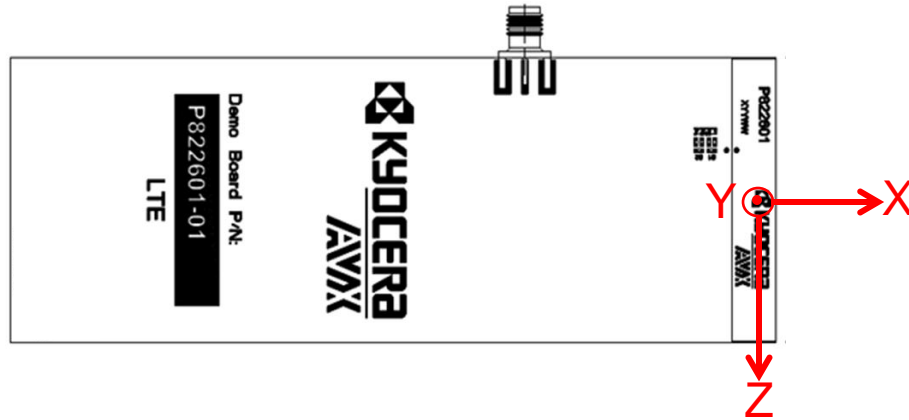

Band 40 measured at 2350 MHz

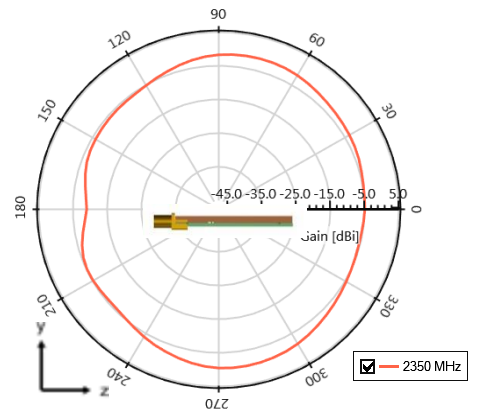
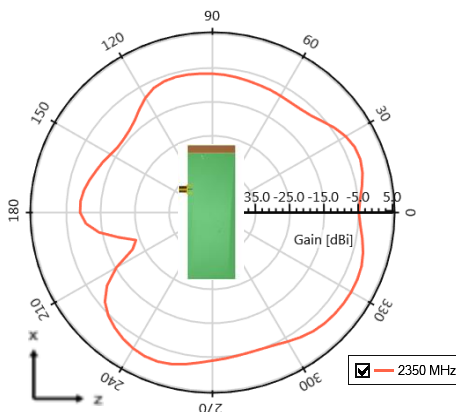
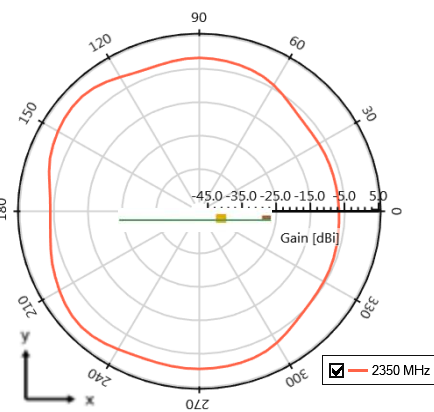

Band 7 measured at 2600 MHz

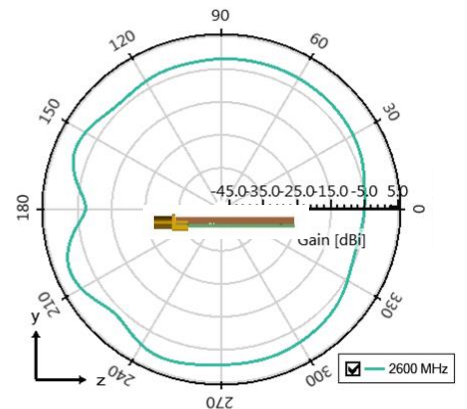
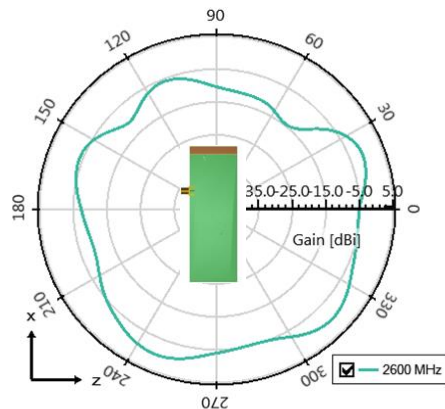
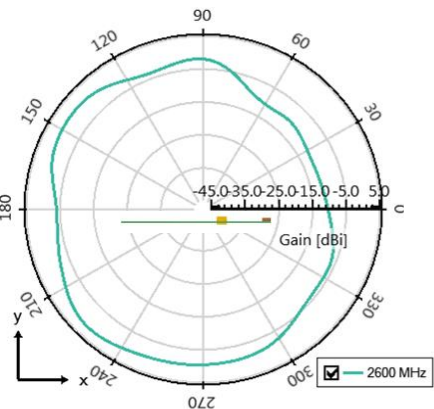



LTE/LPWA Universal Broadband Embedded Automotive Antenna Specifications.  
 KYOCERA AVX produces a wide variety of standard and custom antennas to meet user needs.

### Antenna Radiation Patterns – n78

Typical AP822601 performance 140 x 50 mm PCB

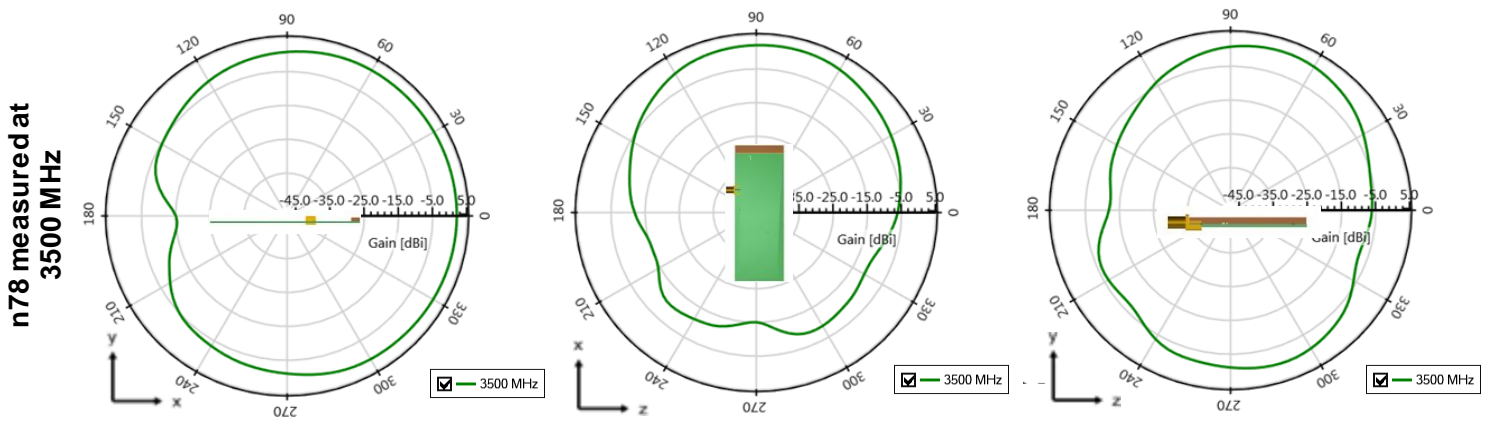
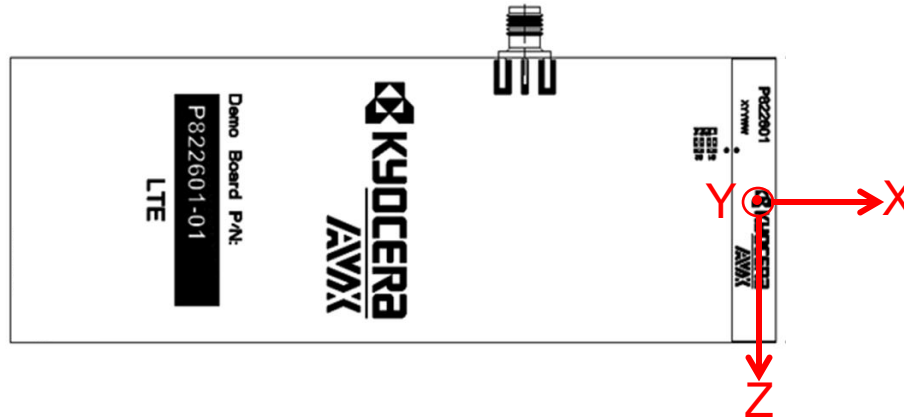

LTE/LPWA Universal Broadband Embedded Automotive Antenna Specifications.  
 KYOCERA AVX produces a wide variety of standard and custom antennas to meet user needs.

**Antenna Layout (AP822601)**  
 Typical layout dimensions (mm)

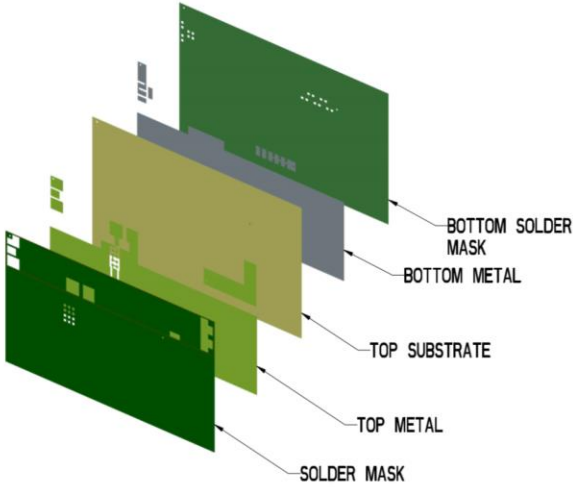

- Additional VIAS: Diam. 0.2mm to be placed around antenna, (no vias on transmission lines).
- Via holes must be covered by solder mask

**Pin Descriptions**

Pin#	Description
1	Feed
2	Ground
3	Dummy Pad
4	Low Band Tuning
5	High Band Tuning
6	Dummy Pad
7	Dummy Pad

\* uses the same layout but mirrored.

Default Pi Matching Network values with instructions can be found under Antenna Matching Network.

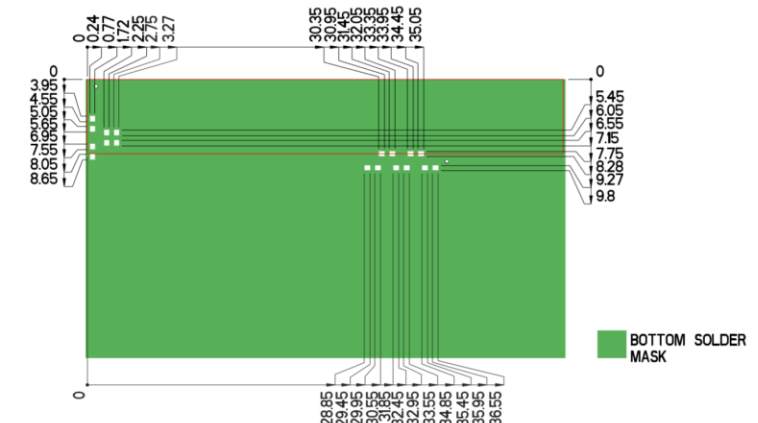
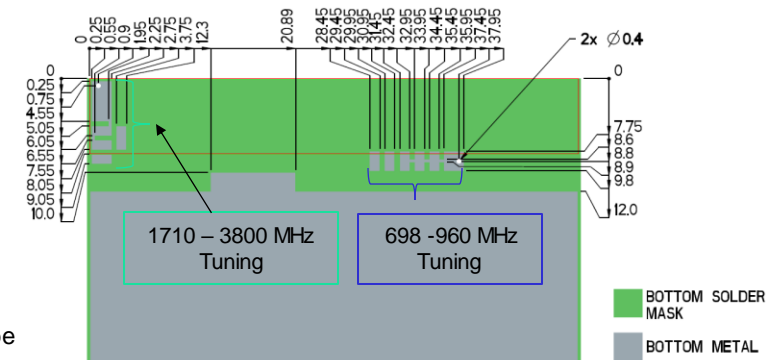
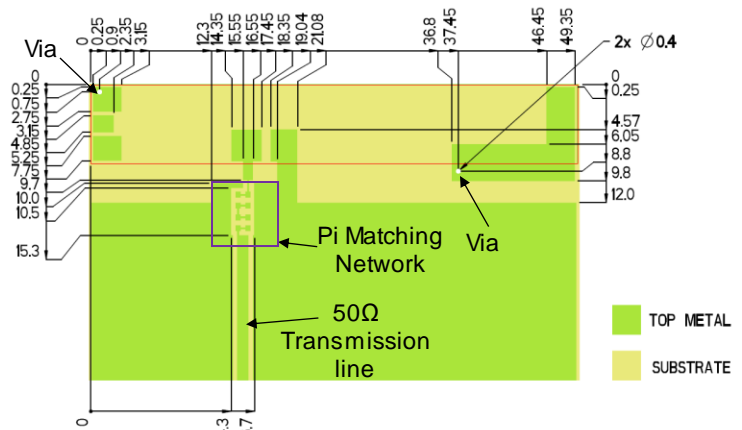
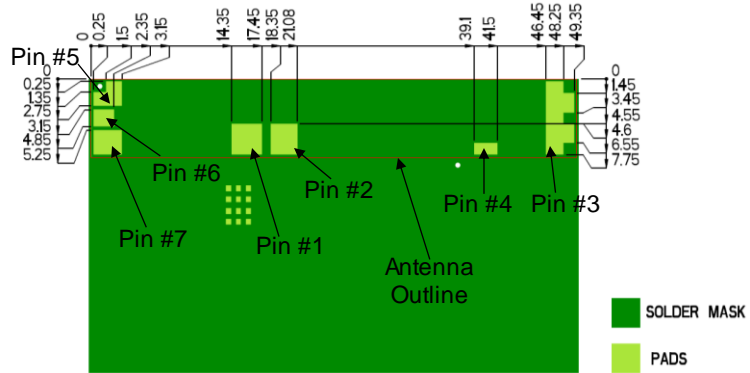

LTE/LPWA Universal Broadband Embedded Automotive Antenna Specifications.  
KYOCERA AVX produces a wide variety of standard and custom antennas to meet user needs.

### Antenna Matching Structure (AP822601)

Typical matching values on 140 x 50 mm PCB

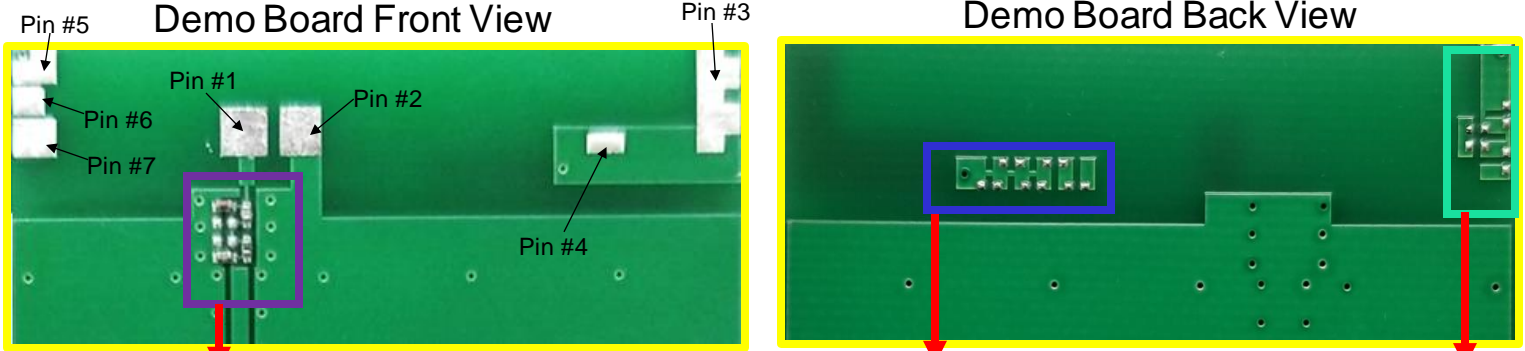

**Antenna Matching**

**698-960 MHz Tuning**

**1710-3800 MHz Tuning**

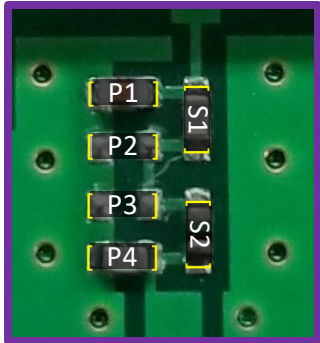

(Antenna Matching): pads are directly inline with the antenna feed trace.

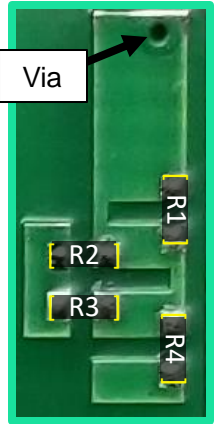
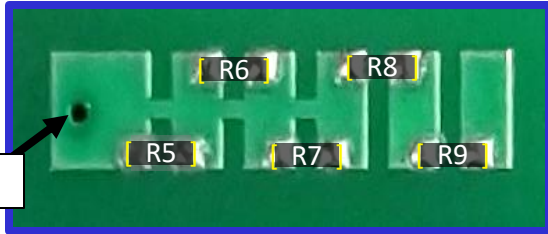

#### Pin Descriptions

Pin#	Description
1	Feed
2	Ground
3	Dummy Pad
4	Low Band Tuning
5	High Band Tuning
6	Dummy Pad
7	Dummy Pad

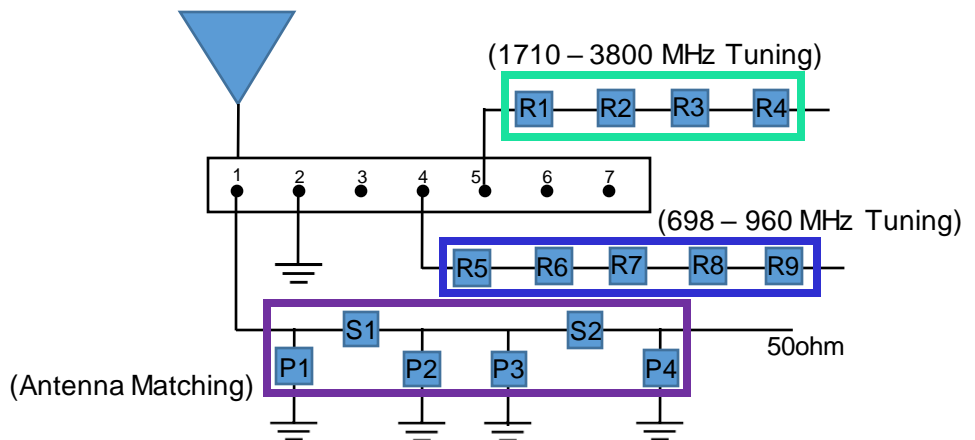

\* uses same matching values

	P1	S1	P2	P3	S2	P4	R1-R4	R5-R9
<b>Default Matching</b>	24nH	2.4pF	DNI	DNI	1.0nH	0.3pF	DNI	DNI
<b>Tolerance</b>	± 20%	± 0.25pF	N/A	N/A	± 0.3nH	± 0.1pF	N/A	N/A

LTE/LPWA Universal Broadband Embedded Automotive Antenna Specifications.  
 KYOCERA AVX produces a wide variety of standard and custom antennas to meet user needs.

### Antenna Matching Structure (AP822601)

Typical matching values on 140 x 50 mm PCB

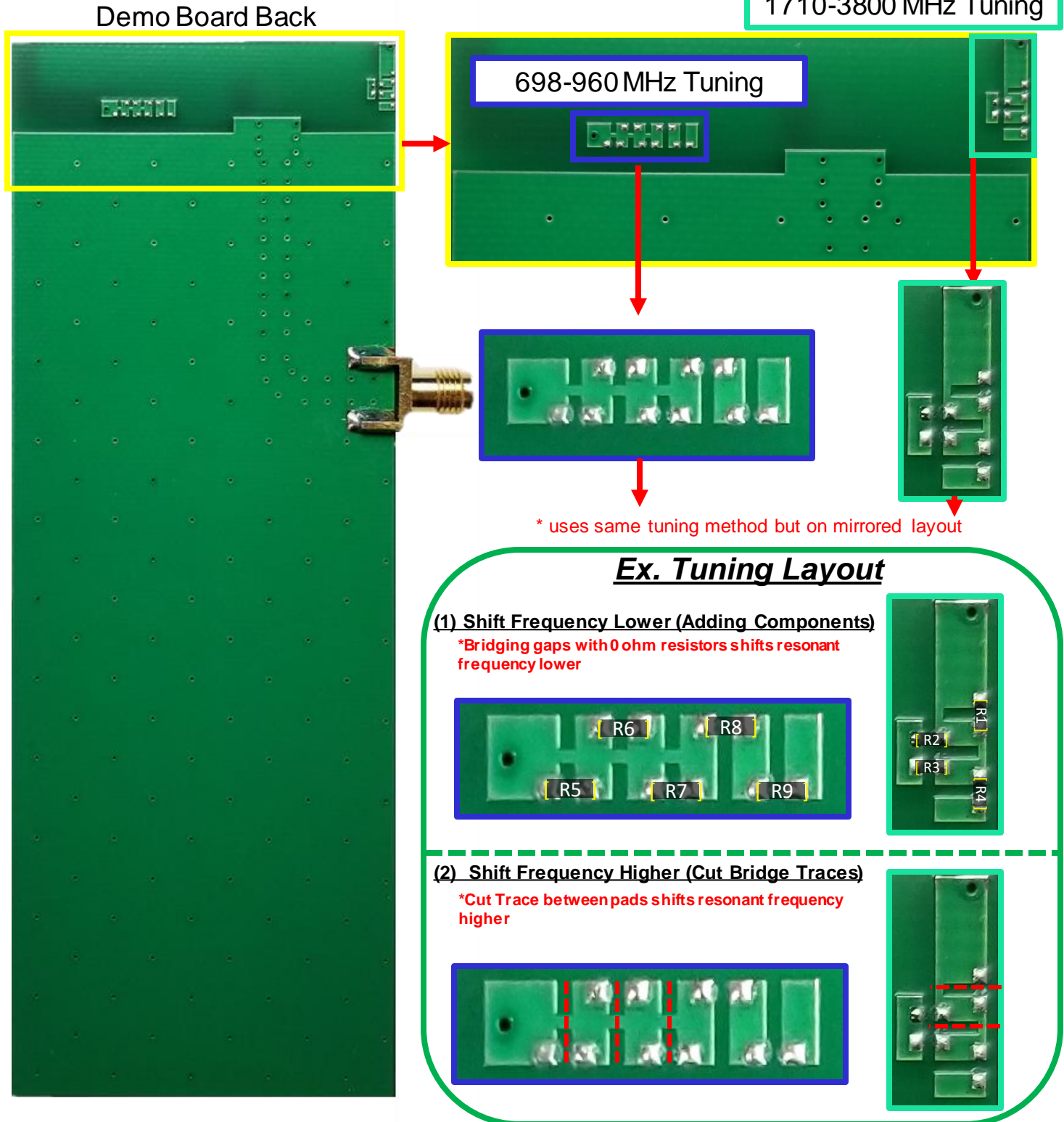

LTE/LPWA Universal Broadband Embedded Automotive Antenna Specifications.  
 KYOCERA AVX produces a wide variety of standard and custom antennas to meet user needs.

**Antenna Demo Board (P822601-01)**

Demo Board Front/Back View

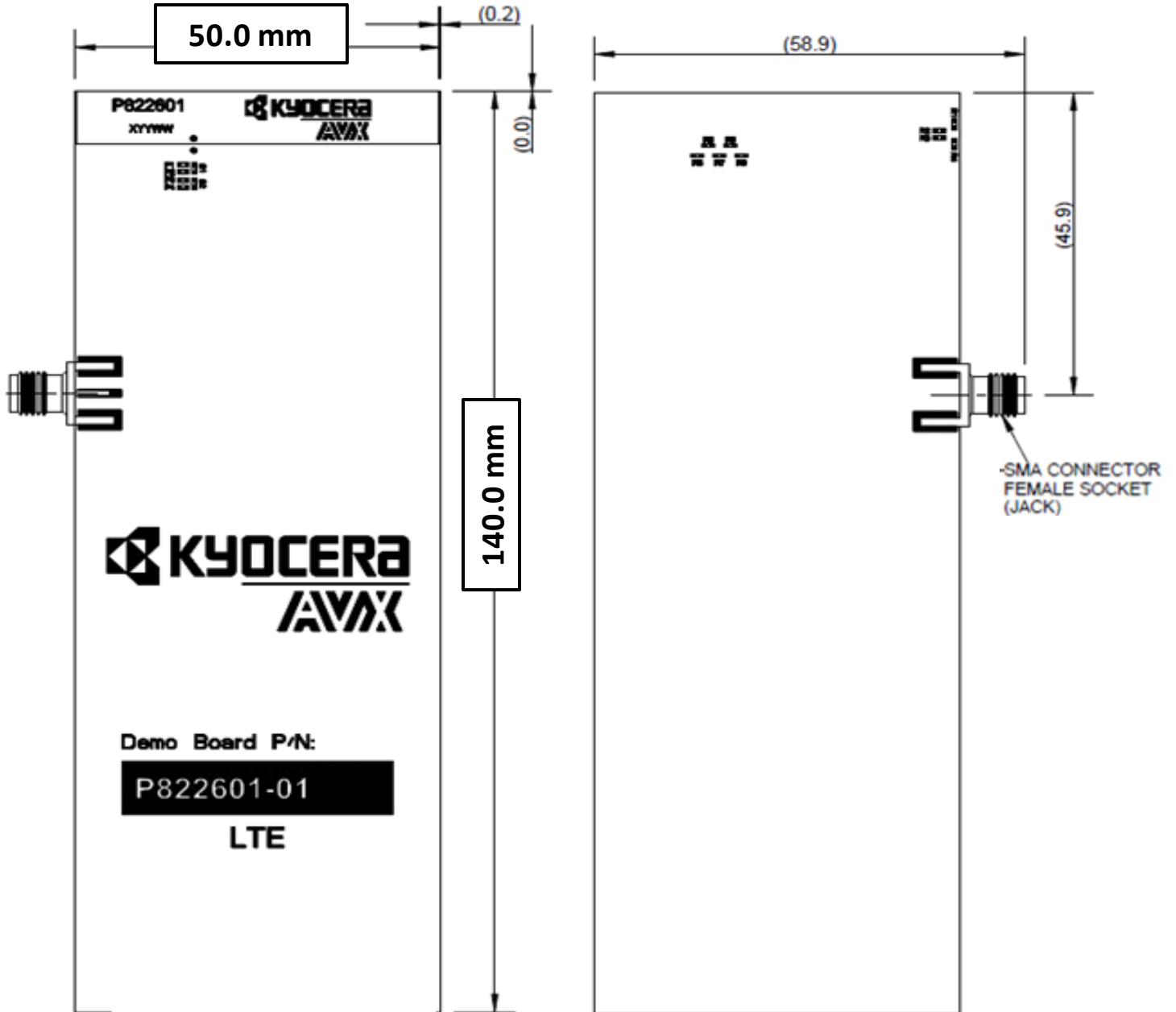

LTE/LPWA Universal Broadband Embedded Automotive Antenna Specifications.  
 KYOCERA AVX produces a wide variety of standard and custom antennas to meet user needs.

### Recommended Reflow Soldering Profile

The recommended method for soldering the antenna to the board is forced convection reflow soldering. The following suggestions provide information on how to optimize the reflow process for the FR4 antenna:

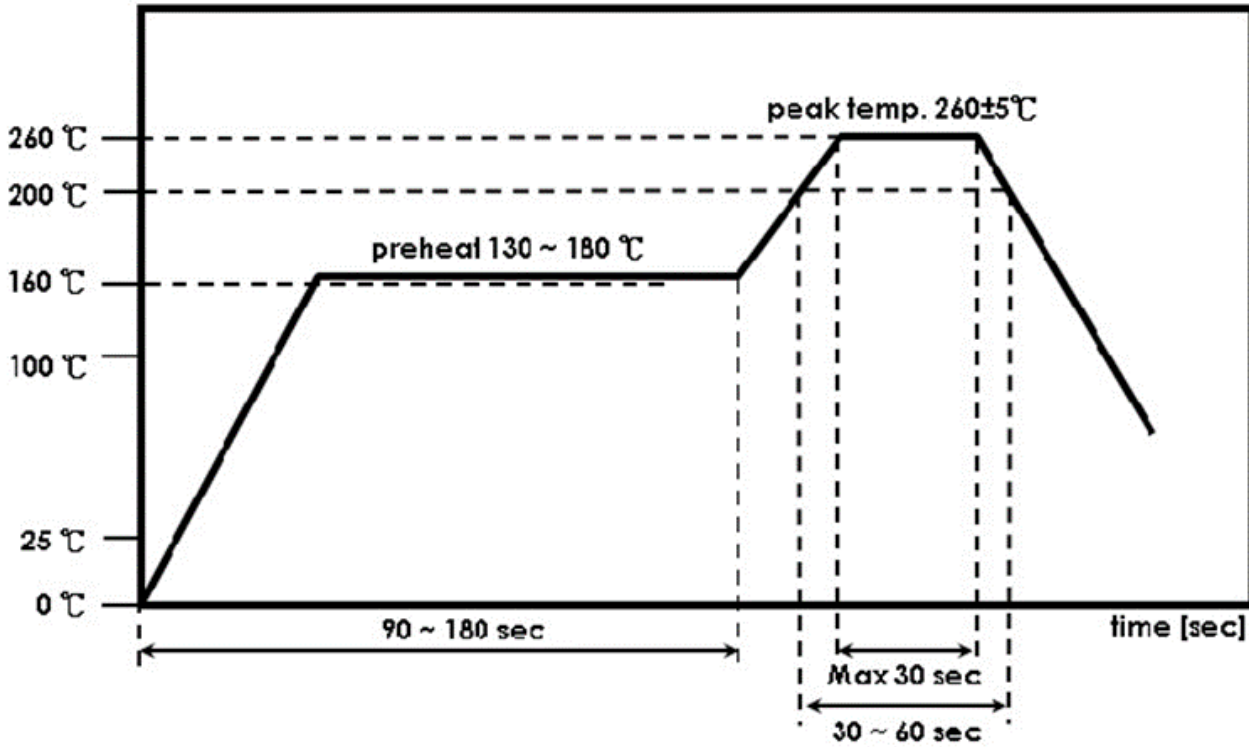

\*Adjust the reflow duration to create good solder joints without raising the antenna temperature beyond the allowed maximum of 260° C.