

# Mini50 Unsealed Connector System >

Delivering 50% space savings over traditional USCAR 0.64mm connectors with smaller terminals to fit more signals into vehicle interiors, the Mini50 Unsealed Connector System is approved as the industry's only USCAR 050 interface.

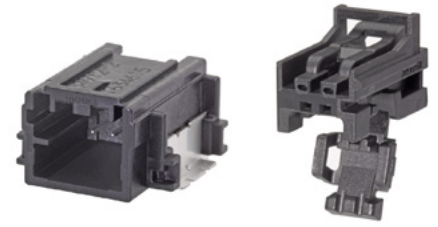

Mini50 2-Circuit SMT Header and Receptacle

## ADVANTAGES AND FEATURES

Delivers the only two-circuit connector with a 0.50mm terminal interface in the industry; tested to full USCAR specifications; enhances design flexibility

Addition of 2 circuit-size SMT headers and receptacles

Industry's only interface that meets USCAR 050 specifications; offers from 4 to 24 circuits; larger circuit versions also comply with USCAR specifications

Designed and tested to USCAR 050 specifications

Minimizes PCB footprint for design flexibility and space saving

50% smaller than USCAR 0.64mm unsealed interfaces

Secures terminal inside the housing; one-piece design for applied cost savings

Independent secondary lock (ISL) terminal-retention feature

Provides wire-routing and module-design flexibility for both vertical and right-angle connectors. Retains the header to the PCB during the soldering process

Orientation features molded into the header

Simplifies header placement on the PCB and retains the header to the PCB during soldering operation(s). Protects adhesive joints during connector mating and unmating

Board alignment and retention features

Withstands infrared (IR) and wave lead-free solder processing per ES-40000-5013 Molex specification, up to a maximum temperature of +260°C

High-temperature thermoplastic housings

Offers better conductivity and corrosion resistance and lower insertion force than standard Tin plating

Gold-plating option

Enables limited customization and enforces like-to-like mating via three discrete mechanical, visual and colored polarizations

Three polarization options

Offers harness manufacturers the ability to reduce wire gauge sizes while maintaining retention strength

CTX50 terminal wire grip design

Helps prevent accidental un-mating, an optional mating assurance feedback device

Connector position assurance (CPA) feature available

### Female Receptacle

USCAR 1-by-4

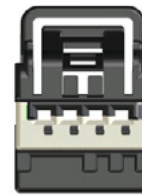

Mini50 1-by-4



Approximate 51% reduction in frontal area for 4-circuit receptacle

### Male Right-Angle Header

USCAR 1-by-4

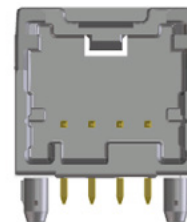

Mini50 1-by-4



Approximate 50% reduction in frontal area for 4-circuit right-angle header

# Mini50 Unsealed Connector System >

## MINI50 HARNESS ASSEMBLY COMPLEXITY REDUCTION

The independent secondary lock (ISL) is molded as part of the housing, reducing the number of components and cost.

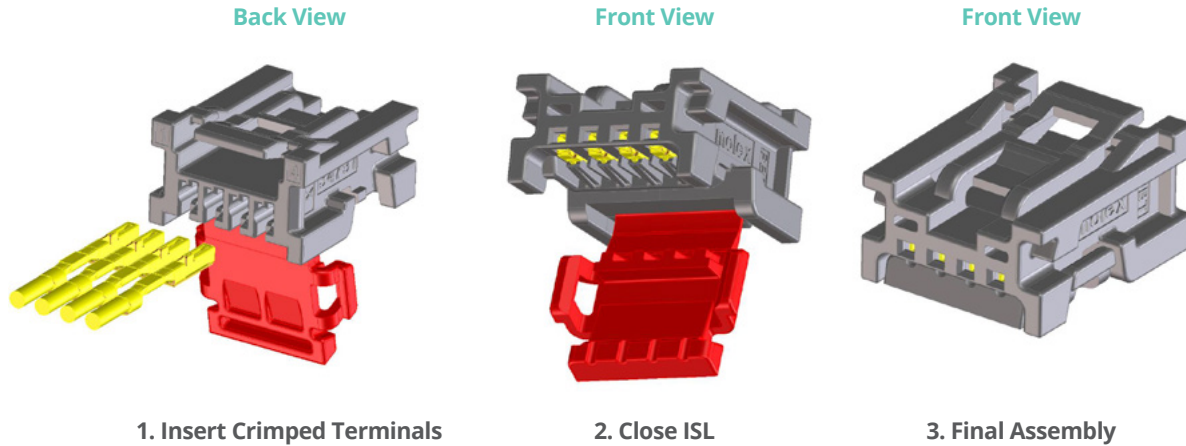

## PRODUCT IMPROVEMENTS - OPTIONAL CPA ADDITION

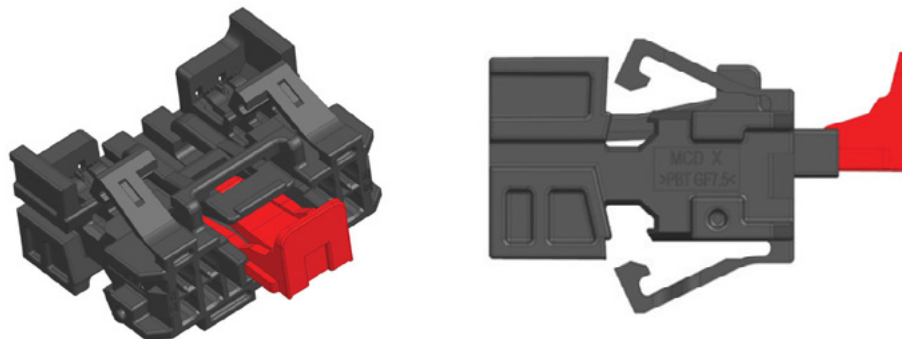

This is available on all sizes from 4 to 24 circuits

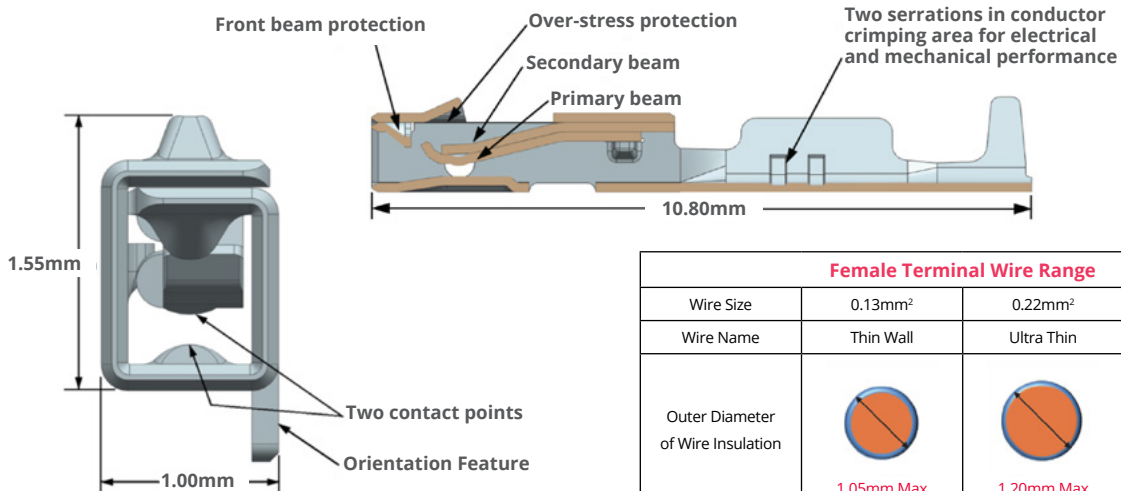

## CTX50 FEMALE RECEPTACLE TERMINAL

All dimensions shown in millimeters



Female Terminal Wire Range			
Wire Size	0.13mm <sup>2</sup>	0.22mm <sup>2</sup>	0.35mm <sup>2</sup>
Wire Name	Thin Wall	Ultra Thin	Thin Wall
Outer Diameter of Wire Insulation	 1.05mm Max	 1.20mm Max	 1.40mm Max
Recommended Grip Size	Grip S	Grip M	Grip L

# Mini50 Unsealed Connector System

## Mini50 Receptacles



4-circuit  
Polarization A  
Housing

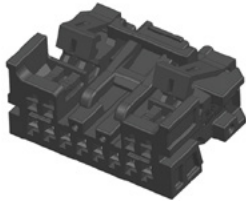

12-circuit  
Polarization A  
Housing

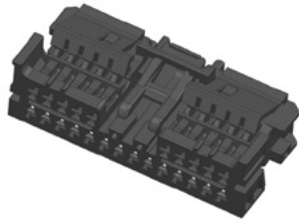

20-circuit  
Polarization A  
Housing

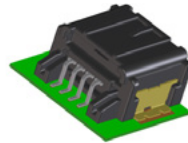

4-circuit  
Polarization A  
SMT Header

## Mini50 Headers

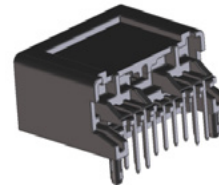

12-circuit  
Polarization A  
R/A Header



20-circuit  
Polarization A  
Vertical Header

## USCAR 050 SPECIFICATIONS

### Reference Information

#### Packaging:

Housings – Bulk pack

Terminals – Reel and loose piece

#### Mates With:

Receptacles Series: 34791, 34824, 34959, 206523, 207584, 213356

Vertical Headers Series: 34792, 34824, 34825

Right-Angle Header Series:

34793, 34912, 34826, 34897

#### Use With Terminals:

Female Series 560023

Designed in: Millimeters

### Physical

Header Housings: High-Temperature Thermoplastic

Receptacle Housings: High Temperature Thermoplastic

Contact: Copper (Cu) Alloy

#### Plating:

Contact Area — Tin (Sn)

Underplating — Nickel (Ni)

Wire Gauge: 0.13 to 0.35mm<sup>2</sup> (22 to 26 AWG)

Insulation Diameter: 0.89 to 1.40mm  
(0.035 to 0.055")

Operating Temperature: -40 to +105°C

### Electrical

Voltage (max.): 14V

Current (max.): 4.0A

Contact Resistance (max.): 20 Milliohms

Dielectric Withstanding Voltage (min.): 1500V AC

Isolation Resistance (min.): 100 Megohms

### Electrical / Mechanical

Over-Current Loading: No Degradation

Durability (max.): 20 milliohms

Tin (Sn) Plating – 10 Mating Cycles

Gold (Au) Plating – Over 10 Mating cycles

High-Temperature Exposure, 1008 hours

(USCAR-2, GMW3191):

Post test resistance (max.) –

20 Milliohms @ 500V DC

Isolation resistance (max.) – 100 Megohms

Connector Retention Force (min.) = 60N

Temp / Humidity Cycling, 240 hours

(USCAR-2, GMW3191):

Post test resistance (max.) –

20 Milliohms @ 500V DC

Isolation resistance (max.) – 100 Megohms

Connector Retention Force (max) = 60N

Terminal Retention (min.) = 30N

Thermal Shock; class 2, 300& 600 cycles

(USCAR-2):

Post test resistance (max.) –

20 Milliohms @ 500V DC

Isolation resistance (max.) – 100 Megohms

Connector Retention Force (max.) = 60N

Terminal Retention (min.) = 30N

Chemical Resistance: (RSA 36-05-019) :

Post test resistance (max.) –

20 Milliohms @ 500V DC

Isolation resistance (max.) –

100 Megohms Connector

Terminal Retention (min.) = 30N

Current Capability: (USCAR-2, Fiat 7-Z8260):

Temperature rise over ambient < 55C

Post test resistance (max.) –

20 Milliohms @ 500V DC

Terminal Retention (min.) = 30N

Terminal – Connector Insertion Force

(USCAR-2, GMW3191):

Insertion Force (max.) = 5N

Primary Retention Force (min.) = 10N

Secondary Retention Force (min.) = 50N

### Electrical / Mechanical

Mating Force (USCAR-2) (max.): 22N

Unmating Force (USCAR-2) (max.): 22N

Connector Drop Test:

(USCAR-2, RSA 36-05-019):

Post test visual inspection

Connector Pry Resistance: (USCAR-2):

Post test resistance (max.) –

20 Milliohms @ 500V DC

Repetitive Mating / Unmating: (USCAR-2):

Post test resistance (max.) –

30 Milliohms @ 500V DC

Polarization Feature Effectiveness (USCAR-2):

min = 3 times avg. mate force

Header Pin Retention (min.): 15N

Solderability Requirements: (SMES-152) :

Dip Coat Method– min 95% coverage

Connector Heat Resistance: (ES-40000-5013) :

Lead-free IR reflow processing =

3 cycles, max temperature +260°C

Random Vibration with Thermal Cycling/ Mechanical

Shock (Not Coupled to Engine):

(USCAR-2, GMW3191, RSA 36-05-019)

Random vibration with Thermal Cycling:

Post test resistance (max.) –

20 Milliohms @ 500V DC

Connector Retention Force (min.) = 60N

Corrosion Resistance:

(USCAR-2, GMW3191, RSA 36-05-019) :

Post test resistance (max.) –

20 Milliohms @ 500V DC

Isolation resistance (max.) –

100 Megohms Connector

Connector Retention Force (min.) = 60N

Terminal Retention (min.) = 30N

# Mini50 Unsealed Connector System >

## APPLICATIONS

### Automotive and Commercial Vehicle

Headliners  
 Clusters and navigation systems  
 Radios  
 Cameras and sensors  
 HVAC systems  
 Switches  
 Lighting equipment  
 Mirrors  
 Zonal controllers  
 Battery management systems



Mirrors/Cameras

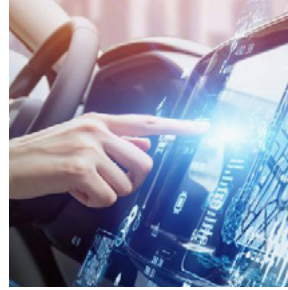

Panels/Navigation Systems



HVAC

## ORDERING INFORMATION

### Receptacles

Series No.	Component	Row	Circuit Sizes
<u>34791</u>	Receptacles	Single	2, 4 and 8
<u>34824, 206523, 207584</u>		Dual	12, 16, 20 and 24
<u>34959, 213356</u>		Three	34 Hybrid and 38

### CTX50 Terminals

Series No.	Plating	Wire Gauge (mm <sup>2</sup> )	Wound Direction / Payoff Direction
<u>560023</u>	Tin	0.08 to 0.13, 0.22, 0.35	D=Left; B=Right
<u>560023-05xx</u>	Gold	0.13 to 0.35	D=Left; B=Right

Note: Reference PS-34791-000 for all validated wire types.

# Mini50 Unsealed Connector System >

## ORDERING INFORMATION

### Payoff Direction

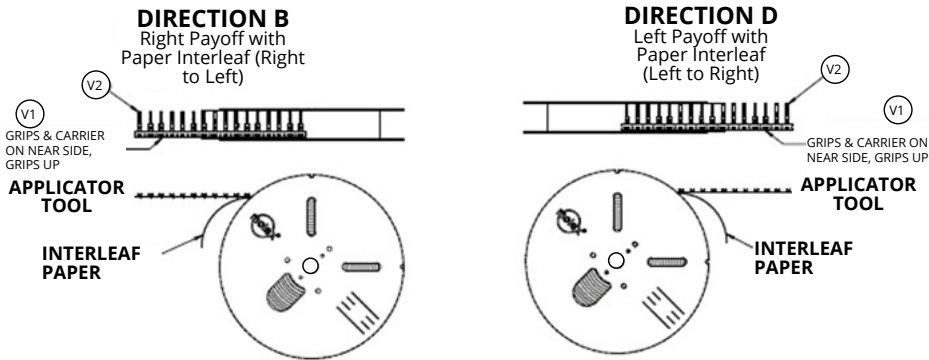

### Headers

Series No.	Plating	Rows	Orientation	Termination Style	Circuit Sizes
<a href="#">34792</a>	Tin	Single	Vertical	Through Hole	4 and 8
<a href="#">34793</a>			Right Angle		
<a href="#">34912</a>		Dual	Vertical	SMT	2, 4 and 8
<a href="#">34825</a>			Right Angle		
<a href="#">34826</a>		Three	Vertical	Through Hole	12, 16, 20 and 24
<a href="#">34897</a>			Right Angle		
<a href="#">34958</a>		SMT	Vertical	Through Hole	34 Hybrid and 38
<a href="#">34961</a>			Right Angle		
<a href="#">34960</a>		Two-Bay Stacked	Through Hole	68 (Hybrid-Hybrid), 72 (Hybrid-Three Row) and 76 (Three Row-Three Row)	
<a href="#">34912-60xx</a>		Gold	Single	Right Angle	SMT
<a href="#">34897-6xxx</a>	Gold	Dual	Right Angle	SMT	12, 16, 20 and 24