

Quick start guide

KIT_DRIVER_1EDN7550B

October 2018



Included in this kit

Evaluation kit
KIT_DRIVER_1EDN7550B

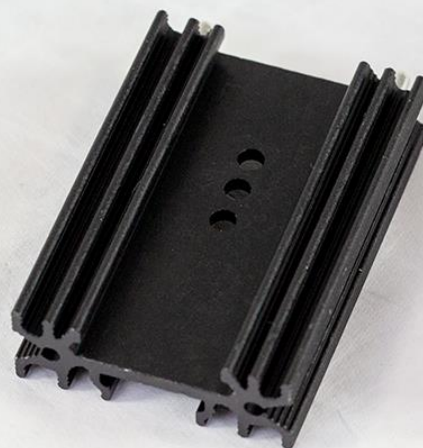

Heatsink for
TO-220 MOSFET

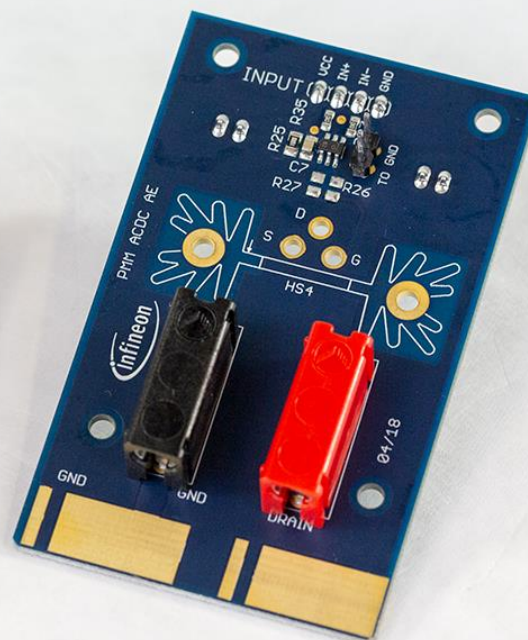

Board schematic



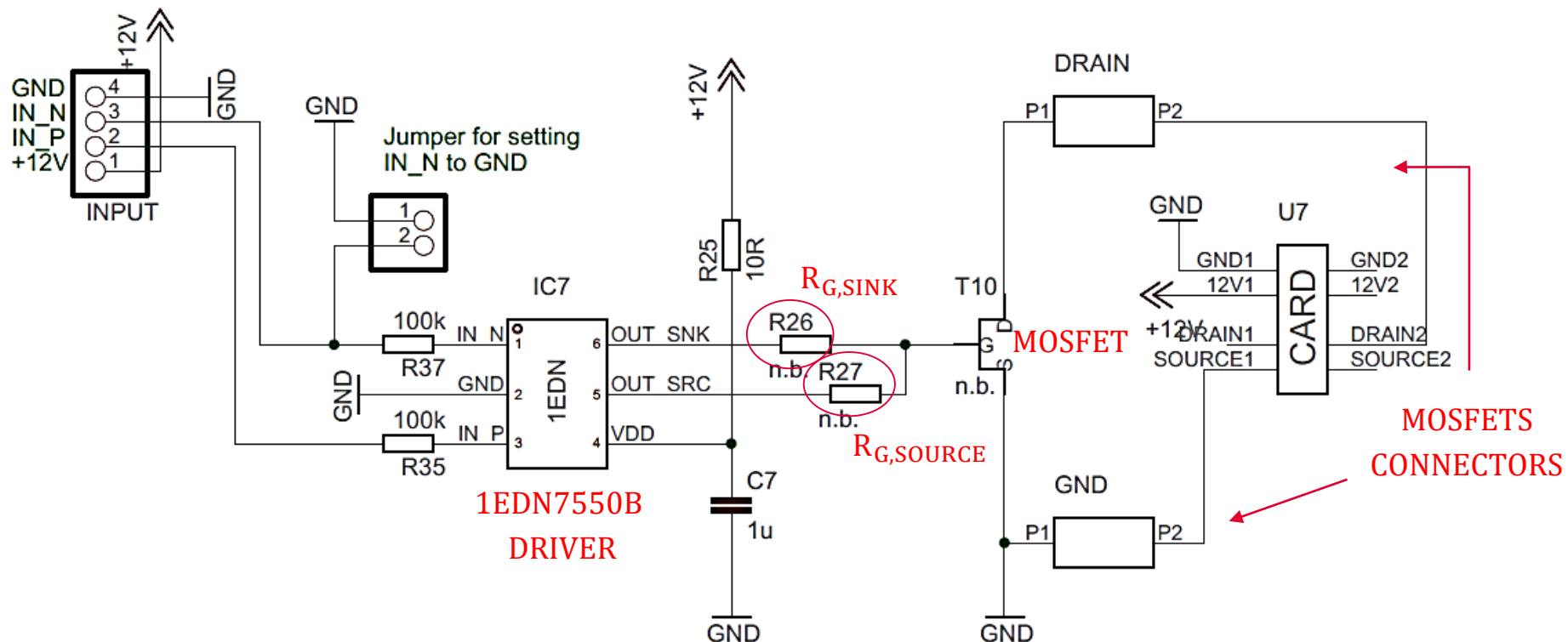

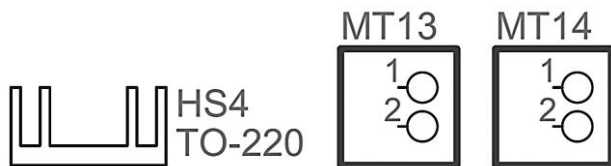

DRIVER INPUT CONNECTORS



HEATSINK

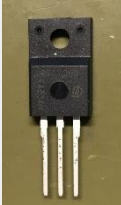

Components to add – BOM suggestion

Distance bolts	Screws for distance bolts	Screw and washer for MOSFET mounting to heatsink	TO-220 sockets
			
TO-220 MOSFET	Source resistor (R27) Sink resistor (R26)		
			

Component	Quantity	Designator	Comment	Voltage	Footprint	Type	Part number/ supplies
Resistors	2	R26,R27			RES805R	SMD ceramic resistor	
TO-220 sockets	1	T10	TO-220 socket		TO-220	Receptacle Connector 0.034" ~ 0.041" (0.86 mm ~ 1.04 mm)	5050865-5 Digi-key

Step 1: Distance bolts mounting

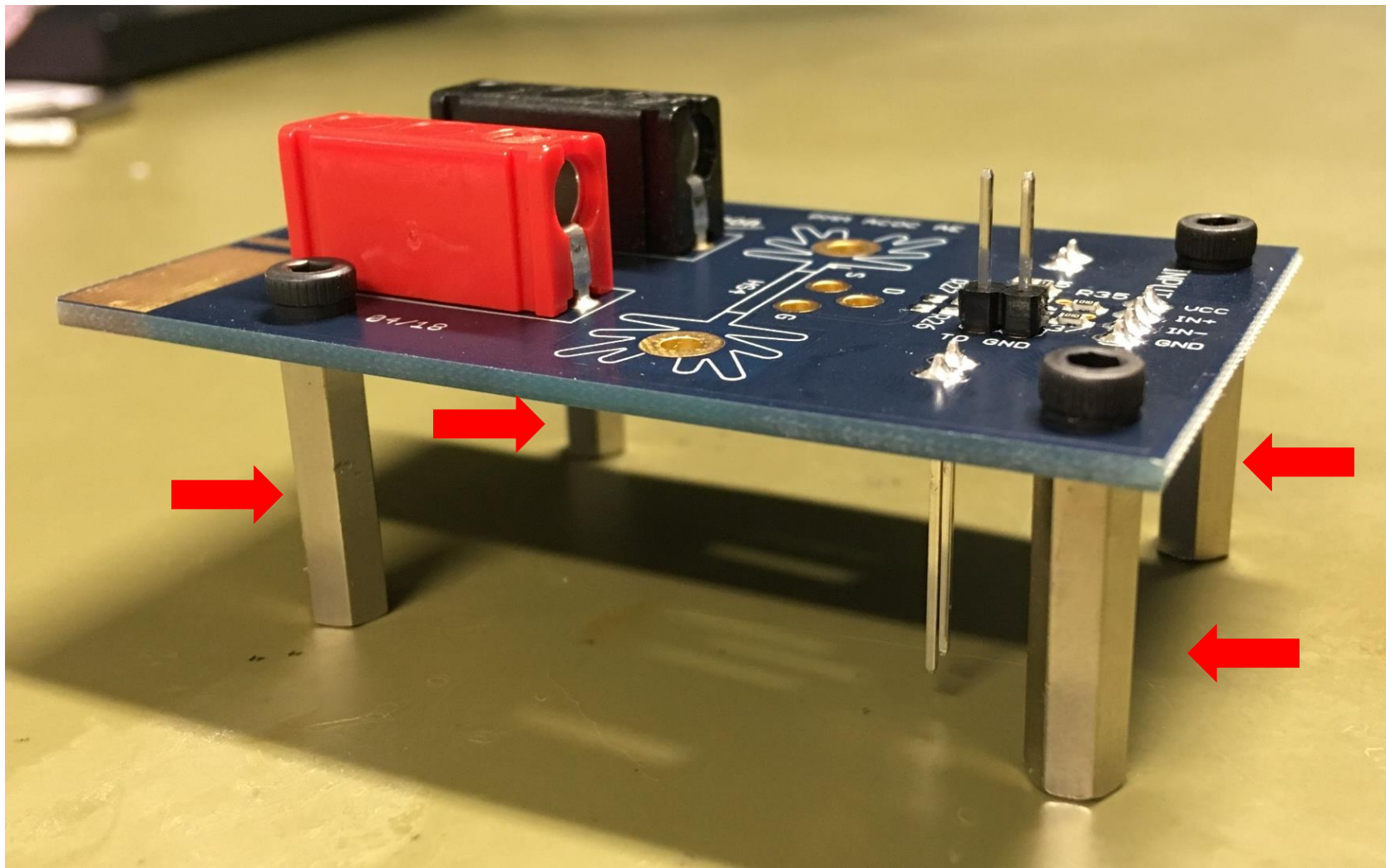

Step 2: Source resistor soldering

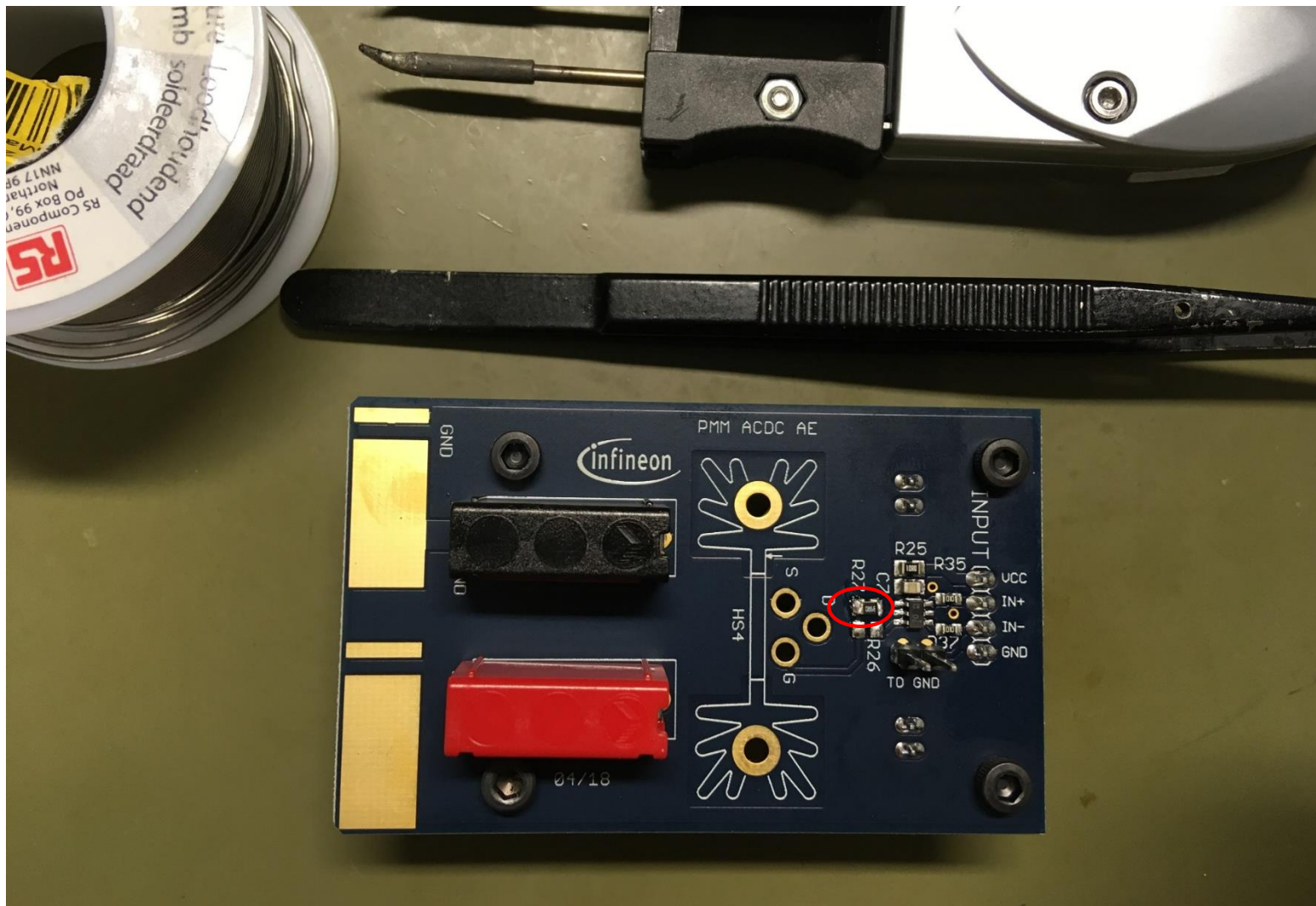

Step 3: Sink resistor soldering

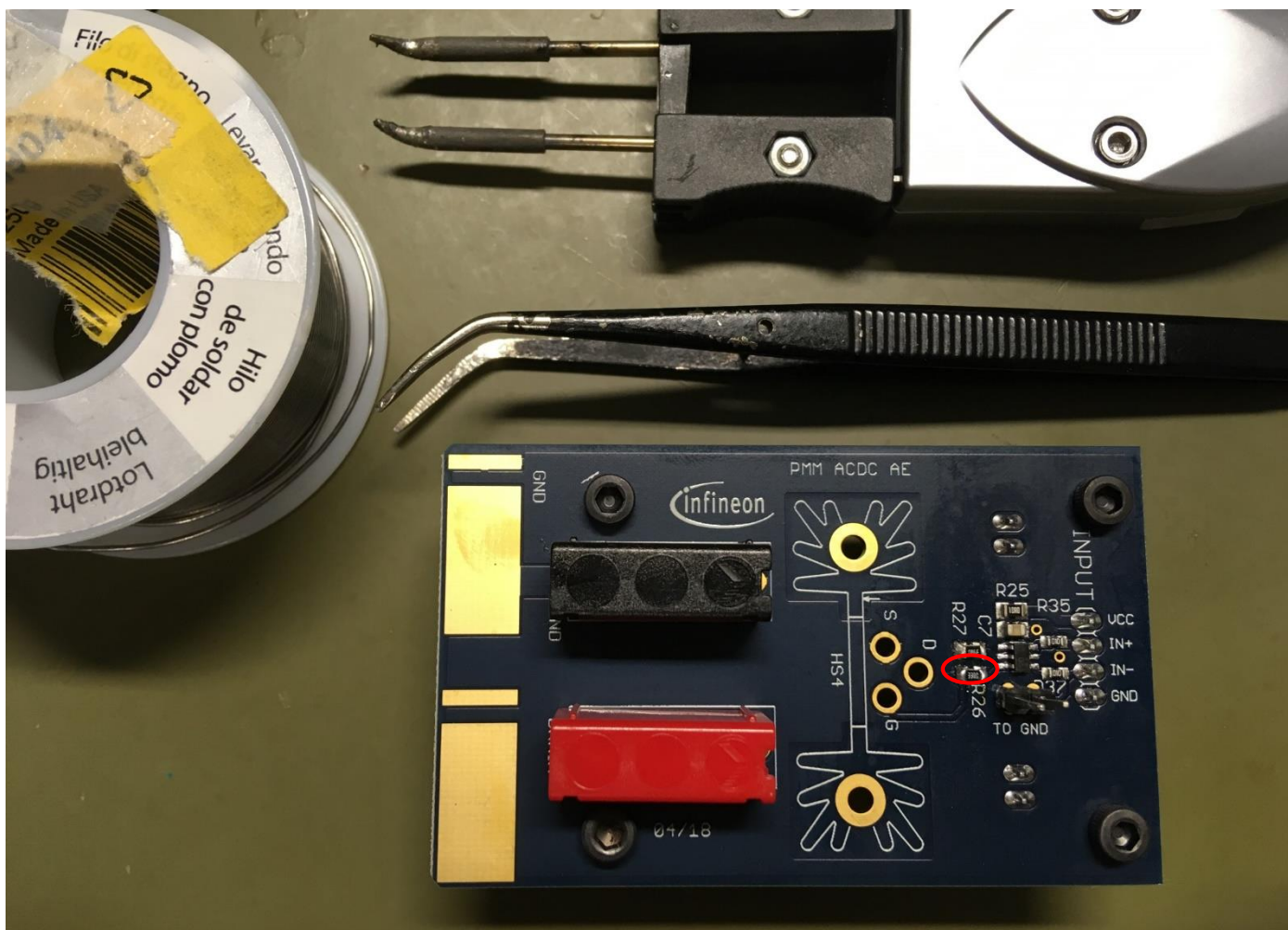

Step 4: TO-220 sockets soldering

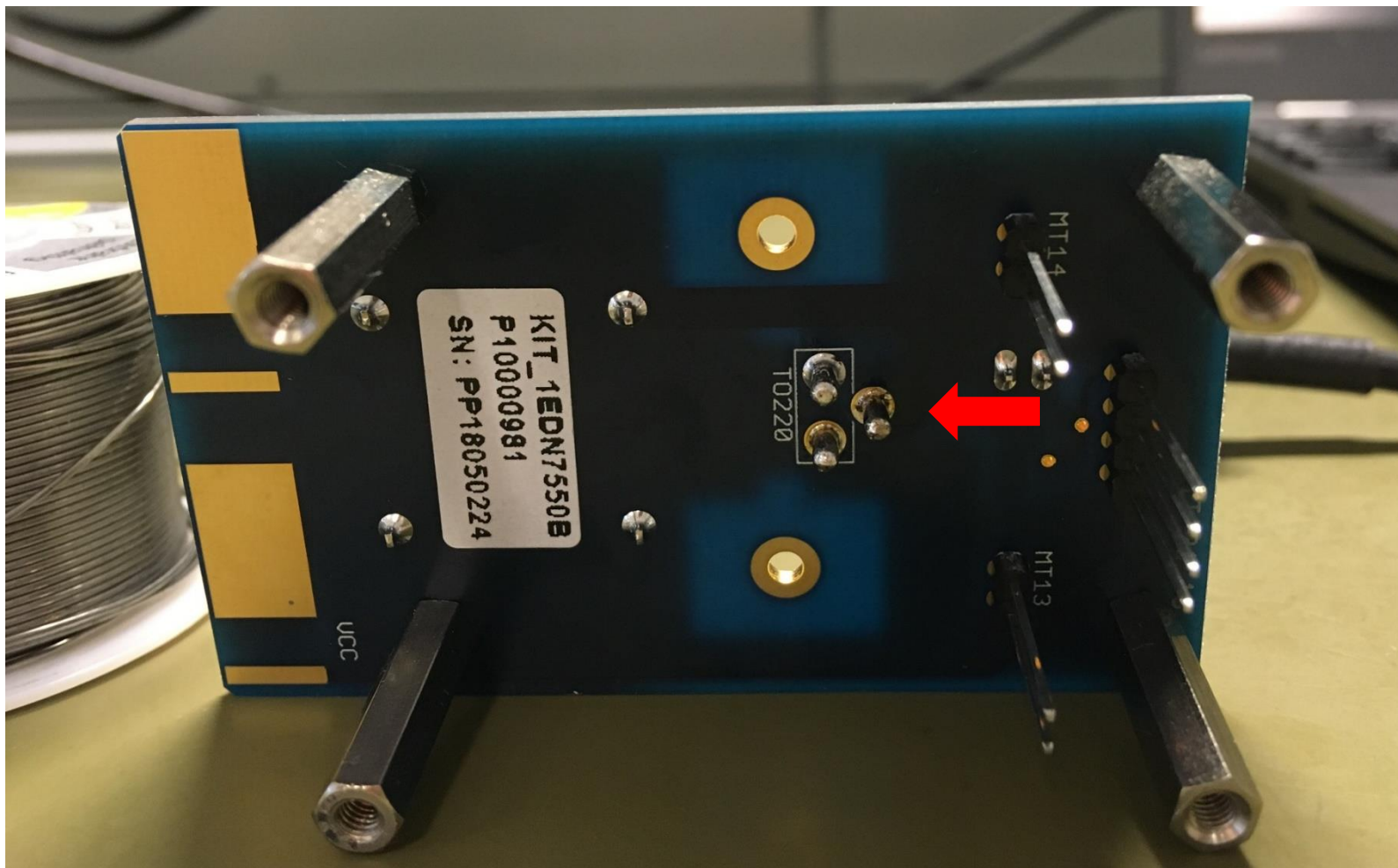

Step 5: MOSFETs placement into the sockets

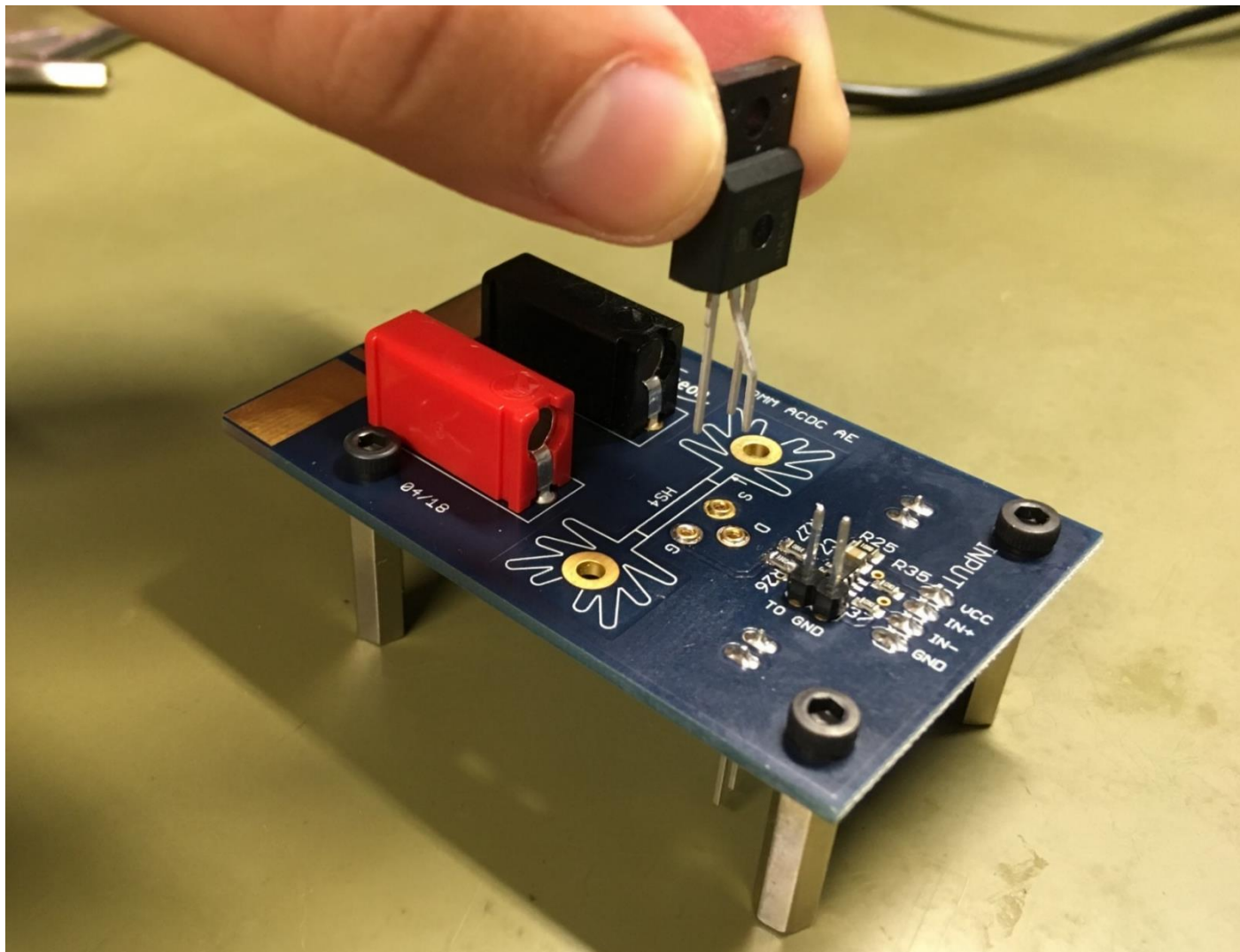

Step 6: Heatsink mounting (optional)

- > Solder the heatsink if the board is used in high voltage scenarios
- > In basic measurements it is not necessary
- > See next slide for further information on how to properly mount the MOSFETs to the heatsink

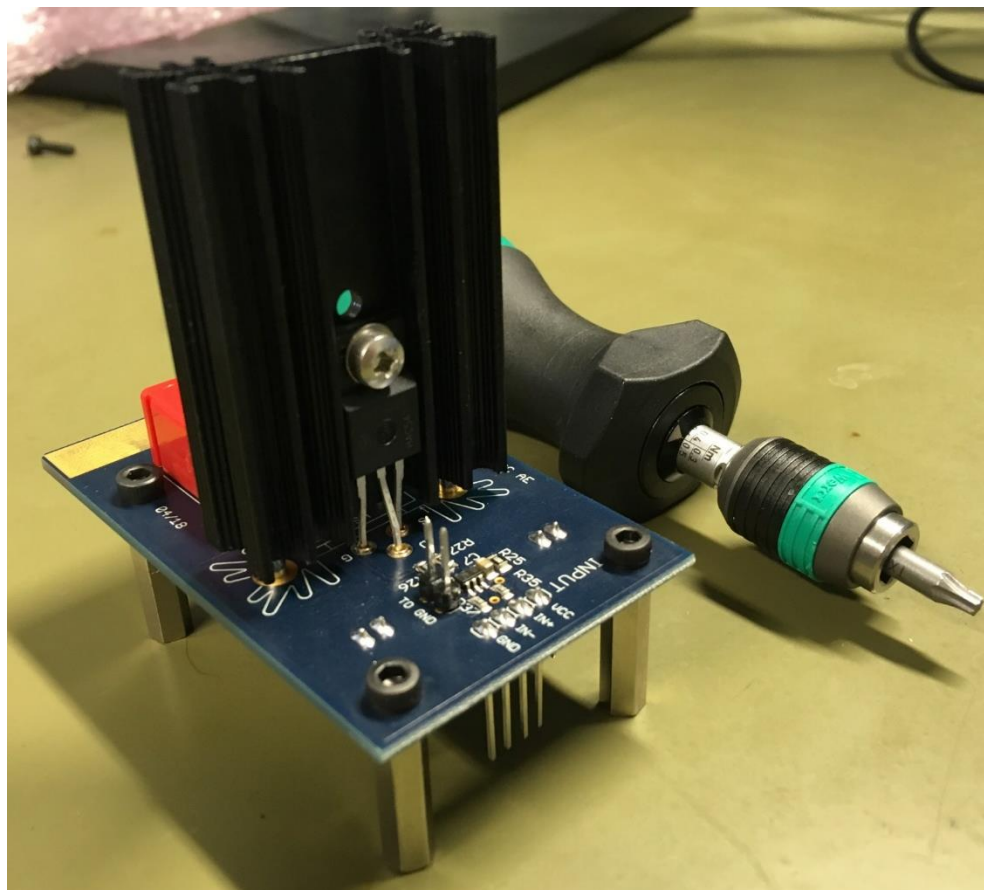

TO-220 MOSFET mounting to the heatsink

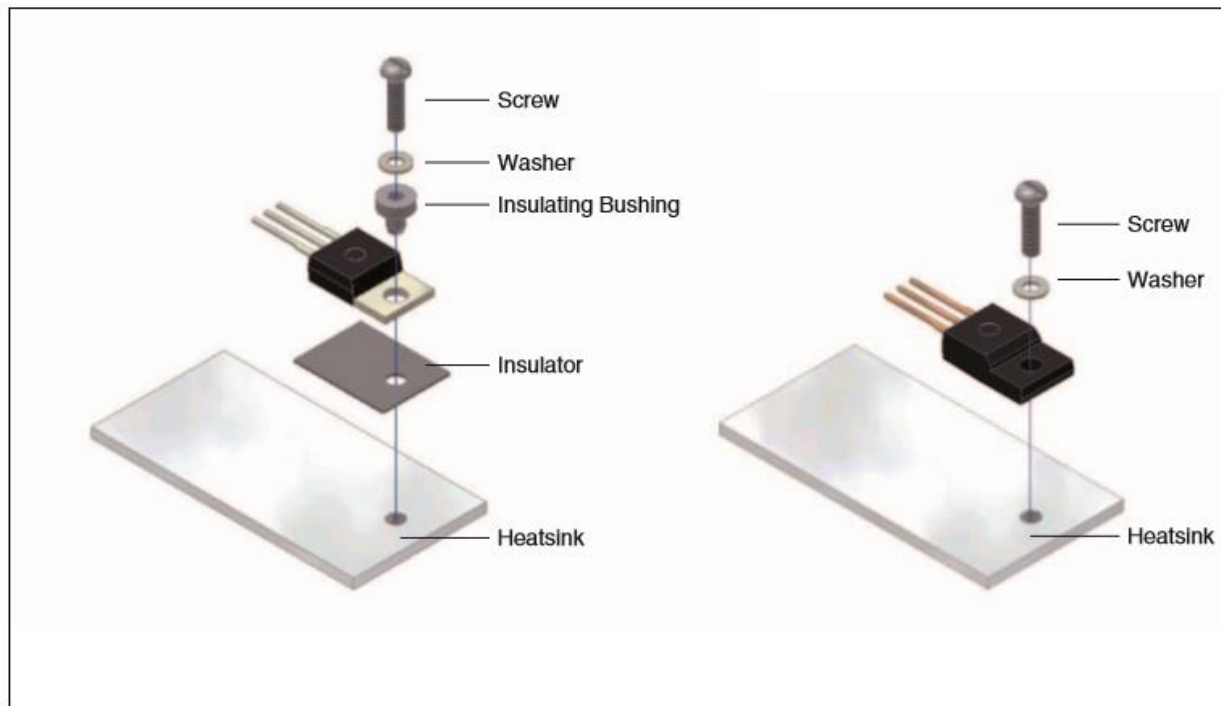

Package	Typ. Torque [Nm]	Max. Torque [Nm]	Comment
PG-TO220	0.6	0.7	Screw M3
PG-TO220 FullPAK	0.5	0.7	Screw M2.5

- > Recommendations for assembly of Infineon TO packages:
https://www.infineon.com/dgdl/Infineon-Package_recommendations_for_assembly_of_Infineon_TO_packages-AN-v01_00-EN.pdf?fileId=db3a30431936bc4b011938532f885a38

Step 7: BNC connectors soldering

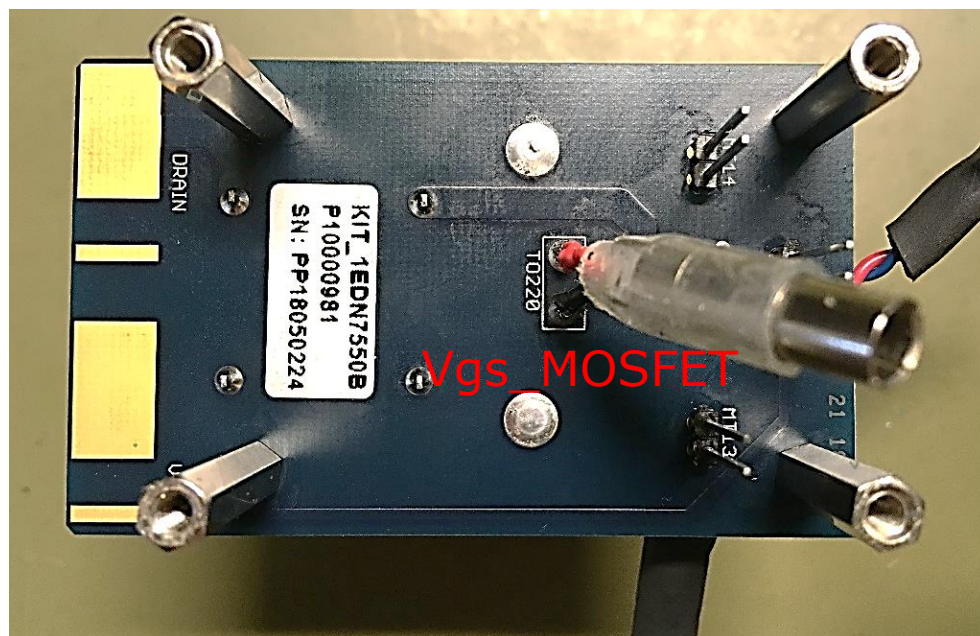

- > To measure the input PWM signal apply a differential voltage probe between the IN+ and IN- pins

Instrumentation for driver supply generation

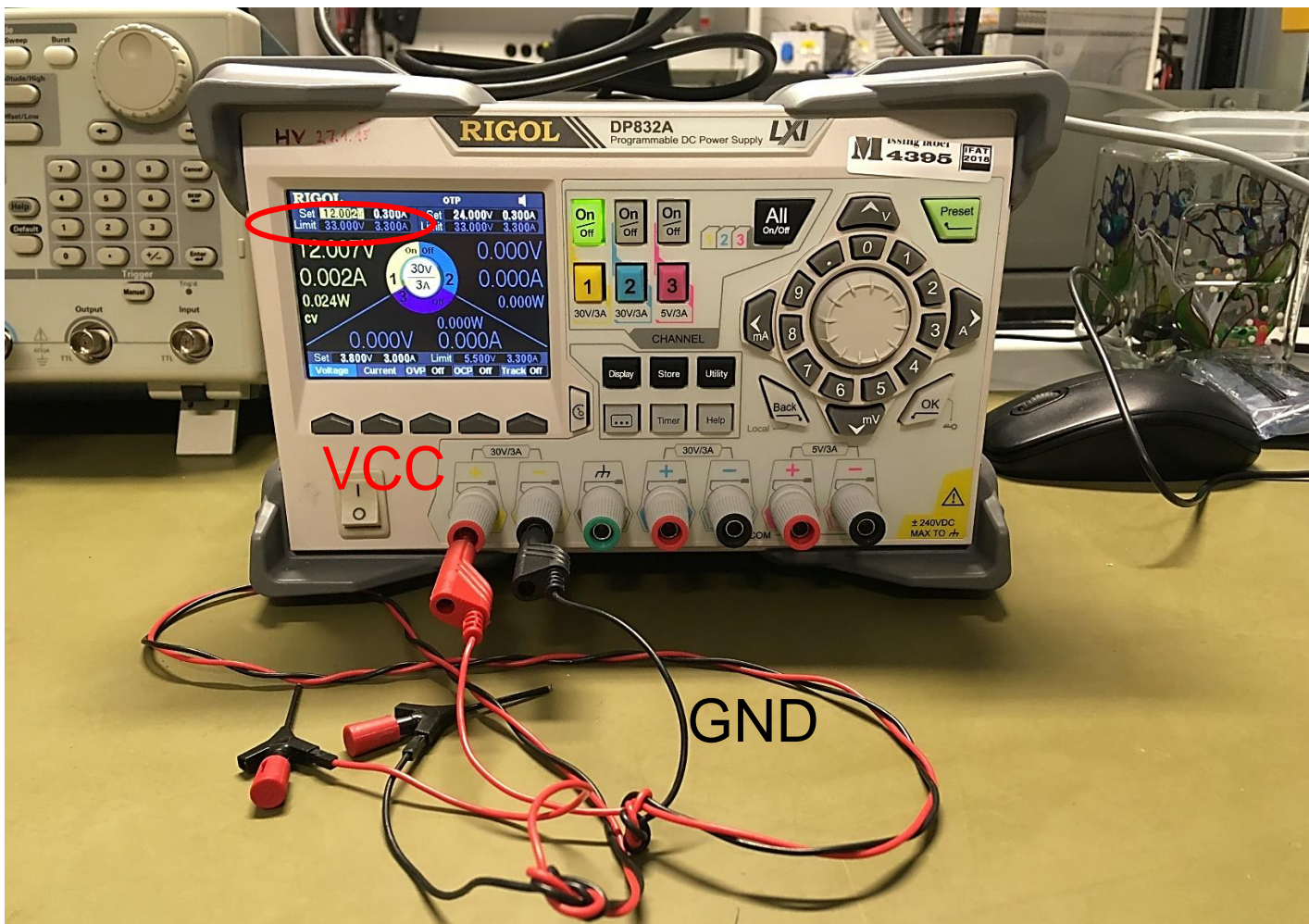

- > $V_{cc} = 12\text{ V}$ for CoolMOS™ and 8 V for OptiMOS™
- > Set the current limit below 1 A (0.3A e.g.)

Instrumentation for PWM signals generation

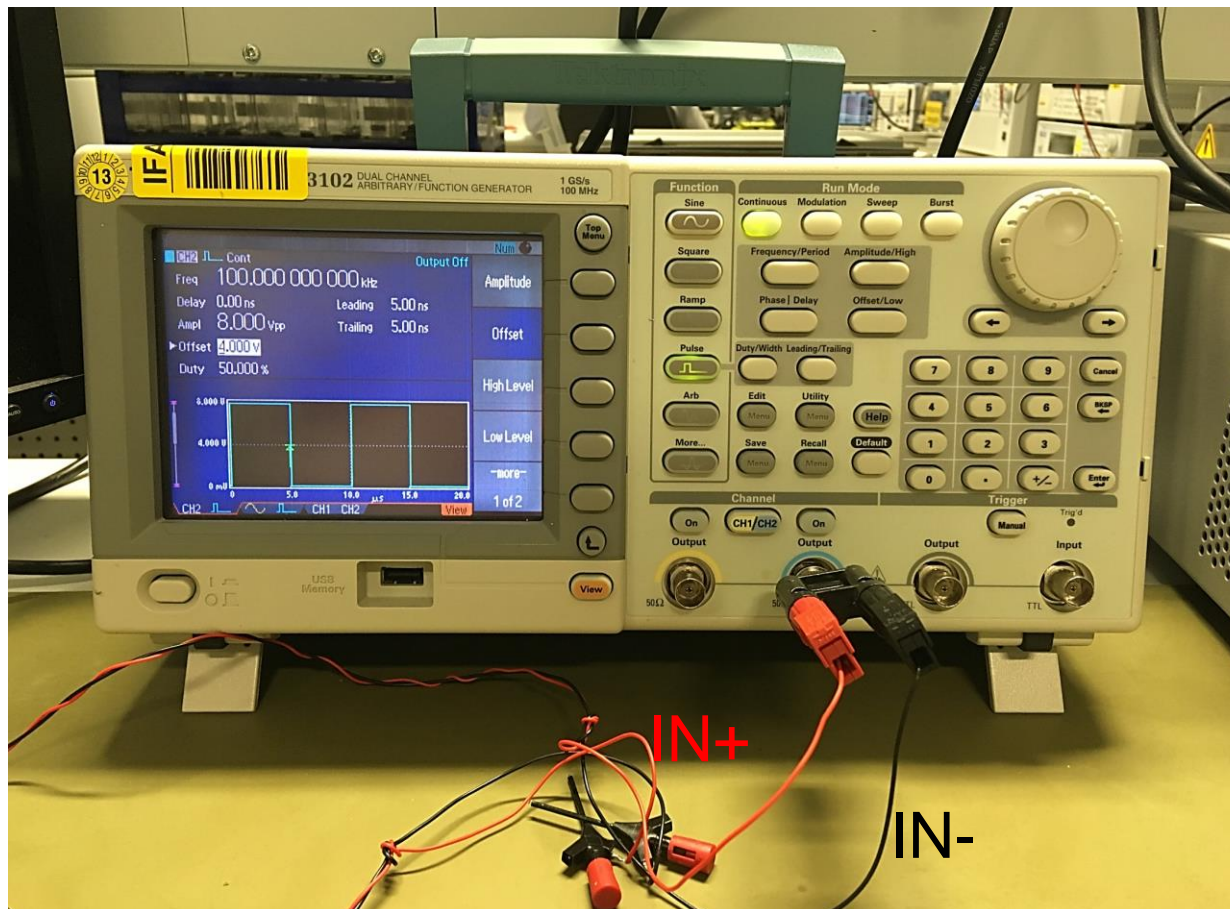

- > Generate a PWM signal with at least 8 V amplitude
- > To generate a 3.3 V PWM signal change the input resistances R35,R37 to 33 k Ω
- > To generate a 5 V PWM signal change the input resistances R35,R37 to 52 k Ω

Connections

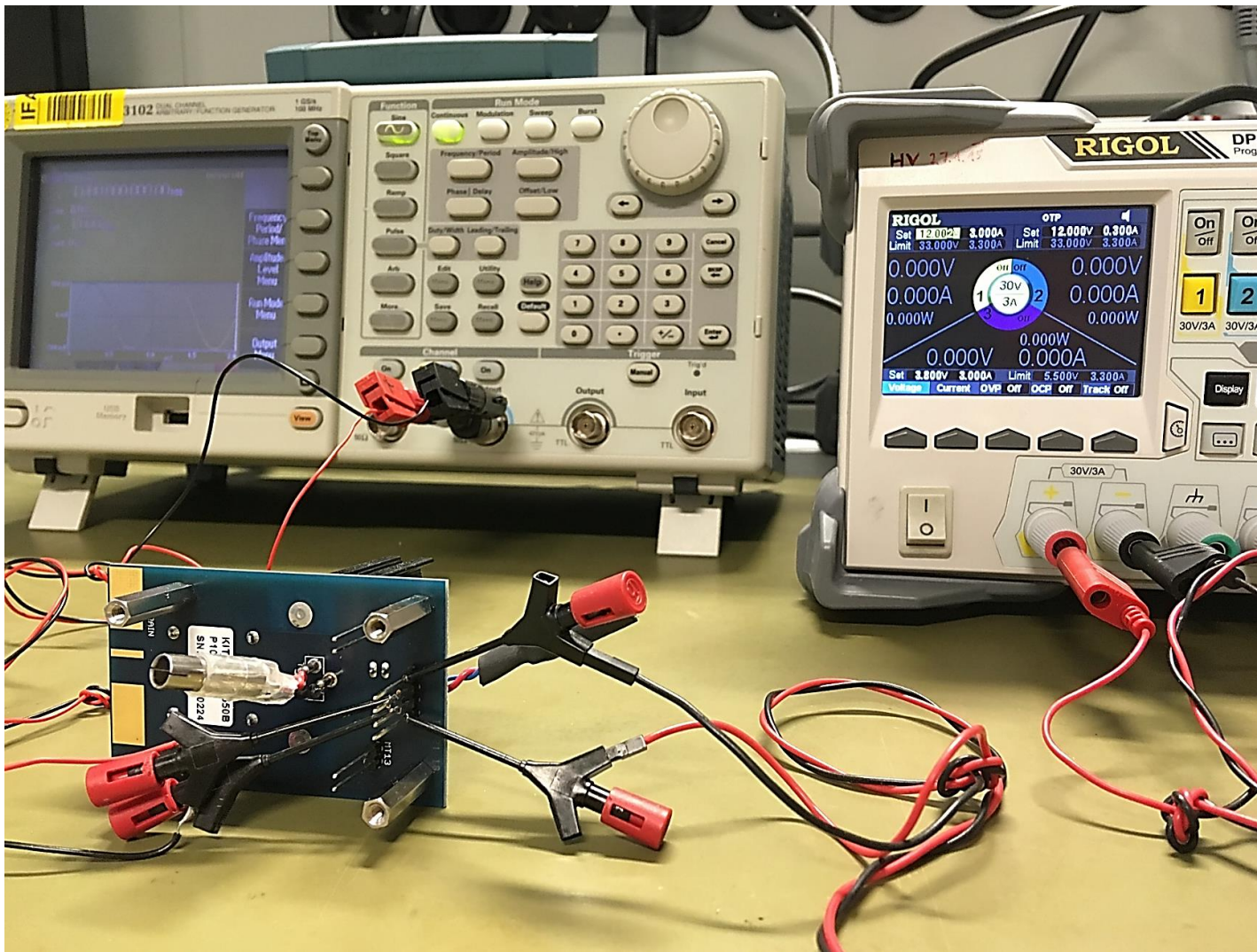

Instrumentation for signals evaluation

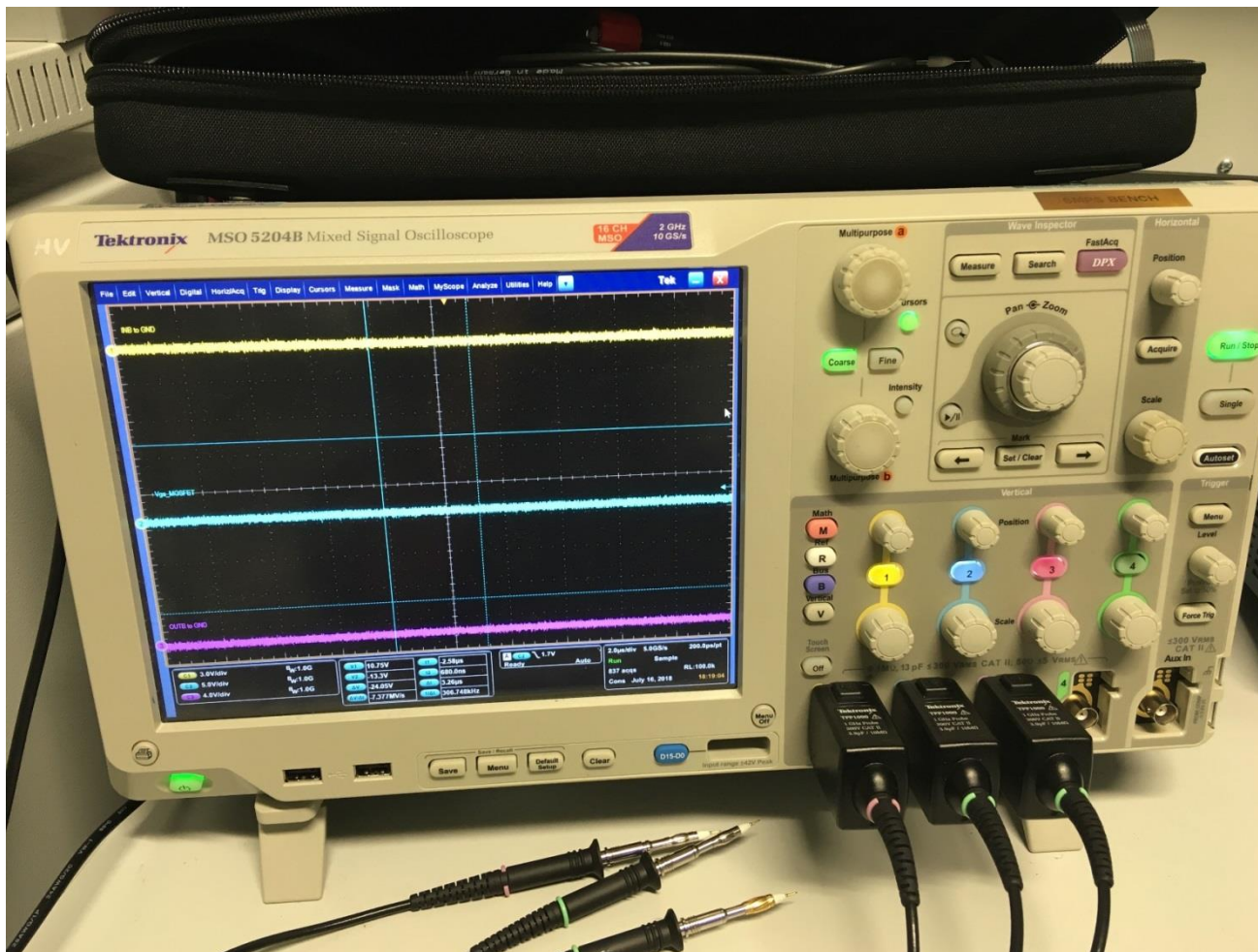

- > Voltage probes used: Tetronix TPP1000 1 GHz, 3.9 pF

Oscilloscope waveforms

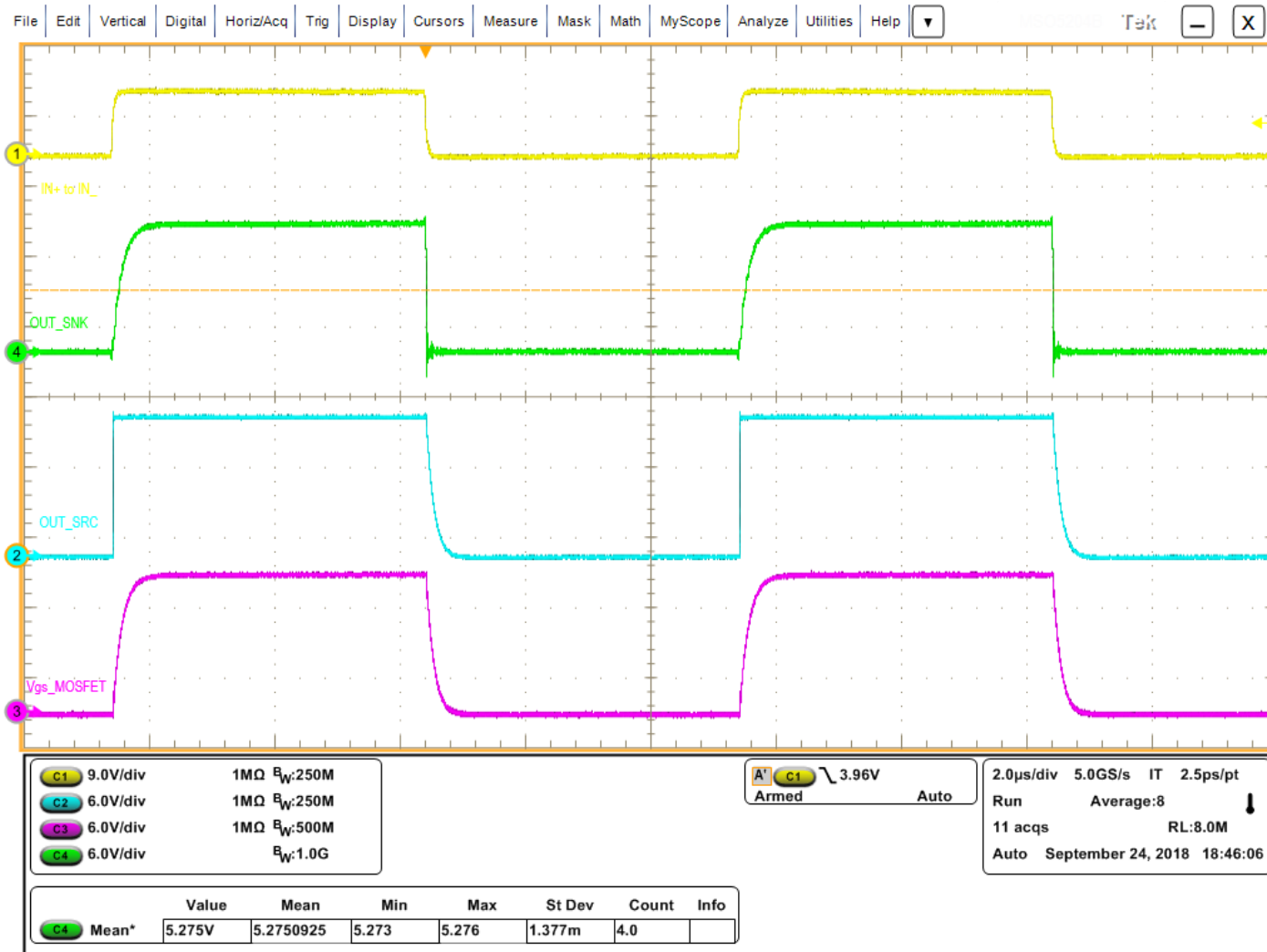

Evaluation of 1EDN7550B robustness to DC offsets: measurement setup

- > The truly differential input 1EDN7550B gate driver is able to withstand DC offsets between the microcontroller ground (IN-) and the driver ground (GND)

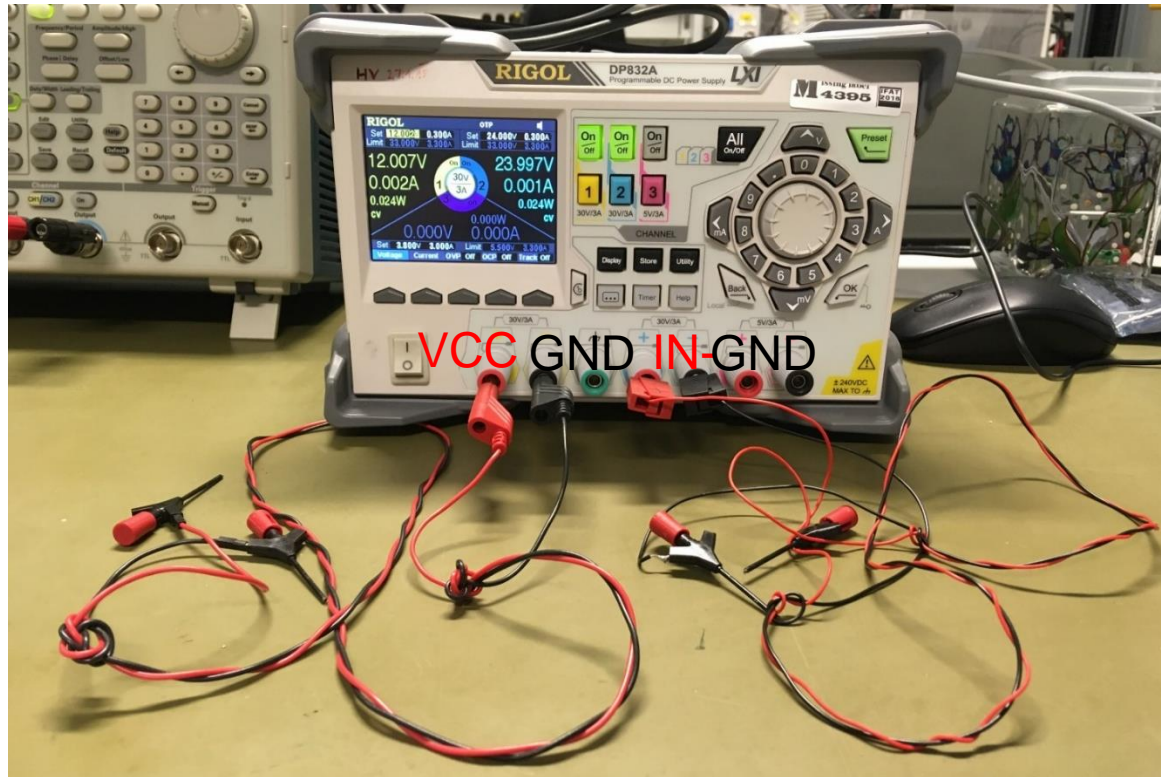

- > How to test: use the 2nd channel of the DC source generator to create an offset between IN- and GND
- > How to measure: soldering a BNC connector between IN- and GND to measure the DC offset

Evaluation of 1EDN7550B robustness to DC offsets: measurement results

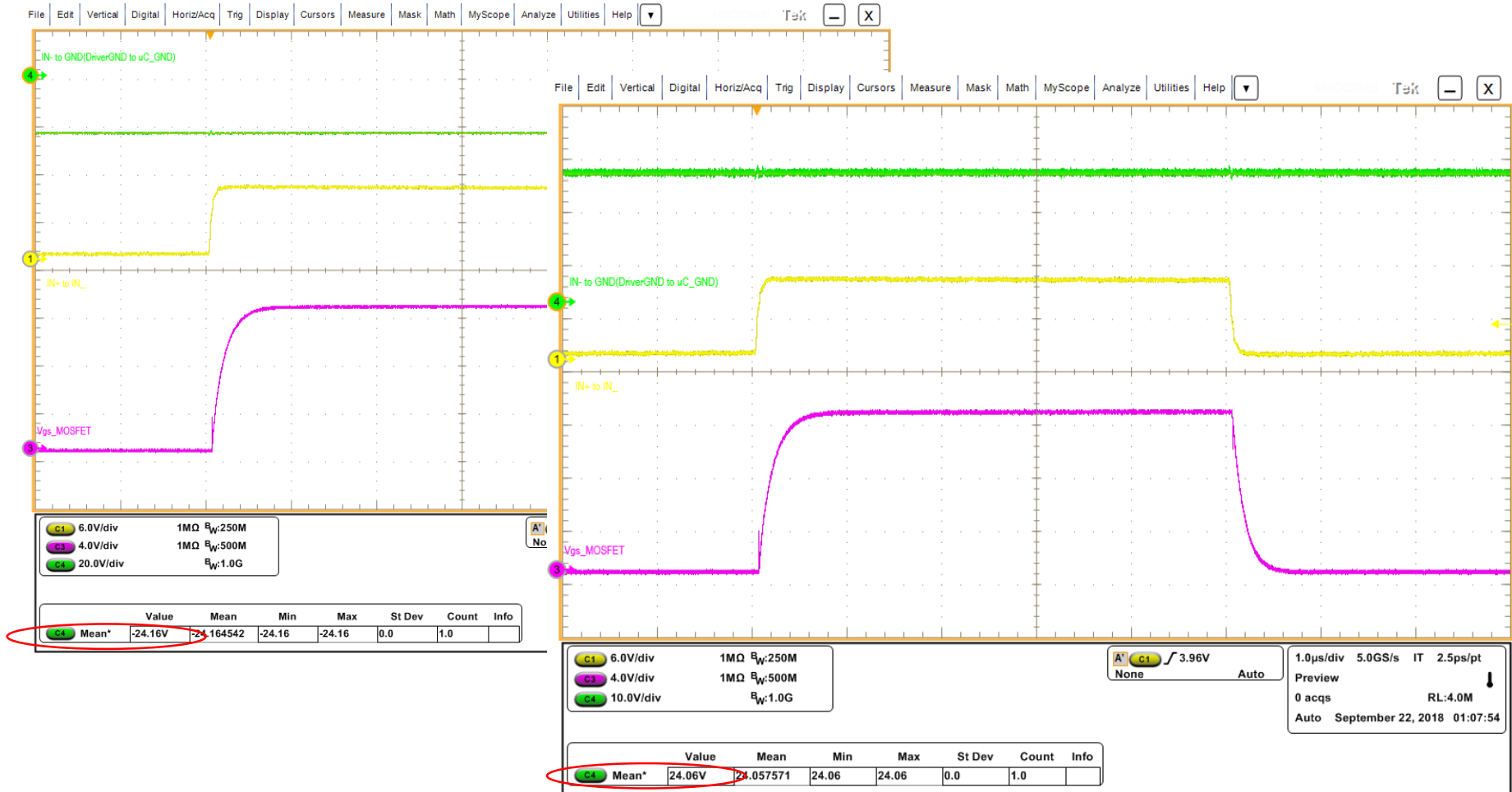

Conclusion: contrary to a standard 1-channel low-side driver, the 1EDN7550B properly turns ON and OFF with DC GND shifts between the microcontroller ground and the driver ground

How – Changing the gate resistances and/or the gate MOSFET

What – Monitor the impact on the gate signal delivered to the MOSFET

Equivalent model of the driving circuit

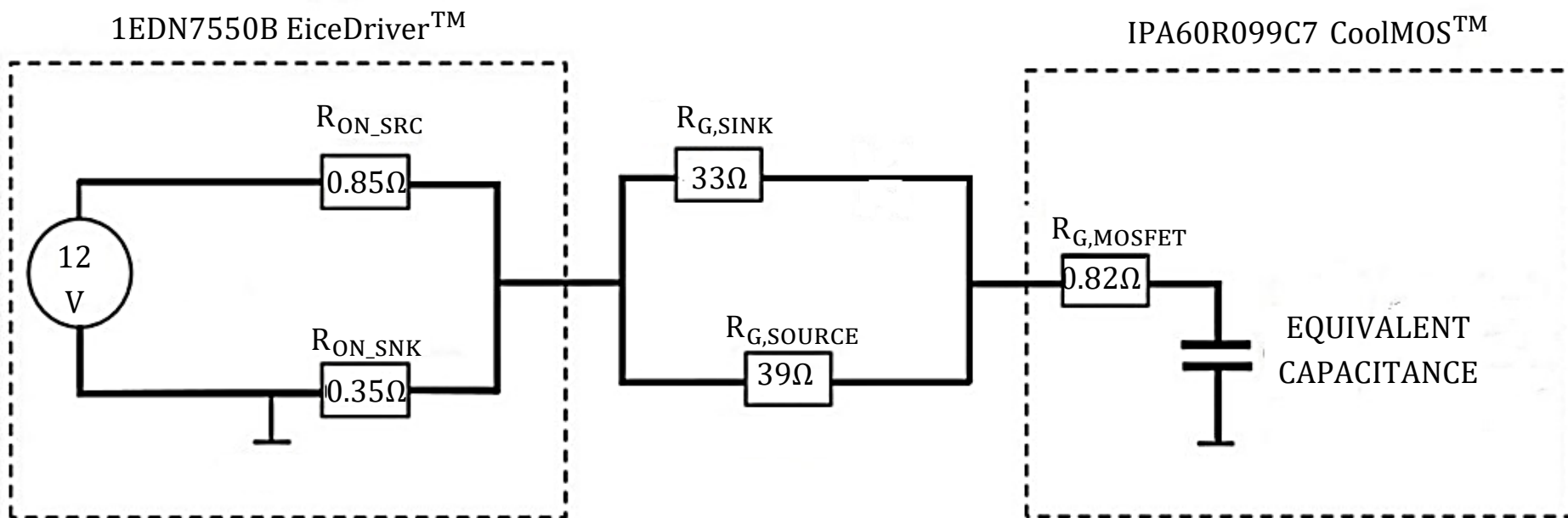

C_{LOAD} calculation for IPA60R099C7



Gate to drain charge	Q_{gd}	-	14	-	nC	$V_{DD}=400V, I_D=9.7A, V_{GS}=0 \text{ to } 10V$
Gate charge total	Q_g	-	42	-	nC	$V_{DD}=400V, I_D=9.7A, V_{GS}=0 \text{ to } 10V$

$$Q_{LOAD} = Q_g - Q_{gd} = 28 \text{ nC} \rightarrow C_{LOAD} = \frac{Q_{LOAD}}{V_{GS}} = 2.8 \text{ nF} \text{ for } V_{GS} = 10 \text{ V} \rightarrow$$

$$C_{LOAD} \approx 2.8 \text{ nF} \text{ for } V_{GS} = 12 \text{ V}$$

Rise/fall times

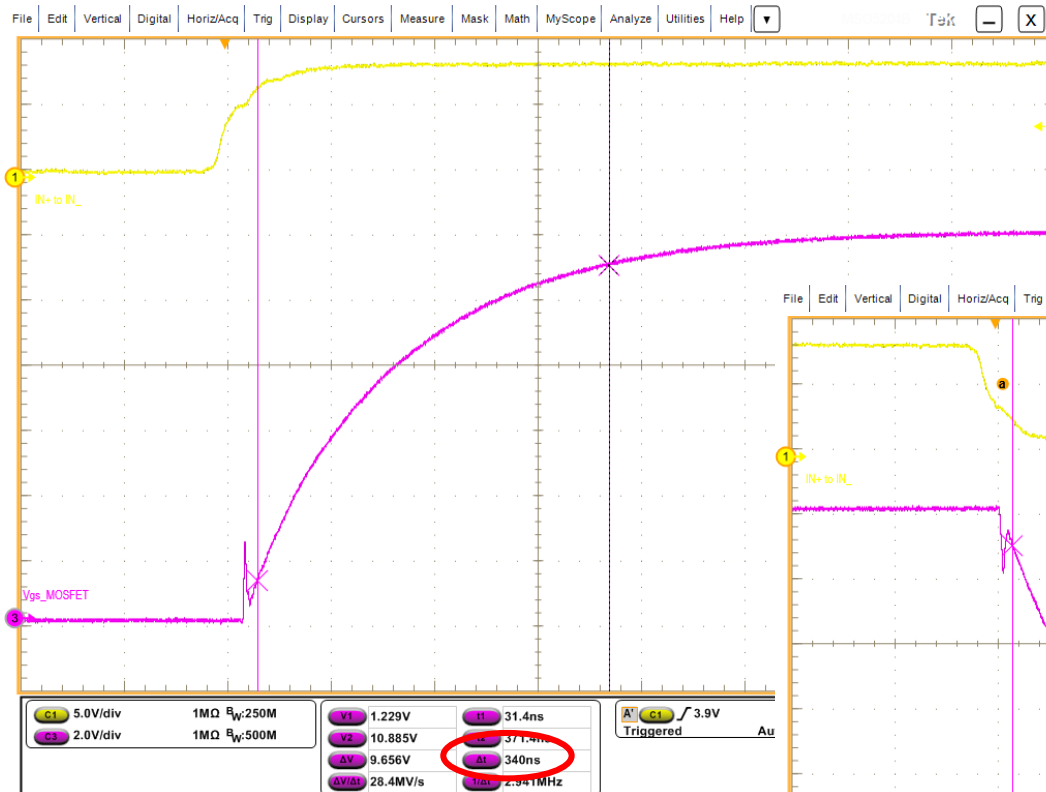

$R_{G,SOURCE} = 39 \Omega$
 $R_{G,SINK} = 33 \Omega$
 MOSFET = IPA60R099C7
 $R_{G,MOSFET} = 0.82 \Omega$
 $C_{LOAD} \approx 2.8 \text{ nF}$

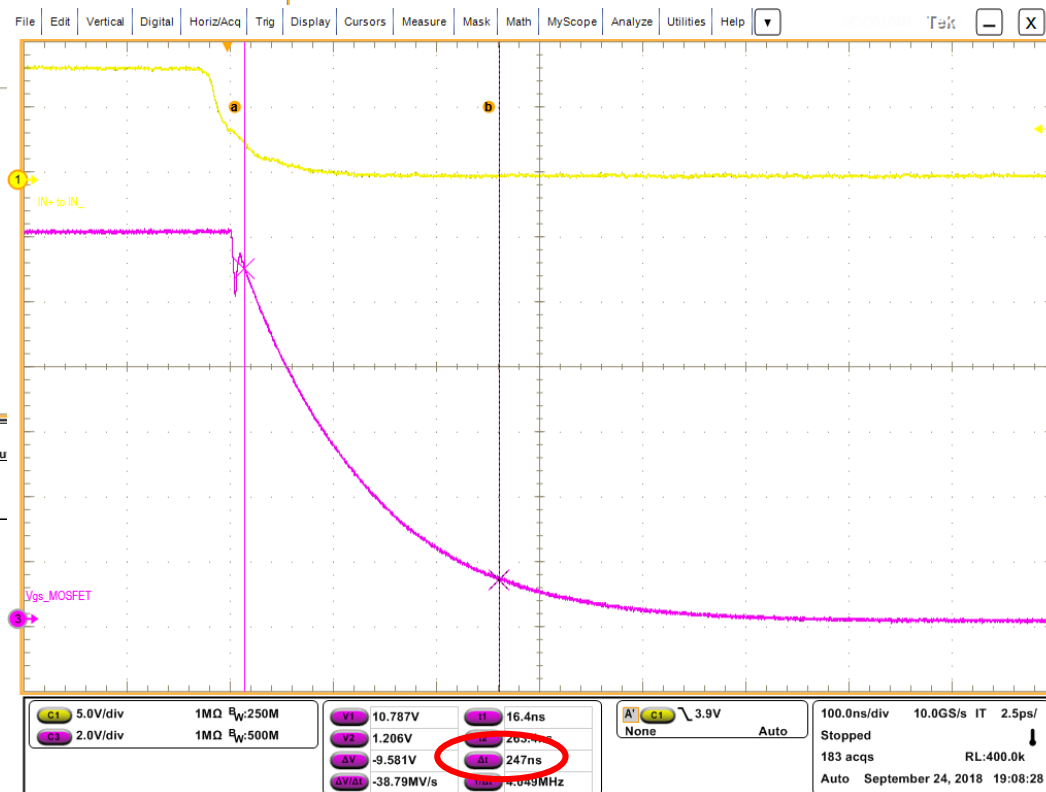

Gate resistors replacement

$$R_{G,SOURCE} = 39 \Omega \quad \rightarrow \quad 24 \Omega$$

$$R_{G,SINK} = 33 \Omega \quad \rightarrow \quad 20 \Omega$$

MOSFET = IPA60R099C7

Rise/fall times: New set of gate resistances

$R_{G,SOURCE} = 24 \Omega$
 $R_{G,SINK} = 20 \Omega$
 MOSFET = IPA60R099C7
 $R_{G,MOSFET} = 0.82 \Omega$
 $C_{LOAD} \approx 2.8 \text{ nF}$

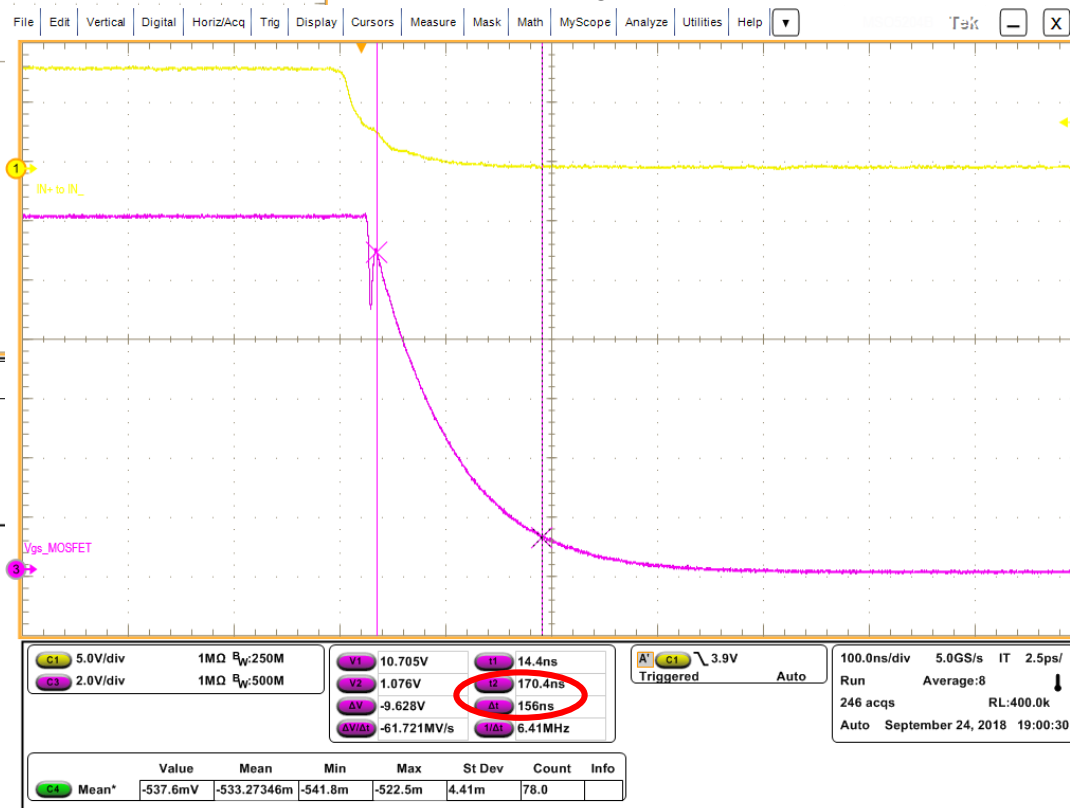

Gate resistors replacement

$$R_{G,SOURCE} = 24 \Omega \quad \rightarrow \quad 51 \Omega$$

$$R_{G,SINK} = 20 \Omega \quad \rightarrow \quad 43 \Omega$$

MOSFET = IPA60R099C7

Rise/fall times: New set of gate resistances

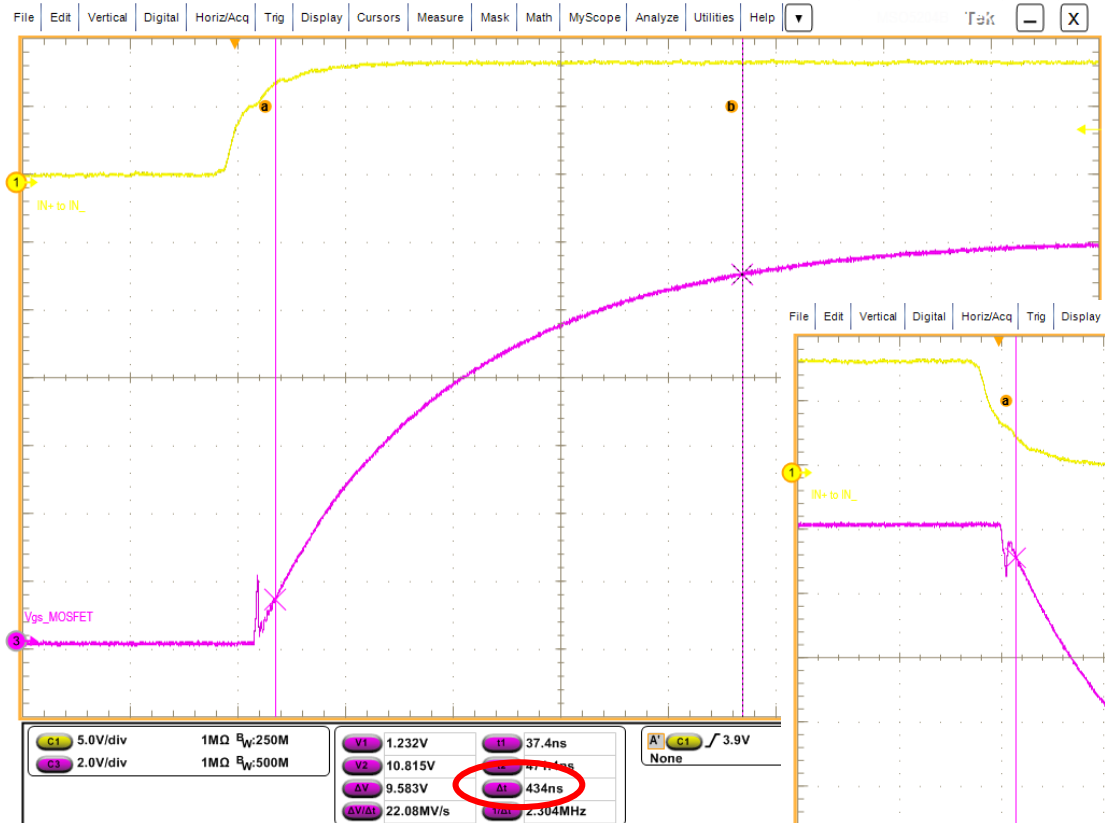

$$R_{G,SOURCE} = 51 \Omega$$

$$R_{G,SINK} = 43 \Omega$$

MOSFET = IPA60R099C7

$$R_{G,MOSFET} = 0.82 \Omega$$

$$C_{LOAD} \approx 2.8 \text{ nF}$$

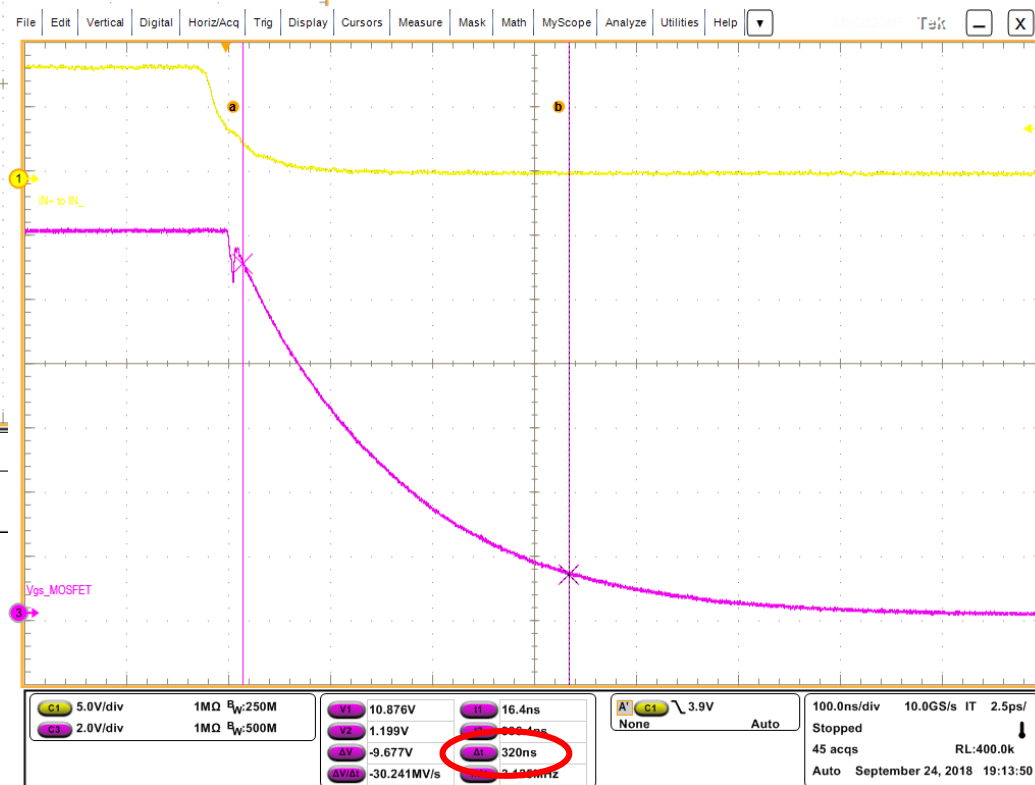

MOSFET replacement

IPA60R099C7 → IPA60R280CFD7

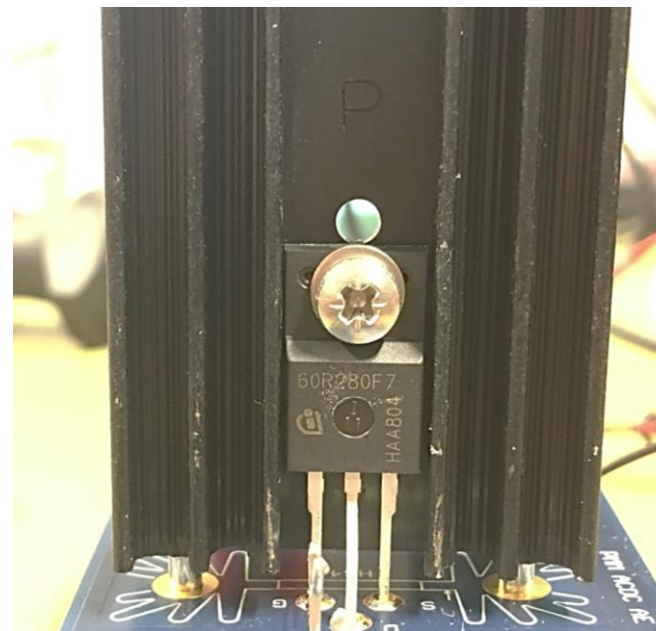
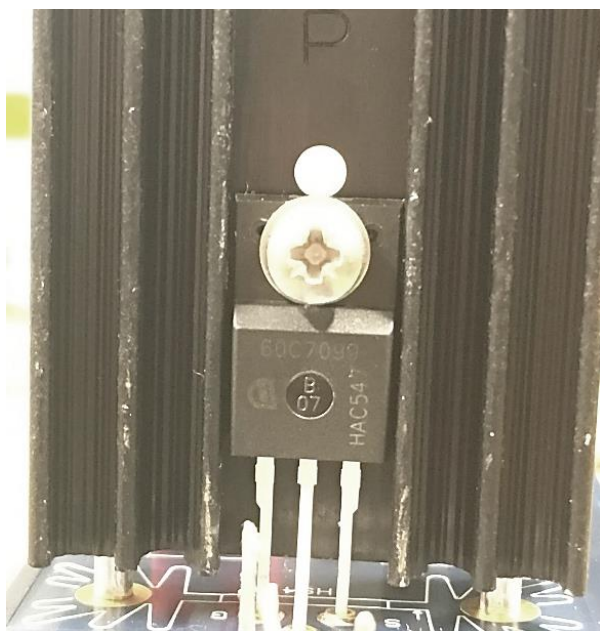

Gate to drain charge	Q_{gd}	-	5	-	nC	$V_{DD}=400V, I_D=5.0A, V_{GS}=0 \text{ to } 10V$
Gate charge total	Q_g	-	18	-	nC	$V_{DD}=400V, I_D=5.0A, V_{GS}=0 \text{ to } 10V$

$$C_{LOAD} \approx \frac{13 \text{ nC}}{10 \text{ V}} = 1.3 \text{ nF for } V_{GS} = 12 \text{ V}$$

Rise/fall times: New MOSFET

$R_{G,SOURCE} = 51 \Omega$
 $R_{G,SINK} = 43 \Omega$
 MOSFET = IPA60R280CFD7
 $R_{G,MOSFET} = 11 \Omega$
 $C_{LOAD} \approx 1.3 \text{ nF}$

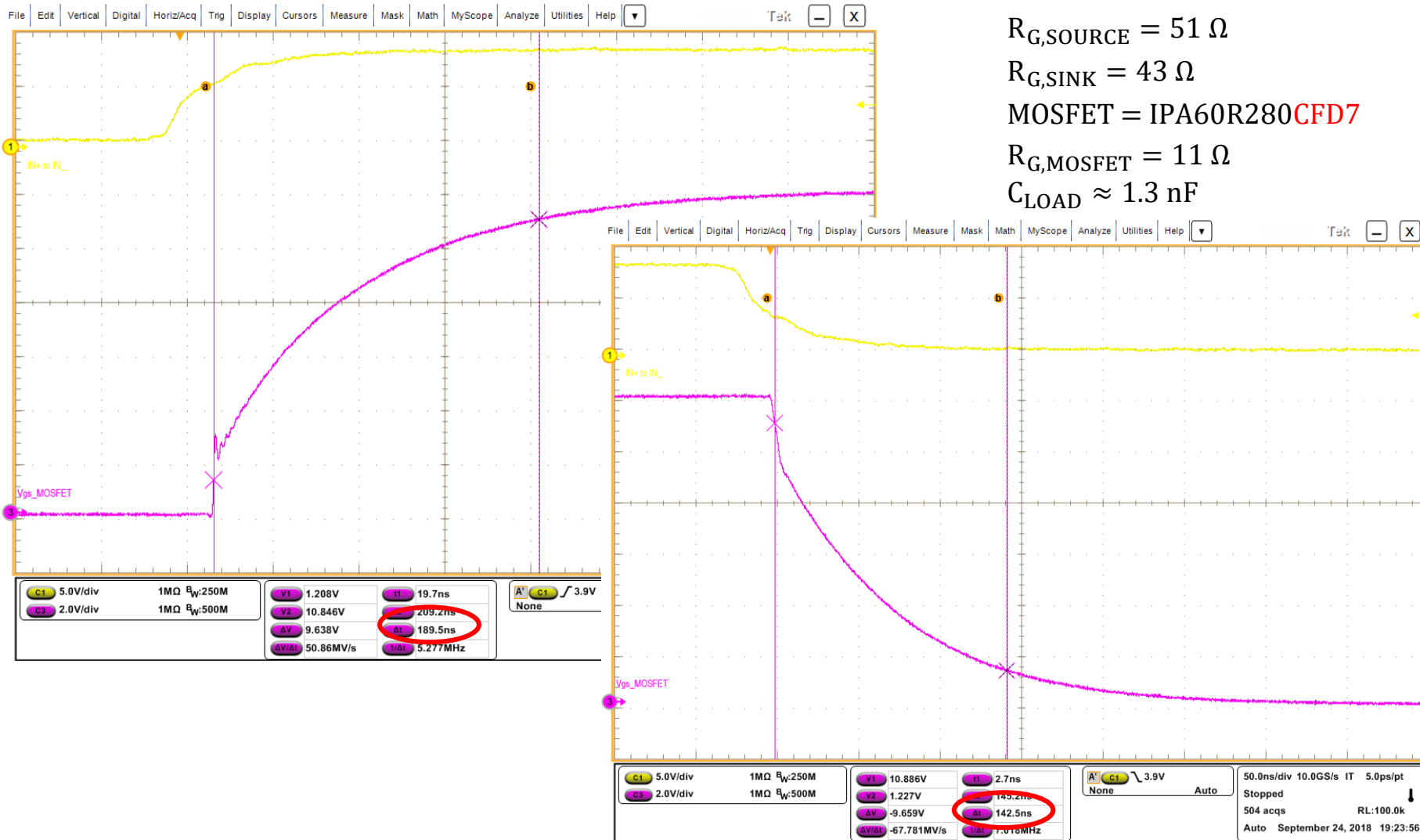

MOSFET replacement

IPA60R280CFD7 → IPA60R180P7

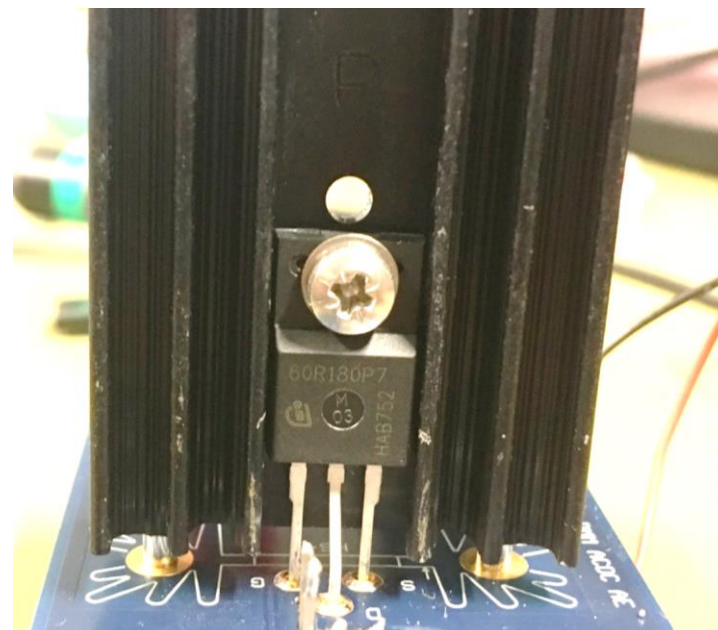
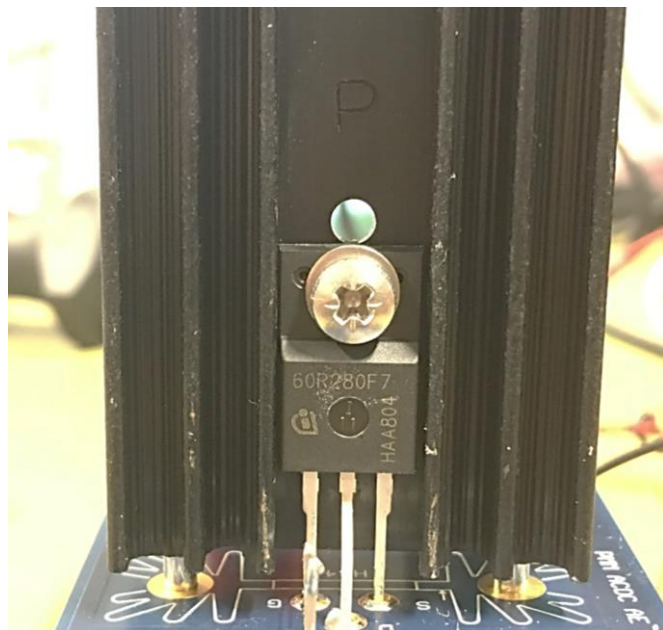

Gate to drain charge	Q_{gd}	-	8	-	nC	$V_{DD}=400V, I_D=5.6A, V_{GS}=0 \text{ to } 10V$
Gate charge total	Q_g	-	25	-	nC	$V_{DD}=400V, I_D=5.6A, V_{GS}=0 \text{ to } 10V$

$$C_{LOAD} \approx \frac{19 \text{ nC}}{10 \text{ V}} = 1.9 \text{ nF for } V_{GS} = 12 \text{ V}$$

Rise/fall times: New MOSFET

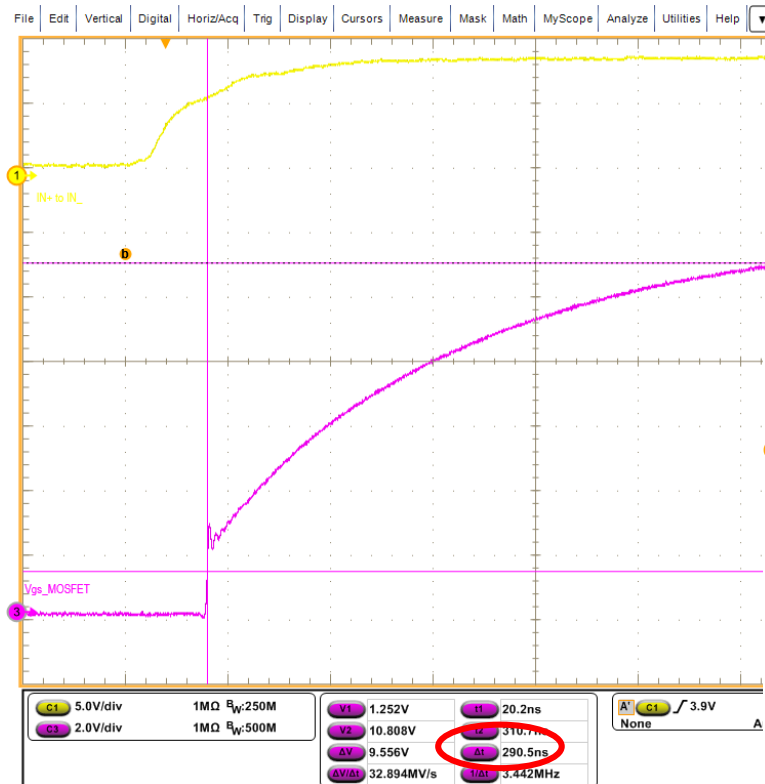

$R_{G,SOURCE} = 51 \Omega$
 $R_{G,SINK} = 43 \Omega$
 MOSFET = IPA60R180P7
 $R_{G,MOSFET} = 11 \Omega$
 $C_{LOAD} \approx 1.9 \text{ nF}$

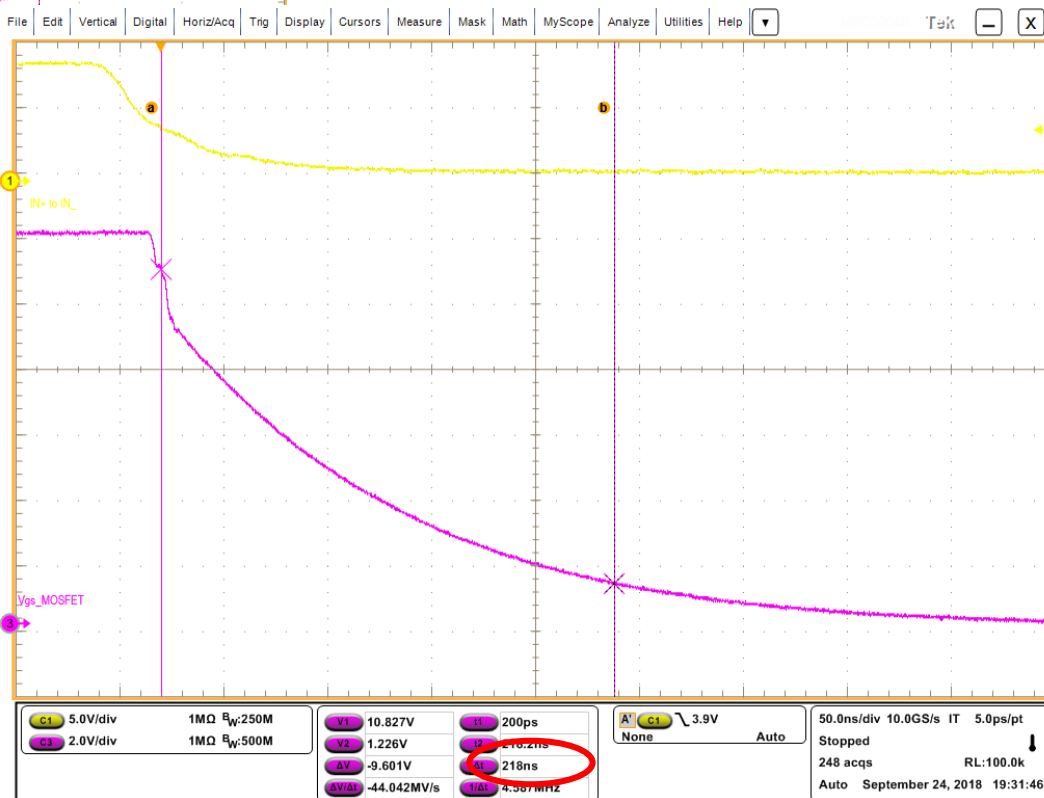

Additional notes

- > Note that the MOSFET is not turned-on or -off, you are only charging/discharging the gate-to-source capacitance
- > Changing the gate resistors and the MOSFETs, you are changing the load for the driver
- > If you want to turn-on or turn-off the MOSFET, you must integrate the board in a proper circuit
- > You can not apply directly the voltage (e.g 400 V) across the MOSFET through the banana connectors on the board
- > You must limit the input current from the DC source generator → add an inductance
- > You must create a freewheeling path for the current when MOSFET is off

Example: boost converter, simple MOSFET in clamped inductive mode

IMPORTANT NOTICE and WARNINGS

IMPORTANT NOTICE

The information given in this document shall in no event be regarded as a guarantee of conditions or characteristics ("Beschaffenhheitsgarantie").

With respect to any examples, hints or any typical values stated herein and/or any information regarding the application of the product, Infineon Technologies hereby disclaims any and all warranties and liabilities of any kind, including without limitation warranties of non-infringement of intellectual property rights of any third party.

In addition, any information given in this document is subject to customer's compliance with its obligations stated in this document and any applicable legal requirements, norms and standards concerning customer's products and any use of the product of Infineon Technologies in customer's applications.

The data contained in this document is exclusively intended for technically trained staff. It is the responsibility of customer's technical departments to evaluate the suitability of the product for the intended application and the completeness of the product information given in this document with respect to such application. For further information on the product, technology, delivery terms and conditions and prices please contact your nearest Infineon Technologies office (www.infineon.com).

WARNINGS

Due to technical requirements products may contain dangerous substances. For information on the types in question please contact your nearest Infineon Technologies office.

Except as otherwise explicitly approved by Infineon Technologies in a written document signed by authorized representatives of Infineon Technologies, Infineon Technologies' products may not be used in any applications where a failure of the product or any consequences of the use thereof can reasonably be expected to result in personal injury.



Part of your life. Part of tomorrow.

