

AVNET[®] ABACUS

samtec

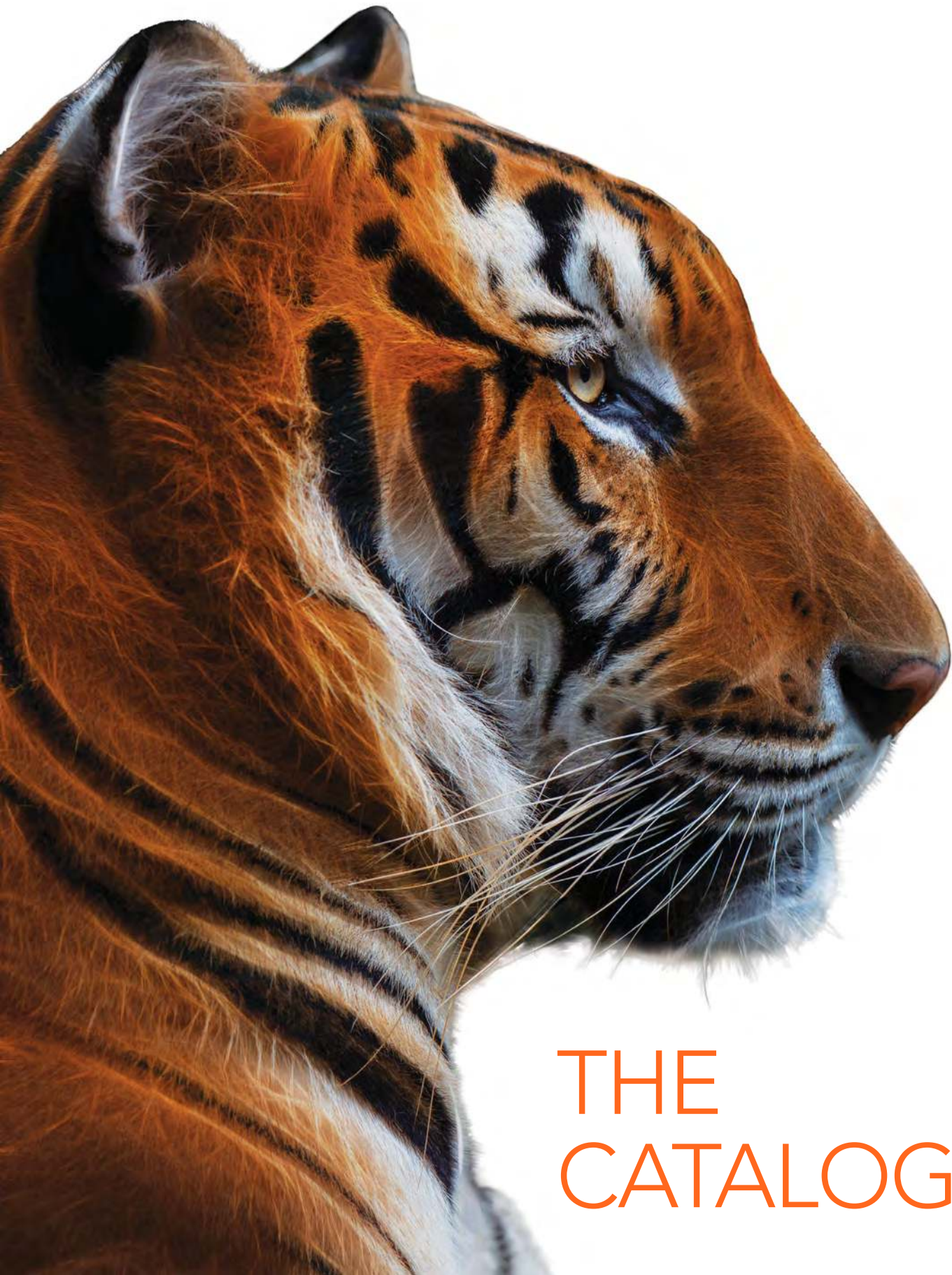

THE
CATALOGUE

A DIFFERENT BREED OF CAT

INNOVATIVE TECHNOLOGIES • SUDDEN SERVICE®

Founded in 1976, Samtec is much more than just another connector company. We put people first, along with a commitment to **exceptional service**, **quality products** and **innovative technologies** that take the industry further faster. This is enabled by our unique, **fully integrated business model**, which allows for true **collaboration and innovation** without the limits of traditional business models.

We believe that taking care of our customers and our employees is paramount in how we approach our business, and this belief is deeply ingrained throughout Samtec worldwide.

INNOVATIVE TECHNOLOGIES

At Samtec, integration leads to innovation. We are leading the way in high-performance system design and support for complete system optimization from **SILICON-TO-SILICON™**. Samtec is positioned to produce solutions quickly, with higher densities, faster speeds and smaller footprints to meet the demands of next generation systems.

From standard cataloged products to unique high-performance design, Samtec's **SOLUTION BLOCKS** are designed to support any interconnectivity need, regardless of application, performance requirements or environment.

Silicon-to-Silicon



HIGH-SPEED BOARD-TO-BOARD



HIGH-SPEED CABLE



OPTICS



RF

Core Board-to-Board



RUGGED/POWER

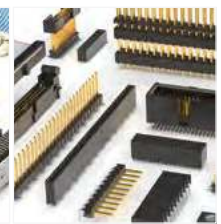

FLEXIBLE STACKING

SUDDEN SERVICE®

Samtec is the service leader in the industry, offering unmatched technical support, free product samples and access to online resources, and innovative online tools to help streamline the design process.



CORE SERVICE



TECH SUPPORT



WEB TOOLS



SYSTEM SERVICE

HIGH-SPEED BOARD-TO-BOARD

OPEN-PIN-FIELD ARRAYS | GROUND PLANE STRIPS | EDGE CARDS | ULTRA-MICRO | BACKPLANE

ExaMAX[®]

QSERIES[®]

samtec

XCede HD

ACCELERATE[®]mP

EDGE RATE SYSTEM

ACCELERATE[®]HD

ACCELERATE[®]HP

NOVARAY[®]

SEARAY[™]

RAZOR[™] BEAM SYSTEM

RUGGED/POWER

ULTRA RUGGED | BLADE POWER | RUGGED I/O | BOARD-TO-BOARD | DISCRETE WIRE

mPOWER[®]

EDGE RATE SYSTEM

URSA I/O
ULTRA RUGGED CONTACT SYSTEM

TIGER EYE SYSTEM

miniMATE[®]

FLEXIBLE STACKING

LOW PROFILE | PASS-THROUGH | ONE-PIECE | SKYSCRAPERS | SHROUDED HEADERS | IDC SYSTEMS

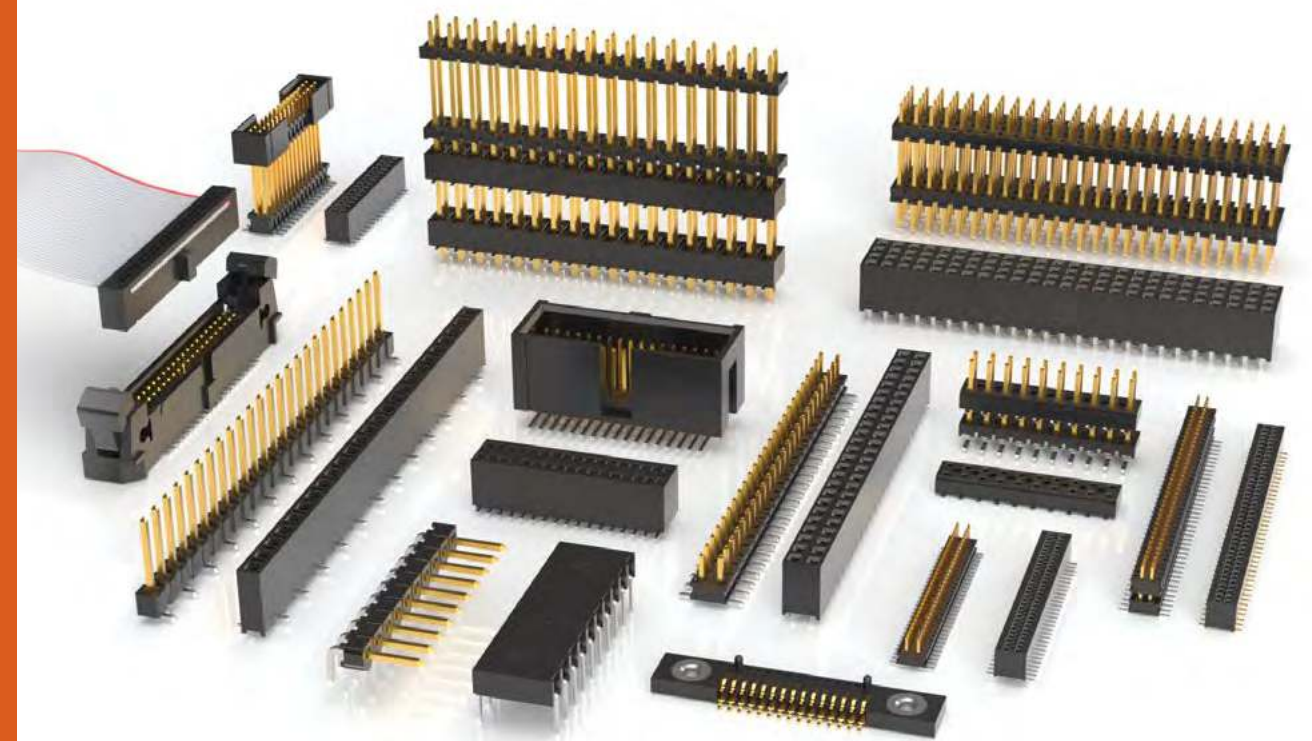

HIGH-SPEED CABLES

FLYOVER® | MID-BOARD & PANEL | BACKPLANE | MICRO COAX & TWINAX



FLYOVER®

SI-FLY™

ACCELERATE®

ACCELERATE®HP

NOVARAY I/O

ExaMAX®

SEARAY™

NOVARAY®

GENERATE™

OPTICS

MICRO FLYOVER SYSTEM™ | RUGGED OPTICS | PCI EXPRESS®-OVER-FIBER | NEXT GEN

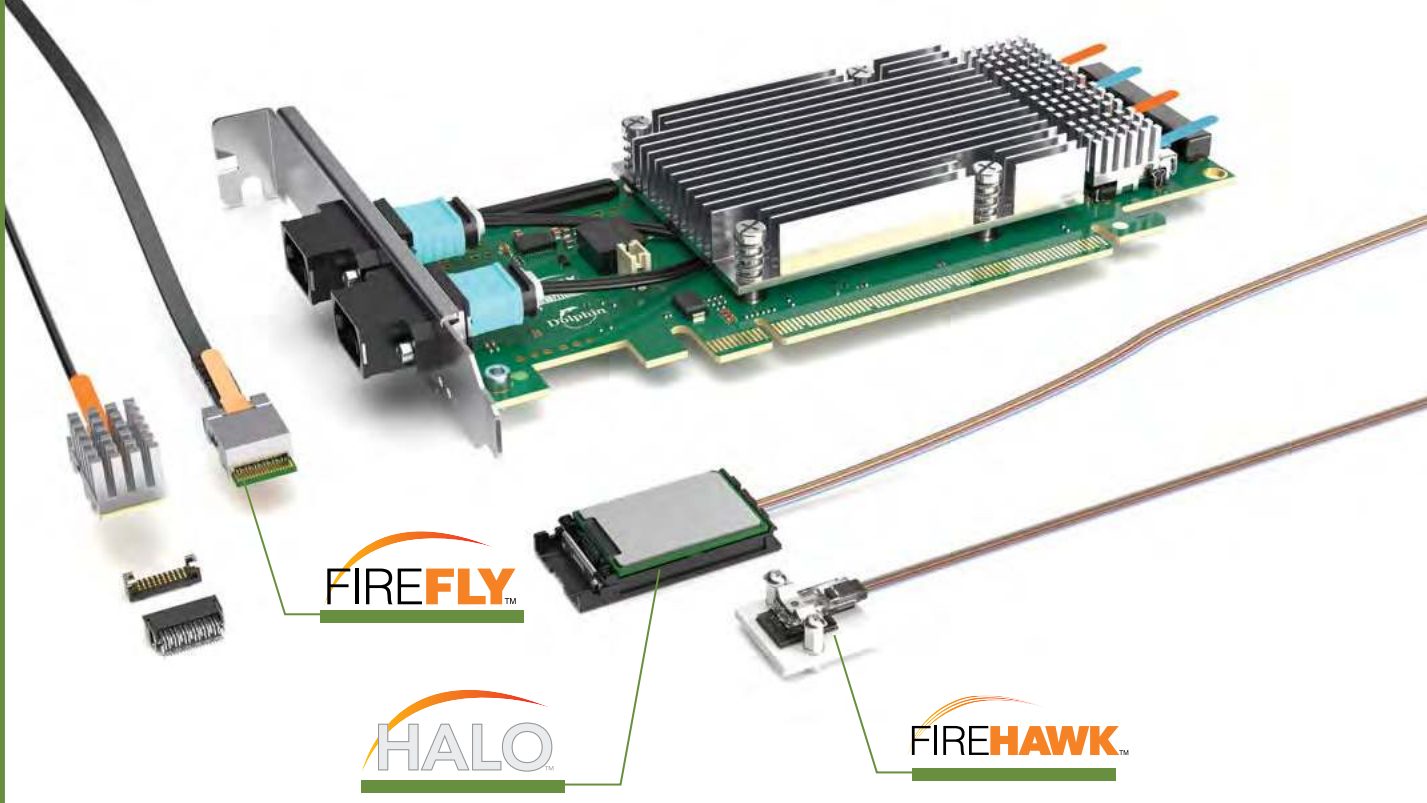

FIREFLY™

HALO

FIREHAWK™

RF

PRECISION RF | 50 Ω SOLUTIONS | 75 Ω SOLUTIONS | ORIGINAL SOLUTIONS

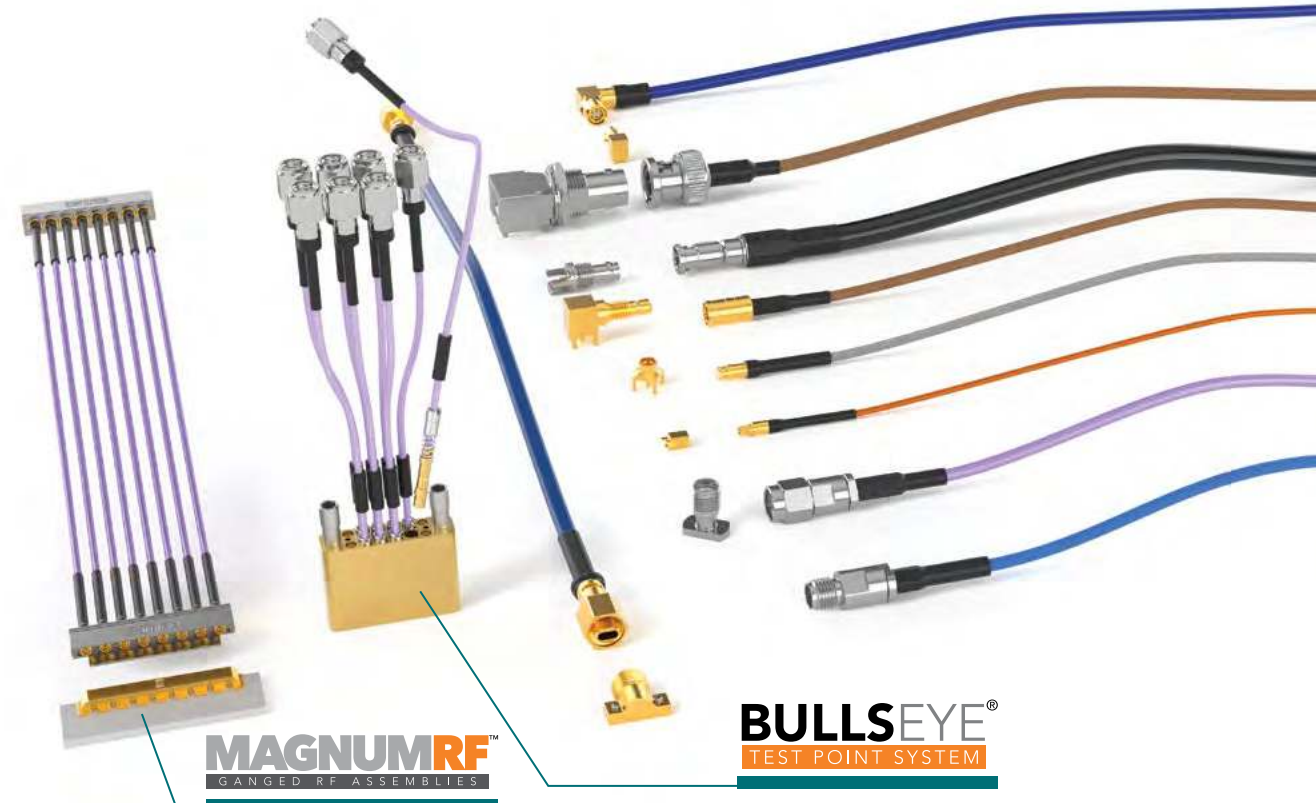

MAGNUMRF™
GANGED RF ASSEMBLIES

BULLSEYE®
TEST POINT SYSTEM

QUICK REFERENCE

Company, Product & Service Overview	2-7
Integration Leads to Innovation	8-9
Sudden Service®	10-11
Online Tools	12-13
Express Modifications & Engineered Customs	14
Flyover® Technology & Eye Speed® Cable	94-95
Testing (SET, E.L.P.™, DQT)	188-189
Power Services	190

Rugged Features & Contact Systems	327
Industry Standards	328-329
Evaluation & Development Kits	330-331
High-Speed Channel Performance Metric	332
General Specifications	333
Index by Brand	334
RF Product Index	335
Index by Series	336-337

HIGH-SPEED BOARD-TO-BOARD

High-Speed/High-Density Arrays

NovaRay® Extreme Density/Speed Arrays	16-17
AcceleRate® HP High-Performance Arrays	18-19
AcceleRate® HD Slim Body Arrays	20-21
AcceleRate® mP Signal/Power Arrays	22-23
SEARAY™ High-Density Arrays	24-27
SEARAY™ 0.80 mm Pitch Arrays	28-29
LP Array™ Low Profile Arrays	30-31
SUPERNOVA™ Low Profile Compression Interposers	32

High-Speed Mezzanine

Q Strip® Ground Plane Strips	36-39
Q2™ & Q Rate® Ground Plane Strips	40-42
High-Speed Signal & Power Combinations	43
Edge Rate® Contact Strips	46-52

Ultra Micro Interconnects

Razor Beam™ Hermaphroditic Strips	54-56
Micro Blade & Beam Strips	57-59

High-Speed Edge Card Connectors

0.60, 0.80 & 1.00 mm Pitch Generate™ Edge Cards	62-69
Micro & Mini Edge Cards	70-77
PCI Express® Edge Cards	78-80

High-Speed Backplane

NovaRay® Micro Rugged Backplane	82-83
ExaMAX® High-Speed Backplane	84-87
ExaMAX® Backplane Flyover® Cable Systems	88-89
XCede® HD High-Density Backplane	90-92

HIGH-SPEED CABLE

Flyover® Panel Assemblies

Flyover® QSFP Cable Systems	96-99
NovaRay® I/O Extreme Performance System	100-103
ExaMAX® I/O Shielded Cable System	104-105

Flyover® Mid-Board Cable Assemblies

NovaRay® Extreme Speed/Density System	108-109
AcceleRate® HP Extreme Density System	110-111
AcceleRate® Slim Cable System	112-113
AcceleRate® Mini Small Form Factor System	114-115
Si-Fly™ Low Profile Cable System	116-117
Generate™ Edge Card System	118

High-Speed Cable Assemblies

Micro Coax & Twinax Cable	120-121
SEARAY™ High-Density System	122-123
FireFly™ Copper Micro Flyover System™	124
PCI Express® 4.0 & 5.0 Systems	125-126
Generate™ High-Speed Test Cable	127
Additional High-Speed Cable Assemblies	128

OPTICS

Optical Systems

FireFly™ Optical Micro Flyover System™	130-136
FireHawk™ Rugged Optical Transceivers	138
Halo™ Next Gen Optics	139

RF

RF Systems

50 Ω Precision RF (18 GHz to 110 GHz)	144-167
Magnum RF™ Ganged Solutions	156-157
Bulls Eye® Test Point Systems	164-166
Flexible Waveguide Technology (E-band)	167
50 Ω and 75 Ω Solutions (3 GHz to 12 GHz)	168-181

RUGGED/POWER

Ultra Rugged

Ultra Rugged Systems & Roadmap	184-187
Ultra Rugged Testing (SET, E.L.P.™, DQT)	188-189

High Power

mPOWER® Ultra Micro Power Systems	192-197
PowerStrip™ Systems	198-207
Mini Mate® & Power Mate® Systems	208-210

Rugged I/O

URSA™ I/O Rugged Power Systems	212-215
AccliMate™ Sealed I/O Systems	216-218

Tiger Eye™ Board-to-Board

.050" Pitch Tiger Eye™ Systems	220-225
0.80 mm Pitch Tiger Eye™ Systems	226-227
2.00 mm Pitch Tiger Eye™ Systems	228-230

Discrete Wire

1.00 mm Pitch Micro Mate™ Systems	232-237
Tiger Eye™ Systems	238-242
Power Mate® & Mini Mate® Systems	243-245
PowerStrip™ Systems	246-248

FLEXIBLE STACKING

Board Stacking

Flexible Stacking	250-253
One-Piece Interfaces	254-255
0.50 mm, 0.635 mm, 0.80 mm Pitch Blade & Beam	256-261
0.80 mm & 1.00 mm Pitch Pin & Socket	262-266
.050" Pitch Strips	267-278
2.00 mm Pitch Headers & Stackers	279-286
2.00 mm Pitch Sockets & PC/104-Plus™	287-292
.025" (0.64 mm) SQ Post Headers, Stackers	293-303
.025" (0.64 mm) SQ Post Sockets & PC/104™	304-311

IDC/Flat Cable Systems

.100" Pitch IDC Systems	314-317
Tiger Eye™ IDC Systems	318-325
FFC Jumpers & Interfaces	326

INTEGRATION LEADS TO INNOVATION

Samtec's integrated approach provides high-level design and development of advanced interconnect systems and **TECHNOLOGIES**, along with industry-leading expertise that allows us to offer effective strategies and support for **optimizing the entire signal channel of high-performance systems.**

Samtec is structured like no other company in the interconnect industry. We work in a fully integrated capacity that enables true collaboration and results in uniquely innovative **PRODUCTS** because **our technology teams are not limited by the boundaries of traditional business units.**

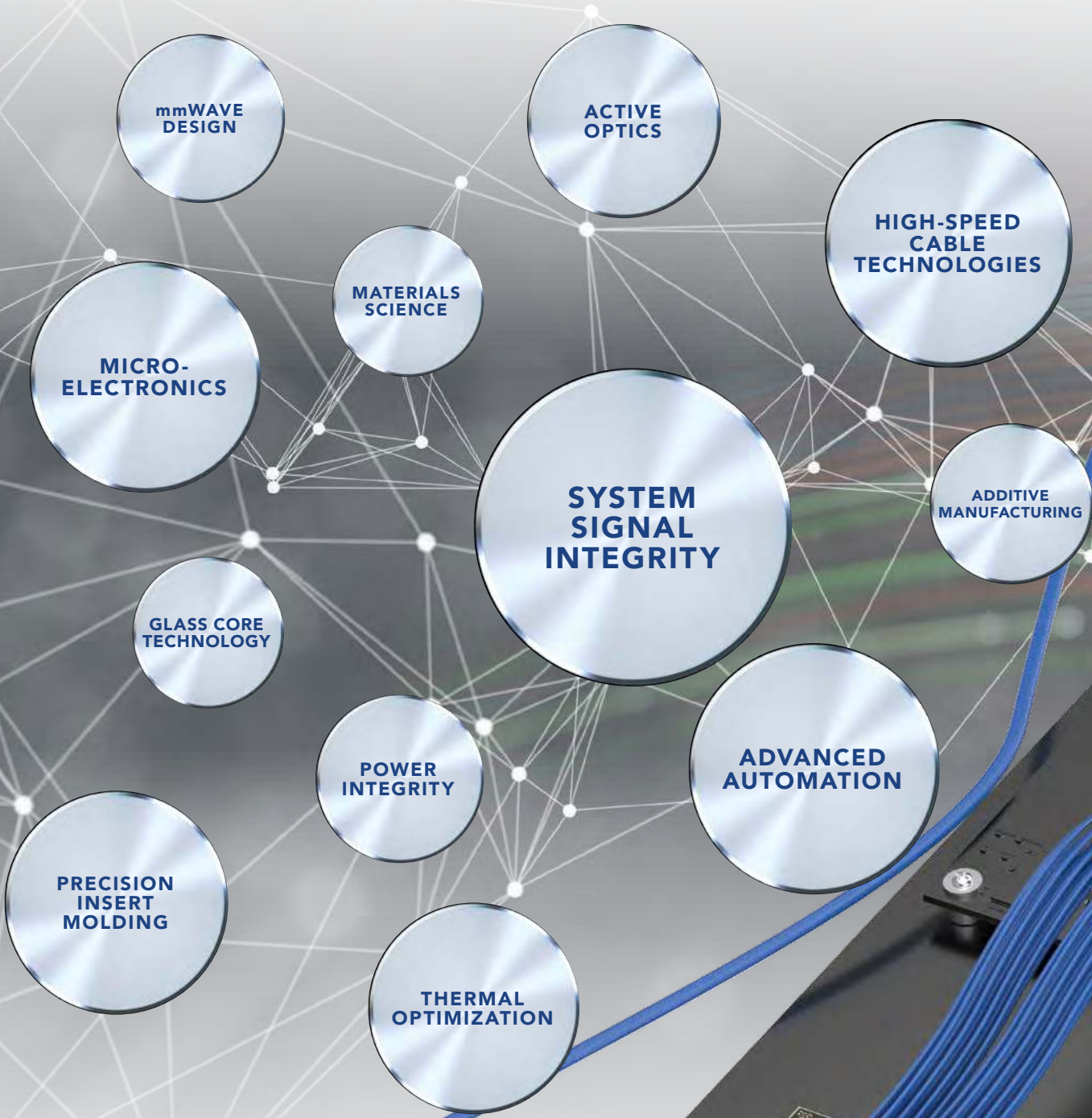

SILICON-TO-SILICON™ SOLUTIONS

As bandwidth, scale and power requirements continue to challenge conventional engineering methods, we want to help **optimize the landscape of your entire system** - and develop solutions, together.

Samtec's industry-leading signal integrity expertise, full system optimization strategies and, innovative products and technologies help address the challenges of next gen data transmission for **a path to 224 Gbps and beyond**.

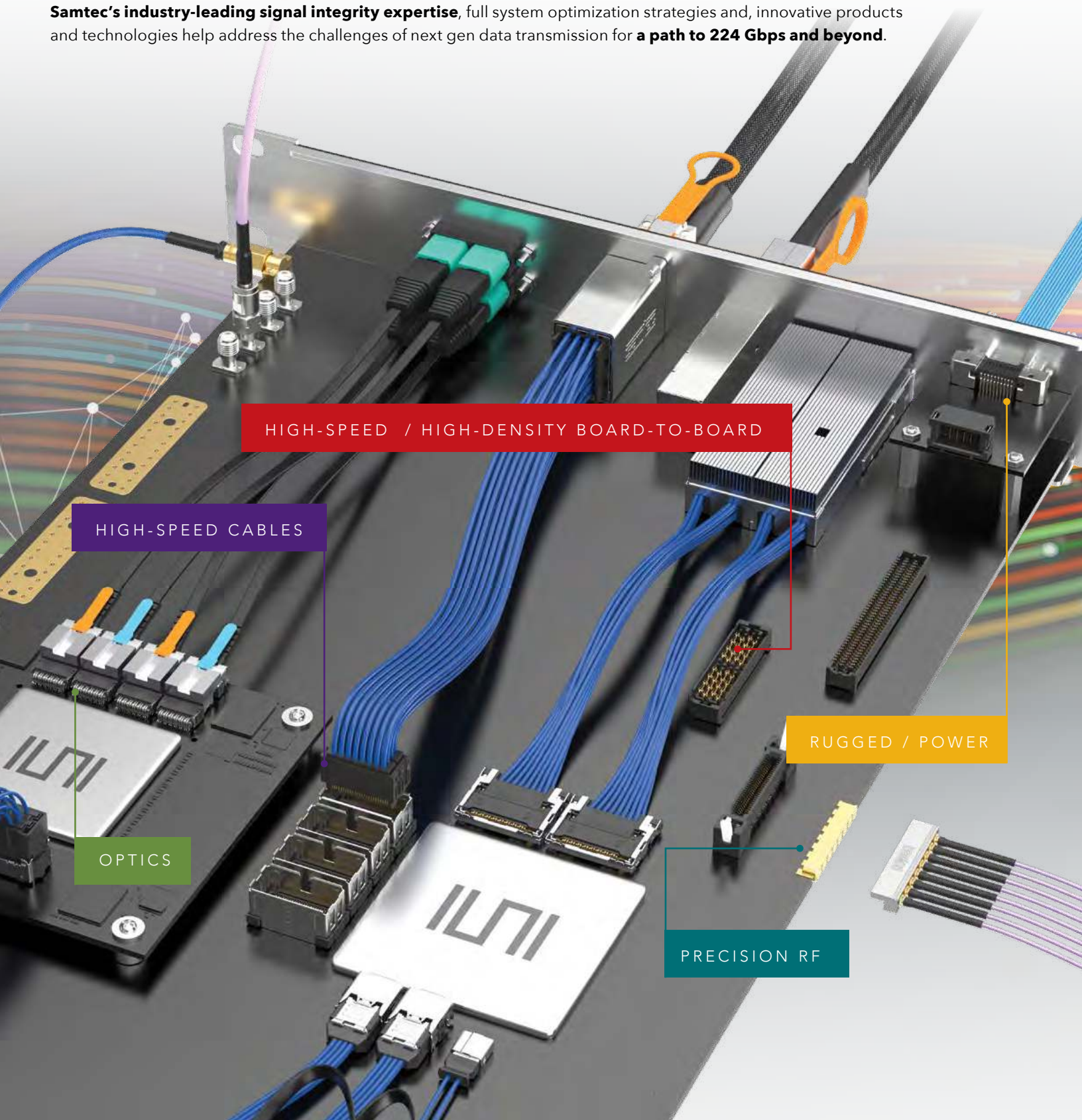

HIGH-SPEED / HIGH-DENSITY BOARD-TO-BOARD

HIGH-SPEED CABLES

RUGGED / POWER

OPTICS

PRECISION RF

SUDDEN SERVICE®

Samtec's Sudden Service® provides unmatched global service, free access to data and industry leading tools, along with engineering support, to help you design, develop, test and deliver the best solution for any complex application.

GLOBAL OPERATIONS & SUPPORT NETWORK



AWARD-WINNING SERVICE

#1 in Bishop's Customer Survey of the Electronic Connector Industry.



Samtec has been consistently rated as the #1 connector company in North America, Europe and Asia. This is the highest overall rating in the Bishop & Associates' U.S., Europe and Asia Customer Surveys of the Electronic Connector Industry.

UNMATCHED LEAD-TIMES

Innovative Programs & Systems Enable Deliveries in Days, Not Weeks.

Reserve™

SHIPS TOMORROW

This designation allows customers to **quickly and easily identify availability of over 200,000 of Samtec's most popular connectors and cables - guaranteed to ship in 1-day.**

Look for the **Reserve** badge throughout **samtec.com** to quickly determine if your part number is eligible, along with current availability, quantity breaks and pricing. Hundreds of part numbers are being added daily!

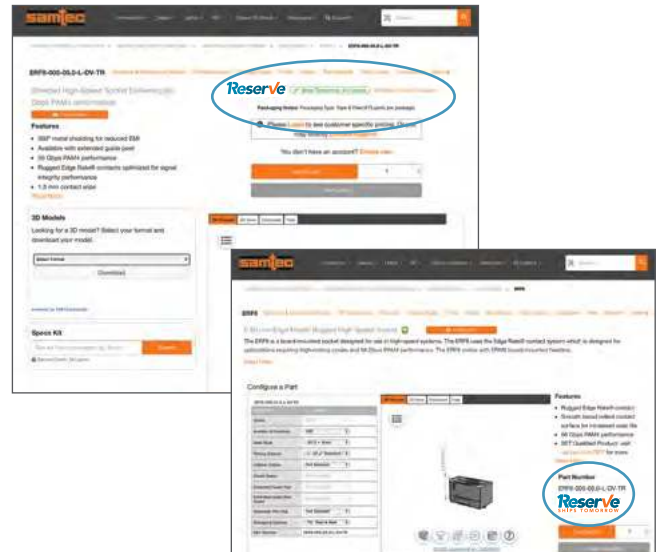

Free product samples, shipped in 24-hours or less have been a cornerstone of Samtec Sudden Service® since the company was founded. Visit **samtec.com** to quickly request your sample.

An innovative shipping program that **bridges the gap between manufacturing facilities and customers**, allowing for manufacturing flexibility without increased costs, and with even faster lead-times. Contact **ecustomerservice@samtec.com** to learn more.

24/7 WORLDWIDE ACCESS

Samtec is the Electronics Industry's Service & Technology Leader.

Technical Support

Signal Integrity Group: sig@samtec.com

Application Support Group: asg@samtec.com

Interconnect Processing Group: ipg@samtec.com

Supply Chain Support

MySamtec™ Real-Time Account Access: account.samtec.com

Personal Account Managers & CSRs: ecustomerservice@samtec.com

Upfront, Aggressive 24-Hour Quotes: pricing@samtec.com

ONLINE TOOLS

Find, Design & Validate Your Solution

PICTURE SEARCH



Browse through a highlight reel of Samtec's most popular products to find the ideal solution for your application, view specifications, check availability, order samples and more. Visit samtec.com/picturesearch.



SOLUTIONATOR®

Quickly build mated connector sets or design full cable assemblies using a wide variety of user-defined search parameters and filters, view specs and order samples.

Solutionator **HS** GET A MATED SET IN SECONDS TO-BOARD



samtec.com/hs2b-solutionator

Solutionator **HS** DESIGN IN A MINUTE CABLE



samtec.com/cablebuilder

Solutionator **RF** DESIGN IN A MINUTE CABLE



samtec.com/rf-cablebuilder

Solutionator **FLEX** GET A MATED SET IN SECONDS STACKING



samtec.com/flex-solutionator

Solutionator **ACTIVE** DESIGN IN A MINUTE OPTICS



samtec.com/optics-solutionator

Solutionator **DISCRETE** DESIGN IN A MINUTE WIRE



samtec.com/dw-cablebuilder

Samtec is committed to the continuous evolution of our award-winning website, providing customers with innovative design tools, technical resources and support needed to make **finding, designing and ordering** the right product as easy and streamlined as possible.

DOWNLOADS

3D Models, Specs, Prints & More

3D Models

Quickly configure, preview and download models in more than 150 different formats, including AutoCad, Solid Edge, Inventor and many more.



Test Reports

Samtec provides immediate access to a variety of testing and qualification reports for our products, including high-speed characterization, thermal, frequency and time domain, Extended Life Product™, Severe Environment Testing, and others.

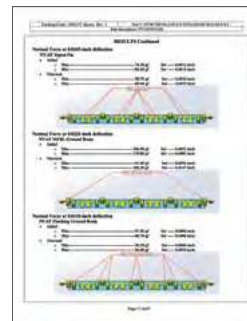

PCB Footprint / eCAD Models

Instantly view, download and design with over 200,000 ready-to-use eCAD models.

These detailed models have been formatted to work with leading schematic captures and include accurate assembly, silkscreen and 3D features.



Technical Library

Samtec's online Technical Library contains a wealth of resources, including Prints & Specifications, White Papers, Application Notes, Test Reports, Product Videos, Design Guides, Processing Information and much more.

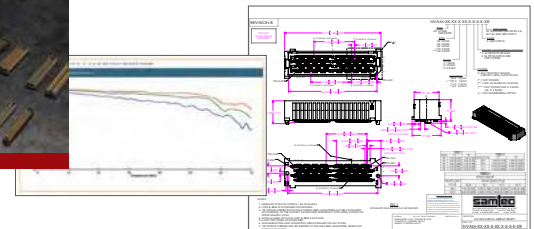

mySamtecTM
account.samtec.com

Samtec's user-friendly eCommerce platform allows you to quickly and easily check product availability and pricing, as well as place and manage your orders online.

MODIFIED & CUSTOM SOLUTIONS



With dedicated Application Specific Product engineers and technicians, Samtec is open to customizing interconnects spanning every product category we offer, which includes both simple modifications as well as completely new and custom designs.

INDUSTRY-LEADING SUPPORT & EXPERTISE

Visit [samtec.com/custom](https://www.samtec.com/custom) for details.

- Full engineering, design and prototype support
- Design, simulation and processing assistance
- Dedicated Application Specific Product engineers and technicians
- Industry-leading Customer Service
- Quotes and samples turned around in 24 hours
- Flexible, quick-turn in-house manufacturing
- Customer specific testing - AS9102 FAIs available
- ITAR compliant with U.S. based manufacturing
- Contact the Application Specific Products Group at asp@samtec.com to discuss your application

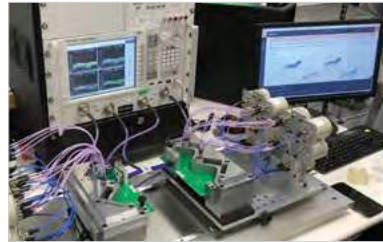
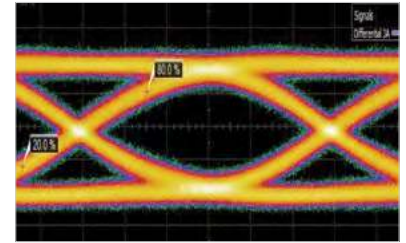

EXPRESS MODIFICATIONS & ENGINEERED CUSTOMS

- Up to 50 μ " Gold and Tin Lead plating available
- Polarized positions
- Modified stack heights, latching and screw downs
- Modified contacts, bodies, stamping, plating, wiring, molding and much more
- Ruggedizing features including strain relief, plastic housings, screw downs, latches, locks, etc.
- Mix-and-match cable end options for application specific requirements
- Many non-cataloged cable standards available, including 75 Ω micro coax & high-density twinax solutions
- Solutions for Optics in extreme environments: Samtec MIL-coat protected, salt-fog impenetrable, mitigation for tin whiskers, fungal resistant, extreme shock and vibration, full support for liquid immersion cooling



HIGH-SPEED HIGH-DENSITY ARRAYS

EXTREME DENSITY • HIGH-PERFORMANCE • MAXIMUM DESIGN FLEXIBILITY

16-17

NOVARAY® EXTREME
PERFORMANCE ARRAYS
(NVAM, NVAF)



NOVARAY

18-19

ACCELERATE® HP
HIGH-PERFORMANCE
ARRAYS (APM6, APF6)



ACCELERATE®HP

20-21

ACCELERATE® HD
HIGH-DENSITY
ARRAYS (ADM6, ADF6)

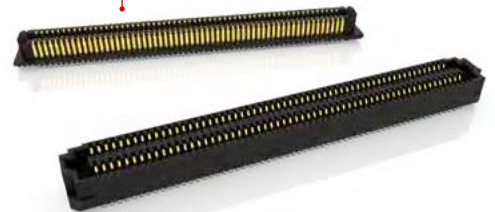

ACCELERATE®HD

22-23

ACCELERATE® MP
POWER/SIGNAL ARRAYS
(UDM6/UDF6)

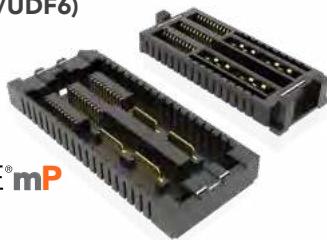

ACCELERATE®mP

24-27

SEARAY™ 1.27 mm PITCH
OPEN-PIN-FIELD ARRAYS
(SEAF, SEAM)



SEARAY™

28-29

SEARAY™ 0.80 mm PITCH
OPEN-PIN-FIELD ARRAYS
(SEAM8, SEAF8)



SEARAY™.8mm

30-31

LP ARRAY™
LOW PROFILE ARRAYS
(LPAM, LPAF)



LPARRAY™

32

SUPERNOVA™
LOW PROFILE
COMPRESSION
INTERPOSERS (GMI)



EXTREME PERFORMANCE HIGH-DENSITY ARRAYS

(0.80 mm) .0315" x (1.80 mm) .071" PITCH



FEATURES & BENEFITS

- 112 Gbps PAM4 per channel
- 48 fully shielded differential pairs per square inch
- 4.0 Tbps aggregate data rate - 9 IEEE, 400G channels
- Extremely low crosstalk beyond 40 GHz
- Incredibly tight impedance control
- Minimal variance in data rate as stack height increases
- Utilizes 40% less space with the same data throughput as compared to traditional arrays

NRZ	PAM4
56 Gbps	112 Gbps



High-speed mezzanine connector and cable in one product family



BGA attach to board for greater density and optimized trace breakout region



Two reliable points of contact with a 1.14 mm wipe

KEY SPECIFICATIONS (NVAM/NVAF)

TOTAL PAIRS	INSULATOR MATERIAL	CONTACT MATERIAL	PLATING	OPERATING TEMP RANGE	CURRENT RATING	WORKING VOLTAGE	LEAD-FREE SOLDERABLE
Up to 32 pairs	Black LCP	Copper Alloy	Au or Sn over 50 μ" (1.27 μm) Ni	-55 °C to +125 °C	2.1 A per pin (signal) 9.6 A per pin (ground)	200 VAC	Yes

0.80 mm x 1.80 mm PITCH • EXTREME PERFORMANCE ARRAYS

SERIES	STYLE	NO. OF ROWS	NO. OF BANKS	LEAD STYLE	PLATING OPTION	SOLDER TYPE	K	"X"R
NVAM Terminal	-DP = 4 pairs per wafer	-02	-1 = 1 Bank	-02.0 = (2 mm) .0787" (NVAM only)	-S = 30 μm (0.76 μm) Gold on contact area, Matte Tin on solder tail	-2 = Lead-Free Solder Charge	-K = (3.50 mm) .138" DIA Polyimide film Pick & Place Pad	-TR = Tape & Reel
NVAF Socket		-03		-05.0 = (5 mm) .1969"				-FR = Full Reel Tape & Reel (must order maximum quantity per reel; contact Samtec for quantity breaks)
	-04	-07.0 = (7 mm) .2756" (NVAF only)						

NVAM
Board Mates:
NVAF
Standoffs:
GPSO

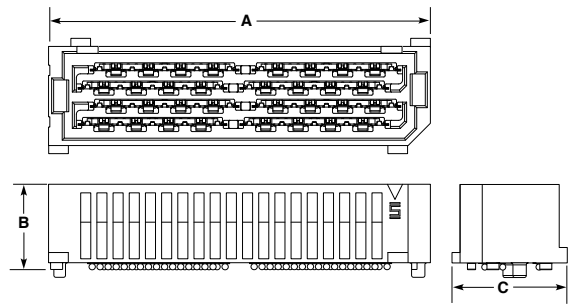

NO. OF BANKS	A	LEAD STYLE	B	NO. OF ROWS	C
-1	(21.75) .856	-02.0	(5.46) .215	-02	(7.80) .307
-2	(37.75) 1.486	-05.0	(8.46) .333	-03	(9.60) .378
				-04	(11.40) .449

View complete specifications at: samtec.com?NVAM

NVAF
Board Mates:
NVAM
Standoffs:
GPSO

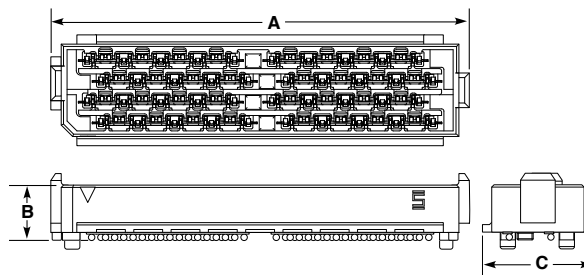

NO. OF BANKS	A
-1	(20.25) .797
-2	(36.25) 1.427

LEAD STYLE	B
-05.0	(4.80) .189
-07.0	(6.80) .268

NO. OF ROWS	C
-02	(6.00) .236
-03	(7.80) .307
-04	(9.60) .378

MATED HEIGHTS*		
NVAF LEAD STYLE	NVAM LEAD STYLE	
	-02.0	-05.0
-05.0	(7.00) .276	(10.00) .394
-07.0	(9.00) .354	(12.00) .472

AGGREGATE DATA RATE (NRZ)				
448 Gbps	672 Gbps	896 Gbps	1344 Gbps	1792 Gbps
1 Bank		2 Bank		
2 Row	3 Row	4 Row 2 Row	3 Row	4 Row
8 Pairs	12 Pairs	16 Pairs	24 Pairs	32 Pairs

*Processing conditions will affect mated height.

Notes:
Some sizes, styles and options are non-standard, non-returnable

View complete specifications at: samtec.com?NVAF

ACCELERATE[®]HP

HIGH-PERFORMANCE ARRAY SYSTEM

(0.635 mm) .025" PITCH

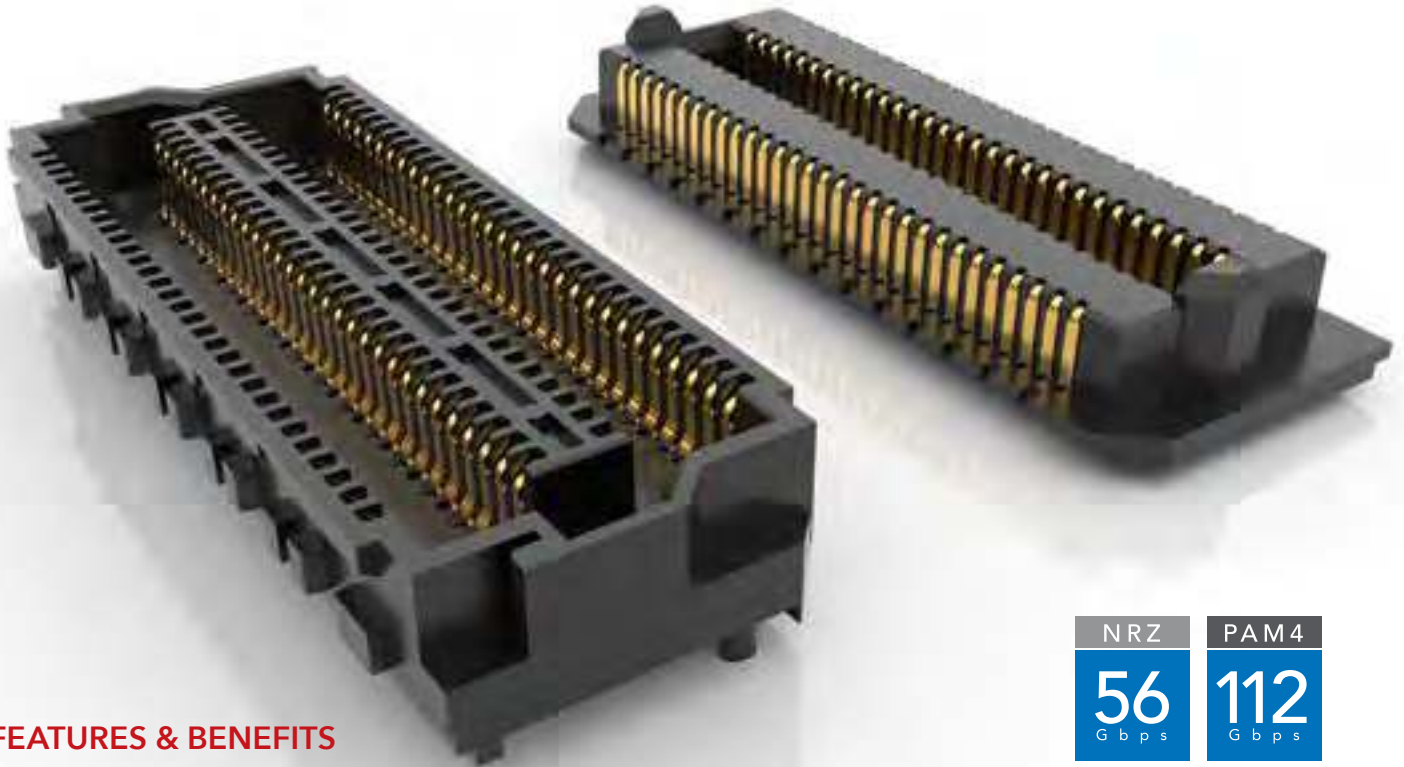

FEATURES & BENEFITS

- Flexible open-pin-field and cost optimized, extreme performance solution
- Low profile 5 mm and up to 10 mm stack heights
- 0.635 mm pitch
- Four row design with up to 400 total pins; roadmap to 1,000+ pins
- Data rate compatible with PCIe[®] 6.0 and 100 GbE
- In Development: 6, 8 and 10 rows, additional position counts

NRZ	PAM4
56 G b p s	112 G b p s



Right-angle connector
(samtec.com?APF6-RA)

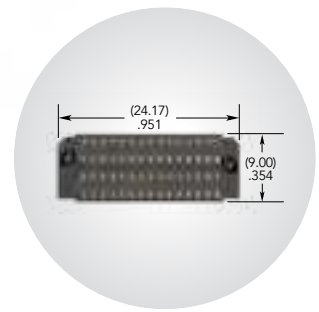

APF6 Series; 120 pins

KEY SPECIFICATIONS (APM6/APF6)

TOTAL PINS	INSULATOR MATERIAL	CONTACT MATERIAL	PLATING	OPERATING TEMP RANGE	CURRENT RATING	VOLTAGE RATING	LEAD-FREE SOLDERABLE
40 - 400	Black LCP	Copper Alloy	Au or Sn over 50 μ" (1.27 μm) Ni	-55 °C to +125 °C	1.2 A (4 pins powered)	150 VAC	Yes

(0.635 mm) .025" PITCH • 112 Gbps PAM4 OPEN-PIN-FIELD ARRAYS

SERIES	NO. OF POSITIONS	LEAD STYLE	PLATING OPTION	NO. OF ROWS	0	OPTION	"X"R
APM6 Terminal	-020, -040, -060, -100 (per row)	-01.5 = 1.5 mm (APM6 only)	-L = 10 μ" (0.25 μm) Gold on contact area, Matte Tin on tail	-04 = Four Rows		(Leave blank for no alignment pin)	-TR = Tape & Reel
APF6 Socket	-064 (per row) (APM6 & -01.9 lead style only)	-01.9 = 1.9 mm (APM6-064 only)	-S = 30 μ" (0.76 μm) Gold on contact area, Matte Tin on tail			-A = Alignment Pin	-FR = Full Reel Tape & Reel (must order max. quantity per reel; contact Samtec for quantity breaks)
		-06.5 = 6.5 mm (APM6 only)					
		-03.5 = 3.5 mm (APF6 only)					

APM6
Board Mates:
APF6, APF6-RA

Standoffs:
GPSO

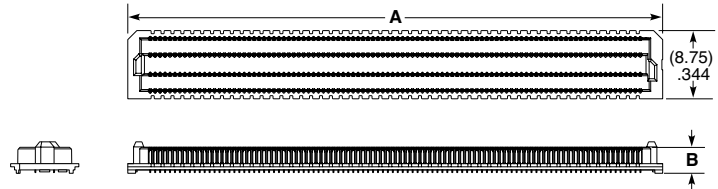

NO. OF POSITIONS PER ROW	A	LEAD STYLE	B
-020	(17.82) .701	-01.5	(3.33) .131
-040	(30.52) 1.201	-01.9	(3.71) .146
-060	(43.22) 1.701	-06.5	(8.33) .328
-064	(45.21) 1.780		
-100	(68.62) 2.701		

View complete specifications at: samtec.com?APM6

MATED HEIGHTS *		
APF6 LEAD STYLE	APM6 LEAD STYLE	
	-01.5	-06.5
-03.5	(5.00 mm) .197"	(10.00 mm) .394"

* Processing conditions will affect mated height.

APF6
Board Mates:
APM6

Standoffs:
GPSO

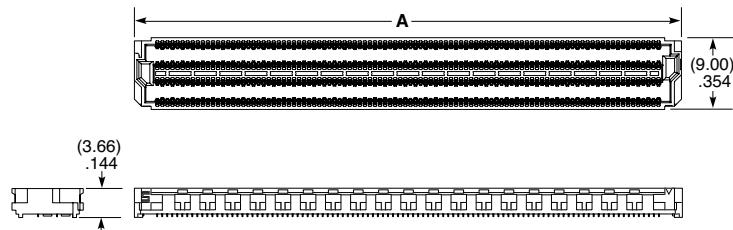

ALSO AVAILABLE

Right-angle
samtec.com?APF6-RA

Notes:
Some sizes, styles and options are non-standard, non-returnable

View complete specifications at: samtec.com?APF6

NO. OF POSITIONS PER ROW	A
-020	(17.82) .701
-040	(30.52) 1.201
-060	(43.22) 1.701
-100	(68.62) 2.701

ACCELERATE[®] HD

HIGH-DENSITY SLIM BODY ARRAYS

(0.635 mm) .025" PITCH



FEATURES & BENEFITS

- Up to 400 positions in a 4-row design
- 5 mm, 7 mm, 9 mm, 10 mm, 11 mm, 12 mm, 14 mm & 16 mm stack heights
- Slim 5 mm width body design
- Edge Rate[®] contact system optimized for signal integrity performance
- Open-pin-field for grounding and routing flexibility
- Supports 64 Gbps PAM4 (32 Gbps NRZ) applications
- PCIe[®] 6.0 capable

PAM4

64
Gbps



SureWare[™] ultra rugged guide post standoffs available (GPSO)

HIGHER DENSITY THAN PREVIOUS GENERATION STRIPS

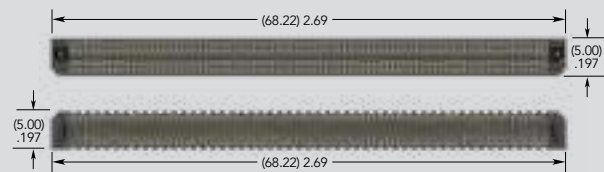

ADM6/ADF6 Series (400 total positions)

KEY SPECIFICATIONS (ADM6/ADF6)

PITCH	TOTAL POSITIONS	INSULATOR MATERIAL	CONTACT MATERIAL	PLATING	OPERATING TEMP RANGE	CURRENT RATING	WORKING VOLTAGE	LEAD-FREE SOLDERABLE
(0.635 mm) .025"	40 - 400	Black LCP	Copper Alloy	Au or Sn over 50 μ" (1.27 μm) Ni	-55 °C to +125 °C	1.4 A per pin (4 pins powered)	155 VAC	Yes

(0.635 mm) .025" PITCH • SLIM BODY OPEN-PIN-FIELD ARRAYS

SERIES	NO. OF POSITIONS	LEAD STYLE	PLATING OPTION	NO. OF ROWS	0	OPTION	"X"R
ADM6 Terminal	-10, -20, -30, -40, -50, -60, (per row)	-01.5 = 1.5 mm (ADM6 only)	-L = 10 μ" (0.25 μm) Gold on contact area, Matte Tin on tail	-4 = Four Rows		(Leave blank for no alignment pin)	-TR = Tape & Reel
ADF6 Socket	-70, -80, -90, -100 (ADM6-03.5 & ADM6-01.5 lead styles only)	-03.5 = 3.5 mm	-S = 30 μ" (0.76 μm) Gold on contact area, Matte Tin on tail			-A = Alignment Pin	-FR = Full Reel Tape & Reel (must order max. quantity per reel; contact Samtec for quantity breaks)
		-06.5 = 6.5 mm (ADM6 only)	-STL = 30 μ" (0.76 μm) Gold on contact area, Tin/Lead on solder tail (ADM6 -01.5 lead style & ADF6 -03.5 lead style only)				
		-07.5 = 7.5 mm (ADF6 only)					
		-08.5 = 8.5 mm (ADM6 only)					

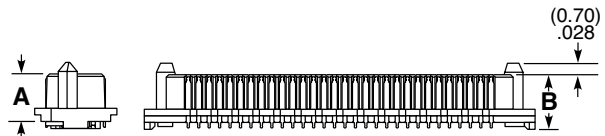
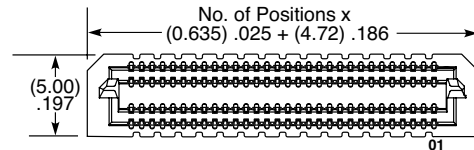

ADM6

Board Mates:
ADF6

Standoffs:
JSO, GPSO



LEAD STYLE	A	B
-01.5	(2.90) .114	(3.32) .131
-03.5	(4.90) .193	(5.32) .209
-06.5	(7.90) .311	(8.32) .328
-08.5	(9.90) .390	(10.32) .406

View complete specifications at: samtec.com?ADM6

MATED HEIGHTS *

ADF6 LEAD STYLE	ADM6 LEAD STYLE			
	-01.5	-03.5	-06.5	-08.5
-03.5	(5 mm) .197"	(7 mm) .276"	(10 mm) .394"	(12 mm) .472"
-07.5	(9 mm) .354"	(11 mm) .433"	(14 mm) .551"	(16 mm) .630"

* Processing conditions will affect mated height.

ADF6

Board Mates:
ADM6

Standoffs:
JSO, GPSO

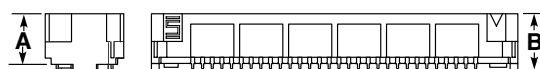
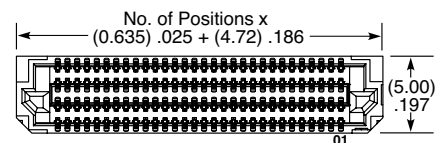

LEAD STYLE	A	B
-03.5	(3.23) .127	(3.65) .144
-07.5	(7.23) .285	(7.65) .301

Notes:

Some sizes, styles and options are non-standard, non-returnable

View complete specifications at: samtec.com?ADF6

ACCELERATE[®]mP

HIGH-DENSITY, HIGH-SPEED POWER/SIGNAL ARRAYS

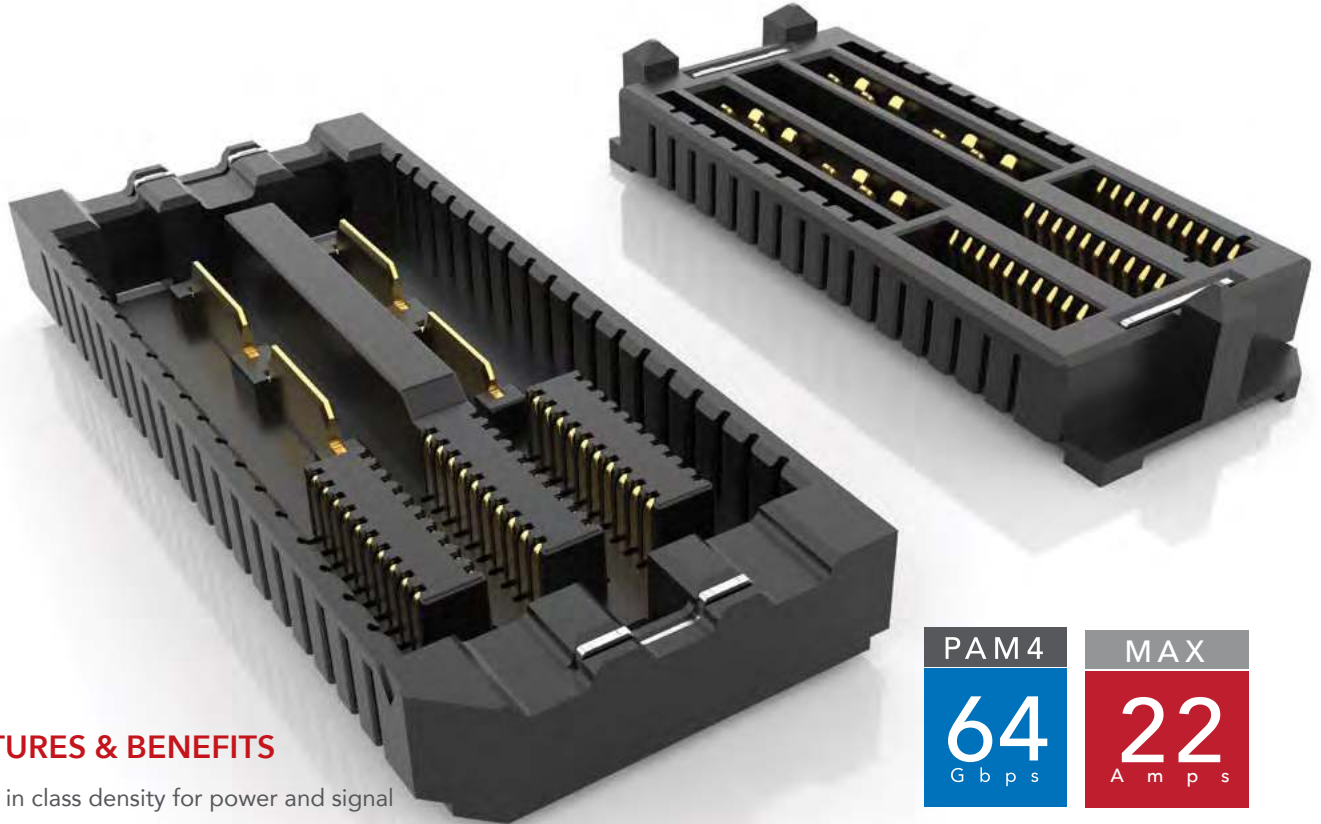

PAM4	MAX
64 Gbps	22 Amps

FEATURES & BENEFITS

- Best in class density for power and signal
- Rotated power blades improve performance and simplify breakout region (BOR)
- Open-pin-field design for routing and grounding flexibility
- Low profile 5 mm stack height; up to 16 mm in development
- Up to 8 power and 240 signal positions; additional position counts in development
- 0.635 mm signal pitch
- Supports 64 Gbps PAM4 (32 Gbps NRZ) applications
- PCIe[®] 6.0 capable
- Optional alignment pins and weld tabs for a secure connection to the board
- Polarized guide posts for blind mating

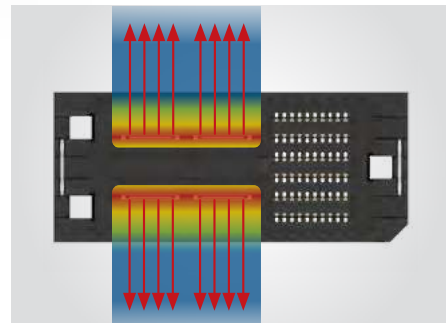

Blades rotated 90° have equal access to heat escape for uniform cooling, increased current capacity and reduced crowding

KEY SPECIFICATIONS (UDM6/UDF6)

PITCH	STACK HEIGHTS	INSULATOR MATERIAL	CONTACT MATERIAL	PLATING	OPERATING TEMP RANGE	CURRENT RATING	VOLTAGE RATING	LEAD-FREE SOLDERABLE
0.635 mm (Signal) 6.00 mm (Power)	5 mm	Black LCP	Copper Alloy	Au or Sn over 50 μ" (1.27 μm) Ni	Testing Now!	Testing Now!	Testing Now!	Yes

(0.635 mm) .025" PITCH • UDM6/UDF6 SERIES

UDM6	NO. OF SIGNAL POSITIONS	NO. OF POWER POSITIONS	LEAD STYLE	PLATING OPTION	OPTION	WELD TAB	"X"R
	-10, -40 (Per Row)	-2, -4 (Per Row)	-01.5 = 1.5 mm	-L = 10 μ" (0.25 μm) Gold on contact area, Matte Tin on tail -S = 30 μ" (0.76 μm) Gold on contact area, Matte Tin on tail -STL = 30 μ" (0.76 μm) Gold on contact area, Tin/Lead on solder tail	(Leave blank for no alignment pin) -A = Alignment Pin	-TH = Through-Hole	-TR = Tape & Reel -FR = Full Reel Tape & Reel (must order max. quantity per reel; contact Samtec for quantity breaks)

PRELIMINARY

UDM6

Board Mates:
UDF6

Standoffs:
GPSO

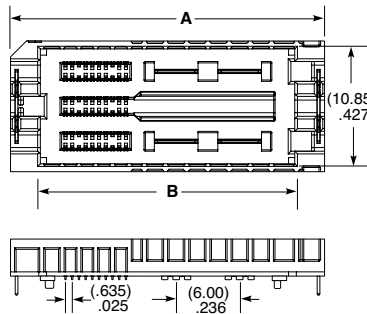

NO. OF SIGNAL PER ROW	NO. OF POWER PER ROW	A	B
-010	-2	(29.68) 1.168	(24.42) .961
-040	-4	(60.73) 2.391	(55.47) 2.184

UDM6-10-2-01.5-X-A-TH-XR
(Some center features removed for clarity)

Notes:
Some sizes, styles and options are non-standard, non-returnable

View complete specifications at: samtec.com?UDM6

UDF6	NO. OF SIGNAL POSITIONS	NO. OF POWER POSITIONS	LEAD STYLE	PLATING OPTION	OPTION	WELD TAB	"X"R
	-10, -40 (Per Row)	-2, -4 (Per Row)	-03.5 = 3.5 mm	-L = 10 μ" (0.25 μm) Gold on contact area, Matte Tin on tail -S = 30 μ" (0.76 μm) Gold on contact area, Matte Tin on tail -STL = 30 μ" (0.76 μm) Gold on contact area, Tin/Lead on solder tail	(Leave blank for no alignment pin) -A = Alignment Pin	-TH = Through-Hole	-TR = Tape & Reel -FR = Full Reel Tape & Reel (must order max. quantity per reel; contact Samtec for quantity breaks)

PRELIMINARY

UDF6

Board Mates:
UDM6

Standoffs:
GPSO



NO. OF SIGNAL PER ROW	NO. OF POWER PER ROW	A	B
-010	-2	(26.88) 1.058	(23.90) .941
-040	-4	(57.93) 2.281	(54.95) 2.163

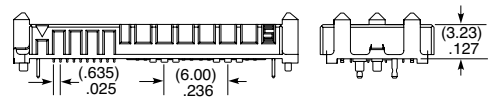
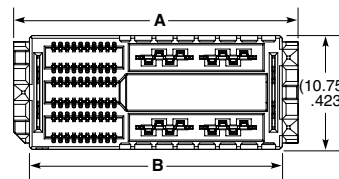

UDF6-10-2-03.5-X-A-TH-XR
(Some center features removed for clarity)

Notes:
Some sizes, styles and options are non-standard, non-returnable

View complete specifications at: samtec.com?UDF6



HIGH-DENSITY OPEN-PIN-FIELD ARRAYS

(1.27 mm) .050" PITCH

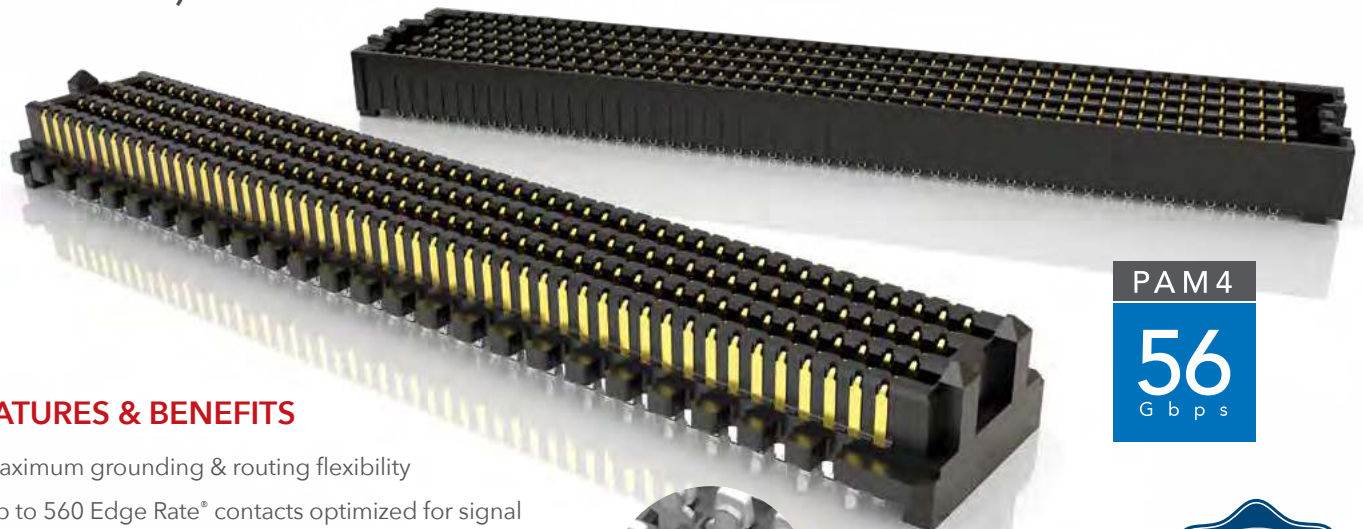

FEATURES & BENEFITS

- Maximum grounding & routing flexibility
- Up to 560 Edge Rate® contacts optimized for signal integrity performance.
- 7 mm to 40 mm stack heights
- Variety of designs and options: Right-Angle, Guide Posts, 85 Ω Elevated Risers, 85 Ω Tuned, Press-Fit and Press-Fit Right-Angle, Guide Post Field Termination Kits
- Cable mates (SEAC Series) and Jack Screw Standoffs (JSO Series) also available
- Standards: VITA 47, VITA 57.1 FMC, VITA 57.4 FMC+, VITA 74 VNX, PISMO™ 2
- Supports high-speed protocols such as Ethernet, PCI Express®, Fibre Channel & InfiniBand™
- Severe Environment Testing qualified (SEAM/SEAF); aligns with MIL-DTL-55302. Visit samtec.com/set



Solder Charges

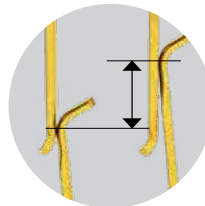

(1.12 mm) .044" Nominal Wipe

EDGE RATE
CONTACT

PAM 4
56
G b p s



MAXIMUM GROUNDING & ROUTING FLEXIBILITY

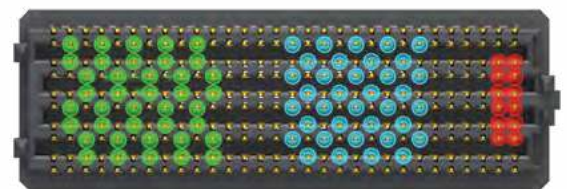

Differential Pair Single-Ended Power

SERIES	INSULATOR MATERIAL	CONTACT MATERIAL	PLATING	OPERATING TEMP RANGE	CURRENT RATING	VOLTAGE RATING	LEAD-FREE SOLDERABLE
SEAM/SEAF	Black LCP	Copper Alloy	Au or Sn over 50 μ" (1.27 μm) Ni	-55 °C to +125 °C	2.7 A (10 pins powered)	240 VAC	Yes
SEAM-RA/SEAF-RA	Black LCP	Copper Alloy	Au or Sn over 50 μ" (1.27 μm) Ni	-55 °C to +125 °C	1.9 A (10 pins powered)	260 VAC	Yes
SEAM-GP	Black LCP	Copper Alloy	Au or Sn over 50 μ" (1.27 μm) Ni	-55 °C to +125 °C	2.7 A (10 pins powered)	240 VAC	Yes
SEAMP/SEAFP	Natural High Temp Nylon	Copper Alloy (SEAMP) BeCu Alloy (SEAFP)	Au or Sn over 50 μ" (1.27 μm) Ni	-55 °C to +125 °C	1.9 A (6 pins powered)	225 VAC	Not Available
SEAR	Black LCP	Hard Gold Plated	Au over 50 μ" (1.27 μm) Ni	-55 °C to +125 °C	Contact Samtec	240 VAC	Not Available
SEAMI	Black LCP	Copper Alloy	Au or Sn over 50 μ" (1.27 μm) Ni	-55 °C to +125 °C	Not Available	Not Available	Yes

Note: Some lengths, styles and options are non-standard, non-returnable

(1.27 mm) .050" PITCH • SEAM/SEAF SERIES

SERIES	POSITIONS PER ROW	LEAD STYLE	PLATING OPTION	NO. OF ROWS	SOLDER TYPE	A	K	"X" R
SEAM Terminal	-10, -15, -20, -30, -40, -50	Specify LEAD STYLE from chart	-L = 10 μ" (0.25 μm) Gold on contact area, Matte Tin on solder tail	-04	-1 = Tin/Lead Alloy Solder Charge	-A = Alignment Pin	-K Polyimide Film Pick & Place Pad	"X" R = Full Reel Tape & Reel (must order max. quantity per reel; contact Samtec for quantity breaks)
SEAF Socket	SEAM & SEAF: -10 only available in -04 Row SEAM: -15 only available in -04 Row with -02.0 Lead Style, and -10 Row with any Lead Style SEAF: -15 only available in -04 or -10 Row with -5.0 Lead Style		-S = 30 μ" (0.76 μm) Gold on contact area, Matte Tin on solder tail	-05 -06 -08 -10	-2 = Lead-Free Solder Charge			
			-STL = 30 μ" (0.76 μm) Gold on contact area, Tin/Lead on solder tail	(SEAM -04, -05 & -06 Rows not available with -06.5 Lead Style)				

SEAM

Board Mates: SEAF, SEAFP
Standoffs: JSO

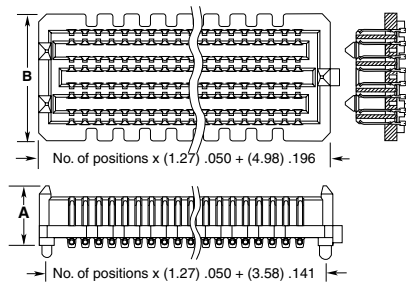
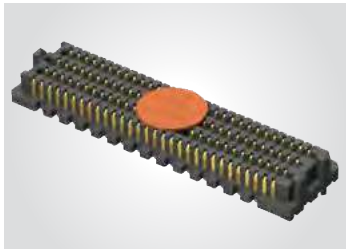

LEAD STYLE	A	NO. OF ROWS	B
-02.0	(5.61) .221	-04	(7.06) .278
-03.0	(6.60) .260	-05, -06	(9.60) .378
-03.5	(7.11) .280	-08	(12.14) .478
-06.5	(10.16) .400	-10	(14.68) .578
-07.0	(10.59) .417		
-09.0	(12.60) .496		
-11.0	(14.61) .575		

View complete specifications at: samtec.com?SEAM

ALSO AVAILABLE
See website for 14 row option.

SEAF

Board Mates: SEAM, SEAMP, SEAR, SEAMI
Standoffs: JSO

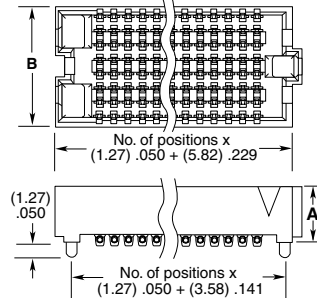
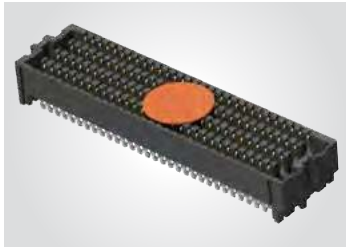

LEAD STYLE	A	NO. OF ROWS	B
-05.0	(5.05) .199	-04	(5.66) .223
-06.0	(6.05) .238	-05, -06	(8.20) .323
-06.5	(6.55) .258	-08	(10.74) .423
-07.5	(7.54) .297	-10	(13.28) .523

View complete specifications at: samtec.com?SEAF

STANDARDS

VITA 47
VITA 57.1 FMC
VITA 57.4 FMC+
VITA 74 VNX
PISMO™ 2

Visit www.samtec.com/standards for more information.

MATED HEIGHTS				
SEAM LEAD STYLE	SEAF LEAD STYLE			
	-05.0	-06.0	-06.5	-07.5
-02.0	7 mm	8 mm	8.5 mm	9.5 mm
-03.0	8 mm	9 mm	9.5 mm	10.5 mm
-03.5	8.5 mm	9.5 mm	10 mm	11 mm
-06.5	11.5 mm	12.5 mm	13 mm	14 mm
-07.0	12 mm	13 mm	13.5 mm	14.5 mm
-09.0	14 mm	15 mm	15.5 mm	16.5 mm
-11.0	16 mm	17 mm	17.5 mm	18.5 mm

Notes:
IPC-A-610F and IPC J-STD-001F Class 3 solder joint.

Severe Environment Testing qualified; aligns with MIL-DTL-55302. Visit samtec.com/set

(1.27 mm) .050" PITCH • RIGHT-ANGLE & GUIDE POST

SERIES	POSITIONS PER ROW	01	PLATING OPTION	NO. OF ROWS	SOLDER TYPE	RA	OPTIONS	"X"R
SEAM Right-Angle Terminal	-20		-L = 10 μ" (0.25 μm) Gold on contact area, Matte Tin on solder tail	-04 -06 -08 -10	-1 = Tin/Lead Alloy Solder Charge -2 = Lead-Free Solder Charge		-GP = Guide Post/Hole -K = Polyimide Film Pick & Place Pad -LP Latch Post (Available with SEAF in -06 Row with 30 positions only; Required for mating to SEAC)	-TR = Tape & Reel -FR = Full Reel Tape & Reel (must order max. quantity per reel; contact Samtec for quantity breaks)
	-30							
SEAF Right-Angle Socket	-40							
-50								

SEAM-RA

Board Mates:
SEAF, SEAF-RA,
SEAFP

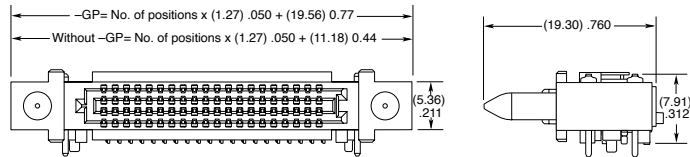

SEAF-RA

Board Mates:
SEAM, SEAMP

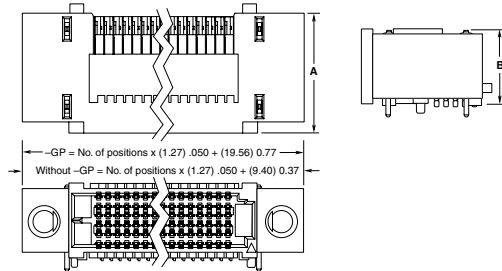

NO. PINS PER ROW	A	B
-04	(13.77) .542	(7.91) .311
-06	(16.31) .642	(10.45) .411
-08	(18.85) .742	(12.99) .511
-10	(21.39) .842	(15.53) .611

View complete specifications at: samtec.com?SEAM-RA & samtec.com?SEAF-RA

SERIES	POSITIONS PER ROW	02.0	PLATING OPTION	NO. OF ROWS	SOLDER TYPE	A	GP	K	"X"R
SEAM Terminal with Guide post	-20, -30, -40, -50		-L = 10 μ" (0.25 μm) Gold on contact area, Matte Tin on solder tail -S = 30 μ" (0.76 μm) Gold on contact area, Matte Tin on solder tail	-04 -06 -08 -10	-1 = Tin/Lead Alloy Solder Charge -2 = Lead-Free Solder Charge				-TR = Tape & Reel -FR = Full Reel Tape & Reel (must order max. quantity per reel; contact Samtec for quantity breaks)
SEAM-GP									
Board Mates: SEAF-RA-GP									

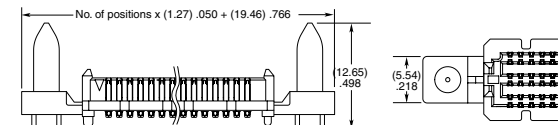
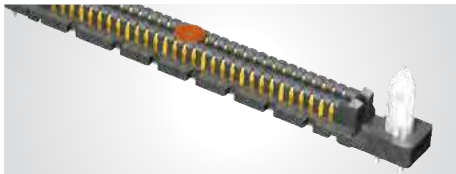

View complete specifications at: samtec.com?SEAM

Note: Some lengths, styles and options are non-standard, non-returnable

(1.27 mm) .050" PITCH • PRESS-FIT & 85 Ω OPEN-PIN-FIELD ARRAYS

SERIES	POSITIONS PER ROW	LEAD STYLE	PLATING OPTION	NO. OF ROWS	OPTION	PACKAGING
SEAMP Terminal	-10, -20, -30, -40, -50	-02.0 (SEAMP only)	-L = 10 μ" (0.25 μm) Gold on contact area, Matte Tin on tail	-04, -06, -08, -10	-GP Guide Post (SEAMP only)	-TR = Tape & Reel
SEAFP Socket		-05.0 (SEAFP only)	-S = 30 μ" (0.76 μm) Gold on contact area, Matte Tin on tail	SEAFP: -04 & -06 Rows only		-FR = Full Reel Tape & Reel (must order max. quantity per reel; contact Samtec for quantity breaks)

SEAMP
Board Mates:
SEAF,
SEAF-RA-GP,
SEAFP

NO. OF ROWS	A
-04	(7.06) .278
-06	(9.60) .378
-08	(12.14) .478
-10	(14.68) .578

SEAFP
Board Mates:
SEAM,
SEAM-RA,
SEAMP

NO. OF ROWS	A
-04	(5.61) .221
-06	(8.15) .321

View complete specifications at: samtec.com?SEAMP & samtec.com?SEAFP. Visit samtec.com?SEAFP-RA for right-angle socket.

SERIES	POSITIONS PER ROW	LEAD STYLE	NO. OF ROWS	085
SEAR 85 Ω Tuned Riser	-40, -50	-10.0 = 20 mm Mated Height -20.0 = 30 mm Mated Height -30.0 = 40 mm Mated Height	-06, -08, -10	

SEAR
Board Mates:
SEAFC

POSITIONS PER ROW	A
-40	(71.42) 2.812
-50	(84.12) 3.312

NO. OF ROWS	B
-06	(11.43) .450
-08	(13.97) .550
-10	(16.51) .650

SERIES	POSITIONS PER ROW	11.0	PLATING OPTION	NO. OF ROWS	SOLDER TYPE	A	K	"X"R
SEAMI 85 Ω Tuned Terminal	-40 -50		-L = 10 μ" (0.25 μm) Gold on contact area, Matte Tin on solder tail	-08 -10	-1 = Tin/Lead Alloy SolderCharge			-TR = Tape & Reel
SEAMI			-S = 30 μ" (0.76 μm) Gold on contact area, Matte Tin on solder tail		-2 = Lead-Free Solder Charge			-FR = Full Reel Tape & Reel (must order max. quantity per reel; contact Samtec for quantity breaks)

SEAMI
Board Mates:
SEAF

Note: Some lengths, styles and options are non-standard, non-returnable

NO. OF ROWS	A
-08	(13.41) .528
-10	(15.95) .628

View complete specifications at: samtec.com?SEAR & samtec.com?SEAMI.

SEARAY™ .8mm

ULTRA HIGH-DENSITY, HIGH-SPEED OPEN-PIN-FIELD ARRAYS

(0.80 mm) .0315" PITCH

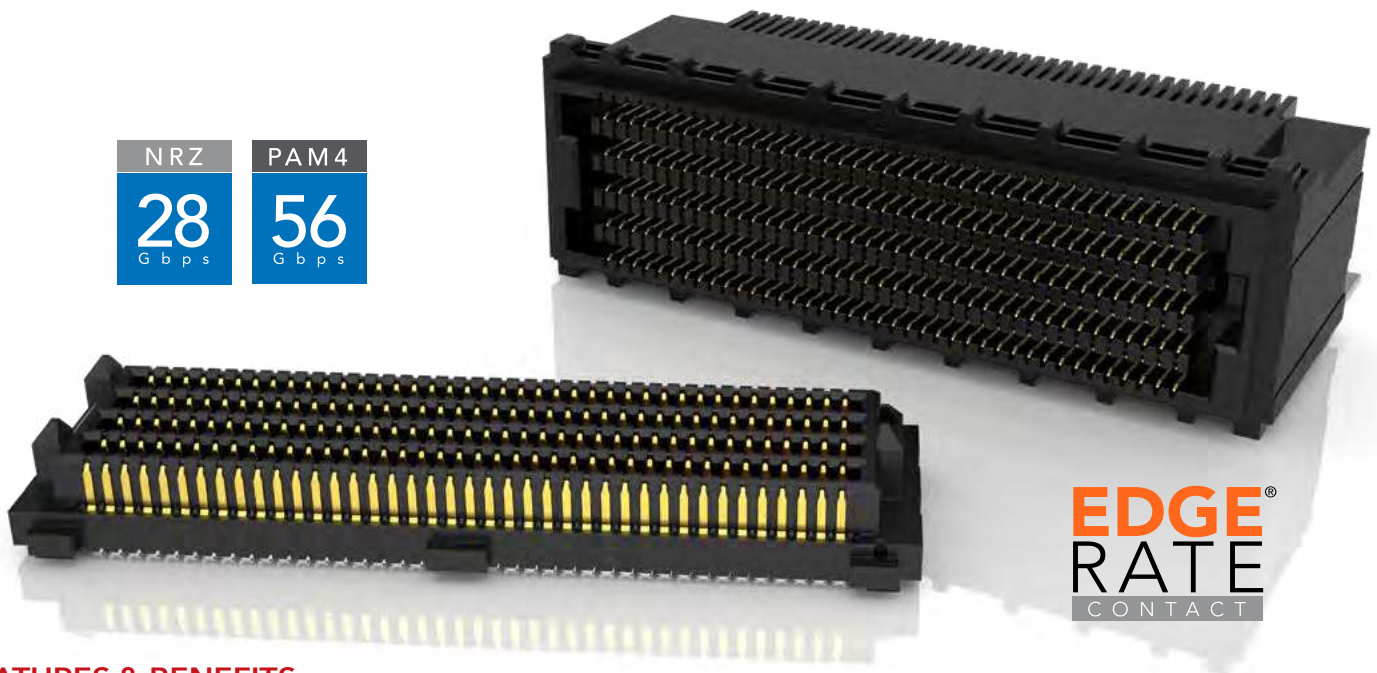

NRZ	PAM4
28 Gbps	56 Gbps

FEATURES & BENEFITS

- 0.80 mm (.0315") pitch grid
- 50% board space savings versus .050" (1.27 mm) pitch arrays
- Performance up to 28 Gbps NRZ/56 Gbps PAM4
- Rugged Edge Rate® contact system
- Up to 500 I/Os
- 7 mm and 10 mm stack heights
- Solder charge terminations for ease of processing
- Lower insertion/withdrawal forces
- Severe Environment Testing qualified (SEAM8/SEAF8); aligns with MIL-DTL-55302. Visit samtec.com/set

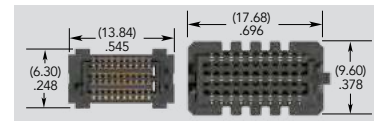

0.80 mm pitch vs. 1.27 mm pitch (60 pins shown)

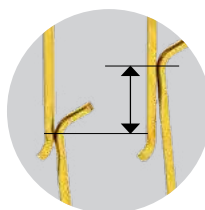

(1.12 mm) .044" Nominal Wipe

MAXIMUM GROUNDING & ROUTING FLEXIBILITY

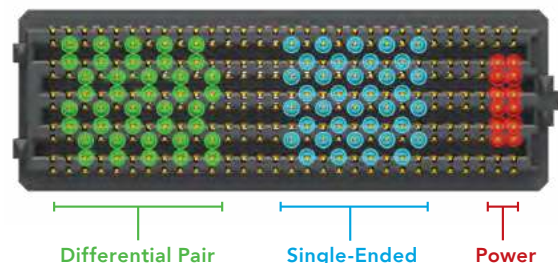

KEY SPECIFICATIONS (SEAF8/SEAM8)

SERIES	INSULATOR MATERIAL	CONTACT MATERIAL	PLATING	OPERATING TEMP RANGE	CURRENT RATING	VOLTAGE RATING	LEAD-FREE SOLDERABLE
SEAM8	Black LCP	Copper Alloy	Au or Sn over 50 μ" (1.27 μm) Ni	-55 °C to +125 °C	1.3 A per pin (10 adjacent pins powered)	220 VAC	Yes
SEAF8					1.1 A per pin (10 adjacent pins powered)		
SEAF8-RA							

(0.80 mm) .0315" PITCH • ULTRA HIGH-DENSITY ARRAYS

SERIES	NO. PINS PER ROW	LEAD STYLE	PLATING OPTION	NO. OF ROWS	SOLDER TYPE	OPTION	"X"R
SEAM8 Terminal	-10, -20, -30, -40, -50	-S02.0 = 2 mm Body Height (SEAM8 only)	-L = 10 μm (0.25 μm) Gold on contact area, Matte Tin on solder tail	-04	-1 = Tin/Lead Alloy Solder Crimp (-STL only)	-GP = Guide Post (-S02.0 lead style only) (Mates with SEAF8-RA-GP)	Tape & Reel is standard. Leave blank for Tape & Reel.
		-S05.0 = 5 mm Body Height (SEAM8 only)	-S = 30 μm (0.76 μm) Gold on contact area, Matte Tin on solder tail	-06			
SEAF8 Socket	-10, -20, -30, -40, -50	-S05.0 = 5 mm Body Height (SEAM8 only)	-STL = 30 μm (0.76 μm) Gold on contact, Tin/Lead on solder tail (-1 solder type only)	-08	-3 = Lead-Free Solder Crimp		-FR = Full Reel Tape & Reel (must order max. quantity per reel; contact Samtec for quantity breaks)
		-05.0 = 5 mm Body Height (SEAF8 only)		-10			

SEAM8
Board Mates:
SEAF8
Cable Mates:
ESCA
Standoffs:
J50



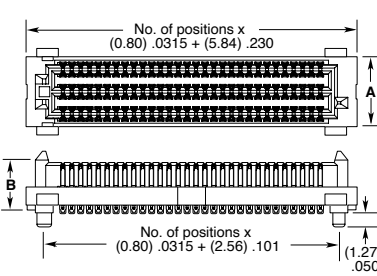

LEAD STYLE	B
-S02.0	(4.54) .179
-S05.0	(7.54) .297

NO. OF ROWS	A
-04	(4.30) .169
-06	(6.30) .248
-08	(8.30) .327
-10	(10.30) .406

View complete specifications at: samtec.com?SEAM8

SERIES	NO. PINS PER ROW	LEAD STYLE	PLATING OPTION	NO. OF ROWS	SOLDER TYPE	OPTION	"X"R
SEAF8	-20, -30, -40, -50	-S02.0 = 2 mm Body Height (SEAF8 only)	-L = 10 μm (0.25 μm) Gold on contact area, Matte Tin on solder tail	-04	-2 = Lead-Free Solder Crimp	-GP = Guide Post Holes	Tape & Reel is standard. Leave blank for Tape & Reel.
		-S05.0 = 5 mm Body Height (SEAF8 only)	-S = 30 μm (0.76 μm) Gold on contact area, Matte Tin on solder tail	-08			
SEAF8-RA (Right-angle)	-20, -30, -40, -50	-S05.0 = 5 mm Body Height (SEAF8 only)	-STL = 30 μm (0.76 μm) Gold on contact, Tin/Lead on solder tail (-1 solder type only)	-10			-FR = Full Reel Tape & Reel (must order max. quantity per reel; contact Samtec for quantity breaks)

SEAF8
Board Mates:
SEAM8
Cable Mates:
ESCA
Standoffs:
J50



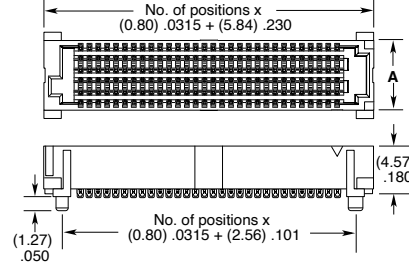

MATED HEIGHTS*

SEAF8 LEAD STYLE	SEAM8 LEAD STYLE	
	-S02.0	-S05.0
-05.0	(7.00) .276	(10.00) .394

*Processing conditions will affect mated height.

Notes:
Polyimide Pick & Place Pad standard without specifying -K.
Severe Environment Testing qualified; aligns with MIL-DTL-55302. Visit samtec.com/set

View complete specifications at: samtec.com?SEAF8

SERIES	NO. PINS PER ROW	LEAD STYLE	PLATING OPTION	NO. OF ROWS	SOLDER TYPE	OPTION	"X"R
SEAF8	-20, -30, -40, -50	-S02.0 = 2 mm Body Height (SEAF8 only)	-L = 10 μm (0.25 μm) Gold on contact area, Matte Tin on solder tail	-04	-2 = Lead-Free Solder Crimp	-GP = Guide Post Holes	Tape & Reel is standard. Leave blank for Tape & Reel.
		-S05.0 = 5 mm Body Height (SEAF8 only)	-S = 30 μm (0.76 μm) Gold on contact area, Matte Tin on solder tail	-08			
SEAF8-RA (Right-angle)	-20, -30, -40, -50	-S05.0 = 5 mm Body Height (SEAF8 only)	-STL = 30 μm (0.76 μm) Gold on contact, Tin/Lead on solder tail (-1 solder type only)	-10			-FR = Full Reel Tape & Reel (must order max. quantity per reel; contact Samtec for quantity breaks)

SEAF8-RA
(Right-angle)
Board Mates:
SEAM8
Cable Mates:
ESCA



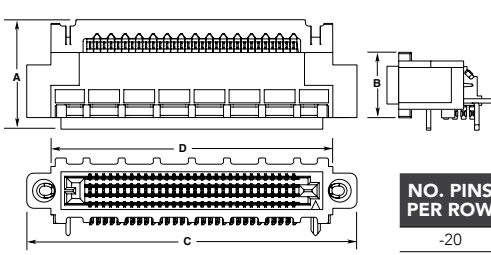

NO. OF ROWS	A	B
-04	(12.48) .491	(7.46) .294
-08	(16.48) .649	(11.46) .451
-10	(18.48) .728	(13.46) .530

NO. PINS PER ROW	C	D
-20	(29.62) 1.166	(24.12) .950
-30	(37.62) 1.481	(32.12) 1.265
-40	(45.62) 1.796	(40.12) 1.580
-50	(53.62) 2.111	(48.12) 1.894

View complete specifications at: samtec.com?SEAF8-RA

LPARRAY™

LOW PROFILE OPEN-PIN-FIELD ARRAYS

(1.27 mm) .050" PITCH



FEATURES & BENEFITS

- 4 mm, 4.5 mm, 5 mm stack heights
- Up to 400 I/Os
- 4, 6 and 8 row designs
- .050" (1.27 mm) pitch
- Dual beam contact system
- Solder crimp termination for ease of processing
- Board stacking standoffs available to assist with unmating and reduce risk for component damage on board

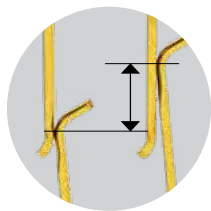

(0.51 mm) .020"
Nominal Wipe

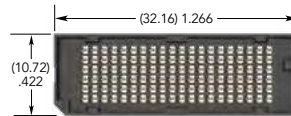

LPAM Series; 120 pins

MAXIMUM GROUNDING & ROUTING FLEXIBILITY

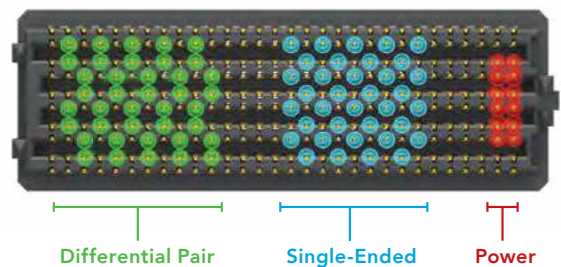

KEY SPECIFICATIONS (LPAM/LPAF)

PITCH	TOTAL PINS	INSULATOR MATERIAL	CONTACT MATERIAL	PLATING	CURRENT RATING	WORKING VOLTAGE	LEAD-FREE SOLDERABLE
1.27 mm x 1.27 mm	Up to 400 I/Os	Black LCP	Copper Alloy	Au or Sn over 50 μ" (1.27 μm) Ni	2.2 A per pin (8 adjacent pins powered)	250 VAC	YES

(1.27 mm) .050" PITCH • LOW PROFILE OPEN-PIN-FIELD ARRAYS

SERIES	NO. PINS PER ROW	LEAD STYLE	PLATING OPTION	NO. OF ROWS	SOLDER TYPE	K	"X"R
LPAM Terminal	-10, -20, -30, -40,	-01.0 = (1.0 mm) .039" (LPAM only)	-L = 10 μ" (0.25 μm) Gold on contact area, Matte Tin on solder tail	-04 -06 -08	-1 = Tin/Lead Alloy Solder Crimp		-K = Polyimide film Pick & Place Pad
LPAF Socket	-50 (-08 rows only)	-01.5 = (1.5 mm) .060" (LPAM only)	-S = 30 μ" (0.76 μm) Gold on contact area, Matt Tin on solder tail		-2 = Lead-Free Solder Crimp		-TR =Tape & Reel
		-03.0 = (3.0 mm) .118" (LPAF only)					-FR =Full Reel Tape & Reel (must order max. quantity per reel; contact Samtec for quantity breaks)
		-03.5 = (3.5 mm) .138" (LPAF only)					

LPAM
Board Mates:
LPAF
Standoffs:
JSO, SO

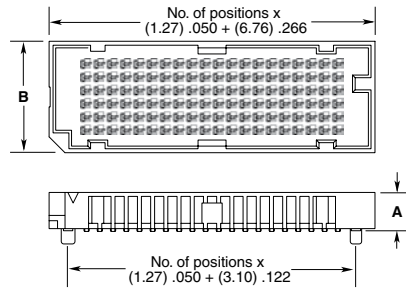
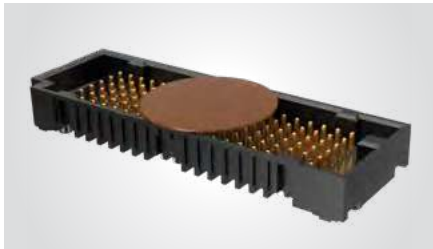

NO. OF ROWS	B
-04	(8.18) .322
-06	(10.72) .422
-08	(13.26) .522

LEAD STYLE	A
-01.0	(3.68) .145
-01.5	(4.19) .165

View complete specifications at: samtec.com?LPAM

LPAF
Board Mates:
LPAM
Standoffs:
JSO, SO

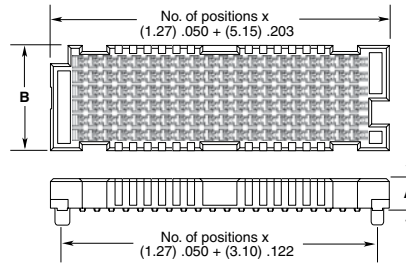
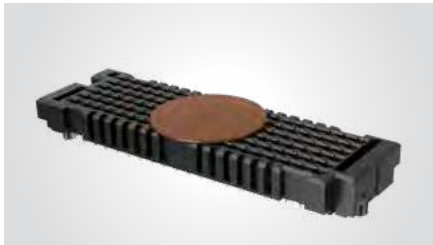

NO. OF ROWS	B
-04	(6.71) .264
-06	(9.25) .364
-08	(11.79) .464

LEAD STYLE	A
-03.0	(2.79) .110
-03.5	(3.30) .130

MATED HEIGHTS*		
LPAM LEAD STYLE	LPAF LEAD STYLE	
	-03.0	-03.5
-01.0	(4.00) .157	(4.50) .177
-01.5	(4.50) .177	(5.00) .197

*Processing conditions will affect mated height.

Notes:
Some sizes, styles and options are non-standard, non-returnable

View complete specifications at: samtec.com?LPAF

SUPERNOVA™ LOW PROFILE COMPRESSION INTERPOSER

PAM4
56
Gbps



(1.00 mm) .0394" PITCH • GMI SERIES

SPECIFICATIONS

Insulator Material:
Black LCP
Contact Material:
Copper Alloy
Plating:
Au or 50 μ" (1.27 μm) Ni
Current Rating:
.89 A per pin
(10 pins powered)

GMI

POSITIONS
PER ROW

-10, -20, -30

STYLE

-2
= Dual
Compression

BOARD
SPACING

-1.27
= (1.27 mm) .050"
Board Space

PLATING
OPTION

-G
= 10 μ"
(0.25 μm)
Gold on
contact area

ROWS

-10
= Ten Rows

PROCESSING

Lead-Free Solderable:
Yes
SMT Lead Complanarity:
(0.05 mm) .002" (10-20)*
(0.08 mm) .003" (30)*
*(.004" stencil solution
may be available;
contact ipg@samtec.com)

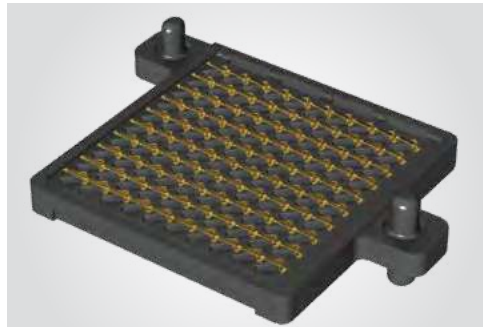

GMI Series is an ideal low-cost solution
for board stacking, module-to-board or
LGA interface

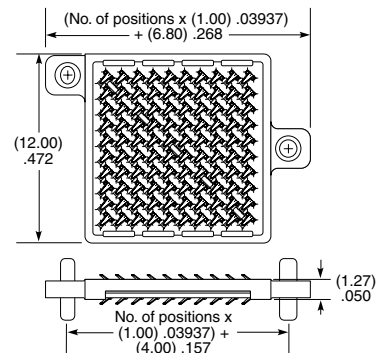

10 X 10

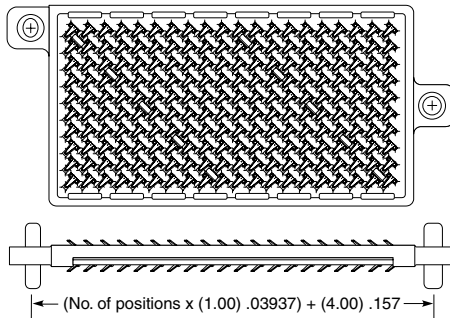

20 X 10

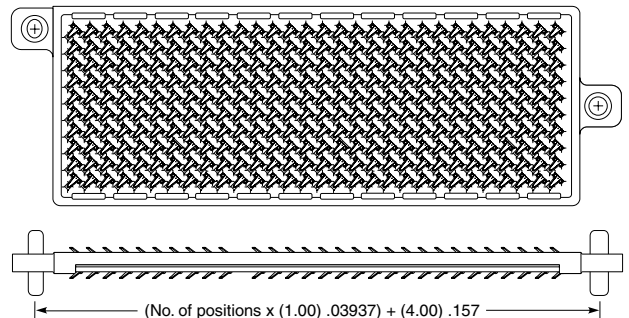

30 X 10

Note:
Some lengths, styles and
options are non-standard,
non-returnable

JACK SCREW STANDOFF

JSO SERIES



JSO
Use With:
SEAX, SEAX8, LPAX, LSHM

JSO

**BOARD
STACKER**

LEAD STYLE

**PLATING
OPTION**

SPECIFICATIONS

Material:
Stainless Steel
Locking Compound:
Nylon

Specify
BOARD STACKER
from chart

-01
= Press-In
(-0415, -0515, -0715, -0815 only)

-03
= Male Thread
(-0815, -1015, -1115, -1615 only)

-L
= Locking compound
(Not available with -01 lead style,
Required for -03 lead style)

BOARD STACKER	A	B	BOARD STACK HEIGHT
-0415	(4.15) .163	(2.50) .098	4 mm
-0515	(5.15) .203	(3.50) .138	5 mm
-0715	(7.15) .281	(5.50) .217	7 mm
-0815	(8.15) .321	(6.50) .256	8 mm
-1015	(10.15) .400	(8.50) .335	10 mm
-1115	(11.15) .439	(9.50) .374	11 mm
-1615	(16.15) .636	(14.50) .571	16 mm

ALSO AVAILABLE

MOQ Required

Other heights
Locking compound removed

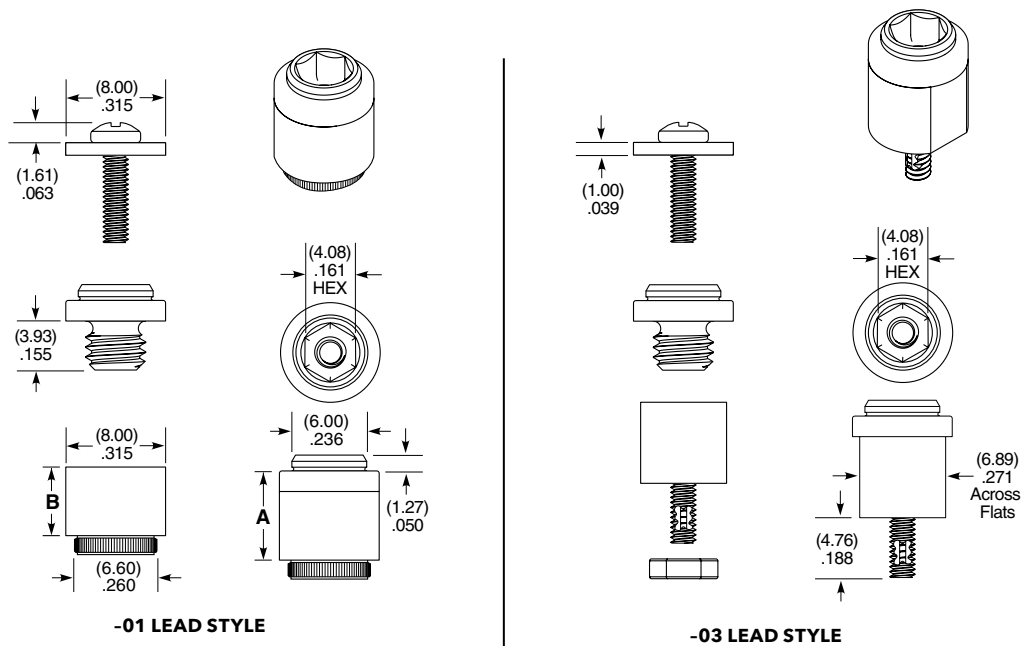

Note:
Some sizes, styles and
options are non-standard,
non-returnable.

Components are to be packaged in separate bags unassembled.

APPLICATION

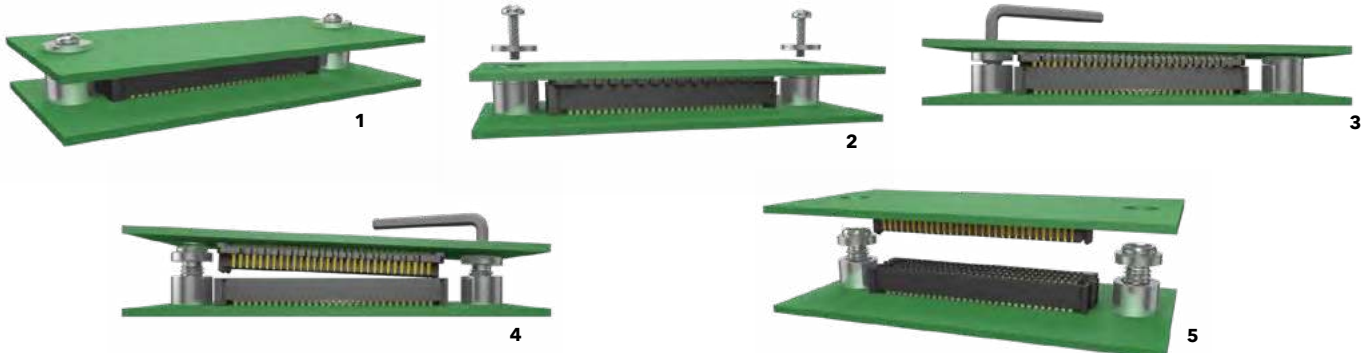

BOARD-TO-BOARD GUIDE POST STANDOFF

GPSO SERIES

GPSO
Use With:
NVAX, APX6, ADX6,
UMPX, UDX6

SPECIFICATIONS

Locking Compound:
Nylon

BOARD STACK HEIGHT	A	B	C
-0500	(5.00) .197	(4.15) .163	(4.65) .183
-0515	(5.15) .203	(4.30) .169	(4.80) .189
-0700	(7.00) .276	(6.15) .242	(6.65) .262
-0715	(7.15) .281	(6.30) .248	(6.80) .268
-0865	(8.65) .341	(7.80) .307	(8.30) .327
-0900	(9.00) .354	(8.15) .321	(8.65) .341
-0915	(9.15) .360	(8.30) .327	(8.80) .346
-1000	(10.00) .394	(9.15) .360	(9.65) .380
-1015	(10.15) .400	(9.30) .366	(9.80) .386
-1115	(11.15) .439	(10.30) .406	(10.80) .425
-1200	(12.00) .472	(11.15) .439	(11.65) .459
-1215	(12.15) .478	(11.30) .445	(11.80) .465
-1315	(13.15) .518	(12.30) .484	(12.80) .504
-1415	(14.15) .557	(13.30) .524	(13.80) .543
-1515	(15.15) .596	(14.30) .563	(14.80) .583
-1524	(15.24) .600	(14.39) .567	(14.89) .586
-1615	(16.15) .636	(15.30) .602	(15.80) .622

Notes:
Standoffs to be used with
(1.57 mm) .062" min thick boards.
Threaded options PCB max
thickness of (3.16 mm) .124".

Some sizes, styles and options are
non-standard, non-returnable.

GPSO	BOARD STACK HEIGHT	LEAD STYLE	MATERIAL	KIT OPTION
	Specify BOARD STACK HEIGHT from chart	-01 = Press-In -02 = Press-In with Nut	-01 = 303 Stainless Steel with MIL-C-13924 black oxide finish	-N = No hardware (Standoff only) Leave blank for kit

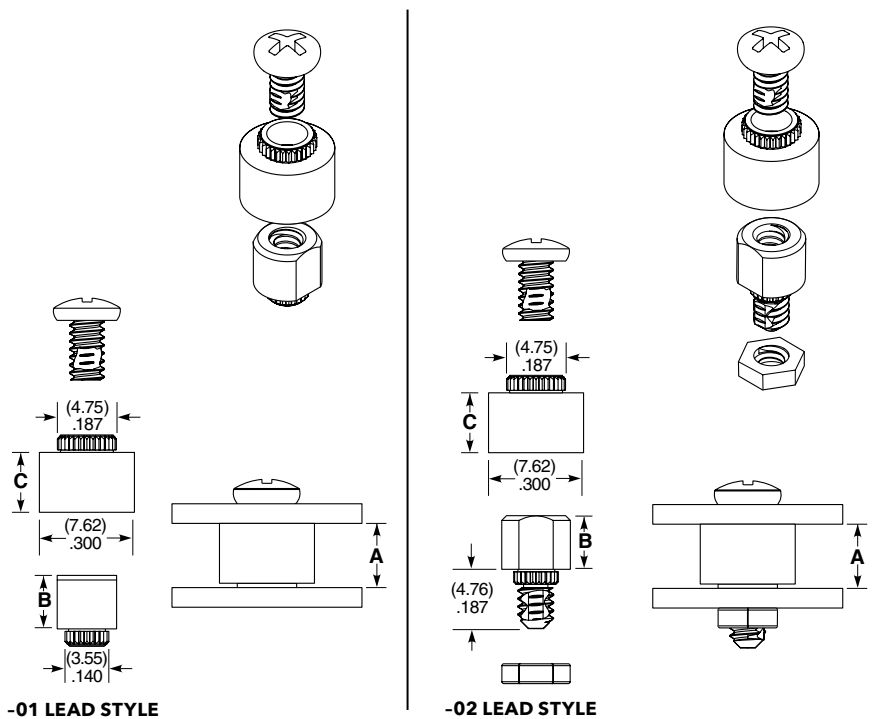

Components are to be packaged in separate bags unassembled.
Top and bottom components available for purchase separately, contact Samtec.

APPLICATIONS

GPSO mated with ADX6

GPSO mated with UMPX

Allows for 0.035" of initial misalignment

Alignment starts before connectors engage.

HIGH-SPEED MEZZANINE SYSTEMS

25+ Gbps PERFORMANCE • INTEGRAL GROUND PLANE • EDGE RATE® CONTACTS

37-39 Q STRIP® INTEGRAL GROUND PLANE INTERCONNECTS

0.50 mm (.0197") Pitch (QTH, QSH)
0.80 mm (.0315") Pitch (QTE, QSE)
0.635 mm (.025") Pitch (QTS, QSS)



40-41 Q2™ RUGGED INTEGRAL GROUND PLANE INTERCONNECTS

0.635 mm (.025") Pitch (QMS, QFS)
0.635 mm (.025") Pitch Shielded (QMSS, QFSS)

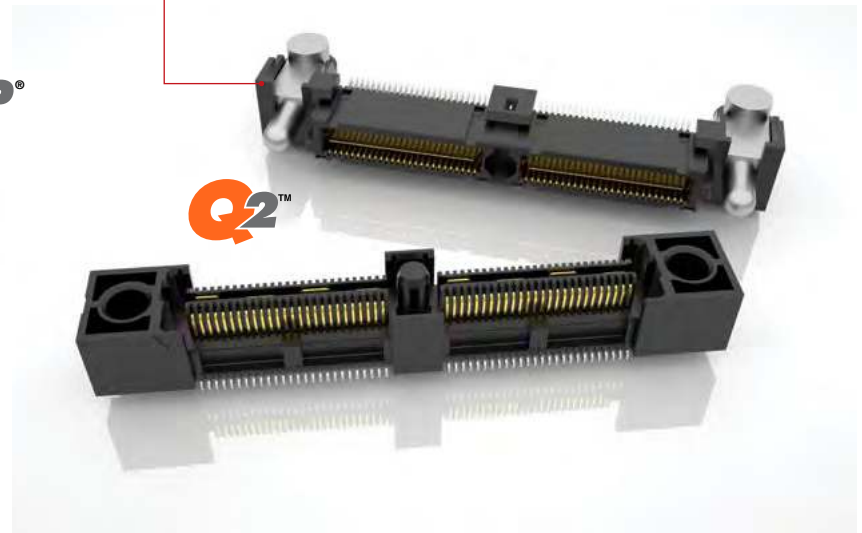

42 Q RATE® SLIM BODY INTEGRAL GROUND PLANE INTERCONNECTS

0.80 mm (.0315") Pitch (QRM8, QRF8)

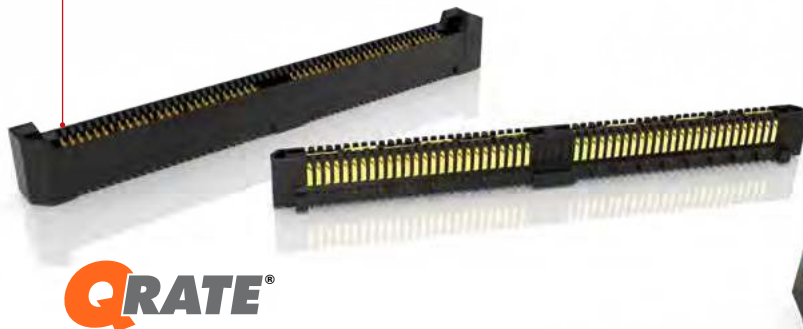

47-52 EDGE RATE® RUGGED HIGH-SPEED INTERCONNECTS

0.50 mm (.0197") Pitch (ERM5, ERF5)
0.635 mm (.025") Pitch (ERM6, ERF6)
0.80 mm (.0315") Pitch (ERM8, ERF8)

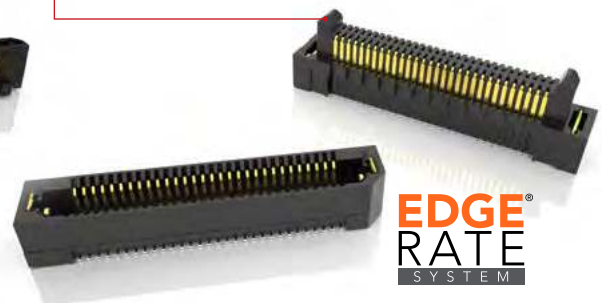



HIGH-SPEED GROUND PLANE MEZZANINE CONNECTORS

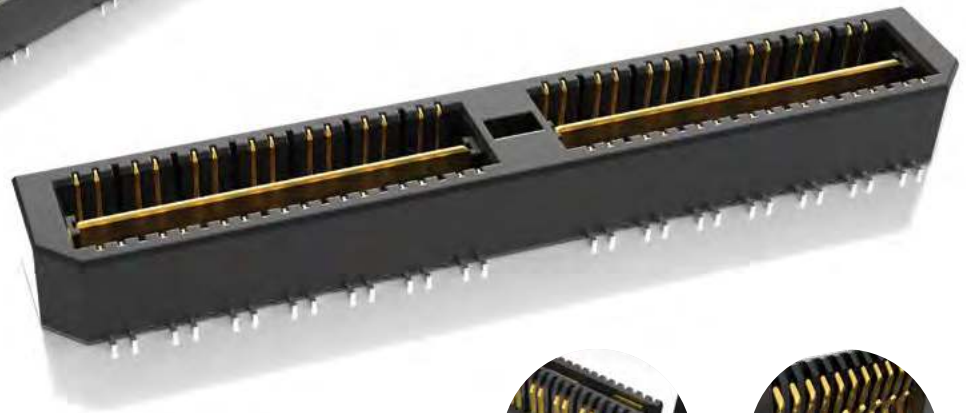

FEATURES & BENEFITS

- Designed for high-speed board-to-board applications where signal integrity is essential
- Q Strip® low profile connectors on 0.50 mm, 0.635 mm and 0.80 mm pitches
- Q Rate® slim connectors with Edge Rate® contacts on 0.80 mm pitch with a 1.20 mm contact wipe
- Q2™ rugged connectors on 0.635 mm pitch with increased insertion depth for rugged applications
- Right-angle, edge mount, EMI shielding and power options
- Differential pair and single-ended routing



Differential Pairs
Reduce Noise



Rugged Edge Rate®
Contact System



Power, Retention
& RF Options



Precision Board
Stacking Standoffs

INTEGRAL GROUND / POWER PLANE

- Surface mount ground plane between two signal rows improves electrical performance
- Significantly reduces row-to-row crosstalk
- Integral metal plane for power to 25 Amps





(0.50 mm) .0197" PITCH • QTH/QSH SERIES

QTH
Board Mates:
QSH

QSH
Board Mates:
QTH

QTH/QSH
Cable Mates:
HQCD, HQDP

Standoffs:
SO

QTH	PINS PER ROW NO. OF PAIRS	LEAD STYLE	PLATING OPTION	TYPE	A	OTHER OPTIONS	"X"R
	-030, -060, -090 (60 total pins per bank = -D)	Specify LEAD STYLE from chart	-F = Gold flash on contact, Matte Tin on tail	-D = Single-Ended		-K = (7.00 mm) .275" DIA Polyimide film Pick & Place Pad (Not available with -05 & -07 lead style)	Leave blank for Tray Packaging
	-020, -040, -060 (20 pairs per bank = -D-DP)		-L = 10 μ" (0.25 μm) Gold on contact, Matte Tin on tail	-D-DP = Differential Pair (-01 only)		-L = Latching Option (-01 lead style only) (Not available on -060 (-D-DP) & -090)	-TR =Tape & Reel (Not available with -05 & -07 lead style)
			-C = 50 μ" (1.27 μm) Electro-Polished Selective Gold on contact, Matte Tin on tail (passes 10 year MFG testing)				-FR = Full Reel Tape & Reel (must order max. quantity per reel; contact Samtec for quantity breaks) (Not available with -05 & -07 lead style)

SPECIFICATIONS

Insulator Material:
Liquid Crystal Polymer
Contact Material:
Phosphor Bronze
Plating:
Au or Sn over 50 μ" (1.27 μm) Ni
Current Rating:
Contact:
2 A per pin (2 pins powered)
Ground Plane:
25 A per ground plane (1 ground plane powered)
Operating Temp Range:
-55 °C to +125 °C
Voltage Rating:
175 VAC (5 mm Stack Height)
Max Cycles:
100

QTH LEAD STYLE	A	HEIGHT WITH QSH*
-01	(4.27) .168	(5.00) .197
-02	(7.26) .286	(8.00) .315
-03	(10.27) .404	(11.00) .433
-04	(15.25) .600	(16.00) .630
-05	(18.26) .718	(19.00) .748
-07	(24.24) .954	(25.00) .984
-09	(13.26) .522	(14.00) .551

*Processing conditions will affect mated height. See SO Series for board space tolerances.

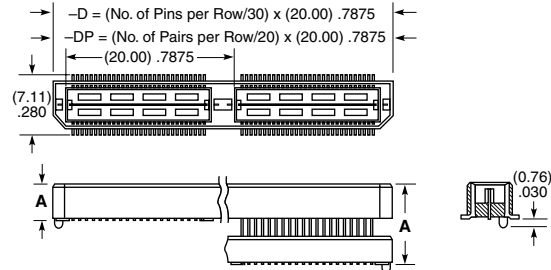

-01 & -02 -03 THRU -09

PROCESSING

Lead-Free Solderable:
Yes
SMT Lead Coplanarity:
(0.10 mm) .004" max (030-060)
(0.15 mm) .006" max (090)*
*(.004" stencil solution may be available; contact ipg@samtec.com)
Board Stacking:
For applications requiring more than two connectors contact ipg@samtec.com

View complete specifications at: samtec.com?QTH

QSH	PINS PER ROW NO. OF PAIRS	01	PLATING OPTION	TYPE	A	OTHER OPTIONS	"X"R
	-030, -060, -090 (60 total pins per bank = -D)		-F = Gold flash on contact, Matte Tin on tail	-D = Single-Ended		-K = (8.25 mm) .325" DIA Polyimide film Pick & Place Pad	Leave blank for Tray Packaging
	-020, -040, -060 (20 pairs per bank = -D-DP)		-L = 10 μ" (0.25 μm) Gold on contact, Matte Tin on tail	-D-DP = Differential Pair		-L = Latching Option (Not available on -060 (-D-DP) & -090)	-TR =Tape & Reel (N/A -05 to -07 lead style)
			-C = 50 μ" (1.27 μm) Electro-Polished Selective Gold on contact, Matte Tin on tail (passes 10 year MFG testing)				-FR = Full Reel Tape & Reel (must order max. quantity per reel; contact Samtec for quantity breaks)

STANDARDS

PISMO™ 1:
Visit samtec.com/standards for more information.

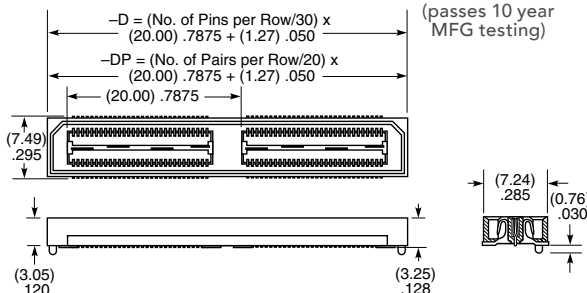

Note:
Some lengths, styles and options are non-standard, non-returnable.

View complete specifications at: samtec.com?QSH



(0.80 mm) .0315" PITCH • QTE/QSE SERIES

QTE
Board Mates:
QSE

QSE
Board Mates:
QTE

QTE/QSE
Cable Mates:
EQCD, EQDP

Standoffs:
SO

QTE	PINS PER ROW NO. OF PAIRS	LEAD STYLE	PLATING OPTION	TYPE	A	OTHER OPTIONS	"X"R
	-020, -040, -060 (40 total pins per bank = -D)	Specify LEAD STYLE from Chart	-F = Gold flash on contact, Matte Tin on tail	-D = Single-Ended		-K = (7.00 mm) .275" DIA Polyimide film Pick & Place Pad	Leave blank for Tray Packaging
	-014, -028, -042 (14 pairs per bank = -D-DP)		-L = 10 μ" (0.25 μm) Gold on contact, Matte Tin on tail	-D-DP = Differential Pair (-01 only)		-L = Latching Option (N/A on -042 & -060 positions)	-TR = Tape & Reel (Not available with -05 & -07 lead style)
			-C = 50 μ" (1.27 μm) Electro-Polished Selective Gold on contact, Matte Tin on tail (passes 10 year MFG testing)				-FR = Full Reel Tape & Reel (must order max. quantity per reel; contact Samtec for quantity breaks) (Not available with -05 & -07 lead style)

SPECIFICATIONS

Insulator Material: Liquid Crystal Polymer
Contact Material: Phosphor Bronze
Plating: Au or Sn over 50 μ" (1.27 μm) Ni
Current Rating: Contact: 2 A per pin (2 pins powered) Ground Plane: 23 A per ground plane (1 ground plane powered)
Operating Temp Range: -55 °C to +125 °C
Voltage Rating: 225 VAC when mated & 5 mm Stack Height
Max Cycles: 100

QTE LEAD STYLE	A	HEIGHT WITH QSE*
-01	(4.27) .168	(5.00) .197
-02	(7.26) .286	(8.00) .315
-03	(10.27) .404	(11.00) .433
-04	(15.25) .600	(16.00) .630
-05	(18.26) .718	(19.00) .748
-07	(24.24) .954	(25.00) .984
-09	(13.26) .522	(14.00) .551

*Processing conditions will affect mated height. See SO Series for board space tolerances.

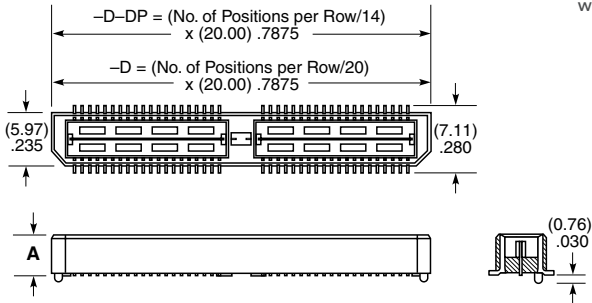

View complete specifications at: samtec.com?QTE

PROCESSING

Lead-Free Solderable: Yes
SMT Lead Coplanarity: (0.10 mm) .004" max (020-060)
Board Stacking: For applications requiring more than two connectors contact ipg@samtec.com



QSE	PINS PER ROW NO. OF PAIRS	01	PLATING OPTION	TYPE	A	OTHER OPTIONS	"X"R
	-020, -040, -060 (40 total pins per bank = -D)		-F = Gold flash on contact, Matte Tin on tail	-D = Single-Ended		-GP = Guide Post	Leave blank for Tray Packaging
	-014, -028, -042 (14 pairs per bank = -D-DP)		-L = 10 μ" (0.25 μm) Gold on contact, Matte Tin on tail	-D-DP = Differential Pair		-K = (8.25 mm) .325" DIA Polyimide Film Pick & Place Pad	-TR = Tape & Reel (40 positions max. with -GP)
			-C = 50 μ" (1.27 μm) Electro-Polished Selective Gold on contact, Matte Tin on tail (passes 10 year MFG testing)			-L = Latching Option (Not available on -042 & -060 positions)	-FR = Full Reel Tape & Reel (must order max. quantity per reel; contact Samtec for quantity breaks) (40 positions max. with -GP)

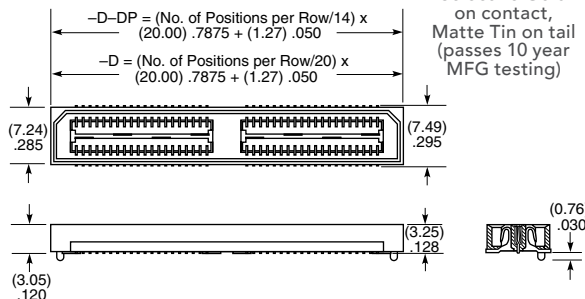

Note: Some lengths, styles and options are non-standard, non-returnable.

View complete specifications at: samtec.com?QSE



NRZ
25
Gbps



(0.635 mm) .025" PITCH • QTS/QSS SERIES

QTS
Board Mates:
QSS

QSS
Board Mates:
QTS

QTS/QSS
Cable Mates:
SQCD

Standoffs:
SO



-025, -050, -075
(50 total positions per bank)

Specify LEAD STYLE from Chart

-F
= Gold flash on contact, Matte Tin on tail

-L
= 10 μ" (0.25 μm) Gold on contact, Matte Tin on tail

-C
= 50 μ" (1.27 μm) Electro-Polished Selective Gold on contact, Matte Tin on tail (passes 10 year MFG testing)

-K
= (7.00 mm) .275" DIA Polyimide film Pick & Place Pad

Leave blank for Tray Packaging

-TR
= Tape & Reel

-FR
= Full Reel Tape & Reel must order max. quantity per reel; contact Samtec for quantity breaks)

SPECIFICATIONS

Insulator Material: Liquid Crystal Polymer
Contact Material: Phosphor Bronze
Plating: Au or Sn over 50 μ" (1.27 μm) Ni
Current Rating: Contact: 1.8 A per pin (2 pins powered) Ground Plane: 23.1 A per ground plane (1 ground plane powered)
Operating Temp Range: -55 °C to +125 °C
Voltage Rating: 285 VAC
Max Cycles: 100

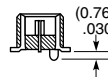
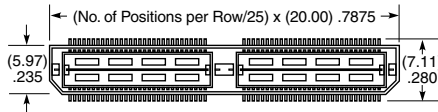

QTS LEAD STYLE	A	MATED HEIGHT WITH QSS
-01	(4.27) .168	(5.00) .197
-02	(7.26) .286	(8.00) .315

*Processing conditions will affect mated height. See SO Series for board space tolerances.

View complete specifications at: samtec.com?QTS

PROCESSING

Lead-Free Solderable: Yes
QTS SMT Lead Coplanarity: (0.10 mm) .004" max (025-075)
QSS SMT Lead Coplanarity: (0.10 mm) .004" max (025-050) (0.15 mm) .006" max (075)* *(.004" stencil solution may be available; contact ipg@samtec.com)
Board Stacking: For applications requiring more than two connectors contact ipg@samtec.com



-025, -050, -075
(50 total positions per bank)

-F
= Gold flash on contact, Matte Tin on tail

-L
= 10 μ" (0.25 μm) Gold on contact, Matte Tin on tail

-C
= 50 μ" (1.27 μm) Electro-Polished Selective Gold on contact, Matte Tin on tail (passes 10 year MFG testing)

-GP
= Guide Holes for mating with QTS-RA

-K
= (8.25 mm) .325" DIA Polyimide Film Pick & Place Pad

Leave blank for Tray Packaging

-TR
= Tape & Reel

-FR
= Full Reel Tape & Reel must order max. quantity per reel; contact Samtec for quantity breaks)

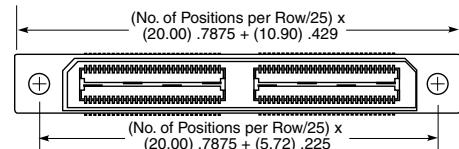
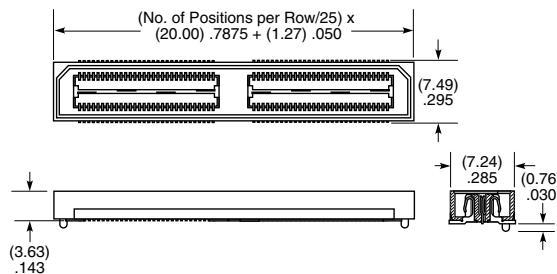

-GP OPTION

Note: Some lengths, styles and options are non-standard, non-returnable.

View complete specifications at: samtec.com?QSS



NRZ
25
Gbps

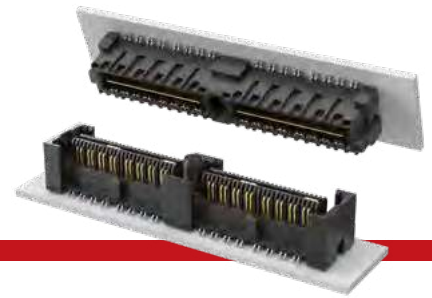

(0.635 mm) .025" PITCH • QMS/QFS SERIES

QMS
Board Mates:
QFS

QFS
Board Mates:
QMS

QMS/QFS
Cable Mates:
6QCD

Standoffs:
SO, JSOM

QMS	PINS PER ROW NO. OF PAIRS	LEAD STYLE	PLATING OPTION	TYPE	A	OTHER OPTION
-----	---------------------------	------------	----------------	------	---	--------------

-026,
-052, -078
(52 total pins per bank = -D)

Specify LEAD STYLE from Chart

-L
= 10 μ" (0.25 μm)
Gold on contact, Matte Tin on tail (-05.75 & -06.75 Lead Style Only)

-D
= Single-Ended

-D-DP
= Differential Pair

-K
= (5.50 mm) .217" DIA Polyimide film Pick & Place Pad

-016,
-032, -048
(16 pairs per bank = -D-DP)

(-078 & -048 Not available with -09.75 Lead Style)

-SL
= 10 μ" (0.25 μm)
Gold on contact, Matte Tin on tail (-09.75 Lead Style Only)

PACKAGING OPTION

Tape & Reel Options (-TR & -FR) available. Visit series web page and view engineering prints for complete specifications.

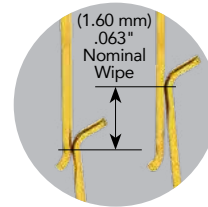

MATED HEIGHT*			
QMS LEAD STYLE	A	QFS LEAD STYLE	
		-4.25	-6.25
-05.75	(5.38) .212	10 mm	12 mm
-06.75	(6.35) .250	11 mm	13 mm
-09.75	(9.35) .368	14 mm	16 mm

*Processing conditions will affect mated height. See SO Series for board space tolerances.

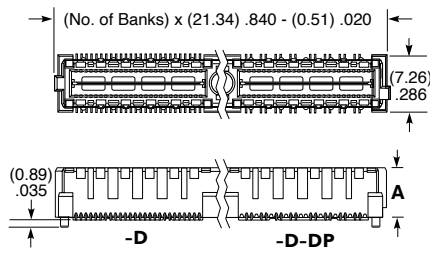

SPECIFICATIONS

Insulator Material:
Liquid Crystal Polymer
Contact & Ground Plane Material:
Phosphor Bronze
Plating:
Au over 50 μ" (1.27 μm) Ni (Tin on Ground Plane Tail)
Current Rating:
Contact:
2.6 A per pin (2 pins powered)
Ground Plane:
15.7 A per ground plane (1 ground plane powered)
Operating Temp Range:
-55 °C to +125 °C
Voltage Rating:
300 VAC

PROCESSING

Lead-Free Solderable:
Yes
QMS SMT Lead Coplanarity:
(0.10 mm) .004" max (026-052)
(0.15 mm) .006" max (078)*
*(.004" stencil solution may be available; contact ipg@samtec.com)
QFS SMT Lead Coplanarity:
(0.10 mm) .004" max (026-078)
Board Stacking:
For applications requiring more than two connectors contact ipg@samtec.com

STANDARDS

SUMIT™
PCI/104-Express™
PCI/104-Express™ OneBank

Visit samtec.com/standards for more information, including mated heights and complete part numbers.

Note:
Some lengths, styles and options are non-standard, non-returnable.

View complete specifications at: samtec.com?QMS

QFS	PINS PER ROW NO. OF PAIRS	LEAD STYLE	PLATING OPTION	TYPE	A	OTHER OPTION
-----	---------------------------	------------	----------------	------	---	--------------

-026, -052,
-078
(52 total pins per bank = -D)

Specify LEAD STYLE from Chart

-L
= 10 μ" (0.25 μm)
Gold on contact, Matte Tin on tail (-04.25 Lead Style only)

-D
= Single-Ended

-D-DP
= Differential Pair (-04.25 Lead Style only)

-GP
= Guide Holes (-04.25 Lead Style only)

-016, -032,
-048
(16 pairs per bank = -D-DP)

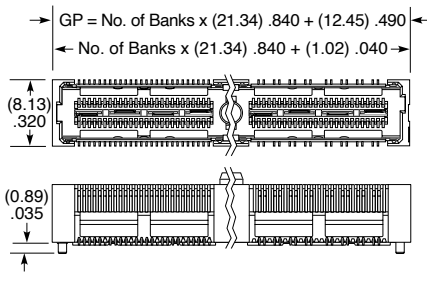

LEAD STYLE	A
-04.25	(7.44) .293
-06.25	(9.42) .371

PACKAGING OPTION

Tape & Reel Options (-TR & -FR) available. Visit series web page and view engineering prints for complete specifications.

View complete specifications at: samtec.com?QFS



NRZ

14
Gbps



(0.635 mm) .025" PITCH • QMSS/QFSS SERIES

QMSS
Board Mates:
QFSS

QFSS
Board Mates:
QMSS

QMSS/QFSS
Standoffs:
SO

QMSS	PINS PER ROW NO. OF PAIRS	06.75	PLATING OPTION	TYPE	A	OTHER OPTION
------	------------------------------	-------	-------------------	------	---	-----------------

-026, -052, -078
(52 total pins per bank / 40 signals
+ 12 grounds to shield = -D)

-016, -032, -048
(16 pairs per bank = -D-DP)

-L
= 10 μm (0.25 μm)
Gold on contact,
Matte Tin on tail

-D
= Single-
Ended

-D-DP
= Differential
Pair

-K
= (5.50 mm)
.217" DIA
Polyimide
film Pick &
Place Pad
(N/A with
-PC4)

-PC4
= 4 Power
Pins/End
(N/A with -A)

SPECIFICATIONS

Insulator Material:
Liquid Crystal Polymer
**Terminal, Ground
Plane & Shield Material:**
Phosphor Bronze
Plating:
Au over 50 μm (1.27 μm) Ni
(Tin on Ground Plane Tail)
Operating Temp Range:
-55 °C to +125 °C
Voltage Rating:
300 VAC

PROCESSING

Lead-Free Solderable:
Yes
SMT Lead Coplanarity:
(0.10 mm) .004" max
(026-078)
Board Stacking:
For applications requiring
more than two connectors
contact ipg@samtec.com

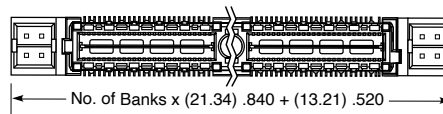
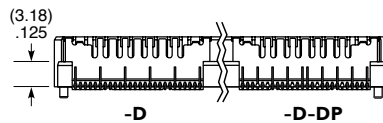
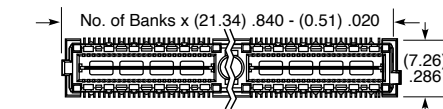

-PC4 OPTION

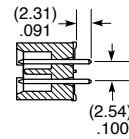
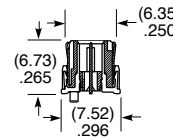

**PACKAGING
OPTION**

Tape & Reel
Options
(-TR & -FR)
available. Visit
series web
page and view
engineering prints
for complete
specifications.

View complete specifications at: samtec.com?QMSS

QFSS	PINS PER ROW NO. OF PAIRS	04.25	PLATING OPTION	TYPE	A	OTHER OPTION
------	------------------------------	-------	-------------------	------	---	-----------------

-026, -052, -078
(52 total pins per bank / 40 signals
+ 12 grounds to shield = -D)

-016, -032, -048
(16 pairs per bank = -D-DP)

-L
= 10 μm (0.25 μm)
Gold on contact,
Matte Tin on tail

-D
= Single-
Ended

-D-DP
= Differential
Pair

-PC4
= 4 Power
Pins/End
(N/A with -A)

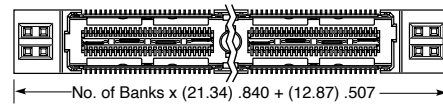
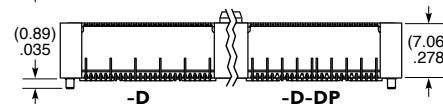
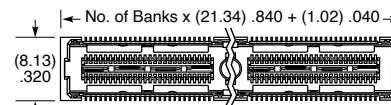
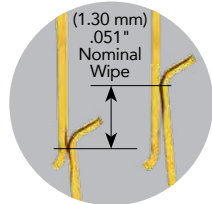

-PC4 OPTION

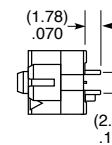
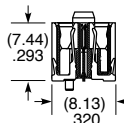

**PACKAGING
OPTION**

Tape & Reel
Options
(-TR & -FR)
available. Visit
series web
page and view
engineering prints
for complete
specifications.

Note:
Some lengths, styles and
options are non-standard,
non-returnable.

View complete specifications at: samtec.com?QFSS

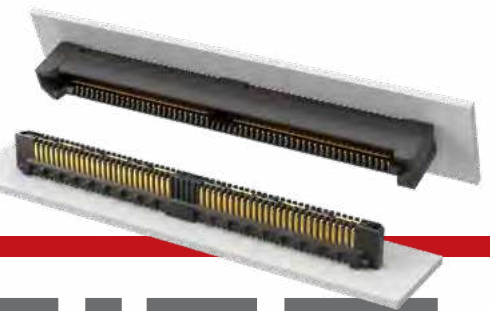

(0.80 mm) .0315" PITCH • QRM8/QRF8 SERIES

QRM8
Board Mates:
QRF8

QRF8
Board Mates:
QRM8

QRM8/QRF8
Cable Mates:
EQRD

SPECIFICATIONS

- Insulator Material:** Black LCP
- QRM8 Terminal Material:** Phosphor Bronze
- QRF8 Contact Material:** BeCu
- Ground Plane Material:** Phosphor Bronze
- Plating:** Au or Sn over 50 μ" (1.27 μm) Ni
- Current Rating:** Contact: 2.2 A per pin (2 pins powered) Ground Plane: 8.5 A per ground plane (1 ground plane powered)
- Operating Temp Range:** -55 °C to +125 °C
- Voltage Rating:** 215 VAC
- Max Cycles:** 100

QRM8	PINS PER ROW NO. OF PAIRS	LEAD STYLE	PLATING OPTION	TYPE	A	OTHER OPTIONS	"X"R
	-026, -052, -078 (52 total pins per bank = -D)	-02.0 = 2 mm Body Height Not available with -054 & -078 Positions)	-L = 10 μ" (0.25 μm) Gold on contact, Matte Tin on tail	-D = Single-Ended		-GP = Guide Post	Leave blank for Tray Packaging
	-018, -036, -054 (18 pairs per bank = -D-DP)	-05.0 = 5 mm Body Height	-S = 30 μ" (0.76 μm) Gold on contact, Matte Tin on tail	-D-DP = Differential Pair		-K = (5.00 mm) .197" DIA Polyimide Film Pick & Place Pad	-TR = Tape & Reel
		-07.0 = 7 mm Body Height					-FR = Full Reel Tape & Reel (must order maximum quantity per reel; contact Samtec for quantity breaks)

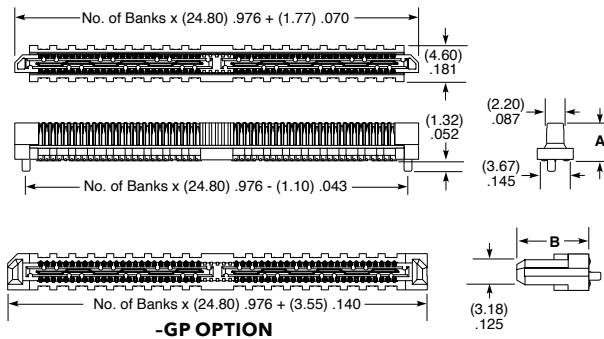

LEAD STYLE	A	B
-02	(4.81) .189	(6.12) .241
-05	(7.81) .307	(9.12) .359
-07	(9.78) .385	(11.12) .438

View complete specifications at: samtec.com?QRM8

PROCESSING

- Lead-Free Solderable:** Yes
- SMT Lead Coplanarity:** (0.10 mm) .004" max (018-026) (0.15 mm) .006" max (036-078)*
- *(.004" stencil solution may be available; contact ipg@samtec.com)
- Board Stacking:** For applications requiring more than two connectors contact ipg@samtec.com

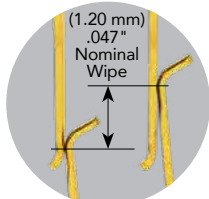

QRF8	PINS PER ROW NO. OF PAIRS	LEAD STYLE	PLATING OPTION	TYPE	A	OTHER OPTIONS	"X"R
	-026, -052, -078 (52 total pins per bank = -D)	-05.0 = 5 mm Body Height	-L = 10 μ" (0.25 μm) Gold on contact, Matte Tin on tail	-D = Single-Ended		-GP = Guide Post	Leave blank for Tray Packaging
	-018, -036, -054 (18 pairs per bank = -D-DP)	-07.0 = 7 mm Body Height	-S = 30 μ" (0.76 μm) Gold on contact, Matte Tin on tail	-D-DP = Differential Pair		-K = (5.00 mm) .197" DIA Polyimide Film Pick & Place Pad	-TR = Tape & Reel (Not available with -054 & -078 positions)
							-FR = Full Reel Tape & Reel (must order max. quantity per reel; contact Samtec for quantity breaks) (Not available with -054 & -078 positions)

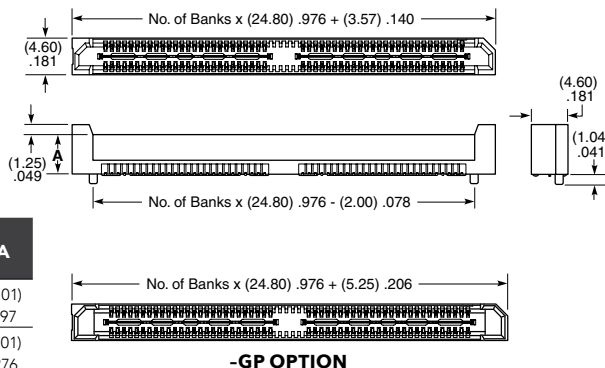

LEAD STYLE	A
-05	(5.01) .197
-07	(7.01) .276

QRF8 LEAD STYLE	QRM8 LEAD STYLE		
	-02.0	-05.0	-07.0
-05	(7.00) .276	(10.00) .394	(12.00) .472
-07	(9.00) .354	(12.00) .472	(14.00) .551

*Processing conditions will affect mated height. See SO Series for board space tolerances.

View complete specifications at: samtec.com?QRF8



HIGH-SPEED SIGNAL & POWER COMBINATIONS

Q2™ Rugged Signal/Power

- Integral power/ground plane rated for up to 15.7 Amps
- Optional integral power pins rated at 4 Amps
- Wide variety of standard high-speed mating cable assemblies
- Combination signal/power cable assemblies
- 0.635 mm pitch with choice of stack heights
- Rugged contact system with increased insertion depth
- See QMS/QFS Series



Integral Power /
Ground Plane



Maximum
Insertion Depth

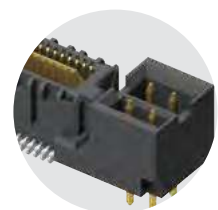

Optional Power Pins



Q Strip® High-Speed Signal/Power

- Integral power/ground plane rated for up to 25 Amps
- Wide variety of standard high-speed mating cables
- Low profile (5 mm) to elevated (25 mm) stack heights
- Choice of pitches: QTH/QSH Series (0.50 mm pitch), QTS/QSS Series (0.635 mm pitch), and QTE/QSE Series (0.80 mm pitch)

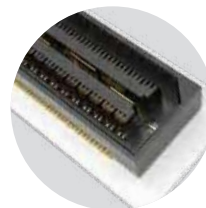

Single-Ended or
Differential Pair

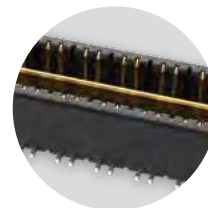

Surface Mount or
Through-Hole Power
Planes



Low Profile to
Elevated Stack
Heights



Q Rate® Slim Body High-Speed Signal/Power

- Widely accepted industry standard power/ground plane rated for up to 8.5 Amps
- Signal integrity optimized Edge Rate® contact is robust when “zippered” during unmating
- Slim 4.60 mm body width on 0.80 mm pitch
- 7 mm to 14 mm stack heights
- See QRM8/QRF8 Series

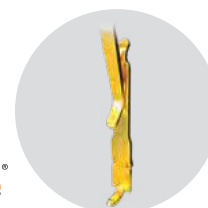

Edge Rate®
Contact System



Integral Power /
Ground Plane



RIGHT-ANGLE & EDGE MOUNT HIGH-SPEED GROUND PLANE CONNECTORS

- Right-Angle and Edge Mount designs for coplanar and perpendicular mating
- Q Strip® Right-Angle High-Speed Connectors on 0.50 mm & 0.635 mm pitches
- Q2™ Right-Angle & Edge Mount Rugged High-Speed Connectors on 0.635 mm pitch
- Q Rate® Right-Angle Slim Body High-Speed Connectors on 0.80 mm pitch
- Visit samtec.com/QSeries for complete specifications and ordering information



Q STRIP® HIGH-SPEED GROUND PLANE CONNECTORS

(0.50 mm) .0197" PITCH RIGHT-ANGLE GROUND PLANE HEADERS & SOCKETS



QTH-RA
Board Mates:
QSH

QSH-RA
Board Mates:
QTH

SERIES	PINS PER ROW NO. OF PAIRS	01	PLATING	TYPE	RA	OTHER OPTION
QTH Header	-030, -060, -090 -D = (60 total pins per bank)		-F = Gold Flash on contact, Matte Tin on tails	-D = Single-Ended		-PGP = Plastic Guide Post (QTH only)
QSH Socket	-020, -040, -060 -D-DP = (20 pairs per bank)		-L = 10 μ" (0.25 μm) Gold contact, Matte Tin on tails	-D-DP = Differential Pair		-GP = Guide Post Holes (QSH only)
						-K = Polyimide film Pick & Place Pad

View complete specifications at: samtec.com?QTH-RA or samtec.com?QSH-RA

(0.635 mm) .025" PITCH RIGHT-ANGLE GROUND PLANE HEADERS & SOCKETS



QTS-RA
Board Mates:
QSS

QSS-RA
Board Mates:
QTS

Cable Mates:
SQCD

SERIES	POSITIONS PER ROW	01	PLATING	D	RA	WT	OTHER OPTION
QTS Header	-025, -050, -075 (50 total Positions per bank)		-F = Gold Flash on Signal Pins and Ground Plane, Matte Tin on tails			-WT = Weld Tab (N/A with -025 Positions)	-SP = Solder Pin (QTS only)
QSS Socket			-L = 10 μ" (0.25 μm) Gold on Signal Pins and Ground Plane, Matte Tin on tails				

View complete specifications at: samtec.com?QTS-RA or samtec.com?QSS-RA

Note:
Some lengths, styles and options are non-standard, non-returnable.

Q2™ HIGH-SPEED GROUND PLANE CONNECTORS

(0.635 mm) .025" PITCH RIGHT-ANGLE GROUND PLANE HEADERS & SOCKETS



QMS-RA
Board Mates:
QFS

QFS-RA
Board Mates:
QMS

SERIES	PINS PER ROW NO. OF PAIRS	01	PLATING	TYPE	RA	MG	OTHER OPTION	PACKAGING
QMS Header	-026, -052, -078 -D = (52 total pins per bank)		-SL = 10 μ" (0.25 μm) Gold on Signal Pins and Ground Plane, Matte Tin on tails	-D = Single- Ended -D-DP = Differential Pair		-MG = Metal Guide Post (QMS only)	-K = Polyimide film Pick & Place Pad	Leave blank for Tray Packaging -TR = Tape & Reel (-016, -026, -032 & -052 only) -FR = Full Reel Tape & Reel (must order max. quantity per reel; contact Samtec for quantity breaks) (-016, -026, -032 & -052 only)
QFS Socket	-016, -032, -048 -D-DP = (16 pairs per bank)							

View complete specifications at: samtec.com?QMS-RA or samtec.com?QFS-RA

(0.635 mm) .025" PITCH EDGE MOUNT GROUND PLANE HEADERS & SOCKETS



QMS-EM
Board Mates:
QFS

QFS-EM
Board Mates:
QMS

SERIES	POSITIONS PER ROW	01	PLATING	D	EM2	END OPTION	PACKAGING
QMS Header	-026, -052, -078		-SL = 10 μ" (0.25 μm) Gold on Signal Pins and Ground Plane, Matte Tin on tails			-PC4 = 4 Power Pins per end (QMS only)	Leave blank for Tray Packaging -TR = Tape & Reel (-026 & -052 only) -FR = Full Reel Tape & Reel (must order max. quantity per reel; contact Samtec for quantity breaks) (-026 & -052 only)
QFS Socket							

View complete specifications at: samtec.com?QMS-EM or samtec.com?QFS-EM

Q RATE® SLIM BODY HIGH-SPEED GROUND PLANE CONNECTORS

(0.80 mm) .0315" PITCH RIGHT-ANGLE SLIM BODY GROUND PLANE HEADERS & SOCKETS

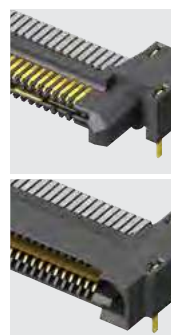

QRM8-RA
Board Mates:
QRF8
(-GP Required)

QRF8-RA
Board Mates:
QRM8
(-GP Required)

SERIES	POSITIONS PER ROW	01	PLATING	RA	GP	OPTION	PACKAGING
QRM8 Header	-026, -052, -078 (52 total positions per bank)		-L = 10 μ" (0.25 μm) Gold contact, Matte Tin on tails		-GP = Guide Post (Requires -GP on mating connector)	-K = (7.00 mm) .275" DIA Polyimide film Pick & Place Pad (-052 only)	Leave blank for Tray Packaging -TR = Tape & Reel (-026, -052 only) -FR = Full Reel Tape & Reel (must order max. quantity per reel; contact Samtec for quantity breaks) (-026 & -052 only)
QRF8 Socket							

Note:
Some lengths, styles and options
are non-standard, non-returnable.

View complete specifications at: samtec.com?QRM8-RA or samtec.com?QRF8-RA

RUGGED HIGH-SPEED STRIPS



NRZ	PAM4
28 Gbps	56 Gbps

FEATURES & BENEFITS

Edge Rate® rugged high-speed connector strips are designed for high-speed, high cycle applications, and enabled by Samtec's signal integrity-optimized Edge Rate® contact system.

- Up to 1.5 mm contact wipe for a reliable connection
- 20 to 200 positions
- Choice of 0.50 mm, 0.635 mm or 0.80 mm pitch
- 0.50 mm pitch system offers up to 40% PCB space savings vs. 0.80 mm pitch
- 0.635 mm pitch system with extremely slim 2.5 mm body width
- Rugged latching, extended guide posts and 360° shielding
- Severe Environment Testing qualified (ERM8/ERF8); aligns with MIL-DTL-55302. Visit samtec.com/set



Signal integrity-optimized Edge Rate® contact system reduces broadside coupling



Rugged 360° shielding reduces EMI

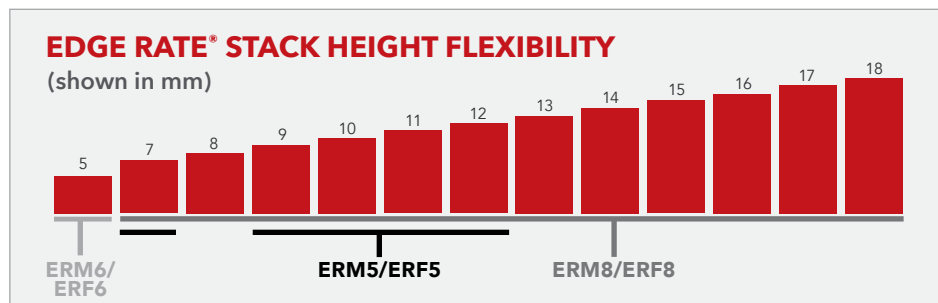

KEY SPECIFICATIONS

SERIES	PITCH	INSULATOR MATERIAL	TERMINAL MATERIAL	PLATING	OPERATING TEMP RANGE	CURRENT RATING	VOLTAGE RATING	LEAD-FREE SOLDERABLE
ERM5 / ERF5	0.50 mm	Black LCP	Phosphor Bronze or BeCu (ERM5), BeCu (ERF5)	Au or Sn over 50 μ" (1.27 μm) Ni	-55 °C to +125 °C	1.5 A	190 VAC	Yes
ERM6 / ERF6	0.635 mm		Copper Alloy			1.4 A	155 VAC	
ERM8 / ERF8	0.80 mm		Phosphor Bronze or BeCu (ERM8), BeCu (ERF8)			1.4 A	225 VAC	

(0.50 mm) .0197" PITCH • RUGGED HIGH-SPEED STRIPS

SERIES	POSITIONS PER ROW	LEAD STYLE	PLATING OPTION	DV	PICK & PLACE PAD	"X"R
ERM5 = Header	-010, -020, -030, -040, -050, -060, -070, -075	-02.0 = 2 mm Body Height (ERM5 only)	-L = 10 μ" (0.25 μm) Gold on contact, Matte Tin on Tail		(required in callout) -K = (3.50 mm) .138" DIA Polyimide Film Pick & Place Pad (ERM5 -04.0 -05.0 and Lead Style only) -P = (6.00 mm) .236" DIA Polyimide Film Pick & Place Pad (ERF5 only)	-TR = Tape & Reel -FR = Full Reel Tape & Reel (must order maximum quantity per reel; contact Samtec for quantity breaks)
ERF5 = Socket		-04.0 = 4 mm Body Height (ERM5 only)				
		-05.0 = 5 mm Body Height				
		-07.0 = 7 mm Body Height (ERF5 only & Available up to 50 Pos. only)				

ERM5
Board Mates:
ERF5

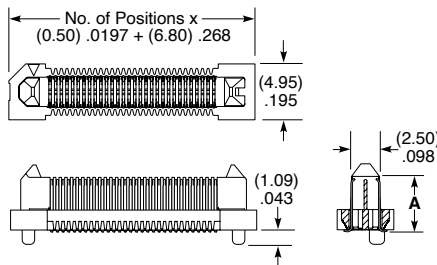
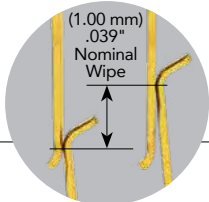
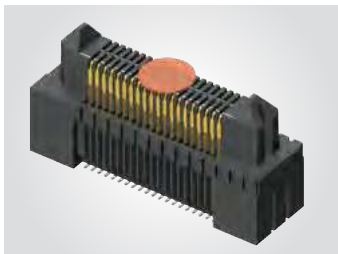

LEAD STYLE	A (ERM5)	B (ERF5)
-02.0	(4.84) .191	N/A
-04.0	(6.84) .269	N/A
-05.0	(7.84) .309	(4.91) .193
-07.0	N/A	(6.91) .272

ERF5
Board Mates:
ERM5

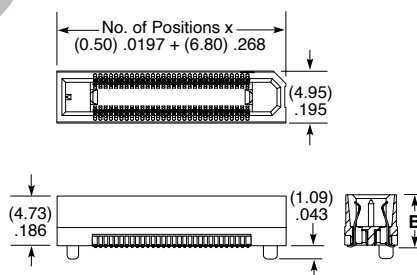

ERM5 LEAD STYLE	MATED HEIGHT*	
	ERF5 LEAD STYLE -05.0	ERF5 LEAD STYLE -07.0
-02.0	(7.00) .276	(9.00) .354
-04.0	(9.00) .354	(11.00) .433
-05.0	(10.00) .394	(12.00) .472

*Processing conditions will affect mated height.

View complete specifications at: samtec.com?erm5 or samtec.com?erf5

ERF5	POSITIONS PER ROW	01	PLATING OPTION	D	RA	"X"R
------	-------------------	----	----------------	---	----	------

Right-Angle Socket

-010, -020, -030, -040, -050

-L
= 10 μ" (0.25 μm) Gold on contact, Matte Tin on tail

-TR
= Tape & Reel

-FR
= Full Reel Tape & Reel (must order maximum quantity per reel; contact Samtec for quantity breaks)

ERF5-RA
Board Mates:
ERM5

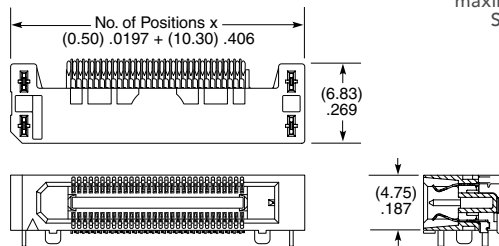

Note:
Some lengths, styles and options are non-standard, non-returnable.

View complete specifications at: samtec.com?erf5-ra

(0.635 mm) .025" PITCH • RUGGED HIGH-SPEED HEADERS & SOCKETS

ERM6	POSITIONS PER ROW	01.5	PLATING OPTION	DV	A	OPTION	K	"X"R
-------------	--------------------------	-------------	-----------------------	-----------	----------	---------------	----------	-------------

**-10, -20, -30,
-40, -50, -60**
(Standard Sizes)

-L
= 10 μ" (0.25 μm)
Gold on contact,
Matte Tin on tail

(Leave Blank for
No Weld Tab)

-WT
= Weld Tab

-TR
= Tape & Reel

-FR
= Full Reel Tape & Reel
(must order maximum quantity
per reel; contact Samtec for
quantity breaks)

ERM6
Board Mates:
ERF6

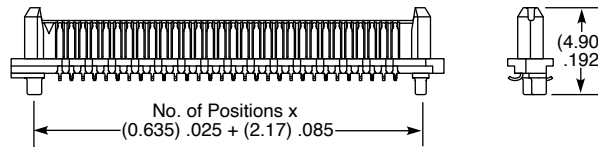
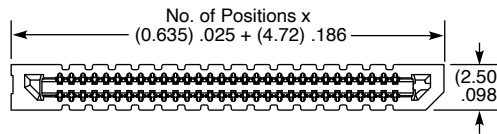
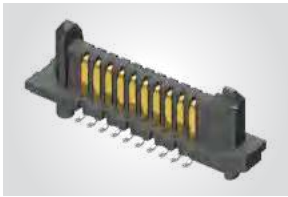

MATED HEIGHT*

ERF6 LEAD STYLE	ERM6 LEAD STYLE
	-01.5
-03.5	(5.00) .197

*Processing conditions will affect mated height.

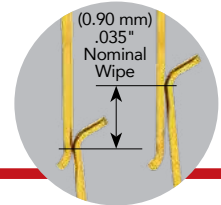

View complete specifications at: samtec.com?ERM6

ERF6	POSITIONS PER ROW	03.5	PLATING OPTION	DV	A	OPTION	K	"X"R
-------------	--------------------------	-------------	-----------------------	-----------	----------	---------------	----------	-------------

**-10, -20, -30,
-40, -50, -60**
(Standard Sizes)

-L
= 10 μ" (0.25 μm)
Gold on contact,
Matte Tin on tail

(Leave Blank for
No Weld Tab)

-WT
= Weld Tab

-TR
= Tape & Reel

-FR
= Full Reel Tape & Reel
(must order maximum quantity
per reel; contact Samtec for
quantity breaks)

ERF6
Board Mates:
ERM6

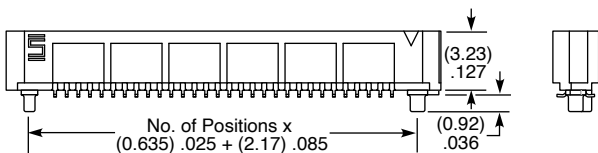
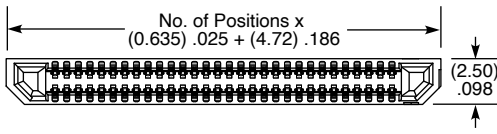

MATED HEIGHT*

ERF6 LEAD STYLE	ERM6 LEAD STYLE
	-01.5
-03.5	(5.00) .197

*Processing conditions will affect mated height.

Notes:
Kapton pad and tape & reel
packaging are standard.

Some lengths, styles and
options are non-standard,
non-returnable.

View complete specifications at: samtec.com?ERF6

(0.80 mm) .0315" PITCH • RUGGED HIGH-SPEED HEADERS & SOCKETS

TYPE	POSITIONS PER ROW	LEAD STYLE	PLATING OPTION	DV	OPTIONS	"X"R
------	-------------------	------------	----------------	----	---------	------

ERM8
= Header
ERF8
= Socket

-005, -010, -011, -013, -020, -025, -030, -035, -040, -049, -050, -060, -070, -075, -100

(100 Position Only Available with ERM8-09.0 & ERF8-05.0 Lead Styles; -L or -EGP N/A)

SPECIFY LEAD STYLE FROM CHART

-L
= 10 μ" (0.25 μm)
Gold on contact, Matte Tin on tail
-S
= 30 μ" (0.76 μm)
Gold on contact, Matte Tin on tail

-DS
= Differential Pair (ERM8 -05.0 Lead Style with -010, -013, -025, -049 Positions only) (-P not available)
-L
= Latching (ERM8 -03.0, -05.0 & -09.0 Lead Styles only & -EGP Option not available) (ERF8 -05.0, -07.0 & -09.0 Lead Style only, -L & -EGP Options not available)

-TR
= Tape & Reel (100 Positions N/A)
-FR
= Full Reel Tape & Reel (must order maximum quantity per reel; contact Samtec for quantity breaks) (100 Positions N/A)

ERM8
Board Mates:
ERF8

Cable Mates:
ERCD, ERDP

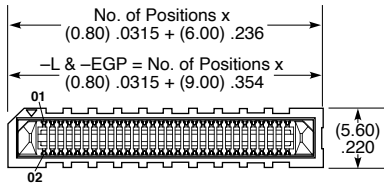
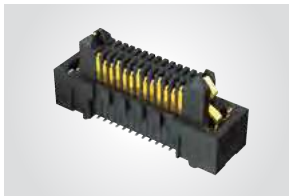

ERM8 LEAD STYLE	A	B
-02.0	(5.97) .235	N/A
-03.0	(6.97) .274	(1.60) .063
-05.0	(8.91) .351	(1.17) .046
-08.0	(11.91) .469	N/A
-09.0	(12.91) .508	(1.60) .063

-EGP
= Extended Guide Post (ERM8 -05.0 & ERF8 -07.0 Lead Style Only & -L Option not available)
-DSP
= Differential Pair with Extended Guide Post (ERM8 -05.0 Lead Style with -013 and -025 Positions only)
-K
= Polyimide Film Pick & Place Pad (-02.0 Lead Style not available)
-P
= Pick & Place Pad (ERM8 -02.0, -03.0 & -05.0 Lead Styles only) (-DS not available)

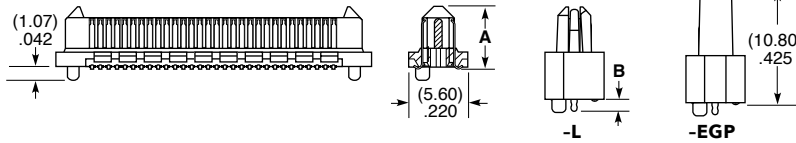

View complete specifications at: samtec.com?ERM8

ERF8
Board Mates:
ERM8

ERF8
Cable Mates:
ERCD, ERDP

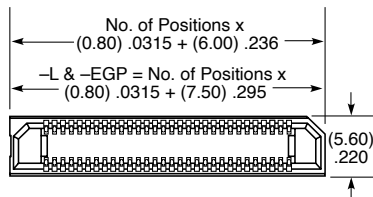
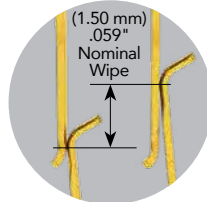

ERF8 LEAD STYLE	C	D
-05.0	(5.34) .210	(1.60) .063
-07.0	(7.25) .285	(1.17) .046
-09.0	(9.34) .368	(1.60) .063

ERM8 LEAD STYLE	MATED HEIGHT*		
	ERF8 LEAD STYLE -05.0	-07.0	-09.0
-02.0	(7.00) .276	(9.00) .354	(11.00) .433
-03.0	(8.00) .315	(10.00) .394	(12.00) .472
-05.0	(10.00) .394	(12.00) .472	(14.00) .551
-08.0	(13.00) .512	(15.00) .591	(17.00) .669
-09.0	(14.00) .551	(16.00) .630	(18.00) .709

*Processing conditions will affect mated height.

Notes:
Severe Environment Testing qualified; aligns with MIL-DTL-55302. Visit samtec.com/set

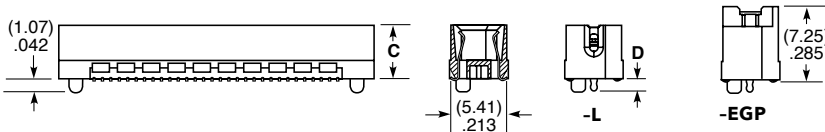

Some lengths, styles and options are non-standard, non-returnable.

View complete specifications at: samtec.com?ERF8

(0.80 mm) .0315" PITCH • RIGHT-ANGLE & EDGE MOUNT HIGH-SPEED HEADERS

ERM8	POSITIONS PER ROW	01	PLATING OPTION	D	RA	OPTIONS	"X"R
------	-------------------	----	----------------	---	----	---------	------

Right-Angle Terminal	-010, -013, -020, -025, -030, -040, -049, -050, -060, -070, -075		-L = 10 μ" (0.25 μm) Gold on contact area, Matte Tin on tail			-K = (6.00 mm) .236" DIA Polyimide Film Pick & Place Pad -L = Latching -DS = Differential Pair (-013, -025 Positions only) (Hot Swap)	-TR = Tape & Reel -FR = Full Reel Tape & Reel (must order maximum quantity per reel; contact Samtec for quantity breaks)
----------------------	--	--	--	--	--	---	---

ERM8-RA
Board Mates: ERF8
Cable Mates: ERCD

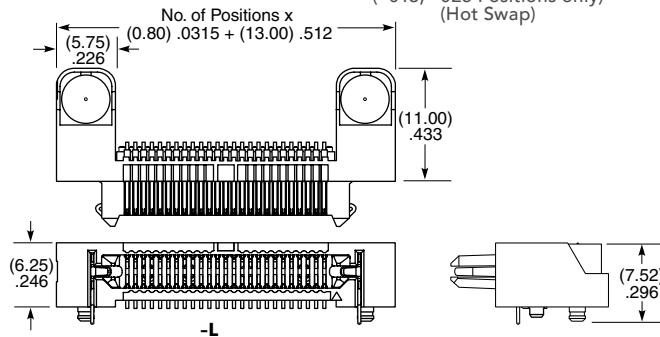
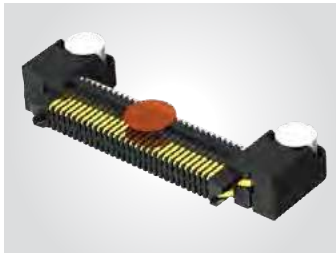

View complete specifications at: samtec.com?ERM8-RA

ERM8	POSITIONS PER ROW	01	PLATING OPTION	D	EM2	OPTIONS	"X"R
------	-------------------	----	----------------	---	-----	---------	------

Edge Mount Terminal	-010, -013, -020, -025, -030, -040, -049, -050, -060, -070, -075		-L = 10 μ" (0.25 μm) Gold on contact area, Matte Tin on tail		= (1.60 mm) .062" Thick PCB	-L = Latching (Mates to ERF8 Lead Style -05.0 or -RA Only) -DS = Differential Pair (-013 & -025 Positions only) (Hot Swap) -EGPS = Extended Guide Post Shield (-010, -020, -025, -030 Positions Only) -DSS = Differential Pair + Extended Guide Post Shield (-025 Positions Only) (Hot Swap)	-TR = Tape & Reel -FR = Full Reel Tape & Reel (must order maximum quantity per reel; contact Samtec for quantity breaks)
---------------------	--	--	--	--	-----------------------------	---	---

ERM8-EM
Board Mates: ERF8
Cable Mates: ERCD

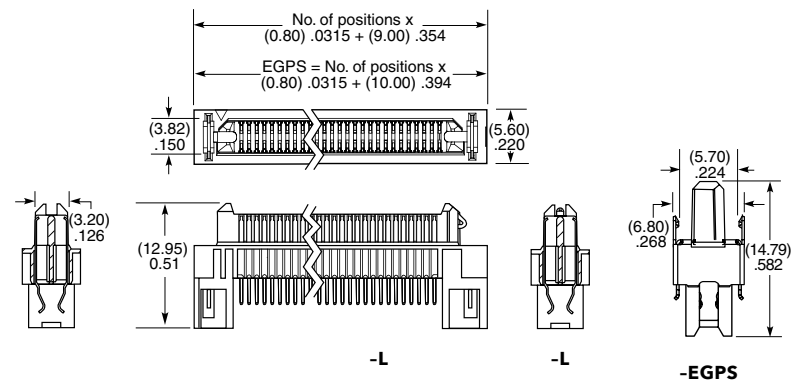
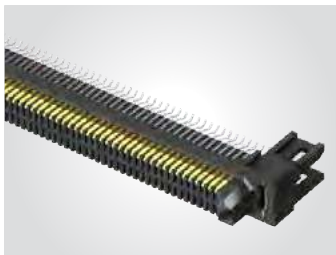

Note:
Some lengths, styles and options are non-standard, non-returnable.

View complete specifications at: samtec.com?ERM8-EM

(0.80 mm) .0315" PITCH • RIGHT-ANGLE & EDGE MOUNT HIGH-SPEED SOCKETS

ERF8	POSITIONS PER ROW	01	PLATING OPTION	D	RA	OPTIONS	"X"R
------	-------------------	----	----------------	---	----	---------	------

Right-Angle Socket

-010, -013, -020,
-025, -030, -040,
-049, -050, -060,
-070, -075

-L
= 10 μ" (0.25 μm)
Gold on contact
area, Matte Tin
on tail

-L
= Latching
(N/A with -EGP Option)

-EGP
= Extended Guide Post
(N/A with -L Option)

-TR
= Tape & Reel

-FR
= Full Reel
Tape & Reel
(must order maximum
quantity per reel;
contact Samtec for
quantity breaks)

ERF8-RA
Board Mates:
ERM8
Cable Mates:
ERCD, ERDP

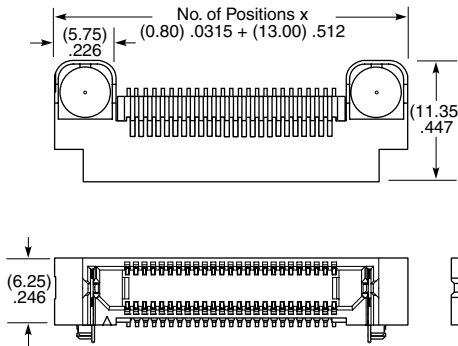

View complete specifications at: samtec.com?ERF8-RA

ERF8	POSITIONS PER ROW	01	PLATING OPTION	D	EM2	OPTIONS	"X"R
------	-------------------	----	----------------	---	-----	---------	------

Edge Mount Socket

-010, -013,
-020, -025,
-030, -040,
-049, -050,
-060, -070,
-075

-L
= 10 μ" (0.25 μm)
Gold on contact
area, Matte Tin
on tail

= (1.60 mm)
.062" Thick
PCB

-EGPS
= Extended Guide Post Shield
(-010, -020, -025, -030 Pos. only)

-TR
= Tape & Reel

-FR
= Full Reel Tape & Reel
(must order maximum
quantity per reel;
contact Samtec for
quantity breaks)

ERF8-EM
Board Mates:
ERM8

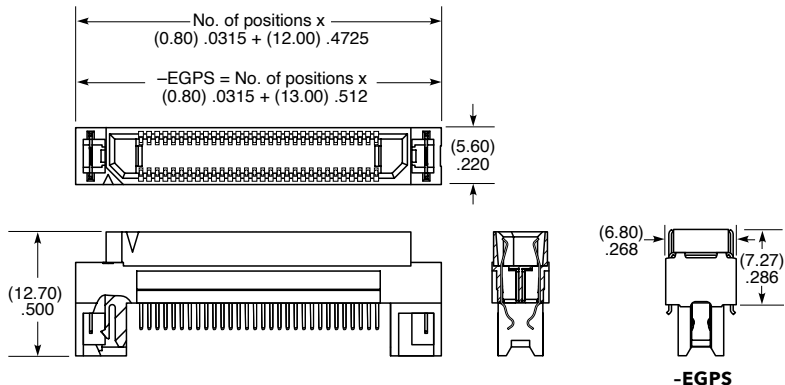

Note:
Some lengths, styles and
options are non-standard,
non-returnable.

View complete specifications at: samtec.com?ERF8-EM

(0.80 mm) .0315" PITCH • SHIELDED HIGH-SPEED HEADERS & SOCKETS

TYPE	POSITIONS PER ROW	LEAD STYLE	PLATING OPTION	DV	OPTIONS	"X"R
ERM8 = Shielded Terminal	-010, -020, -025, -030	-02.0 = 2 mm (ERM8 with -S only)	-L = 10 μ" (0.25 μm) Gold on contact, Matte Tin on tail		-S = Shield (Lead Styles: ERM8 -02.0 only; ERF8 -05.0 only)	-TR = Tape & Reel
ERF8 = Shielded Socket		-05.0 = 5 mm (ERF8 with -S & ERM8 with -EGPS & -DSS only)	-S = 30 μ" (0.76 μm) Gold on contact, Matte Tin on tail		-EGPS = Extended Guide Post Shield (Lead Styles: ERM8 -05.0 & -09.0 only; ERF8 -07.0 only)	-FR = Full Reel Tape & Reel (must order maximum quantity per reel; contact Samtec for quantity breaks)
		-07.0 = 7 mm (ERF8 with -EGPS only)			-DSS = Differential Pair with Extended Guide Post Shield (ERM8 only, with -05.0 & -09.0 Lead Styles, -10 & -025 Positions only)	
		-09.0 = 9 mm (ERM8 with -EGPS & -DSS only)			-K = Polyimide Film Pick & Place Pad (-02.0 Lead Style N/A)	
					-P = Pick & Place Pad (ERM8 -02.0 & -05.0 Lead Styles only)	

ERM8-S Board Mates:
See "Mated Height" Chart

(Note: ERF8-S does not mate with ERM8-EGPS)

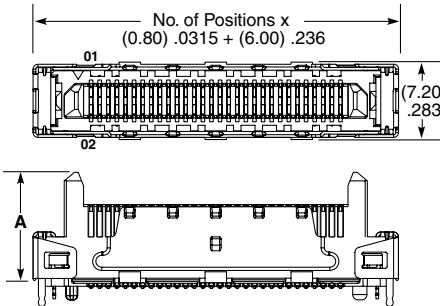

LEAD STYLE	A	B
-05.0	(9.87) .389	(10.81) .425
-09.0	(13.87) .546	(14.81) .583

-S OPTION -EGPS OR -DSS OPTION

View complete specifications at: samtec.com?ERM8

ERF8-S Board Mates:
See "Mated Height" Chart

(Note: ERM8-EGPS does not mate with ERF8-S)

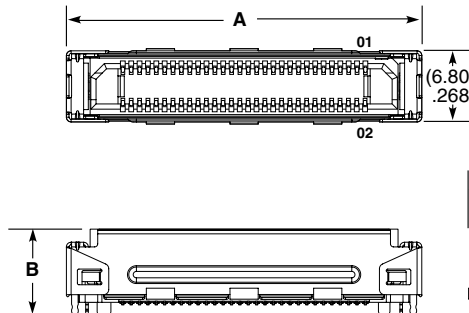

LEAD STYLE	B (-S)	B (-EGPS)
-05.0	(5.90) .232	N/A
-07.0	N/A	(7.42) .292

Notes:
Severe Environment Testing qualified; aligns with MIL-DTL-55302. Visit samtec.com/set

Some lengths, styles and options are non-standard, non-returnable.

POSITIONS PER ROW	A
-010	(18.00) .71
-020	(26.00) 1.02
-025	(30.00) 1.18
-030	(34.00) 1.34

-S OPTION

View complete specifications at: samtec.com?ERF8

ULTRA MICRO INTERCONNECTS

SPACE SAVING DESIGNS • RUGGED HERMAPHRODITIC • ULTRA FINE PITCH



54-56

RAZOR BEAM™

0.50 mm Pitch Hermaphroditic Connectors (LSHM)	54-55
0.635 mm Pitch Hermaphroditic Connectors (LSS)	56
0.80 mm Pitch Hermaphroditic Connectors (LSEM)	56

57-59

MICRO BLADE & BEAM STRIPS

0.40 mm Pitch Low Profile Strips (ST4, SS4)	57
0.50 mm Pitch Low Profile Strips (ST5, SS5, SLH, TLH)	58-59

FINE PITCH SELF MATING CONNECTORS

(0.50 mm) .0197" PITCH

FEATURES & BENEFITS

- Ten stack height options from 5.00 mm to 12.00 mm
- 0.50 mm, 0.635 mm or 0.80 mm pitches
- Audible click when mated
- Mating and unmating forces approximately 4-6x greater than typical micro pitch connectors
- Self-mating system reduces inventory cost
- Parallel, perpendicular and coplanar systems
- Shielded and lubricated options
- Severe Environment Testing qualified (LSHM); aligns with MIL-DTL-55302. Visit samtec.com/set

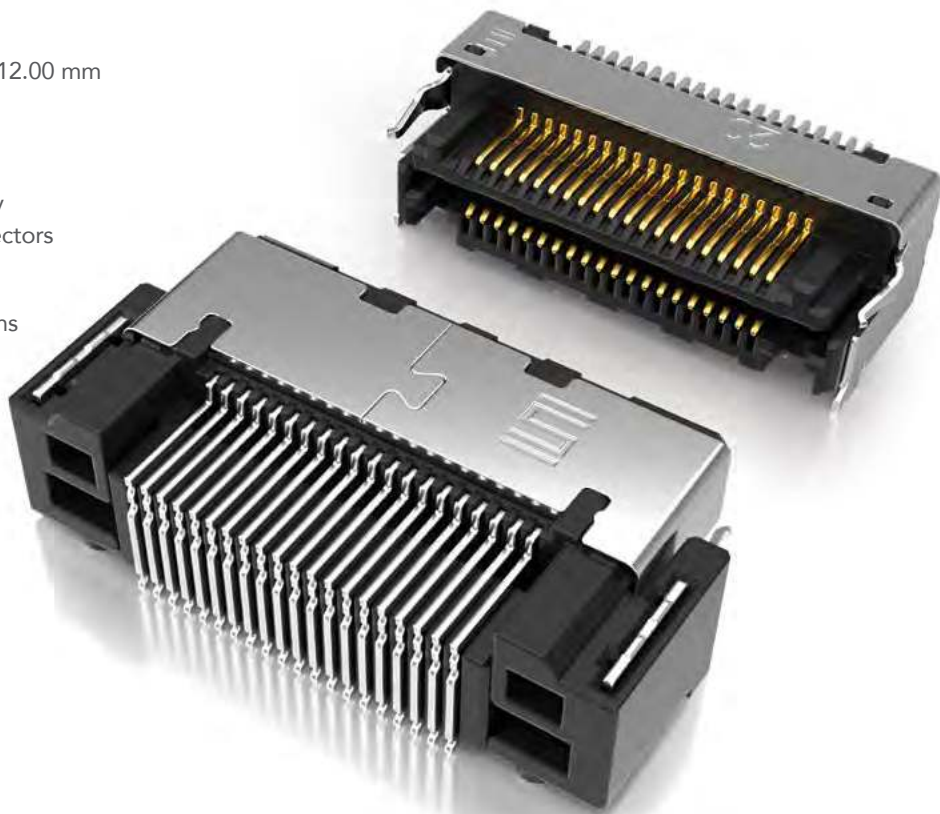

SLIM BODY DESIGNS (40 total positions each)

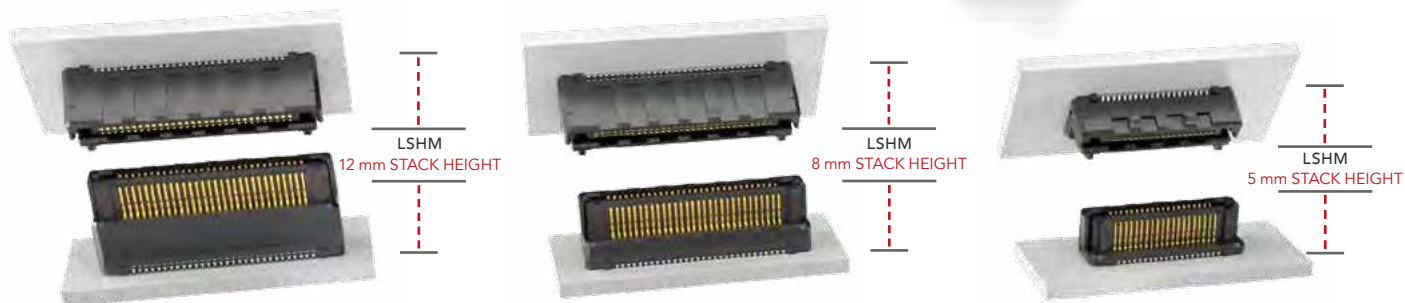

KEY SPECIFICATIONS

INSULATOR MATERIAL	CONTACT MATERIAL	PLATING	OPERATING TEMP RANGE	CURRENT RATING	SMT COPLANARITY	LEAD-FREE SOLDERABLE
Black LCP	Phosphor Bronze	Au or Sn over 50 μ" (1.27 μm) Ni	-55 °C to +125 °C	LSHM: 2.0 A per pin LSS: 1.7 A per pin LSEM: 1.8 A per pin	(0.10 mm) .004" max	Yes

(0.50 mm) .0197" PITCH • RUGGED HERMAPHRODITIC CONNECTORS

LSHM	1	NO. PINS PER ROW	LEAD STYLE	PLATING OPTION	TAIL OPTION	A	SHIELD OPTION	K	"X"R
		05, 10, 20, 30, 40, 50	(Vertical) Specify LEAD STYLE from chart (Right-angle) -01 = Standard (Right-angle) -L1 = Lubricated	-F = Gold flash on contact, Matte Tin on tail -L = 10 μ" (0.25 μm) Gold on contact, Matte Tin on tail	-DV = Vertical -DH = Right-angle (Lead style -01 & -L1 only) -RH = Reverse Right-angle (Lead style -01 & -L1 only)		-S = With Shield -N = Without Shield	-K = (3.50 mm) .138" DIA Polyimide film Pick & Place Pad	-TR = Tape & Reel -FR = Full Reel Tape & Reel (must order maximum quantity per reel; contact Samtec for quantity breaks)

LSHM

Board Mates:
LSHM
Cable Mates:
HLCD

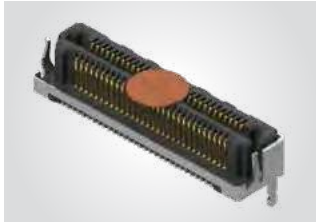

LEAD STYLE (STANDARD)	LEAD STYLE (LUBRICATED)	A	B
-02.5	-L2.5	(3.95) .156	(1.00) .039
-03.0	-L3.0	(4.45) .175	(1.50) .059
-04.0	-L4.0	(5.45) .215	(2.50) .098
-06.0	-L6.0	(7.45) .293	(4.50) .177

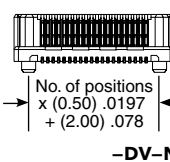
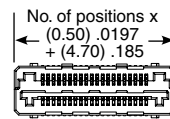

-DV-N

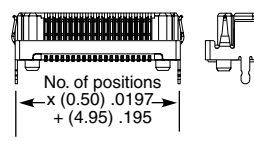
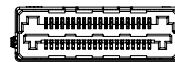

-DV-S

LEAD STYLE	MATED HEIGHT *
-02.5 & -02.5	(5.00) .196
-02.5 & -03.0	(5.50) .217
-03.0 & -03.0	(6.00) .236
-02.5 & -04.0	(6.50) .256
-03.0 & -04.0	(7.00) .276
-04.0 & -04.0	(8.00) .315
-02.5 & -06.0	(8.50) .335
-03.0 & -06.0	(9.00) .354
-04.0 & -06.0	(10.00) .394
-06.0 & -06.0	(12.00) .472

*Processing conditions will affect mated height.

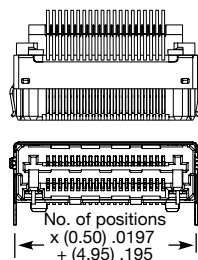

-DH-S

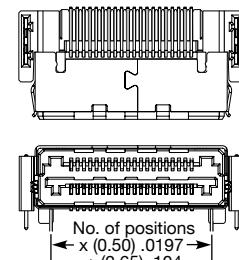
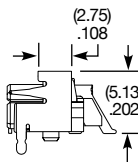

-RH-S

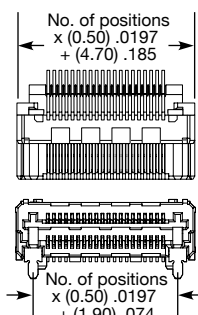
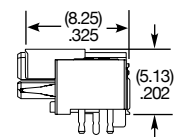

-DH-N

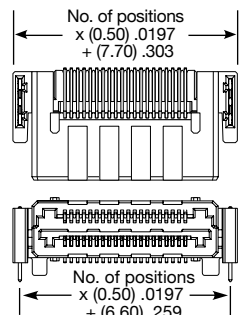
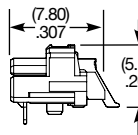

-RH-N

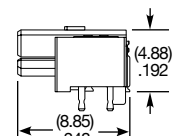

Notes:
Severe Environment Testing qualified; aligns with MIL-DTL-55302. Visit samtec.com/set

Some lengths, styles and options are non-standard, non-returnable.

View complete specifications at: samtec.com?LSHM

(0.635 mm) .025" PITCH • RUGGED HERMAPHRODITIC CONNECTORS

LSS - **1** **NO. PINS PER ROW** - **LEAD STYLE** - **PLATING OPTION** - **DV** - **A** - **OPTION**

10, 20, 30, 40, 50

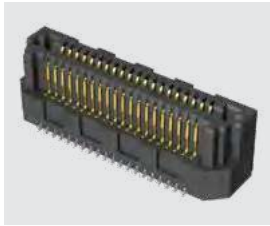

Specify **LEAD STYLE** from chart

-F
= Gold flash on contact, Matte Tin on tail

-L
= 10 μ" (0.25 μm) Gold on contact, Matte Tin on tail

-K
= (3.50 mm) .138" DIA Polyimide film Pick & Place Pad

-TR
= Tape & Reel

-FR
= Full Reel Tape & Reel (must order maximum quantity per reel; contact Samtec for quantity breaks)

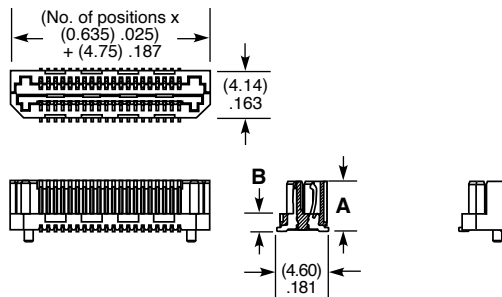

LEAD STYLE	A	B
-01	(4.45) .1752	(1.59) .0628
-02	(7.45) .2933	(4.59) .1808
-03	(5.45) .2146	(2.59) .1021

LEAD STYLE	MATED HEIGHT *
-01 & -01	(6.00) .236
-01 & -03	(7.00) .276
-03 & -03	(8.00) .315
-01 & -02	(9.00) .354
-02 & -03	(10.00) .394
-02 & -02	(12.00) .472

*Processing conditions will affect mated height.

View complete specifications at: samtec.com?LSS

(0.80 mm) .0315" PITCH • RUGGED HERMAPHRODITIC CONNECTORS

LSEM - **1** **NO. PINS PER ROW** - **LEAD STYLE** - **PLATING OPTION** - **TAIL OPTION** - **A** - **N** - **K** - **"X"R**

20, 30, 40, 50



Specify **LEAD STYLE** from chart

-F
= Gold flash on contact, Matte Tin on tail

-L
= 10 μ" (0.25 μm) Gold on contact, Matte Tin on tail

-DV
= Vertical

-DH
= Right-angle (Lead style -01 only)

-K
= (3.50 mm) .138" DIA Polyimide film Pick & Place Pad

-TR
= Tape & Reel

-FR
= Full Reel Tape & Reel (must order maximum quantity per reel; contact Samtec for quantity breaks)

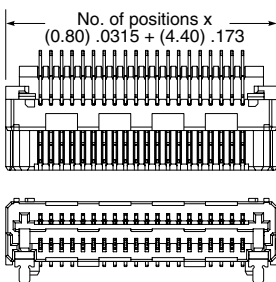

LEAD STYLE	A	B
-01 (-DH only)	N/A	NA
-03.0	(4.45) .175	(1.50) .059
-04.0	(5.45) .215	(2.50) .098
-06.0	(7.45) .293	(4.50) .177

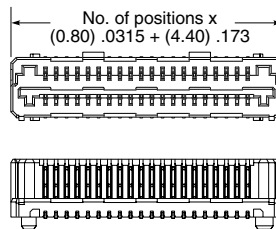

LEAD STYLE	MATED HEIGHT *
-03.0 & -03.0	(6.00) .236
-03.0 & -04.0	(7.00) .276
-04.0 & -04.0	(8.00) .315
-03.0 & -06.0	(9.00) .354
-04.0 & -06.0	(10.00) .394
-06.0 & -06.0	(12.00) .472

*Processing conditions will affect mated height.

Note: Some lengths, styles and options are non-standard, non-returnable.

-DH

-DV

View complete specifications at: samtec.com?LSEM

MICRO BLADE & BEAM SOCKET & HEADER

28
Gbps

(0.40 mm) .0158" PITCH • SS4/ST4 SERIES



SS4
Mates:
ST4

ST4
Mates:
SS4

SPECIFICATIONS

Insulator Material:
Black LCP
Contact Material:
Phosphor Bronze
Plating:
Au or Sn over
50 μ" (1.27 μm) Ni
Operating Temp Range:
-55 °C to +125 °C
Current Rating:
1.6 A per pin
(2 pins powered)

PROCESSING

Lead-Free Solderable:
Yes
SMT Lead Coplanarity:
(0.10 mm) .004" max

SS4	POSITIONS PER ROW	LEAD STYLE	PLATING OPTION	D	K	"X"R
-----	-------------------	------------	----------------	---	---	------

-10, -20,
-30, -40, -50

-3.00
= 3.00 mm

-L
= 10 μ"
(0.25 μm)
Gold on contact,
Matte Tin on tail

(Required in callout)

-K
= (3.50 mm)
.138" DIA
Polyimide
Film
Pick &
Place Pad

(Required in callout)

-TR
= Tape & Reel

-FR
= Full Reel
Tape & Reel
(must order max.
quantity per reel;
contact Samtec for
quantity breaks)

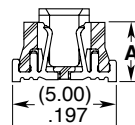
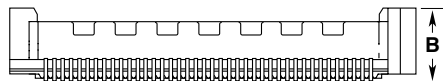
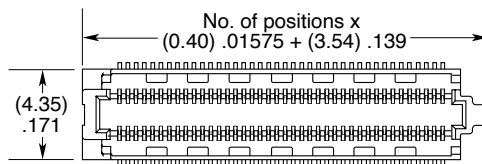

LEAD STYLE	A	B
-3.00	(2.85) .112	(3.50) .138
-3.50	(3.35) .132	(4.00) .157

ST4	POSITIONS PER ROW	LEAD STYLE	PLATING OPTION	D	P	"X"R
-----	-------------------	------------	----------------	---	---	------

-10, -20,
-30, -40, -50

-1.00
= 1.00 mm

-L
= 10 μ"
(0.25 μm)
Gold on contact,
Matte Tin on tail

(Required in callout)

-P
= Pick &
Place Pad

(Required in callout)

-TR
= Tape & Reel

-FR
= Full Reel
Tape & Reel
(must order max.
quantity per reel;
contact Samtec for
quantity breaks)

MATED HEIGHT *

ST4 LEAD STYLE	SS4 LEAD STYLE	
	-3.00	-3.50
-1.00	(4.00 mm) .157"	(4.50 mm) .177"
-1.50	(4.50 mm) .177"	(5.00 mm) .197"
-2.50	(5.50 mm) .217"	(6.00 mm) .236"

*Processing conditions will affect mated height.

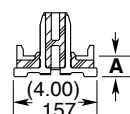
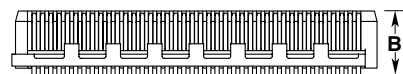
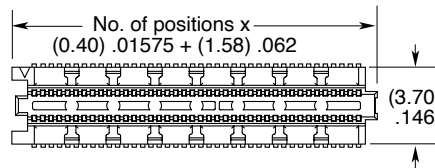

LEAD STYLE	A	B
-1.00	(1.00) .039	(3.08) .121
-1.50	(1.50) .059	(3.58) .141
-2.50	(2.50) .098	(4.58) .180

Note:
Some lengths, styles and options are non-standard, non-returnable.

MICRO BLADE & BEAM SOCKET & HEADER

(0.50 mm) .0197" PITCH • SS5/ST5 SERIES

PAM 4

56
G b p s



SS5
Mates:
ST5

ST5
Mates:
SS5

SPECIFICATIONS

Insulator Material:
Black LCP
Contact Material:
Phosphor Bronze
Plating:
Au or Sn over
50 μ" (1.27 μm) Ni
Operating Temp Range:
-55 °C to +125 °C
Current Rating:
1.5 A per pin
(2 pins powered)

PROCESSING

Lead-Free Solderable:
Yes
SMT Lead Coplanarity:
(0.10 mm) .004" max

SS5	NO. OF POSITIONS	LEAD STYLE	PLATING OPTION	D	K	"X"R
-----	------------------	------------	----------------	---	---	------

-10, -15, -20,
-30, -40, -50,
-60, -70, -80
(Per Row)

-3.00
= 3.00 mm
-3.50
= 3.50 mm

-L
= 10 μ"
(0.25 μm)
Gold on contact,
Matte Tin on tail

(Required in callout)

-K
= (3.50 mm)
.138" DIA
Polyimide
Film
Pick &
Place Pad

(Required in callout)

-TR
= Tape & Reel

-FR
= Full Reel
Tape & Reel
(must order max.
quantity per reel;
contact Samtec for
quantity breaks)

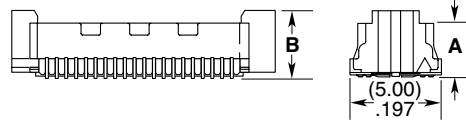
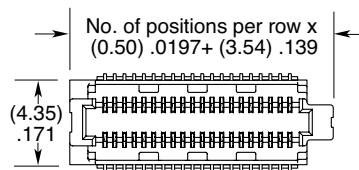

LEAD STYLE	A	B
-3.00	(2.85) .112	(3.50) .138
-3.50	(3.35) .132	(4.00) .157

MATED HEIGHT *

ST5 LEAD STYLE	SS5 LEAD STYLE	
-1.00	(4.00 mm) .157"	(4.50 mm) .177"
-1.50	(4.50 mm) .177"	(5.00 mm) .197"

*Processing conditions will affect mated height.

ST5	NO. OF POSITIONS	LEAD STYLE	PLATING OPTION	D	P	"X"R
-----	------------------	------------	----------------	---	---	------

-10, -15, -20,
-30, -40, -50,
-60, -70, -80
(Per Row)

-1.00
= 1.00 mm
-1.50
= 1.50 mm

-L
= 10 μ"
(0.25 μm)
Gold on contact,
Matte Tin on tail

(Required in callout)

-P
= Pick &
Place Pad

(Required in callout)

-TR
= Tape & Reel

-FR
= Full Reel
Tape & Reel
(must order max.
quantity per reel;
contact Samtec for
quantity breaks)

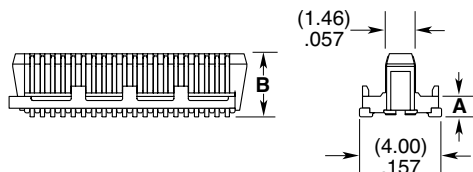
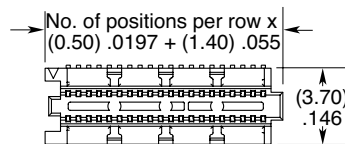

LEAD STYLE	A	B
-1.00	(1.00) .039	(3.08) .121
-1.50	(1.50) .059	(3.58) .141

ALSO AVAILABLE

MOQ Required

Other lead styles

Note:
Some lengths, styles and options are non-standard, non-returnable.

ULTRA-LOW PROFILE HEADER & SOCKET

(0.50 mm) .0197" PITCH • SLH/TLH SERIES

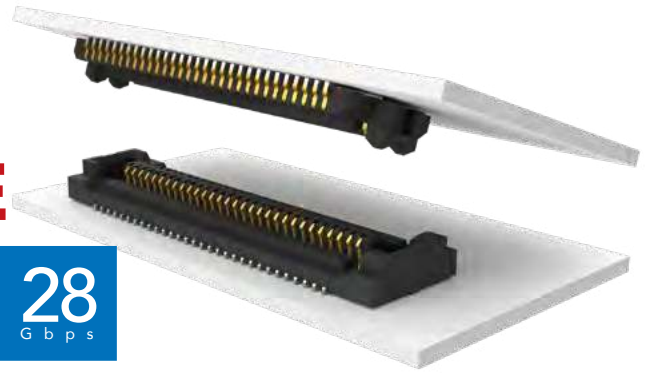

SLH
Mates:
TLH

TLH
Mates:
SLH

SPECIFICATIONS

Insulator Material:
Black Liquid Crystal Polymer
Contact Material:
Copper Alloy
Plating:
Au over 50 μ" (1.27 μm) Ni
Current Rating:
2.1 A per pin
(2 pins powered)
Operating Temp Range:
-55 °C to +125 °C

PROCESSING

Lead-Free Solderable:
Yes
SMT Lead Coplanarity:
(0.10 mm) .004" max
Board Stacking:
For applications requiring two
or more connectors per board,
contact ipg@samtec.com

SLH	NO. OF POSITIONS	LEAD STYLE	PLATING OPTION	D	OPTION	OPTION	"X"R
-----	------------------	------------	----------------	---	--------	--------	------

-010,
-020,
-030
(Per Row)

-1.50
=1.50 mm

-G
= 10 μ"
(0.25 μm)
Gold in
contact,
Gold flash
on tail

-A
= Alignment
Pin

-K
= (3.00 mm)
.118" DIA
Polyimide
Film
Pick &
Place Pad

(Leave blank
for tape &
reel)

-FR
= Full Reel
Tape & Reel
(must order
max. quantity
per reel;
contact
Samtec for
quantity
breaks)

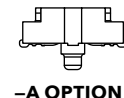
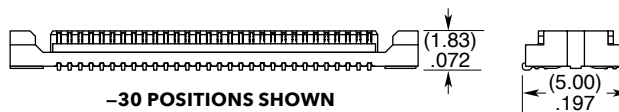
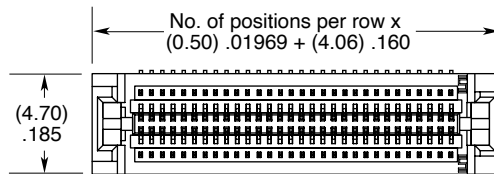

-A OPTION

MATED HEIGHT*

SLH LEAD STYLE	TLH LEAD STYLE
-1.50	-0.50 (2.00) .0787

*Processing conditions will affect mated height.

TLH	NO. OF POSITIONS	LEAD STYLE	PLATING OPTION	D	OPTION	OPTION	"X"R
-----	------------------	------------	----------------	---	--------	--------	------

-010,
-020,
-030
(Per Row)

-0.50
=0.50 mm

-G
= 10 μ"
(0.25 μm)
Gold in
contact,
Gold flash
on tail

-A
= Alignment
Pin

-K
= (3.00 mm)
.118" DIA
Polyimide
Film
Pick &
Place Pad

(Leave blank
for tape &
reel)

-FR
= Full Reel
Tape & Reel
(must order
max. quantity
per reel;
contact
Samtec for
quantity
breaks)

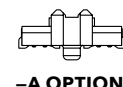
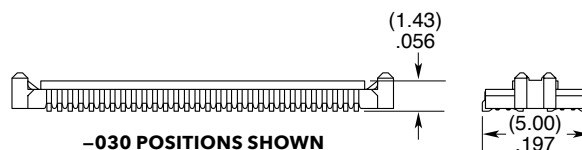
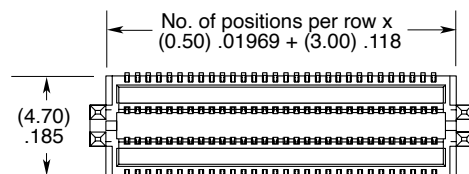

-A OPTION

Note:
Some lengths, styles and
options are non-standard,
non-returnable.

PRECISION BOARD STACKING STANDOFF



SO SERIES

SO

Use With:

QXH, QXE, QXS,
QXSS, QRX8, ERX5,
ERX6, ERX8, LSHM,
LSS, LSEM, SX4, SX5, XLH

SPECIFICATIONS

Material:

Aluminum

Locking Compound:

Nylon



Specify
BOARD STACKER
from chart

-01
= Female Thread/Press-In
(-0515 thru -0865 only)

-02
= Male/Male Thread
(-0515 and
-1115 thru -2515 only)

-03
= Male/Female Thread
(-0815 thru -2515 only)

-05
= Female/Female Thread
(-1524 thru -2515 only)

-01
= #4-40
Thread

-02
= M3 x 0.5
Thread

-L
= -02 & -03
Lead Style
thread locking
compound
(Leave blank for
-01 Lead Style)

INDUSTRY STANDARD SOLUTIONS

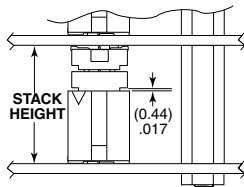

Requires Standoff
SO-1524-03-01-01-L or
JSOM-1524-02 for 15.24 mm
or SO-2200-03-01-01-L
for 22 mm board spacing.
Connectors designed to not
fully seat when mated.
For more information on the JSOM,
visit samtec.com?JSOM

BOARD STACKER	A	BOARD STACK HEIGHT
-0515	(5.15) .203	5 mm
-0715	(7.15) .282	7 mm
-0815	(8.15) .321	8 mm
-0865	(8.65) .341	8.5 mm
-1115	(11.15) .439	11 mm
-1215	(12.15) .478	12 mm
-1524	(15.24) .600	15.09 mm
-1615	(16.15) .636	16 mm
-1890	(18.90) .744	18.75 mm
-1915	(19.15) .754	19 mm
-2515	(25.15) .990	25 mm

INDUSTRY STANDARD	INTERCONNECTS			
	TERMINAL	SOCKET	BANKS	STACK HEIGHT
SUMIT™	ASP-129637-01	ASP-129646-01	1	15.24 mm
PCI/104-Express™	ASP-129637-03	ASP-129646-03	3	15.24 mm
PCI/104-Express™	ASP-129637-13	ASP-129646-22	1	15.24 mm
PCI/104-Express™	ASP-142781-01	ASP-129646-01	1	22 mm
PCI/104-Express™	ASP-142781-02	ASP-129646-02	2	22 mm
PCI/104-Express™	ASP-142781-03	ASP-129646-03	3	22 mm

ALSO AVAILABLE

MOQ Required

Other heights
Stainless Steel
Locking compound removed
Other materials and threading
No Hardware

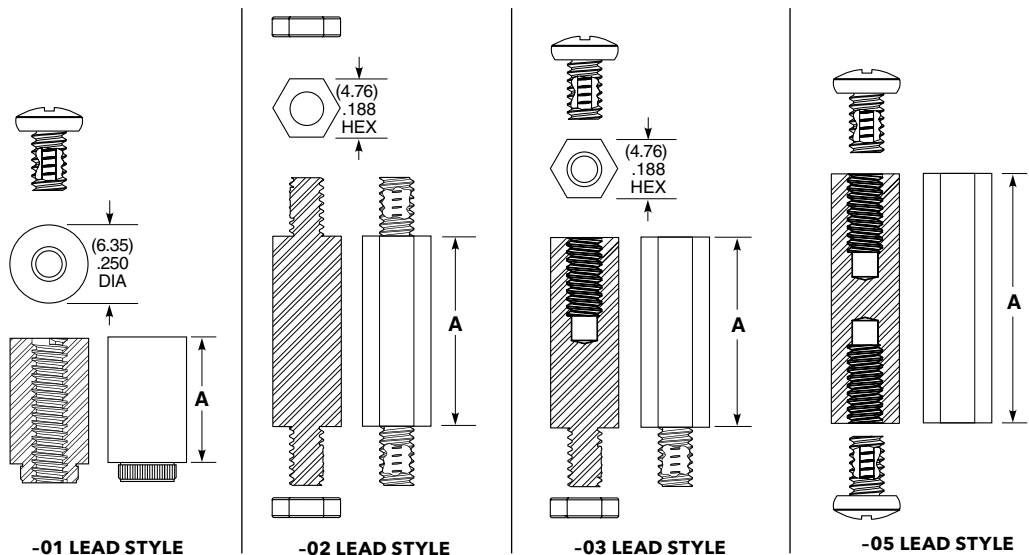

Note:

Some sizes, styles and options are non-standard, non-returnable.

Components are to be packaged in separate bags unassembled.

HIGH-SPEED EDGE CARD SYSTEMS

SPEEDS TO 56 Gbps • RUGGED EDGE RATE® CONTACTS • VARIETY OF OPTIONS

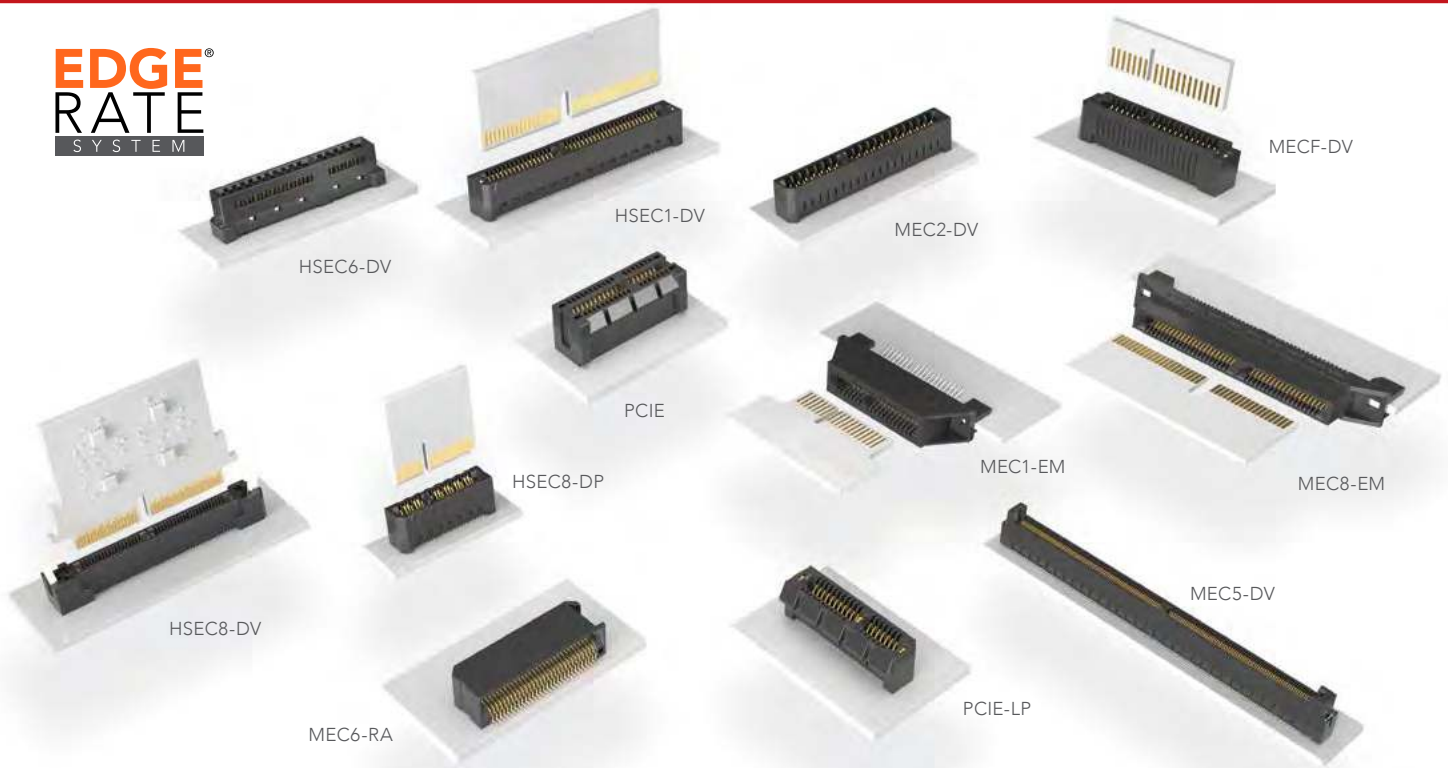

62-69	HIGH-SPEED EDGE CARD INTERCONNECTS	
	0.60 mm Pitch Edge Rate® Socket (HSEC6)	63
	0.80 mm Pitch Rugged Edge Card Socket (HSEC8)	64
	0.80 mm Pitch Edge Rate® Socket (HSEC8)	65-68
	1.00 mm Pitch Edge Rate® Socket (HSEC1)	69
70-77	MICRO/MINI EDGE CARD INTERCONNECTS	
	0.50 mm Pitch Micro Socket (MEC5)	71
	0.635 mm Pitch Micro Socket (MEC6)	72
	0.80 mm Pitch Micro Edge Socket (MEC8)	73-74
	1.00 mm Pitch Mini Edge Card Socket (MEC1)	75-76
	1.27 mm Pitch Mini Edge Card Socket (MECF)	77
	2.00 mm Pitch Mini Edge Card Socket (MEC2)	77
78-80	PCI EXPRESS® INTERCONNECTS	
	PCI Express® & Low Profile PCI Express® Sockets (PCIE)	79
	PCI Express® 4.0 & 5.0 Sockets (PCIE-G4 & PCIE-G5)	80

GENERATE™

HIGH-SPEED EDGE CARD SYSTEMS

0.60 mm, 0.80 mm and 1.00 mm PITCH

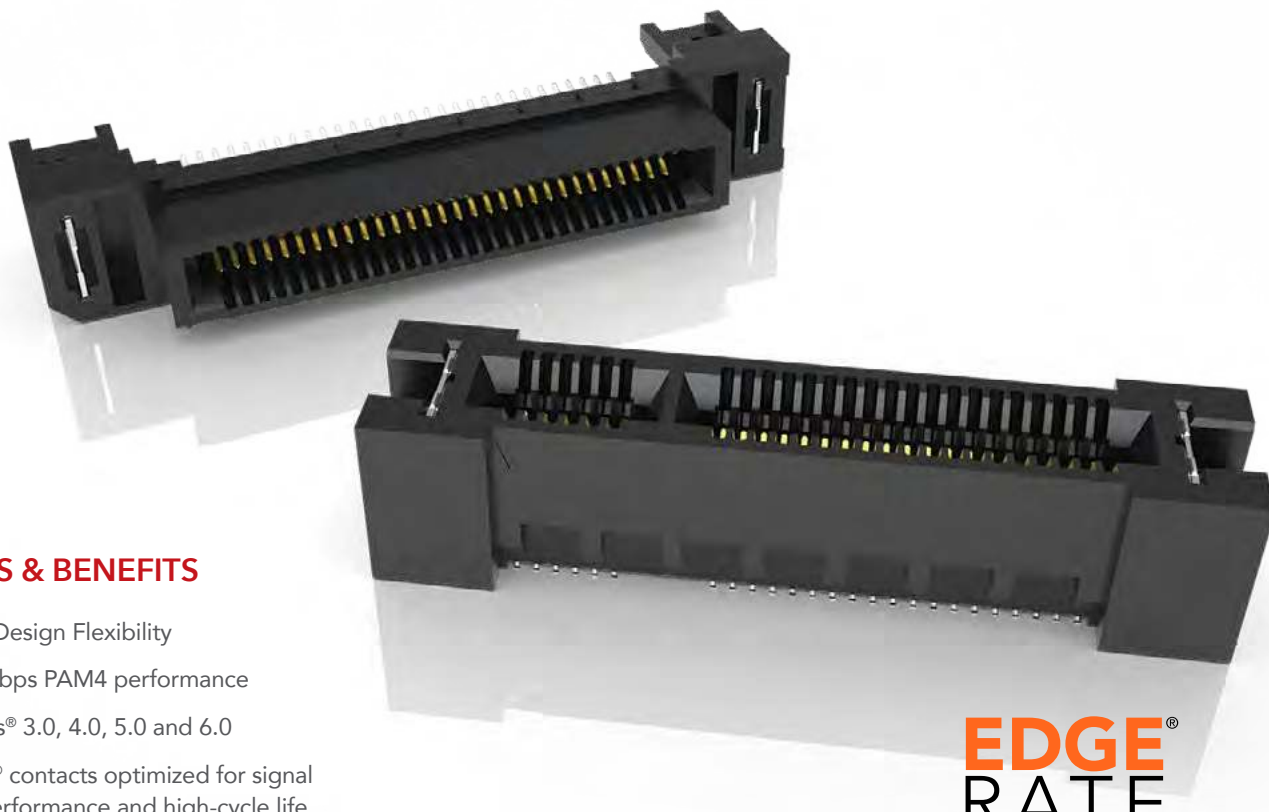

FEATURES & BENEFITS

- Maximum Design Flexibility
- Up to 64 Gbps PAM4 performance
- PCI Express® 3.0, 4.0, 5.0 and 6.0
- Edge Rate® contacts optimized for signal integrity performance and high-cycle life
- Up to 200 positions available
- Vertical, right-angle, edge mount, pass-through orientations
- Power/signal combo, press-fit tails, rugged weld tabs, locks and latches
- Mating cable assemblies available

**EDGE
RATE**
CONTACT

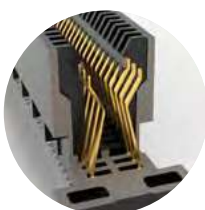

Rugged tucked beam technology (HTEC8)



Differential pair for increased speed (HSEC8-DP)



Custom designs allow for misalignment in the X-Y axes (HSEC1)

KEY SPECIFICATIONS

SERIES	PITCH	TOTAL POSITIONS	INSULATOR MATERIAL	CONTACT MATERIAL	OPERATING TEMP RANGE	CURRENT RATING	VOLTAGE RATING	LEAD-FREE SOLDERABLE
HSEC6	0.60 mm	56-168	Black LCP	Copper Alloy	-55 °C to +125 °C	1.9 A (2 pins)	240 VAC	Yes
HTEC8	0.80 mm	20-200	Black LCP	Copper Alloy	-55 °C to +125 °C	3.0 A (2 pins)	215 VAC	Yes
HSEC8	0.80 mm	18-200	Black LCP	BeCu	-55 °C to +125 °C	2.8 A (2 pins)	240 VAC	Yes
HSEC1	1.00 mm	20-140	Black LCP	Phosphor Bronze	-55 °C to +125 °C	2.2 A (2 pins)	215 VAC	Yes

(0.60 mm) .024" PITCH • VERTICAL EDGE CARD SOCKET

HSEC6	POSITIONS PER ROW	CARD THICKNESS	PLATING OPTION	DV	SHIELD OPTION	WT	"X"R
	-028, -042, -070, -084	-01 = (1.60 mm) .062" thick card	-S = 30 μ" (0.76 μm) Gold on contact area, Matte Tin on tail		Leave blank for no shield -S = Shield (not available with -084 positions)	Required for everything but shielded -028 positions -WT = Weld tab	-TR = Tape & Reel -FR = Full Reel Tape & Reel (must order max. quantity per reel; contact Samtec for quantity breaks)

HSEC6
Card Mates:
(1.60 mm)
.062" card



Cable Mates:
GC6

ALSO AVAILABLE

0.60 mm Pitch Mating High-Speed Cable Assembly. See GC6 Series.

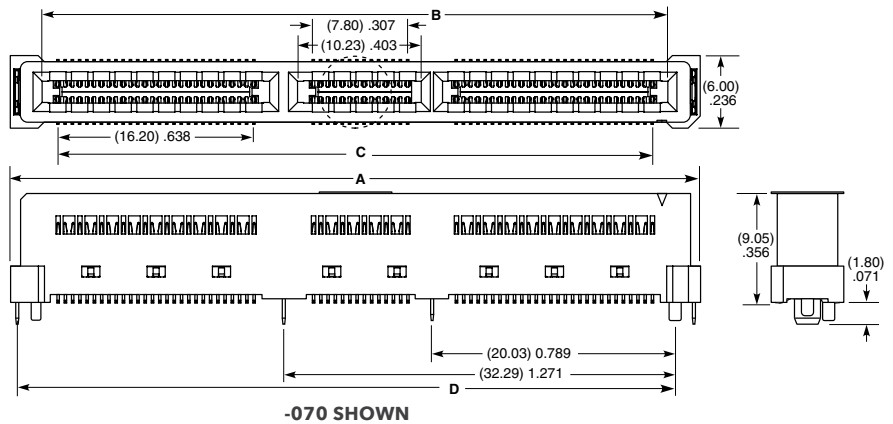

STANDARDS

SFF-TA-1002
Visit www.samtec.com/standards for more information.

HIGH-SPEED PAIRS	SFF-TA-1002	POSITIONS PER ROW	A	B	C	D
x4, 8 DP's	1C	-028	(23.88) .940	(18.62) .733	(16.20) .638	(21.18) .834
x8, 16 DP's	2C	-042	(35.60) 1.402	(30.61) 1.205	(28.01) 1.103	(32.90) 1.295
	4C	-070	(57.02) 2.245	(51.72) 2.036	(49.12) 1.934	(54.32) 2.139
x16, 32 DP's	4C+	-084	(69.17) 2.723	(63.92) 2.516	(61.32) 2.414	(66.52) 2.619

Note:
Polyimide film pick & place pad is standard.

Some sizes, styles and options are non-standard, non-returnable

View complete specifications at: samtec.com?HSEC6-DV

(0.80 mm) .0315" PITCH • RUGGED HIGH-SPEED EDGE CARD SOCKET

HTEC8 - **1** POSITIONS PER ROW - **01** - **PLATING OPTION** - **DV** - **OPTION** - **OTHER OPTION** - **"X"R**

**10, 20,
30, 40, 50,
60, 80, 100**

-L
= 10 μ"
(0.25 μm)
Gold on
contact area,
Matte Tin
on tail

-S
= 30 μ"
(0.76 μm)
Gold on
contact area,
Matte Tin
on tail

Leave blank for no
alignment pin

-A
= Alignment Pin

-WT
= Weld Tab
(-A option required)

-K
= (7.00 mm)
.276" DIA
Polyimide
Pick &
Place Pad

Leave blank for
Tray Packaging

-TR
= Tape & Reel
(10 thru 60
positions only)

-FR
= Full Reel
Tape & Reel
(must order max.
quantity per reel;
contact Samtec
for quantity breaks)
(10 thru 60
positions only)

HTEC8

Card Mates:
(1.60 mm) .062"
thick card

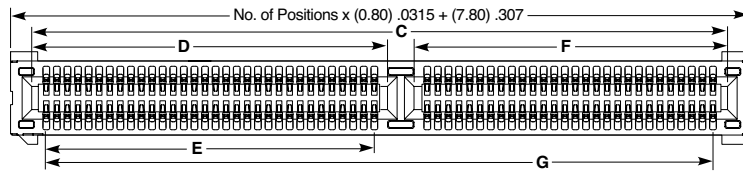

40, 50, 60, 80 & 100 POSITIONS

POSITIONS PER ROW	C	D	E	F	G
40	(36.60) 1.440	(18.90) .744	(16.80) .661	(15.70) .618	(34.40) 1.354
50	(44.60) 1.756	(22.90) .902	(20.80) .819	(19.70) .776	(42.40) 1.669
60	(52.60) 2.071	(26.90) 1.059	(24.80) .976	(23.70) .933	(50.40) 1.984
80	(68.60) 2.701	(26.90) 1.059	(24.80) .976	(39.70) 1.563	(66.40) 2.614
100	(84.60) 3.331	(26.90) 1.059	(24.80) .976	(55.70) 2.193	(82.40) 3.244

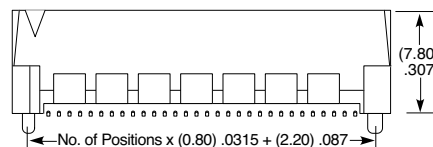
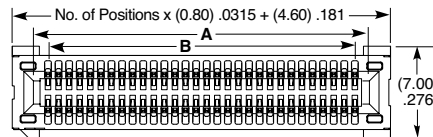

10, 20 & 30 POSITIONS

POSITIONS PER ROW	A	B
10	(9.40) .370	(7.20) .283
20	(17.40) .685	(15.20) 5.98
30	(25.40) 1.000	(23.20) .913

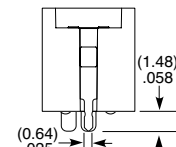
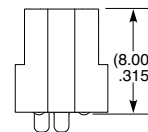

**-WT
OPTION**

Note:
Some sizes, styles and
options are non-standard,
non-returnable.

View complete specifications at: samtec.com?HTEC8

(0.80 mm) .0315" PITCH • VERTICAL EDGE CARD SOCKET

HSEC8	1	POSITIONS PER ROW	CARD THICKNESS	PLATING OPTION	DV	A	OTHER OPTIONS	"X"R
		09, 10, 13, 20, 25, 30, 37, 40, 49, 50, 60, 70, 80, 100 (13, 25, 49 only available with -L or -L2 latching option; 09 only available with -L2 option; 37 only available with -L latching option)	-01 = (1.60 mm) .062" thick card -03 = (2.36 mm) .093" thick card	-L = 10 μm (0.25 μm) Gold on contact area, Matte Tin on tail -S = 30 μm (0.76 μm) Gold on contact area, Matte Tin on tail			-K = Polyimide Pick & Place Pad -BL = Board Locks; -01 card only (Weld tab standard) -L = Latching Option; -01 card only (13, 25, 37, 49 only) (Weld tab standard) -L2 = ECDP Latching; -01 card only (09, 13, 25, 49 only) (For use with ECDP) (Weld tab standard) -WT = Weld tab	Leave blank for Tray Packaging -TR = Tape & Reel (09 - 70 only) -FR = Full Reel Tape & Reel (must order max. quantities per reel; contact Samtec for quantity breaks) (09-70 only)

HSEC8-DV

Card Mates:
 (1.60 mm) .062" card,
 (2.36 mm) .093" card,
 HSC8

Cable Mates:
 ECDP

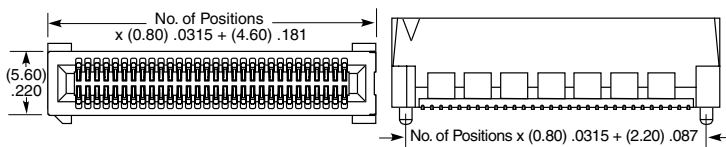

10, 20, & 30 POSITIONS

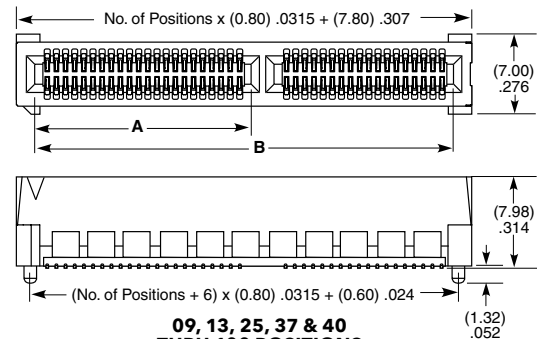

09, 13, 25, 37 & 40 THRU 100 POSITIONS

OTHER SOLUTIONS

For complete edge card system with cards and sockets, visit samtec.com?RU8

For a card to mate with an HSEC8 socket, visit samtec.com?HSC8



POSITIONS PER ROW	A	B	CABLE	CONNECTOR
09*†	(4.50) .177	(11.80) .465	ECDP-04	HSEC8-109-L2
13*†	(6.10) .240	(15.00) .591	ECDP-08	HSEC8-113-L2
25*†	(6.10) .240	(24.60) .969	ECDP-16	HSEC8-125-L2
37†	(18.10) .713	(34.20) 1.346	ECDP-32	HSEC8-149-L2
40	(18.90) .744	(36.60) 1.441		
49*†	(22.90) .902	(43.80) 1.724		
50	(22.90) .902	(44.60) 1.756		
60	(26.90) 1.059	(52.60) 2.071		
70†	(26.90) 1.059	(60.60) 2.386		
80†	(26.90) 1.059	(68.60) 2.701		
100†	(26.90) 1.059	(84.60) 3.331		

Positions where no dimensions are given do not have keying feature.

* Mates with ECDP Series

† Available with -01 Card Only

Note:
 Some sizes, styles and options are non-standard, non-returnable.

View complete specifications at: samtec.com?HSEC8-DV

(0.80 mm) .0315" PITCH • RIGHT-ANGLE & EDGE MOUNT SOCKET

HSEC8	- 1	POSITIONS PER ROW	CARD THICKNESS	PLATING OPTION	RA	OTHER OPTIONS	"X"R
--------------	------------	--------------------------	-----------------------	-----------------------	-----------	----------------------	-------------

09, 10, 13,
20, 25, 30,
40, 49, 50, 60

-01
= (1.60 mm) .062"
thick card

-L
= 10 μ" (0.25 μm)
Gold on contact area,
Matte Tin on tail

-S
= 30 μ" (0.76 μm)
Gold on contact area,
Matte Tin on tail

-BL
= Board Locks
(09, 13, 25, 40,
49, 50, 60 only)

-L2
= ECDP Latching
(09, 13, 25, 49 only)

Leave blank for
Tray Packaging

-TR
= Tape & Reel

-FR
= Full Reel
Tape & Reel Packaging
(must order max.
quantity per reel;
contact Samtec for
quantity breaks)

HSEC8-RA

Card Mates:
(1.60 mm) .062"
thick card,
HSC8
Cable Mates:
ECDP



POSITIONS PER ROW	A	B	C
40	(43.80) 1.724	(18.90) .744	(36.60) 1.441
50	(51.80) 2.039	(22.90) .902	(44.60) 1.756
60	(59.80) 2.354	(26.90) 1.059	(52.60) 2.071
40-BL	(51.30) 2.020	(18.90) .744	(36.60) 1.441
50-BL	(59.30) 2.335	(22.90) .902	(44.60) 1.756
60-BL	(67.30) 2.650	(26.90) 1.059	(52.60) 2.071

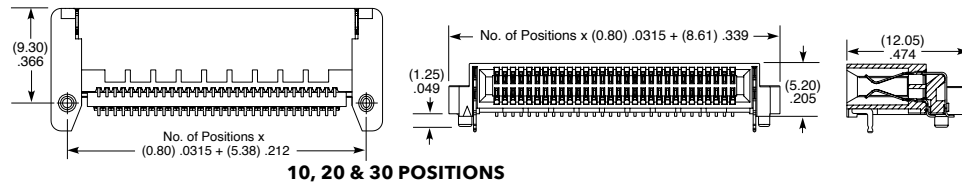
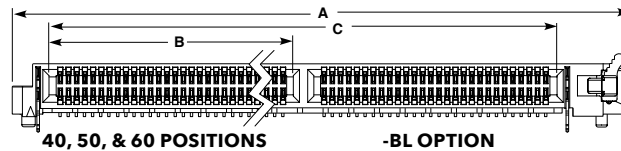

View complete specifications at: samtec.com?HSEC8-RA

HSEC8	- 1	POSITIONS PER ROW	- 01	PLATING OPTION	- D	EM2
--------------	------------	--------------------------	-------------	-----------------------	------------	------------

10, 20, 30, 40, 50, 60

-L
= 10 μ" (0.25 μm)
Gold on contact area,
Matte Tin on tail

-S
= 30 μ" (0.76 μm)
Gold on contact area,
Matte Tin on tail

-EM2
= (1.60 mm) .062"
thick PCB

HSEC8-EM

Card Mates:
(1.60 mm) .062"
thick card,
HSC8
Cable Mates:
ECDP

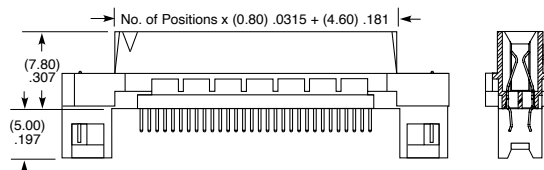
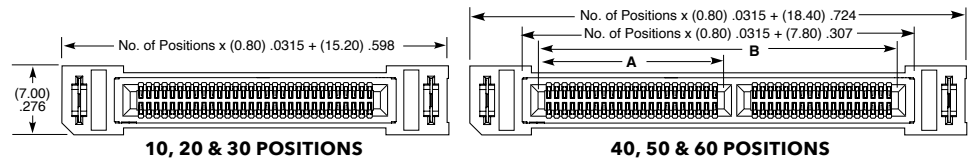

POSITIONS PER ROW	A	B
40	(18.90) .744	(36.60) 1.441
50	(22.90) .902	(44.60) 1.756
60	(26.90) 1.059	(52.60) 2.071

View complete specifications at: samtec.com?HSEC8-EM

Note:
Some sizes, styles and
options are non-standard,
non-returnable.

(0.80 mm) .0315" PITCH • PASS-THROUGH & POWER COMBO

HSEC8	1	POSITIONS PER ROW	CARD THICKNESS	PLATING OPTION	DV	A	PE	OTHER OPTIONS	"X"R
--------------	----------	--------------------------	-----------------------	-----------------------	-----------	----------	-----------	----------------------	-------------

10, 13, 20

-01
= (1.60 mm) .062" thick card

-L
= 10 μ" (0.25 μm)
Gold on contact area, Matte Tin on tail

-S
= 30 μ" (0.76 μm)
Gold on contact area, Matte Tin on tail

-K
= (5.50 mm) .217" DIA
Polyimide Film Pick & Place Pad

Leave blank for Tray Packaging

-TR
=Tape & Reel Packaging

-FR
= Full Reel Tape & Reel Packaging
(Must order max. quantities per reel. Contact Samtec for parts per reel)

HSEC8-PE

Card Mates:
(1.60 mm) .062" thick card, HSC8

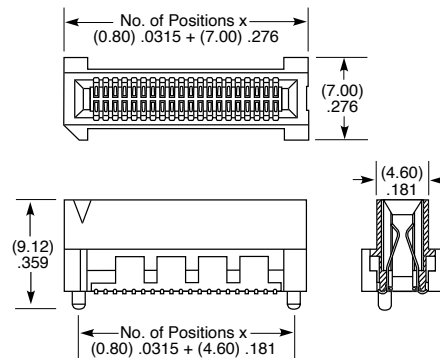

ALSO AVAILABLE

1.00 mm High-Speed Micro Plane Socket.
View complete specifications at samtec.com?SAL1

View complete specifications at: samtec.com?HSEC8-DV

HSEC8	1	SIGNAL POSITIONS	CARD THICKNESS	PLATING OPTION	PV	POWER POSITIONS	POWER TAIL	OTHER OPTION
--------------	----------	-------------------------	-----------------------	-----------------------	-----------	------------------------	-------------------	---------------------

20, 30, 40
(Signal positions per row)

-01
= (1.60 mm) .062" thick card

-L
= 10 μ" (0.25 μm)
Gold on contact area, Matte Tin on tail

-S
= 30 μ" (0.76 μm)
Gold on contact area, Matte Tin on tail

-2, -4
(Total, 2 per power bank)

-1
= Use with (1.60 mm) .062" Thick PCB

-2
= Use with (2.36 mm) .093" Thick PCB

-WT
= Weld Tab

HSEC8-PV

Card Mates:
(1.60 mm) .062" thick card

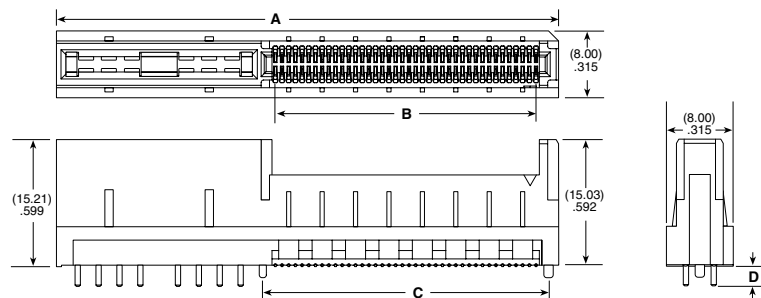

SIGNAL POSITIONS	POWER POSITIONS					
	A (-2)	B (-2)	C (-2)	A (-4)	B (-4)	C (-4)
20	(32.10) 1.264	(15.20) .598	(18.20) .717	(44.10) 1.736	(15.20) .598	(18.20) .717
30	(40.10) 1.579	(23.20) .913	(26.20) 1.031	(52.10) 2.051	(23.20) .913	(26.20) 1.031
40	(48.10) 1.894	(31.20) 1.228	(34.20) 1.346	(60.10) 2.366	(31.20) 1.228	(34.20) 1.346

POWER TAIL	D
-1	(2.35) .093
-2	(3.13) .123

Note:
Some sizes, styles and options are non-standard, non-returnable.

View complete specifications at: samtec.com?HSEC8-PV

0.80 mm (.0315") PITCH • DIFFERENTIAL PAIR EDGE CARD

HSEC8	1	NUMBER OF PAIRS	01	PLATING OPTION	DP	A	OPTION	K	"X"R
		08, 12, 16, 20, 32, 56 (Total Pairs)		-L = 10 μ" (0.25 μm) Gold on contact area, Matte Tin on tail			Leave blank for no weld tab -WT = Weld Tab	-K = (6.25 mm) .246" DIA Polyimide Film Pick & Place Pad	Leave blank for Tape & Reel -FR = Full Reel Tape & Reel (must order max. quantity per reel; contact Samtec for quantity breaks)

HSEC8-DP
Card Mates:
(1.60 mm) .062" thick card

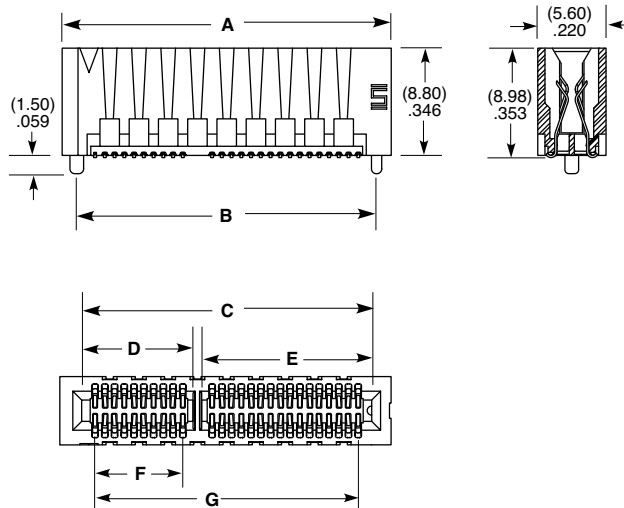

NUMBER OF PAIRS	A	B	C	D	E	F	G
08	(17.40) .685	(15.00) .591	(14.20) .559	(4.34) .171	(9.14) .360	(2.40) .094	(12.00) .472
12	(22.20) .874	(19.80) .780	(19.00) .748	(6.74) .265	(11.54) .454	(4.80) .189	(16.80) .661
16	(27.00) 1.063	(24.60) .969	(23.80) .937	(9.14) .360	(13.94) .549	(7.20) .283	(21.60) .850
20	(31.80) 1.252	(29.40) 1.157	(28.60) 1.126	(11.54) .454	(16.34) .643	(9.60) .378	(26.40) 1.039
32	(46.20) 1.819	(43.80) 1.724	(43.00) 1.693	(18.74) .738	(23.54) .927	(16.80) .661	(40.80) 1.606
56	(75.00) 2.953	(72.60) 2.858	(71.80) 2.827	(33.14) 1.305	(37.94) 1.494	(31.20) 1.228	(69.60) 2.740

Note:
Some sizes, styles and options are non-standard, non-returnable.

View complete specifications at: samtec.com?HSEC8-DP

1.00 mm (.0394") PITCH • VERTICAL HIGH-SPEED EDGE CARD

HSEC1	POSITIONS PER ROW	CARD THICKNESS	PLATING OPTION	DV	OPTION	OTHER OPTION	"X"R
	-010, -020, -030, -040, -050, -060, -070	-01 =(1.60 mm) .062" thick card	-L = 10 μ" (0.25 μm) Gold on contact area, Matte Tin on tail -S = 30 μ" (0.76 μm) Gold on contact area, Matte Tin on tail		-A or -WT required in callout -A =Alignment Pin (Not available with -WT) -WT =Weld tab (Not available with -A)	-K =(7.01 mm) .276" DIA Polyimide Film Pick & Place Pad	-TR or -FR required for 10-60 positions. Leave blank for 70 positions. -TR =Tape & Reel -FR = Full Reel Tape & Reel (must order max. quantity per reel; contact Samtec for quantity breaks)

HSEC1-DV
Card Mates:
(1.60 mm) .062"
thick card

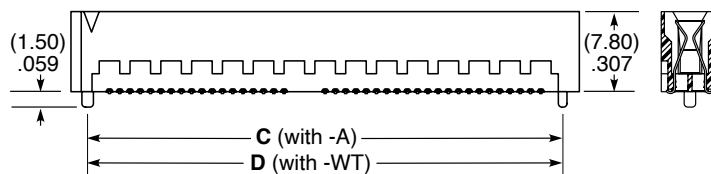
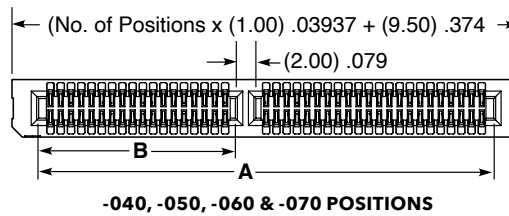
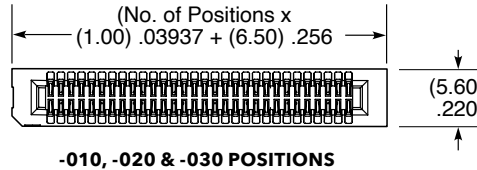
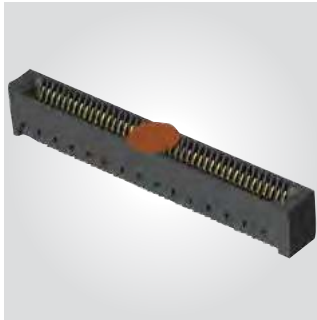

POSITIONS PER ROW	A	B	C (with -A)	D (with -WT)
-010	(11.30) .445	N/A	(13.25) .522	(14.50) .571
-020	(21.30) .839	N/A	(23.25) .915	(24.50) .965
-030	(31.30) 1.232	N/A	(33.25) 1.309	(34.50) 1.358
-040	(44.30) 1.744	(19.15) .754	(46.25) 1.821	(47.50) 1.870
-050	(54.30) 2.138	(24.15) .951	(56.25) 2.215	(57.50) 2.264
-060	(64.30) 2.531	(29.15) 1.148	(66.25) 2.608	(67.50) 2.657
-070	(74.30) 2.925	(34.15) 1.344	(76.25) 3.002	(77.50) 3.051

Note:
Some sizes, styles and
options are non-standard,
non-returnable.

View complete specifications at: samtec.com?HSEC1-DV

MICRO EDGE CARD SYSTEMS

0.50 mm, 0.635 mm, 0.80 mm, 1.00 mm, 1.27 mm, 2.00 mm PITCH

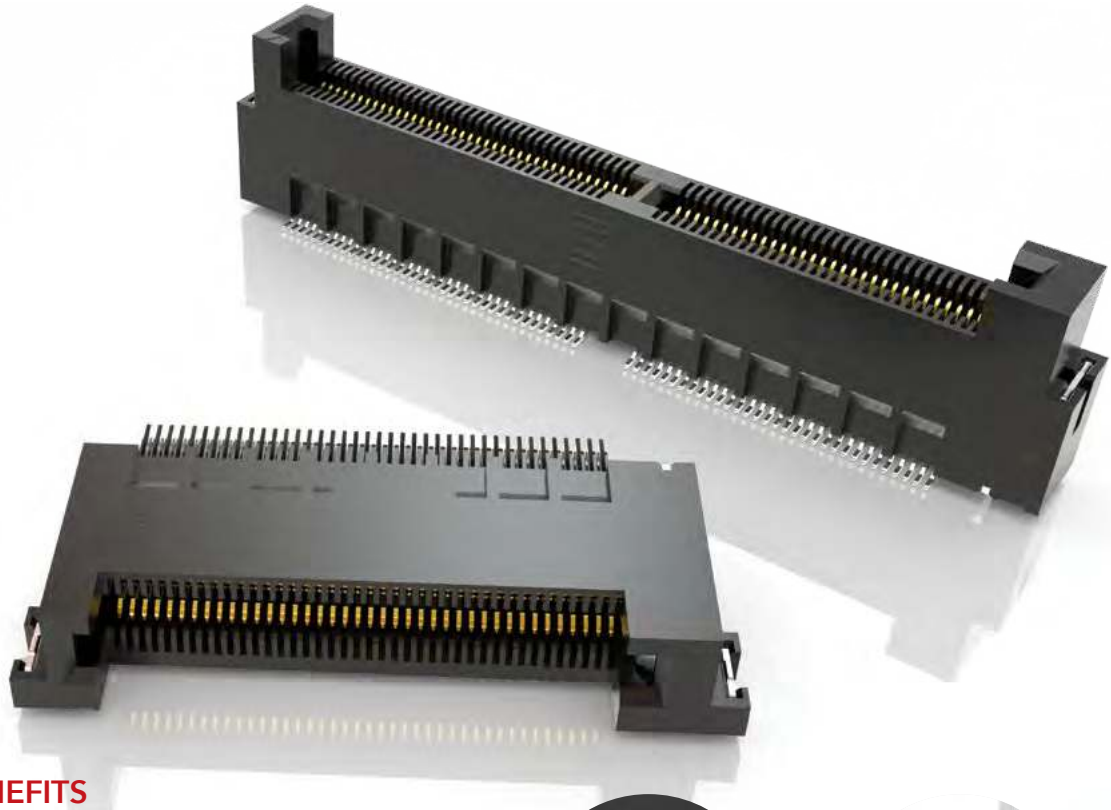

FEATURES & BENEFITS

- Up to 56 Gbps PAM4
- PCI Express® 4.0 (MEC5 Series)
- Solutions for (1.60 mm) .062" and (2.36 mm) .093" thick cards
- Choice of pitch: 0.50 mm, 0.635 mm, 0.80 mm, 1.00 mm, 1.27 mm, 2.00 mm
- Vertical, right-angle and edge mount orientations
- Available in surface mount and through-hole

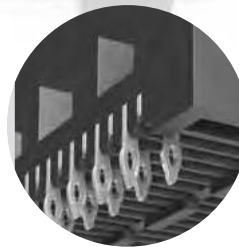

Staggered press-fit tails
(MEC8-VP)

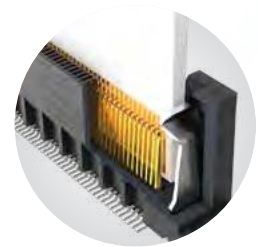

Justification beam ensures
card and body are flush
(MEC5)

KEY SPECIFICATIONS

SERIES	PITCH	TOTAL POSITIONS	INSULATOR MATERIAL	CONTACT MATERIAL	OPERATING TEMP RANGE	CURRENT RATING	VOLTAGE RATING	LEAD-FREE SOLDERABLE
MEC5	0.50 mm	60-200	Black LCP	Phosphor Bronze	-55 °C to +125 °C	1.5 A (2 pins)	125 VAC	Yes
MEC6	0.635 mm	20-140	Black LCP	Phosphor Bronze	-55 °C to +125 °C	2.4 A (2 pins)	185 VAC	Yes
MEC8	0.80 mm	20-140	Black LCP	Phosphor Bronze	-55 °C to +125 °C	2.3 A (2 pins)	180 VAC	Yes
MEC1	1.00 mm	20-140	Black LCP	Phosphor Bronze	-55 °C to +125 °C	2.2 A (2 pins)	250 VAC	Yes
MECF	1.27 mm	10-100	Black/Natural LCP	BeCu	-55 °C to +125 °C	3.5 A (2 pins)	280 VAC	Yes
MEC2	2.00 mm	10-100	Black/Natural LCP	BeCu	-55 °C to +125 °C	3.5 A (2 pins)	235 VAC	Yes

(0.50 mm) .0197" PITCH • MICRO EDGE CARD SOCKET

MEC5	POSITIONS PER ROW	01	PLATING OPTION	TAIL OPTION	WELD TAB OPTION	OTHER OPTION	"X"R
	-030, -040, -050, -060, -070, -080 (-RA & -DV) -090, -100 (-DV only)		-L =10 μ" (0.25 μm) Gold on contact, Matte Tin on tail	-DV Vertical -RA Right-angle	-W1 = Weld Tab Through-hole (Required for -DV option) -W2 = Weld Tab Surface Mount (Not available for -DV)	-K = Polyimide Pick & Place Pad (Required for -DV) (Not available in -RA)	-TR = Tape & Reel -FR = Full Reel Tape & Reel (must order max. quantity per reel; contact Samtec for quantity breaks)

MEC5-DV

Card Mates:
(1.60 mm) .062"
thick card with
standard board
tolerance

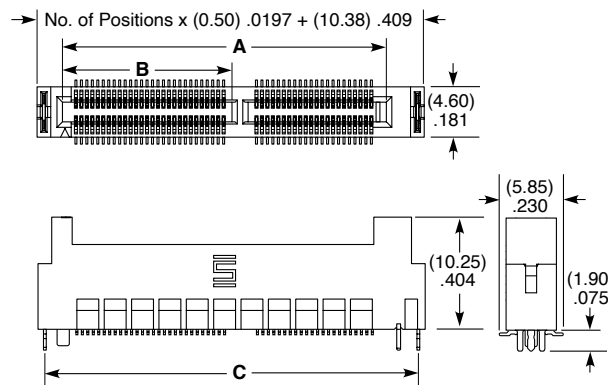
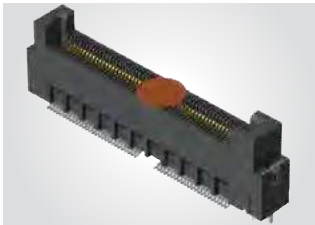

POSITIONS PER ROW	A	B	C
-030	(17.10) .673	N/A	(21.63) .852
-040	(22.10) .870	N/A	(26.63) 1.048
-050	(29.60) 1.165	(15.48) .609	(34.13) 1.344
-060	(34.60) 1.362	(17.98) .708	(39.13) 1.541
-070	(39.60) 1.559	(20.48) .806	(44.13) 1.737
-080	(44.60) 1.756	(22.98) .905	(49.13) 1.934
-090	(49.60) 1.953	(25.48) 1.003	(54.13) 2.131
-100	(54.60) 2.150	(27.98) 1.102	(59.13) 2.328

Note: Polarization rib is not present on -030 & -040 positions

View complete specifications at: samtec.com?MEC5-DV

MEC5-RA

Card Mates:
(1.60 mm) .062"
thick card with
standard board
tolerance

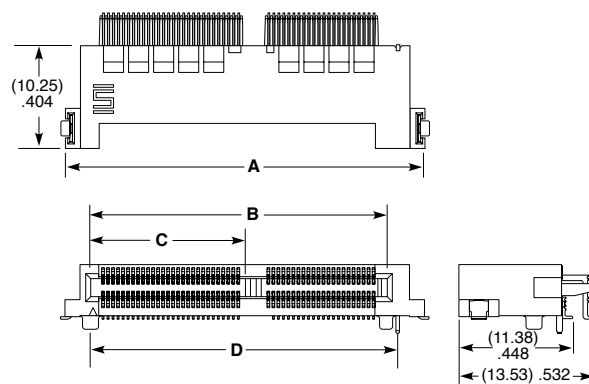
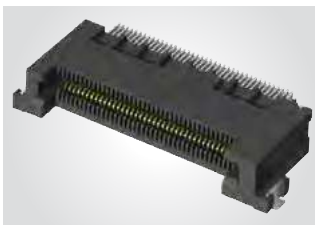

POSITIONS PER ROW	A	B	C	D
-30	(23.38) .920	(17.10) .673	N/A	(18.16) .715
-40	(28.38) 1.117	(22.10) .870	N/A	(23.16) .912
-50	(35.88) 1.413	(29.60) 1.165	(15.44) .608	(30.66) 1.207
-60	(40.88) 1.609	(34.60) 1.362	(17.94) .706	(35.66) 1.404
-70	(45.88) 1.806	(39.60) 1.559	(20.44) .805	(40.66) 1.601
-80	(50.88) 2.003	(44.60) 1.756	(22.94) .903	(45.66) 1.798

Note: Polarization rib is not present on -030 & -040 positions

View complete specifications at: samtec.com?MEC5-RA

Note:
Some sizes, styles and
options are non-standard,
non-returnable.

(0.635 mm) .025" PITCH • VERTICAL AND RIGHT-ANGLE EDGE CARD SOCKET

MEC6 - **1** POSITIONS PER ROW - **02** - PLATING OPTION - **DV** - **A** - OPTION - "X"R

10, 20, 30, 40,
50, 60, 70

-L
= 10 μ" (0.25 μm)
Gold on contact,
Matte Tin on tail

-K
= (5.50 mm) 2.17" DIA
Polyimide Pick
& Place Pad

Leave blank
for Tray Packaging

-TR
= Tape & Reel

-FR
= Full Reel
Tape & Reel
(must order max.
quantity per reel;
contact Samtec for
quantity breaks)

MEC6-DV

Card Mates:
(1.60 mm) .062"
thick card



POSITIONS PER ROW	A	B
50	(21.06) .829	(36.49) 1.437
60	(24.87) .979	(42.84) 1.687
70	(28.68) 1.129	(49.19) 1.937

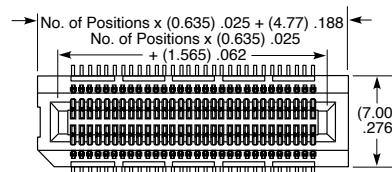

10, 20, 30 & 40 POSITIONS

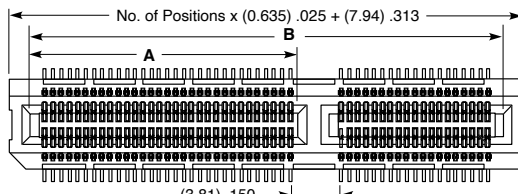

50, 60 & 70 POSITIONS

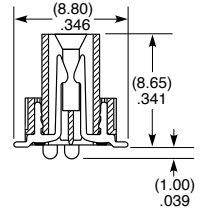
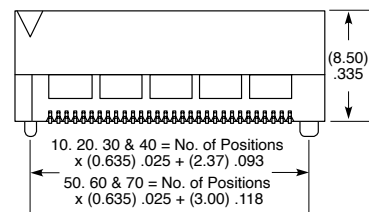

View complete specifications at: samtec.com?MEC6-DV

MEC6 - **1** POSITIONS PER ROW - **02** - PLATING OPTION - **D** - TAIL - OPTIONS

10, 20, 30,
40, 50

-L
= 10 μ" (0.25 μm)
Gold on contact,
Matte Tin on tail

-RA1
= Right-angle

-TR
= Tape & Reel

-FR
= Full Reel Tape & Reel
(must order max. quantity
per reel; contact Samtec
for quantity breaks)

MEC6-RA

Card Mates:
(1.60 mm) .062"
thick card

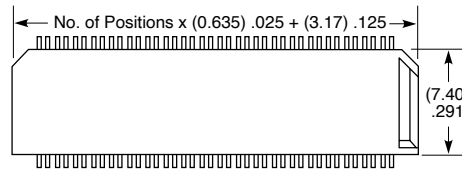

10, 20, 30 & 40 POSITIONS

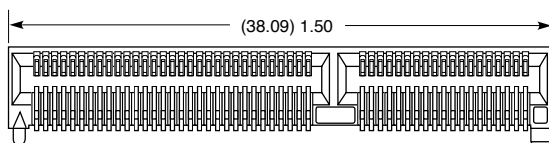

50 POSITIONS

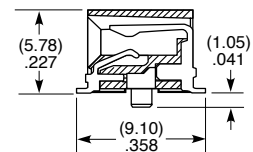

Note:
Some sizes, styles and
options are non-standard,
non-returnable.

View complete specifications at: samtec.com?MEC6-RA

(0.80 mm) .0315" PITCH • VERTICAL AND PRESS-FIT EDGE CARD SOCKET

MEC8 - **1** POSITIONS PER ROW - **02** PLATING OPTION - **DV** OTHER OPTIONS - **"X"R**

10, 20, 30, 40,
50, 60, 70

-L
= 10 μ" (0.25 μm)
Gold on contact,
Matte Tin on tail

-A
= Alignment Pin

-K
= (5.50 mm) 2.17" DIA
Polyimide Pick
& Place Pad

Leave blank for
Tray Packaging

-TR
= Tape & Reel

-FR
= Full Reel
Tape & Reel
(must order max.
quantity per reel;
contact Samtec for
quantity breaks)

MEC8-DV

Card Mates:
(1.60 mm) .062"
thick card



POSITIONS PER ROW	A	B
40	(18.90) .744	(36.60) 1.441
50	(22.90) .902	(44.60) 1.756
60	(26.90) 1.059	(52.60) 2.071
70	(30.90) 1.217	(60.60) 2.386

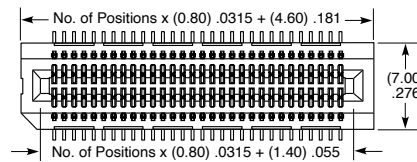

25
Gbps

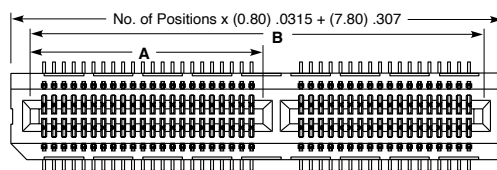

40, 50, 60 & 70 POSITIONS

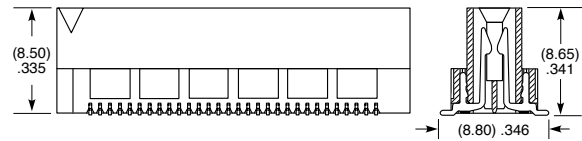

View complete specifications at: samtec.com?MEC8-DV

MEC8 - **1** POSITIONS PER ROW - **CARD THICKNESS** - **PLATING OPTION** - **TAIL**

10, 20, 30, 40

-02
= (1.60 mm) .062"
thick card

-L
= 10 μ" (0.25 μm) Gold on contact,
Matte Tin on tail

-VP
= Press-fit

MEC8-VP

Card Mates:
(1.60 mm) .062"
thick card

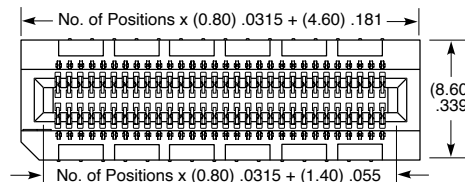
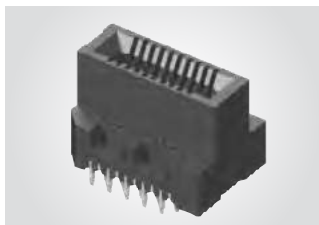

10, 20 & 30 POSITIONS

14
Gbps

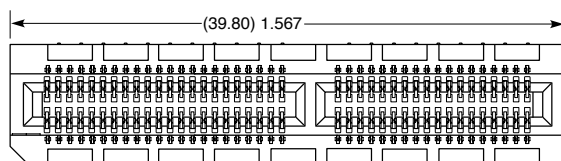

40 POSITIONS

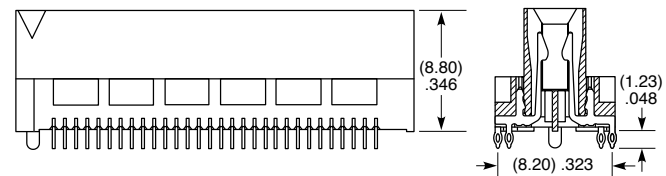

Note:
Some sizes, styles and
options are non-standard,
non-returnable.

View complete specifications at: samtec.com?MEC8-VP

(0.80 mm) .0315" PITCH • RIGHT-ANGLE/EDGE MOUNT EDGE CARD SOCKET

MEC8 - 1 POSITIONS PER ROW - 02 - PLATING OPTION - D - RA1 - "X"R

10, 13, 20,
25, 30, 37, 40,
49, 50

-L
= 10 μm (0.25 μm)
Gold on contact,
Matte Tin on tail

Leave blank
for Tray Packaging

-TR
= Tape & Reel

-FR
= Full Reel
Tape & Reel
(must order max.
quantity per reel;
contact Samtec for
quantity breaks)

MEC8-RA

Card Mates:
(1.60 mm) .062"
thick card

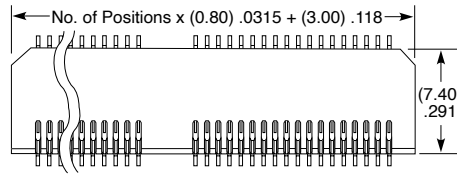
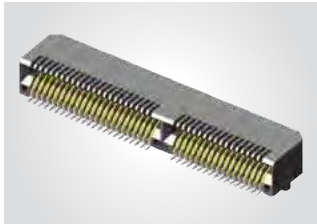

POSITIONS PER ROW	A	B
13	(6.10) .240	(15.00) .591
25		(24.60) .969
37	(18.10) .713	(34.20) 1.346
40	(18.90) .744	(36.60) 1.441
49		(43.80) 1.724
50	(22.90) .902	(44.60) 1.756

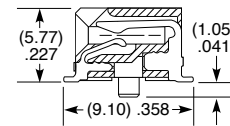
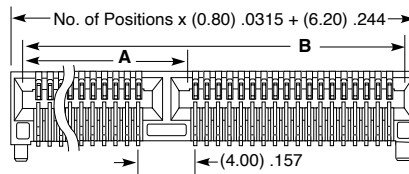

View complete specifications at: samtec.com?MEC8-RA

MEC8 - 1 POSITIONS PER ROW - 02 - PLATING OPTION - D - EM2

10, 20, 30, 40, 50, 60, 70

-L
= 10 μm (0.25 μm) Gold on contact,
Matte Tin on tail

MEC8-EM

Card Mates:
(1.60 mm) .062"
thick card

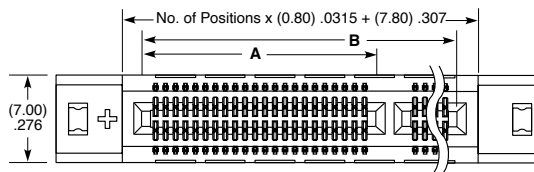
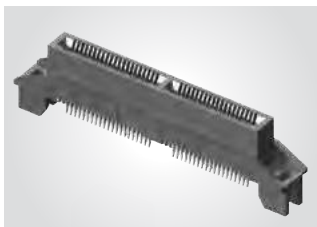

POSITIONS PER ROW	A	B
40	(18.90) .744	(36.60) 1.441
50	(22.90) .902	(44.60) 1.756
60	(26.90) 1.059	(52.60) 2.071
70	(30.90) 1.217	(60.60) 2.386

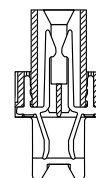
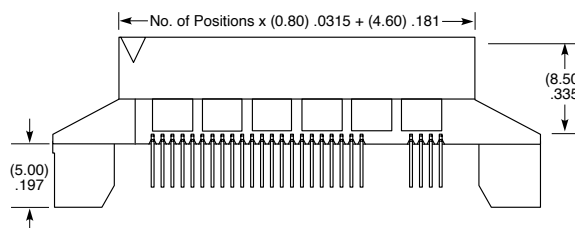

Note:
Some sizes, styles and
options are non-standard,
non-returnable.

View complete specifications at: samtec.com?MEC8-EM

(1.00 mm) .0394" PITCH • MINI EDGE CARD SOCKET

MEC1	1	POSITIONS PER ROW	02	PLATING OPTION	D	NP	OTHER OPTIONS	"X"R
		05, 08, 10, 20, 30, 40, 50, 60, 70		-F = Gold flash on contact, Matte Tin on tail -L = 10 μ" (0.25 μm) Gold on contact, Matte Tin on tail		Leave blank for polarization -NP =No Polarization (05, 08, 20 & 30 positions only)	-A = Alignment Pin metal or plastic at Samtec discretion -K = (7.87 mm) .310" DIA Polyimide film Pick & Place Pad	Leave blank for Tube Packaging -TR =Tape & Reel (05-60 only) -FR = Full Reel Tape & Reel (must order max. quantity per reel; contact Samtec for quantity breaks) (05-60 only)

MEC1

Card Mates:
(1.60 mm) .062" thick card



POSITIONS PER ROW	POLARIZED POSITIONS (No Contact)
05	3, 4
08	5, 6
10	13, 14,
20	15, 16,
30	21, 22
40	31, 32
50	41, 42
60	31, 32, 63 & 64
70	53, 54, 115 & 116

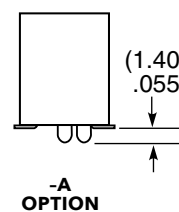
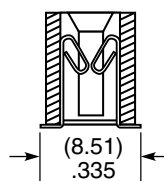
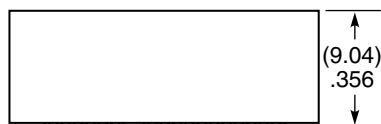
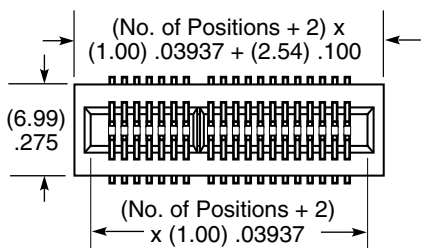

Note:
Some sizes, styles and options are non-standard, non-returnable.

View complete specifications at: samtec.com?MEC1

(1.00 mm) .0394" PITCH • RIGHT-ANGLE/EDGE MOUNT EDGE CARD SOCKET

MEC1	1	POSITIONS PER ROW	02	PLATING OPTION	D	RA1	NP	SL	"X"R
		05, 08, 20, 30, 40, 50, 60, 70		-F = Gold Flash on contact, Matte Tin on tail -L = 10 μ" (0.25 μm) Gold on contact, Matte Tin on tail			Leave blank for polarization -NP = No Polarization (8 thru 30 positions only)		Leave blank for Tube Packaging -TR = Tape & Reel (not available with 70 positions) -FR = Full Reel Tape & Reel (must order max. quantity per reel; contact Samtec for quantity breaks) (not available with 70 positions)

MEC1-RA

Card Mates:
(1.60 mm) .062" thick card

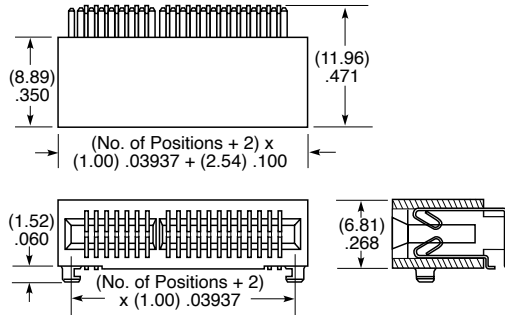
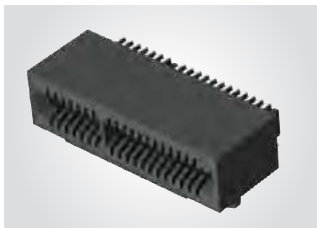

POSITIONS PER ROW	POLARIZED POSITIONS (No Contact)
05	3, 4
08	5, 6
20	15, 16
30	21, 22
40	31, 32
50	41, 42
60	31, 32, 63 & 64
70	53, 54, 115 & 116

View complete specifications at: samtec.com?MEC1-RA

MEC1	1	POSITIONS PER ROW	02	PLATING OPTION	D	EM2	NP	"X"R
		05, 08, 20, 30, 40, 50, 60, 70		-F = Gold Flash on contact, Matte Tin on tail -L = 10 μ" (0.25 μm) Gold on contact, Matte Tin on tail			Leave blank for polarization -NP = No Polarization (8 thru 30 positions only)	Leave blank for Tray Packaging -TR = Tape & Reel (not available with 60 & 70 positions) -FR = Full Reel Tape & Reel (must order max. quantity per reel; contact Samtec for quantity breaks) (not available with 60 & 70 positions)

MEC1-EM

Card Mates:
(1.60 mm) .062" thick card

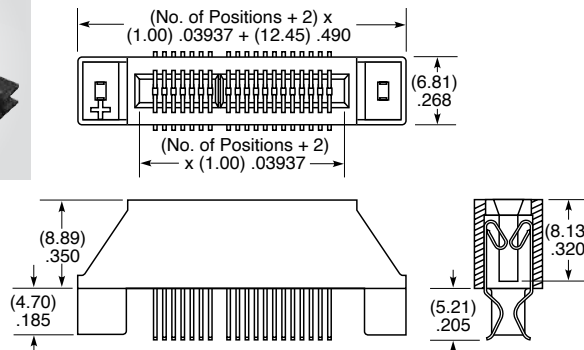
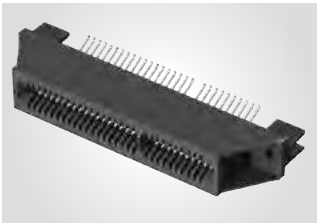

POSITIONS PER ROW	POLARIZED POSITIONS (No Contact)
05	3, 4
08	5, 6
20	15, 16
30	21, 22
40	31, 32
50	41, 42
60	31, 32, 63 & 64
70	53, 54, 115 & 116

Note:
Some sizes, styles and options are non-standard, non-returnable.

View complete specifications at: samtec.com?MEC1-EM

(1.27 mm) .050" PITCH • MINI EDGE CARD SOCKET

MECF	POSITIONS PER ROW	CARD THICKNESS	PLATING OPTION	DV	OPTION	"X"R
	-05, -08, -20, -30, -40, -50	-01 = (1.60 mm) .062" thick card -02 = (2.36 mm) .093" thick card	-L =10 μm (0.25 μm) Gold on contact, Matte Tin on tail		-WT = Weld Tabs (Standard on -02 card thickness, optional on -01 card thickness) -K Polyimide film pick & place pad (-"X"R only)	Leave blank for Tube Packaging -TR = Tape & Reel -FR = Full Reel Tape & Reel (must order max. quantity per reel; contact Samtec for quantity breaks)

MECF

Card Mates:
(1.60 mm) .062"
thick card
(2.36 mm) .093"
thick card

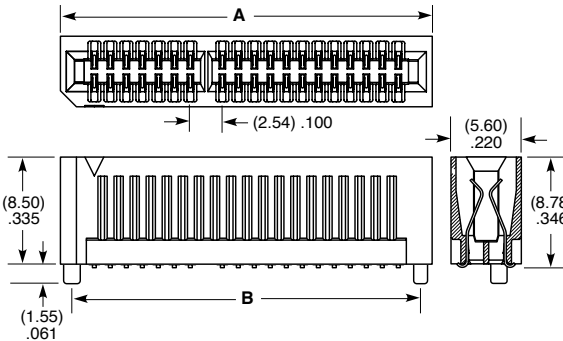

POSITIONS PER ROW	A	B
-05	(10.46) .412	(8.64) .340
-08	(14.27) .562	(12.45) .490
-20	(29.51) 1.162	(27.69) 1.090
-30	(42.21) 1.662	(40.39) 1.590
-40	(54.91) 2.162	(53.09) 2.090
-50	(67.61) 2.662	(65.79) 2.590

POSITIONS PER ROW	POLARIZED POSITIONS (No Contact)
-05	3, 4
-08	5, 6
-20	15, 16
-30	21, 22
-40	31, 32
-50	41, 42

View complete specifications at: samtec.com?MECF-DV

(2.00 mm) .0787" PITCH • MINI EDGE CARD SOCKET

MEC2	POSITIONS PER ROW	CARD THICKNESS	PLATING OPTION	TAIL OPTION	OPTION	"X"R
	-05, -08, -20, -30, -40, -50	-01 = (1.60 mm) .062" thick card -02 = (2.36 mm) .093" thick card (-DV option only)	-L =10 μm (0.25 μm) Gold on contact, Matte Tin on tail	-DV Vertical Surface Mount -TH1 Through-hole	-WT = Weld Tabs (standard on -02 card, optional on -01 card) -K = Polyimide film pick & place pad (-"X"R & -DV only)	Leave blank for Tube Packaging -TR = Tape & Reel (05 thru 30 positions only) (Not available with -TH1) -FR = Full Reel Tape & Reel (must order max. quantity per reel; contact Samtec for quantity breaks) (05 thru 30 positions only) (Not available with -TH1)

MEC2-DV

Card Mates:
(1.60 mm) .062"
thick card
(2.36 mm) .093"
thick card



MEC2-TH

Card Mates:
(1.60 mm) .062"
thick card

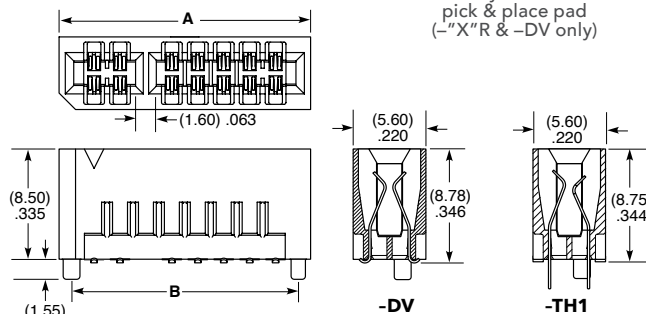

POSITIONS PER ROW	A	B	POSITIONS PER ROW	POLARIZED POSITIONS (No Contact)
-05	(13.40) .528	(11.50) .453	-05	3, 4
-08	(19.40) .764	(17.50) .689	-08	5, 6
-20	(43.40) 1.709	(41.50) 1.634	-20	15, 16
-30	(63.40) 2.496	(61.50) 2.421	-30	21, 22
-40	(83.40) 3.283	(81.50) 3.209	-40	31, 32
-50	(103.40) 4.071	(101.50) 3.996	-50	41, 42

Note:
Some sizes, styles and
options are non-standard,
non-returnable.

View complete specifications at: samtec.com?MEC2-DV & samtec.com?MEC2-TH

PCI EXPRESS® EDGE CARD SOCKETS

(1.00 mm) .0394" PITCH

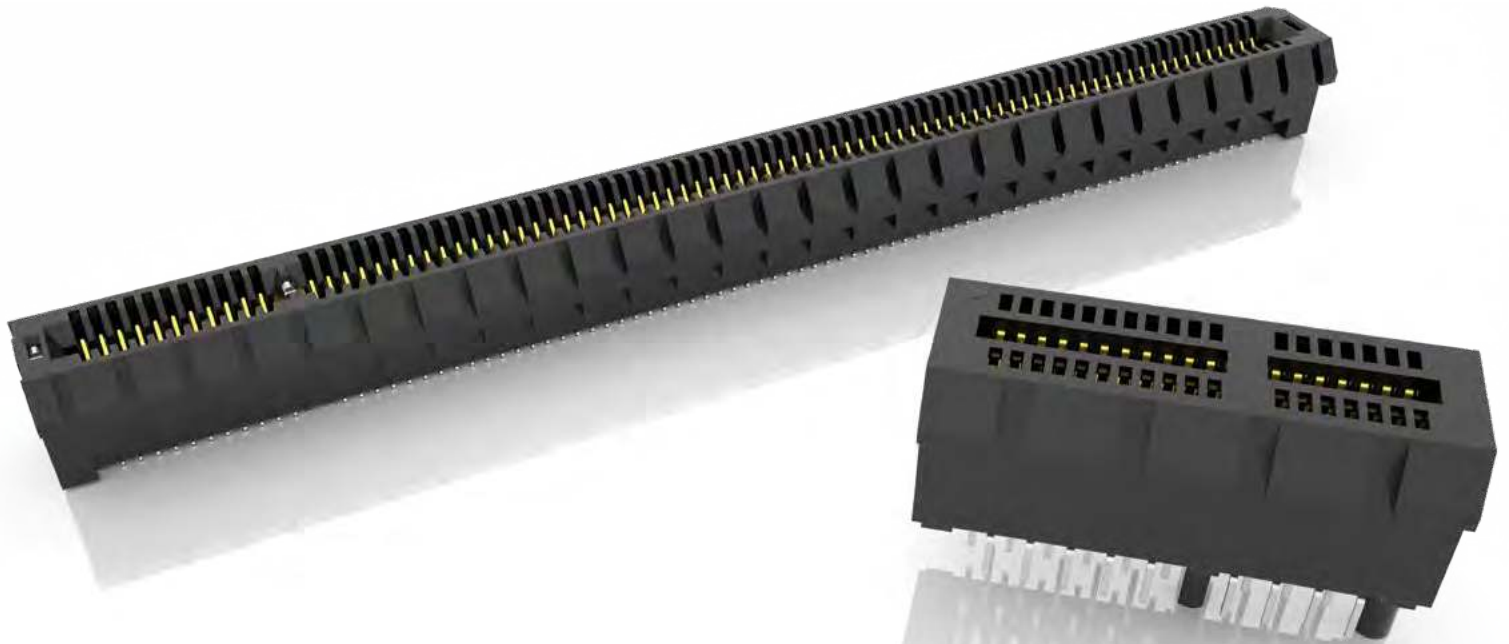

FEATURES & BENEFITS

- 1.00 mm pitch
- Supports 1, 4, 8 and 16 PCI Express® links
- PCIe® 3.0 Solution (PCIe)
- PCIe® 4.0 Solution with low profile design for space savings (PCIe-LP)
- PCIe® 4.0 with slim body design (PCIe-G4)
- PCIe® 5.0 Solution with differential pair signaling (PCIe-G5)
- Vertical, right-angle and edge mount
- Mates with .062" (1.60 mm) thick cards
- Alignment pin and weld tab options

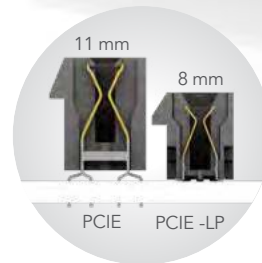

PCIe® 3.0 & 4.0
Edge Card
connectors



PCIe® 4.0 slim body
socket with Edge Rate®
contacts (PCIe-G4)

KEY SPECIFICATIONS

SERIES	TOTAL PINS (LANES)	INSULATOR MATERIAL	CONTACT MATERIAL	OPERATING TEMP RANGE	CURRENT RATING	VOLTAGE RATING	PCIe® COMPATIBILITY
PCIe	36 (x1), 64 (x4), 98 (x8), 164 (x16)	-TH = Black Nylon -EMS2 & -TH = LCP	Phosphor Bronze	-55 °C to +125 °C	2.4 A (2 pins)	215 VAC	3.0
PCIe-LP	36 (x1), 64 (x4), 98 (x8), 164 (x16)	LCP	Phosphor Bronze	-55 °C to +125 °C	2.1 A (2 pins)	215 VAC	4.0
PCIe-G4	36 (x1), 64 (x4), 98 (x8), 164 (x16)	LCP	Copper Alloy	-55 °C to +125 °C	2.2 A (2 pins)	300 VAC	4.0
PCIe-G5	36 (x1), 64 (x4), 98 (x8), 164 (x16)	LCP	Copper Alloy	-55 °C to +125 °C	3.2 A (2 pins)	235 VAC	5.0

(1.00 mm) .0394" PITCH • PCI EXPRESS® CARD SOCKETS

PCIE - **NUMBER OF POSITIONS** - **02** - **PLATING OPTION** - **D** - **TAIL OPTION**

-036, -064, -098, -164

-F
= Gold flash on contact,
Tin on tail

-EMS2
= Edge Mount

-TH
= Through-hole

-RA
= Right-angle

PCIE

Card Mates:
(1.60 mm)
.062" card
Cable Mates:
PCIEC



POSITIONS	A
-036 (x1)	(25.00) .984
-064 (x4)	(39.00) 1.535
-098 (x8)	(56.00) 2.205
-164 (x16)	(89.00) 3.504

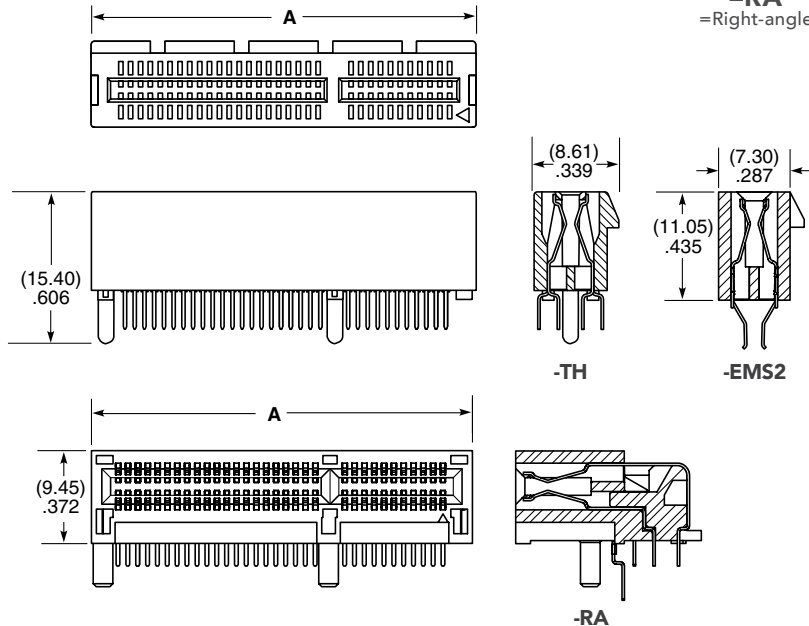

View complete specifications at: samtec.com?PCIE

PCIE - **LP** - **NUMBER OF LANES** - **01** - **PLATING OPTION** - **DV** - **A** - **OPTION** - **PACKAGING**

**-01, -04,
-08, -16**

-F
= Gold Flash on
contact, Matte
Tin on tail

-S
= 30 μ" (0.75 μm)
Gold on contact,
Matte Tin on tail

-WT
= Weld Tab

-K
= Polyimide film
Pick & Place Pad

(For -16 lanes
only leave blank for
Tray Packaging)

-TR
= Tape & Reel
("X"R required with
-01, -04, -08 lanes)

-FR
= Full Reel
Tape & Reel
(must order max.
quantity per reel;
contact Samtec for
quantity breaks)
("X"R required with
-01, -04, -08 lanes)

PCIE-LP

Card Mates:
(1.60 mm)
.062" card
Cable Mates:
PCIEC



PCI-SIG®, PCI Express® and the PCIe® design marks are registered trademarks and/or service marks of PCI-SIG.

Note:
Some lengths, styles and options are non-standard, non-returnable.

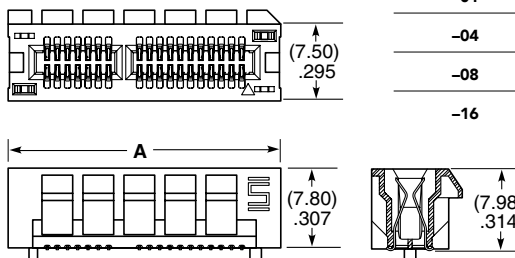

NUMBER OF LANES	A
-01	(26.60) 1.047
-04	(40.60) 1.598
-08	(57.60) 2.268
-16	(90.60) 3.567

View complete specifications at: samtec.com?PCIE-LP

(1.00 mm) .0394" PITCH • PCI EXPRESS® 4.0 SOCKET

PCIE	G4	NUMBER OF LANES	01	PLATING OPTION	DV	OPTION 1	OPTION 2	PACKAGING
------	----	-----------------	----	----------------	----	----------	----------	-----------

-01, -04,
-08, -16

-F
= Gold flash on contact, Matte Tin on tail

-S
= 30 μ" (0.76 μm) Gold on contact, Matte Tin on tail

-A
= Alignment Pin (Not available with -WT)

-WT
= Weld Tab (Not available with -A)

-K
= (7.00 mm) .275" DIA Polyimide Pick & Place Pad

(For -16 lanes only leave blank for Tray Packaging)

-TR
= Tape & Reel ("X"R required with -01, -04, -08 lanes)

-FR
= Full Reel Tape & Reel (must order max. quantity per reel; contact Samtec for quantity breaks) ("X"R required with -01, -04, -08 lanes)

PCIE-G4
Card Mates:
(1.60 mm)
.062" card

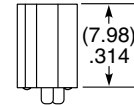
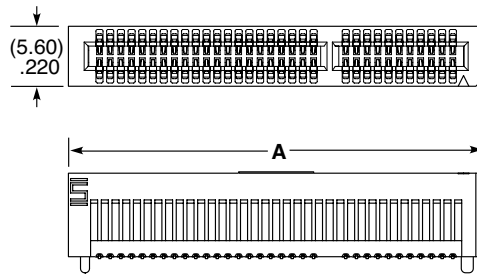

NUMBER OF LANES	A
-01	(24.80) .976
-04	(38.80) 1.528
-08	(55.80) 2.197
-16	(88.80) 3.496

View complete specifications at: samtec.com?PCIE-G4

(1.00 mm) .0394" PITCH • PCI EXPRESS® 5.0 SOCKET

PCIE	G5	NUMBER OF LANES	01	PLATING OPTION	TYPE	OPTION	PACKAGING
------	----	-----------------	----	----------------	------	--------	-----------

-01, -04,
-08, -16

-F
= Gold flash on contact, Matte Tin on tail

-S
= 30 μ" (0.76 μm) Gold on contact, Matte Tin on tail

-DP-A
= Vertical

-EM
= Edge Mount

-WT
= Weld Tab

(For -16 lanes only leave blank for Tray Packaging)

-TR
= Tape & Reel ("X"R required with -01, -04, -08 lanes)

-FR
= Full Reel Tape & Reel (must order max. quantity per reel; contact Samtec for quantity breaks) ("X"R required with -01, -04, -08 lanes)

PCIE-G5
Card Mates:
(1.60 mm)
.062" card

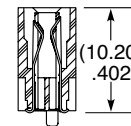
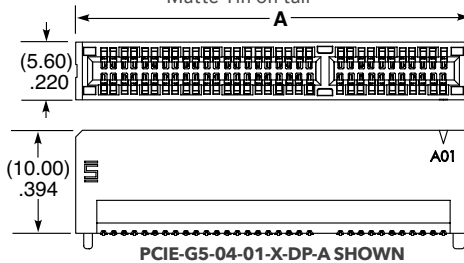

NUMBER OF LANES	A	B
-01	(24.40) .961	(27.40) 1.079
-04	(38.40) 1.512	(41.40) 1.630
-08	(55.40) 2.181	(58.40) 2.299
-16	(88.40) 3.480	(91.40) 3.598

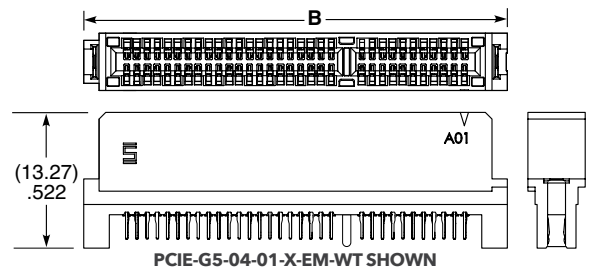

PCIE-G5-04-01-X-EM-WT SHOWN

PCI-SIG®, PCI Express® and the PCIe® design marks are registered trademarks and/or service marks of PCI-SIG.

Note:
Some lengths, styles and options are non-standard, non-returnable.

View complete specifications at: samtec.com?PCIE-G5

HIGH-SPEED BACKPLANE SYSTEMS

HIGH-DENSITY • DESIGN FLEXIBILITY • HIGH RELIABILITY



82-83

NovaRay®

Micro Rugged Backplane Header and Socket (NVBF, NVBM)..... 83

84-89

ExaMAX®

ExaMAX® Vertical & Right-Angle Headers (EBTM) 85
 ExaMAX® Right-Angle Receptacles (EBTF-RA) 86
 ExaMAX® Direct-Mate Orthogonal Headers (EBDM-RA) 86
 Power Modules for ExaMAX® (EPTT, EPTS) 87
 Guidance Modules for ExaMAX® (EGBM, EGBF) 87
 ExaMAX® Cable Systems (EBCM, EBCF, EBCB, EBCL) 88-89

90-92

XCede® HD

XCede® HD Backplane Headers & Receptacles (HDTM, HDTF) 91-92
 XCede® HD Power Modules (HPTS, HPTT) 92

MICRO RUGGED BACKPLANE SYSTEM

(0.80 mm) .0315" x (1.80 mm) .071" PITCH

PAM4

112
Gbps

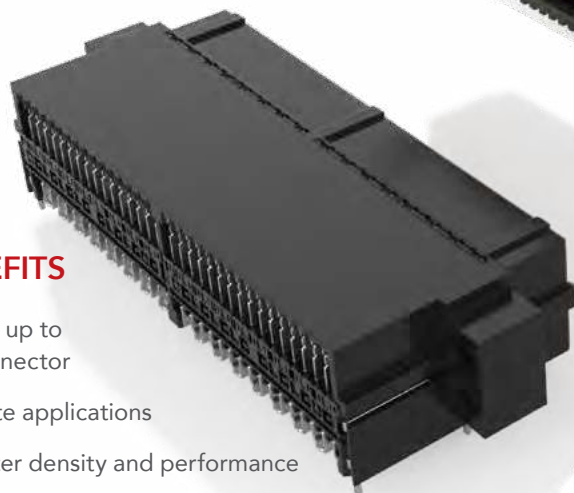

FEATURES & BENEFITS

- Ultra-high density with up to 128 DPs in a single connector
- Designed for blind mate applications
- Surface mount for better density and performance
- Innovative wafer design eliminates intra-pair skew
- Configurable signal banks for design flexibility
- Offset footprint for optimal signal integrity performance
- Large continuous ground blades between and surrounding the differential pairs eliminates resonances
- Optional guidance and keying
- Standard weld tabs for a secure connection to the board



Ultra-high density; single-ended or differential pair wafers



Precision insert molded contact system with 2.50 mm wiper



IN DEVELOPMENT: Flyover® cable assembly for extended signal reach

KEY SPECIFICATIONS (NVBM/NVBF)

INSULATOR MATERIAL	CONTACT MATERIAL	PLATING	OPERATING TEMP RANGE	CURRENT RATING	VOLTAGE RATING
Black LCP	Copper Alloy	Au or Sn over 50 μ" (1.27 μm) Ni	Testing Now!	Testing Now!	Testing Now!

0.80 mm x 1.80 mm PITCH • MICRO RUGGED BACKPLANE HEADER & SOCKET

SERIES	STYLE	NO. OF COLUMNS	ORIENTATION	PLATING OPTION	SOLDER TYPE	GUIDANCE	KEYING	"X"R
NVBF Socket	-DP = 4 Pairs per wafer	-32	-VT = Vertical (NVBF)	-S = 30 μm (0.76 μm) Gold on contact area, Matte Tin on solder tail	-2 = Lead-Free Solder Charge	(Leave Blank for no Guidance)	-N = No Key	-TR = Tape & Reel
NVBM Terminal			-RA = Right-Angle (NVBM)			-L = Left Guidance	-A thru -H = Position of flat on Key (See Table) (Only available with Guidance)	-FR = Full Reel Tape & Reel (must order maximum quantity per reel; contact Samtec for quantity breaks)
						-R = Right Guidance		
						-B = Both		

PRELIMINARY

NVBF-VT
Board Mates:
NVBM-RA



NO. OF COLUMNS	A	B
-32	(72.00) 2.835	(71.75) 2.825

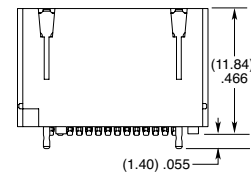
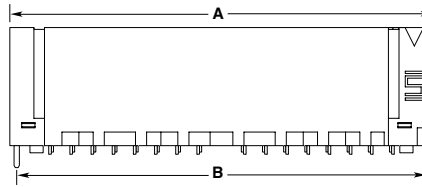
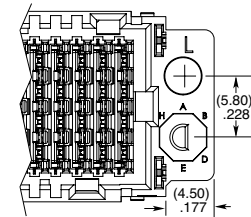
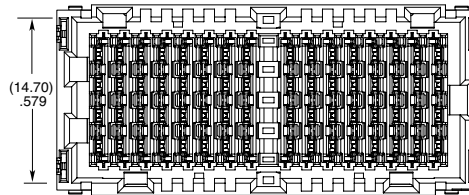

KEYING (-VT)								
-L / -R / -B	-A	-B	-C	-D	-E	-F	-G	-H

Notes:
Some sizes, styles and options are non-standard, non-returnable

View complete specifications at: samtec.com?NVBF

NVBM-RA
Board Mates:
NVBF-VT

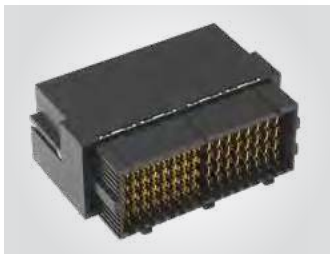

PRELIMINARY

NO. OF COLUMNS	A	B	C
-32	(67.90) 2.673	(72.00) 2.835	(69.80) 2.748

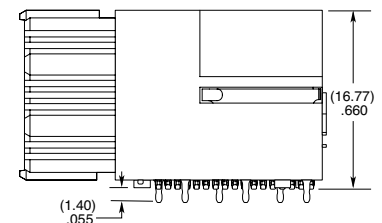
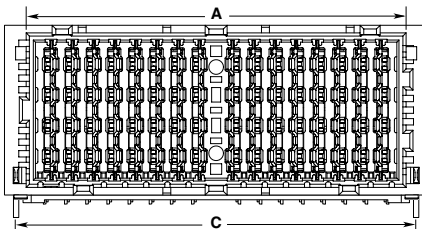
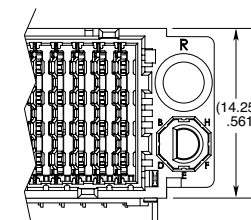
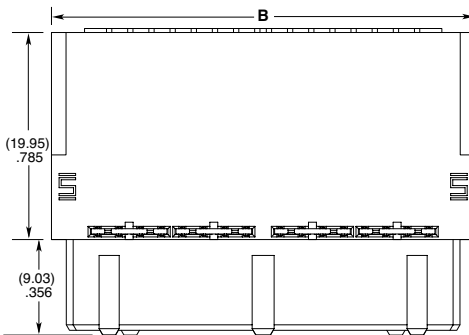

KEYING (-RA)								
-L / -R / -B	-A	-B	-C	-D	-E	-F	-G	-H

View complete specifications at: samtec.com?NVBM

ExaMAX[®]

HIGH-SPEED BACKPLANE CONNECTOR & CABLE SYSTEMS

(2.00 mm) .0787" PITCH

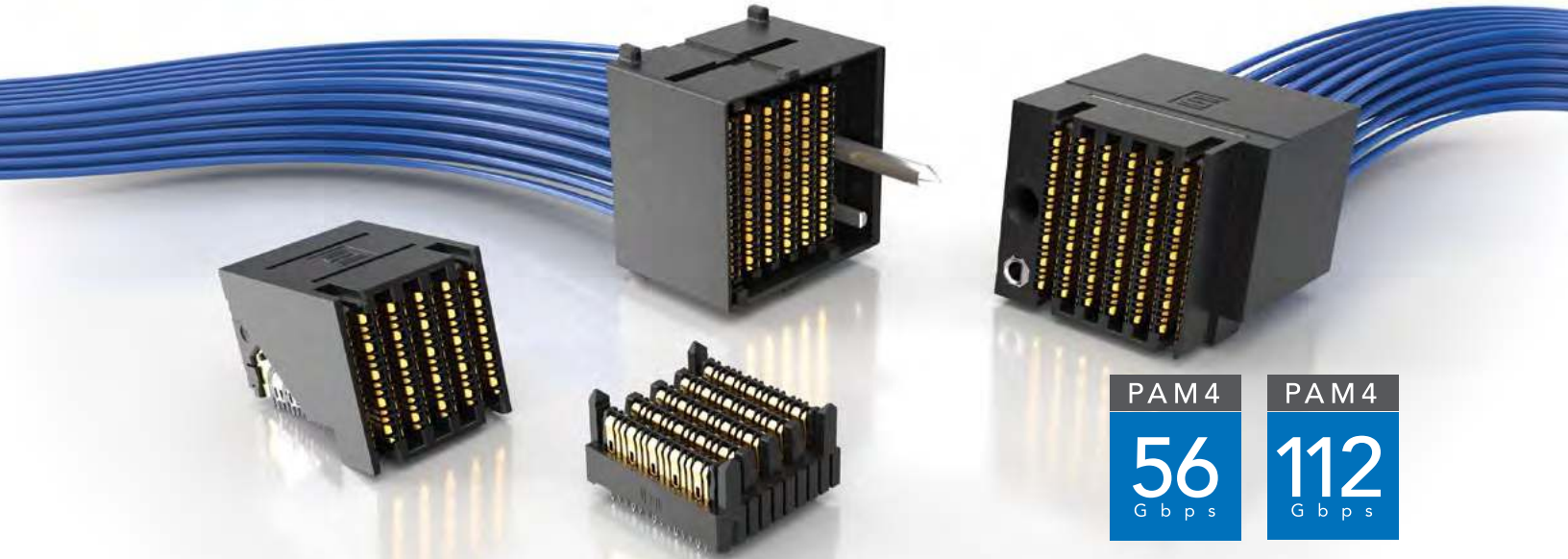

FEATURES & BENEFITS

ExaMAX[®] High-Speed Backplane System

- Meets a variety of industry specifications
- Exceeds OIF CEI-28G-LR specification for 28 Gbps standards
- 24 - 72 pair designs (4 and 6 pairs; 6, 8, 10 and 12 columns)
- Wafer design includes one sideband signal per column
- Press-fit tails provide a reliable electrical connection

ExaMAX[®] High-Speed Backplane Cable Assemblies

- 30 & 34 AWG Eye Speed[®] Ultra Low Skew Twinax Cable offers improved signal integrity, increased flexibility and routability
- Highly customizable with modular flexibility
- Reduce costs due to lower layer counts
- Multiple end options available
- Eye Speed[®] Thinax[™] ultra performance twinax cable version in development

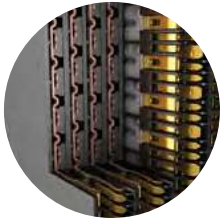

Staggered Differential Pair Design



Two Reliable Points of Contact with a 2.4 mm Wipe

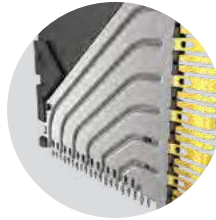

Shielded Wafer Design Reduces Crosstalk



Traditional, Coplanar and Direct Mate Orthogonal



In Development: 8 Pairs for Greater Design Flexibility

KEY SPECIFICATIONS

SERIES	INSULATOR MATERIAL	CONTACT MATERIAL	PLATING	OPERATING TEMP RANGE	CURRENT RATING	VOLTAGE RATING	LEAD-FREE SOLDERABLE
EBTM/EBTF/EBDM	Liquid Crystal Polymer	Copper Alloy	Sn or Au over 50 μ" (1.27 μm) Ni	-55 °C to +105 °C	4 A per pin	150 VAC	Yes
EPTT/EPTS	High Temperature Thermoplastic	Copper Alloy	Sn or Au over 50 μ" (1.27 μm) Ni	-55 °C to +105 °C	14.1 A per pin	150 VAC	Yes
EBCM/EBCF	Liquid Crystal Polymer	Copper Alloy	Au over 50 μ" (1.27 μm) Ni	-40 °C to +105 °C	3.6 A per pin	125 VAC	N/A

(2.00 mm) .0787" PITCH • VERTICAL & RIGHT-ANGLE HEADERS

EBTM	NO. OF PAIRS PER COLUMN	COLUMNS	COLUMN PITCH	PLATING	ORIENTATION	1	GUIDANCE	KEYING
------	-------------------------	---------	--------------	---------	-------------	---	----------	--------

-4
= 4 Pairs

-6
= 6 Pairs

-06, -08, -10, -12
(-12 column only available in -6 pairs)

-2.0
= (2.0 mm)
.0787"

-S
= 30 μm
(0.76 μm)
Gold on contact area,
Matte Tin on tail

-VT
= Vertical

-RA
= Right-Angle

(Leave Blank for no Guidance)

-L
= Left Guidance

-R
= Right Guidance

(Only available with -L or -R Guidance)
(Leave Blank for no Keying)

-A thru -H
= Position of flat on Key
(See Table)

EBTM-VT
Board Mates:
EBTF-RA

Cable Mates:
EBCF

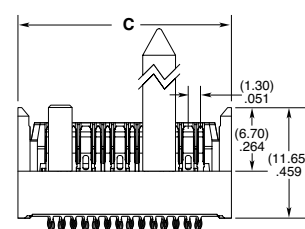
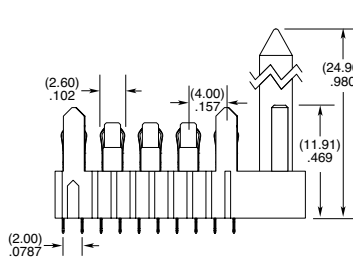
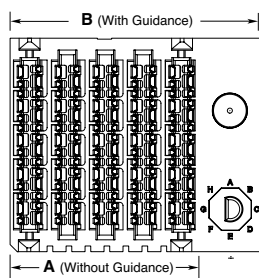

KEYING (-VT)								
-L / -R	-A	-B	-C	-D	-E	-F	-G	-H

COLUMNS	A	B
-06	(11.90) .469	(18.35) .722
-08	(15.90) .626	(22.35) .880
-10	(19.90) .783	(26.35) 1.037
-12	(23.90) .941	(30.35) 1.195

NO. OF PAIRS PER COLUMN	C
-4	(22.50) .886
-6	(29.70) 1.169

View complete specifications at: samtec.com?EBTM

EBTM-RA
Board Mates:
EBTF-RA

Cable Mates:
EBCF

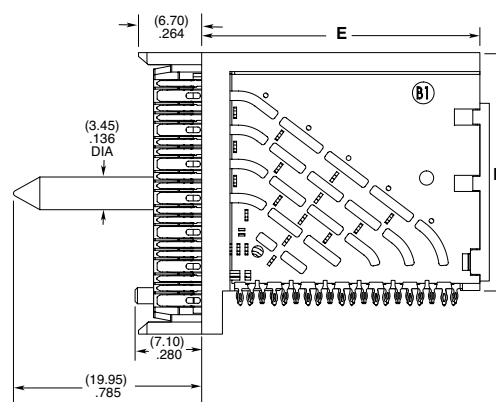
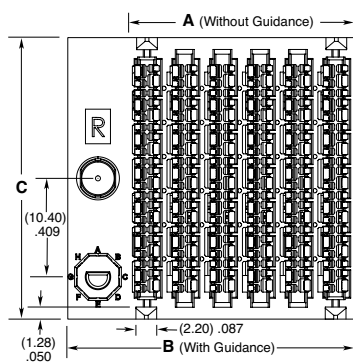

KEYING (-RA)								
-L / -R	-A	-B	-C	-D	-E	-F	-G	-H

COLUMNS	A	B
-06	(11.90) .469	(18.35) .722
-08	(15.90) .626	(22.35) .880
-10	(19.90) .783	(26.35) 1.037
-12	(23.90) .941	(30.35) 1.195

NO. OF PAIRS PER COLUMN	C	D	E
-4	(22.50) .886	(17.90) .705	(23.30) .917
-6	(29.70) 1.169	(25.10) .988	(30.50) 1.201

Notes:
Some lengths, styles and options are non-standard, non-returnable.

ExaMAX[®] is a registered trademark of AFCI.

View complete specifications at: samtec.com?EBTM-RA

(2.00 mm) .0787" PITCH • RIGHT-ANGLE SOCKET & DIRECT-MATE ORTHOGONAL

EBTF	NO. OF PAIRS PER COLUMN	COLUMNS	COLUMN PITCH	PLATING	RA	1	GUIDANCE	KEYING
	-4 = 4 Pairs -6 = 6 Pairs	-06, -08, -10, -12 (-12 column only available in -6 pairs)	-2.0 = (2.0 mm) .0787"	-S = 30 μ" (0.76 μm) Gold on contact area, Matte Tin on tails			(Leave Blank for no Guidance) -L = Left Guidance -R = Right Guidance	(Only with -L or -R Guidance; Leave Blank for no Keying) -A thru -H = Position of Flat on Key (See Table)

EBTF-RA
Board Mates:
EBTM,
EBDM-RA

Cable Mates:
EBCM

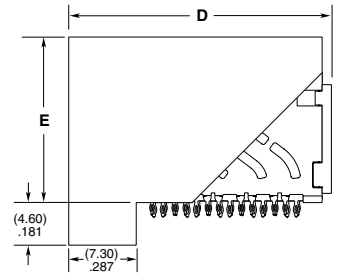
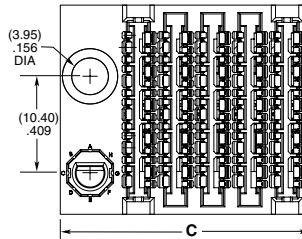
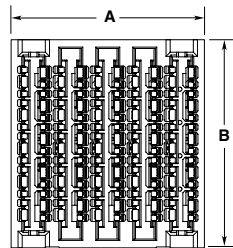

KEYING (-RA)								
-L / -R	-A	-B	-C	-D	-E	-F	-G	-H

NO. OF COLUMNS	A	C
-06	(12.90) .508	(18.85) .742
-08	(16.90) .665	(22.85) .900
-10	(20.90) .823	(26.85) 1.057
-12	(24.90) .980	(30.85) 1.215

NO. OF PAIRS PER COLUMN	B	D	E
-4	(22.50) .886	(28.40) 1.118	(17.90) .705
-6	(29.70) 1.169	(35.60) 1.402	(25.10) .988

View complete specifications at: samtec.com?EBTF-RA

EBDM	PAIRS	COLUMNS	2.0	PLATING	RA	1	GUIDANCE	SCREW MOUNT
	-6 = 6 Pairs	-06, -08, -10, -12		-S = 30 μ" (0.76 μm) Gold on contact area, Matte Tin on tails			(Leave Blank for no Pin) -G = Guide Pin	(Leave Blank for no Screw Mount) -S = Screw Mount

EBDM-RA
Board Mates:
EBTF-RA

Cable Mates:
EBCF

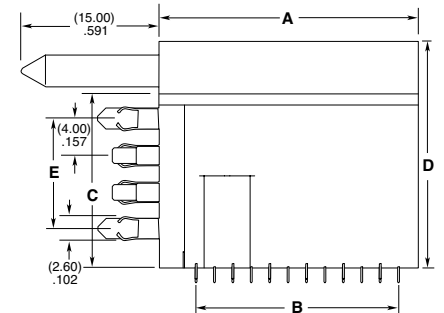
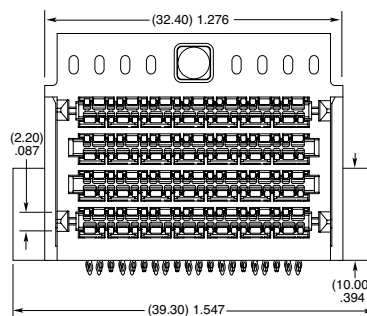

COLUMNS	A	B	C (without -G)	D (with -G)	E
-06	(16.15) .636	(10.00) .394	(15.00) .591	(20.65) .813	(8.00) .315
-08	(20.15) .793	(14.00) .551	(19.00) .748	(24.65) .970	(12.00) .472
-10	(24.15) .951	(18.00) .709	(23.00) .906	(28.65) 1.128	(16.00) .630
-12	(28.15) 1.108	(22.00) .866	(27.00) 1.063	(32.65) 1.285	(20.00) .787

Notes:
Some lengths, styles and options are non-standard, non-returnable.

ExaMAX[®] is a registered trademark of AFCI.

View complete specifications at: samtec.com?EBDM-RA

ExaMAX[®] POWER MODULES

(2.00 mm) .0787" PITCH TERMINAL POWER MODULES



EPTT
Mates with:
EPTS

EPTT	POSITIONS PER ROW	PLATING	HEIGHT	D	ORIENTATION
	-2 = 4 Positions	-P = Palladium with flash Gold on contacts, Matte Tin on tails	-11.5 = (11.50 mm) .453"		-RA = Right-Angle

(2.00 mm) .0787" PITCH SOCKET POWER MODULES



EPTS
Mates with:
EPTT

EPTS	POSITIONS PER ROW	PLATING	D	ORIENTATION	PIN STAGING
	-2 = 4 Positions	-P = Palladium with flash Gold on contacts, Matte Tin on tails		-VT = Vertical -RA = Right-Angle	-01 thru -06 (-RA available with -04 only. Visit website for dimensions.)

View complete specifications at: samtec.com?EPTT & samtec.com?EPTS

ExaMAX[®] GUIDE MODULES

TERMINAL GUIDE MODULES



EGBM
Mates with:
EGBF
Insulator Material:
Zinc Alloy

EGBM	ORIENTATION	THREADING	LENGTH	CARD SPACING
	-VT = Vertical -RA = Right-Angle	Leave Blank for -RA -1 = External -2 = Internal (25.3 Length only)	Leave Blank for -RA -18.3 = 18.30 mm (.720") -25.3 = 25.30 mm (.996")	-20 = 20 mm (.787")

SOCKET GUIDE MODULES



EGBF
Mates with:
EGBM
Insulator Material:
Zinc Alloy

EGBF	ORIENTATION	CARD SPACING
	-RA = Right-Angle	-20 = 20 mm (.787")

Notes:

Some lengths, styles and options are non-standard, non-returnable.

ExaMAX[®] is a registered trademark of AFCEI.

View complete specifications at: samtec.com?EGBM & samtec.com?EGBF

(2.00 mm) .0787" PITCH • BACKPLANE CABLES

EBCM	GAUGE/ SIG. MAP	PAIRS PER COLUMN	COLUMNS	END 1 PIN	END 1 GUIDE	END 1 KEY	CABLE LENGTH	END 2 PIN	END 2	END 2 KEY
Cable Header	-1 = 34 AWG/Tx to Rx Sig. Map -2 = 30 AWG/Tx to Rx Sig. Map -3 = 34 AWG/1:1 Sig. Map -4 = 30 AWG/1:1 Sig. Map	-4 = 4 Pairs -6 = 6 Pairs	-04, -06, -08, -10, -12, -14, -16	-1 = Standard	-L = Left Guidance -R = Right Guidance	-A thru -H = Position of Flat on Key (See Table) -N = No Key	-"XX" = Length in Inches 06" (152.4 mm) minimum	-1 = Standard	-L = Male, Left Guidance -R = Male, Right Guidance -FL = Female, Right-angle Left Guidance (-3 & -4 Signal Map only) -FR = Female, Right-angle Right Guidance (-3 & -4 Signal Map only) -FV = Female, Vertical (-3 & -4 Signal Map only)	(Leave Blank for -FV End 2) -A thru -H = Position of Flat on Key (See Table) -N = No Key

NO. OF COLUMNS	A
-04	(17.45) .687
-06	(21.45) .845
-08	(25.45) 1.002
-10	(29.45) 1.159
-12	(33.45) 1.317
-14	(37.45) 1.474
-16	(41.45) 1.632

PAIRS PER COLUMN	B
-4	(24.80) .976
-6	(32.00) 1.260



EBCM
Mates with:
EBCF, EBTF
Retention Bracket:
EBCB

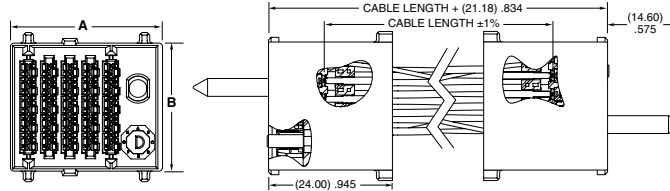

END 1: -L-G SHOWN END 2

View complete specifications at: samtec.com?EBCM

EBCF	GAUGE/ SIG. MAP	PAIRS / COLUMN	COLUMNS	END 1	END 1 PIN	CABLE LENGTH	END 2 OPTION	END 2 PIN	END 2 GUIDE	END 2 KEY
Cable Socket	-1 = 34 AWG/Tx to Rx Sig. Map -2 = 30 AWG/Tx to Rx Sig. Map -3 = 34 AWG/1:1 Sig. Map -4 = 30 AWG/1:1 Sig. Map	-4 = 4 Pairs -6 = 6 Pairs	-04, -06, -08, -10, -12, -14, -16	-V = Vertical Latch	-1 = Standard	-"XX" = Length in Inches 06" (152.4 mm) minimum	-V = Vertical Latch -R = Right-Angle	-1 = Standard	(-R End Only) -L = Left Guidance -R = Right Guidance	(Leave Blank for no Key; -R End Only) -A thru -H = Position of Flat on Key (See Table)

NO. OF COLUMNS	A	C	E
-04	(10.60) .417	(14.85) .585	(19.15) .754
-06	(14.60) .575	(18.85) .742	(23.15) .911
-08	(18.60) .732	(22.85) .900	(27.15) 1.069
-10	(22.60) .890	(26.85) 1.057	(31.15) 1.226
-12	(26.60) 1.047	(30.85) 1.530	(35.15) 1.699
-14	(30.60) 1.205	(34.85) 1.372	(39.15) 1.541
-16	(34.60) 1.362	(38.85) 1.530	(43.15) 1.699

PAIRS PER COLUMN	B	D
-4	(23.00) .906	(22.70) .894
-6	(30.20) 1.189	(29.90) 1.177

KEYING								
-L / -R	-A	-B	-C	-D	-E	-F	-G	-H



EBCF
Mates with:
EBCM, EBTM
Latching Shroud:
EBCL

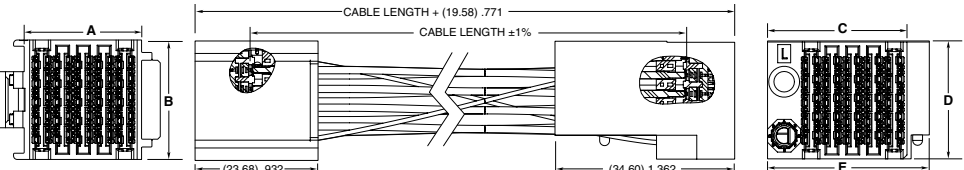

END 1: -V SHOWN END 2: -L-G SHOWN

Notes:
Some lengths, styles and options are non-standard, non-returnable.

ExaMAX[®] is a registered trademark of AFCEI.

View complete specifications at: samtec.com?EBCF

PANEL RETENTION BRACKETS & LATCHING SHROUDS

EBCB	NO. OF PAIRS	NO. OF COLUMNS	NO. OF BANKS	MOUNTING OPTION
Panel Retention Bracket	-4 = 4 Pairs -6 = 6 Pairs	-04, -06, -08, -10, -12, -14, -16 (-04, -06 only available with -1-S)	-1, -2, -4 (-2 & -4 banks available with -08, -10, -12, -14, -16 columns only)	(Leave Blank for Standard) -S = Side Lugs (-1 Bank Only)

EBCB

Use with:
EBCF, EBCM, EBTf-RA

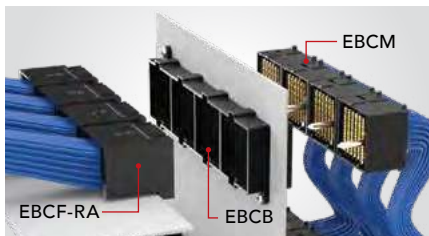

EBCM Cable Assembly Locks into EBCB Retention Bracket

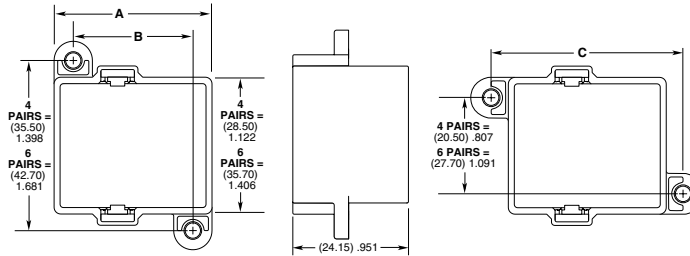

EBCB-X-XX-1 SHOWN

EBCB-X-XX-1-S SHOWN

NO. OF COLUMNS	C
-04	(27.95) 1.100
-06	(31.95) 1.258
-08	(35.95) 1.415
-10	(39.95) 1.573
-12	(43.95) 1.730
-14	(47.95) 1.888
-16	(51.95) 2.045

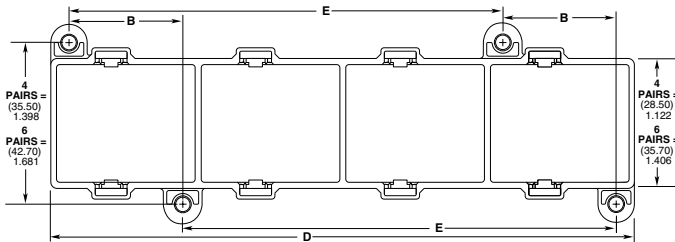

EBCB-X-XX-4 SHOWN

NO. OF COLUMNS	A		B		D 4 Bank	E 4 Bank
	1 Bank	2 Bank	1 or 4 Bank	2 Bank		
-04	(20.95) .825	N/A	N/A	N/A	N/A	N/A
-06	(24.95) .982	N/A	N/A	N/A	N/A	N/A
-08	(28.95) 1.140	(56.65) 2.230	(20.95) .825	(48.65) 1.915	(112.05) 4.411	(83.10) 3.272
-10	(32.95) 1.297	(64.65) 2.545	(24.95) .982	(56.65) 2.230	(128.05) 5.041	(95.10) 3.744
-12	(36.95) 1.455	(72.65) 2.860	(28.95) 1.140	(64.65) 2.545	(144.05) 5.671	(107.10) 4.217
-14	(40.95) 1.612	(80.65) 3.175	(32.95) 1.297	(72.65) 2.860	(160.05) 6.301	(119.10) 4.689
-16	(44.95) 1.770	(88.65) 3.490	(36.95) 1.455	(80.65) 3.175	(176.05) 6.931	(131.10) 5.161

View complete specifications at: samtec.com?EBCB

EBCL	NO. OF PAIRS	NO. OF COLUMNS
Vertical Latching Shroud	-4, -6	-06, -08, -10, -12 (-12 column only available in -6 pairs)

EBCL

Use with:
EBCF, EBTM

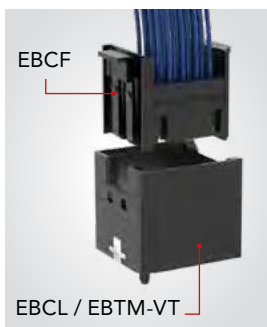

NO. OF COLUMNS	A	B
-06	(22.40) .882	(18.66) .734
-08	(26.40) 1.039	(22.66) .892
-10	(30.40) 1.197	(26.66) 1.050
-12	(34.40) 1.354	(30.66) 1.207

NO. OF PAIRS	C	D	E
-4	(26.20) 1.031	(11.45) .451	(21.50) .846
-6	(33.40) 1.315	(15.05) .593	(28.70) 1.130

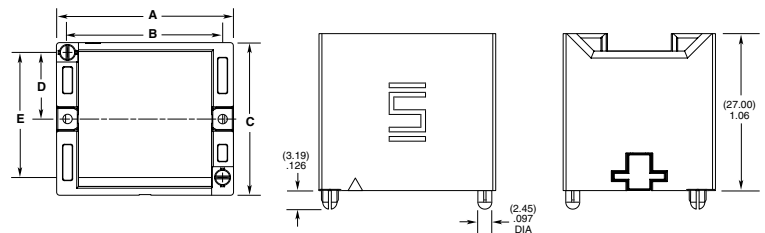

Notes:
Some lengths, styles and options are non-standard, non-returnable.

ExaMAX® is a registered trademark of AFCI.

View complete specifications at: samtec.com?EBCL

HIGH-DENSITY BACKPLANE HEADERS & SOCKETS

(1.80 mm) .071" PITCH

16
Gbps

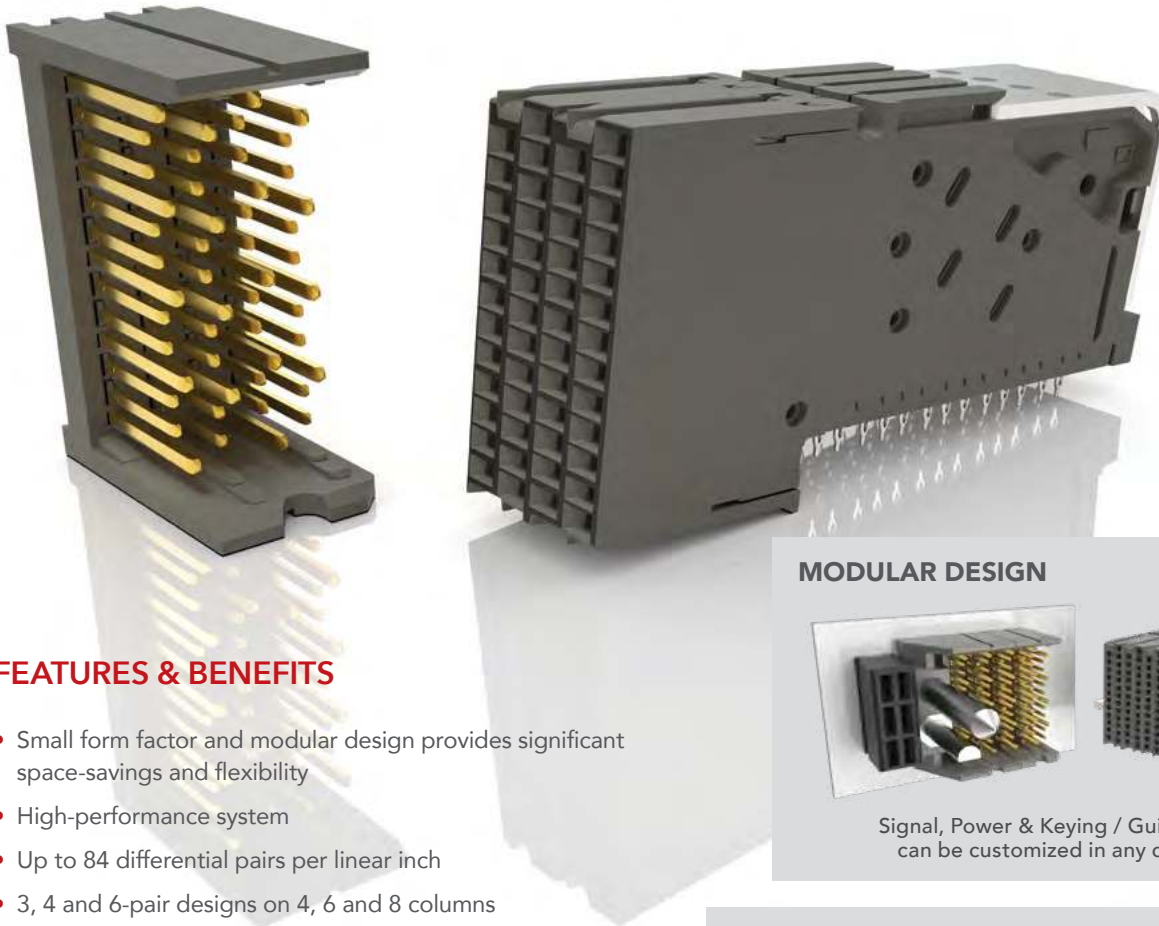

FEATURES & BENEFITS

- Small form factor and modular design provides significant space-savings and flexibility
- High-performance system
- Up to 84 differential pairs per linear inch
- 3, 4 and 6-pair designs on 4, 6 and 8 columns
- Integrated power, guidance, keying and side walls available
- 85 Ω and 100 Ω options
- Combine any configuration of modules to create one integrated receptacle (BSP Series); corresponding terminal modules are individually mounted to the backplane. Visit samtec.com?BSP or contact HSBP@samtec.com
- Press-fit extraction and insertion tool options; please visit samtec.com/tooling for details

MODULAR DESIGN

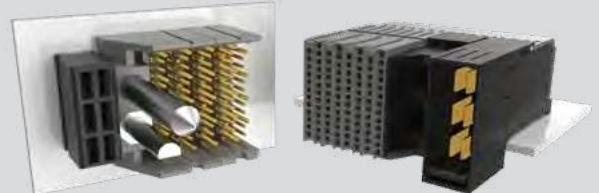

Signal, Power & Keying / Guidance options can be customized in any configuration

HIGH-DENSITY, SMALL FORM FACTOR



XCede[®] HD
Up to 84 pairs per linear inch



Traditional Backplane
Up to 76 pairs per linear inch

(Both shown with six 4-pair, 8 column receptacles)

KEY SPECIFICATIONS

SERIES	INSULATOR MATERIAL	CONTACT MATERIAL	PLATING	OPERATING TEMP RANGE	CURRENT RATING	VOLTAGE RATING
HDTM/HDTF	LCP	Phosphor Bronze (HDTM) Copper Alloy (HDTF)	Au or Sn over 50 μ" (1.27 μm) Ni	-40 °C to + 105 °C	1.5 A per contact	48 VAC
HPTS/HPTT	LCP	Copper Alloy	Au or Sn over 50 μ" (1.27 μm) Ni	-40 °C to + 105 °C	10 A per blade	48 VAC

(1.80 mm) .071" PITCH • HIGH-DENSITY BACKPLANE HEADER

HDTM	PAIRS	NO. OF COLUMNS	TAIL SIZE	S	VT	SIDE WALLS	GUIDANCE	STAGE COMBO	KEYING
	-3, -4, -6 =Pairs Per Column	-04, -06, -08	-1 =(.4495 mm) .0177" Drill -2 =(.5511 mm) .0217" Drill			-0 = Open (No Walls) -1 = Left -2 = Right -4 = Left Polarizing with left guidance (-4 Pairs N/A) -5 = Right Polarizing with right guidance (-4 Pairs N/A)	-4 or -5 Polarizing Only; Leave Blank for No Guidance -L = Left Side Guide Pin (-4 Pairs N/A) -R = Right Side Guide Pin (-4 Pairs N/A)	-1 = 3 mm Wipe Signal / 4 mm Wipe Ground -2 = 2 mm Wipe Signal / 4 mm Wipe Ground -3 = 3 mm Wipe Signal / 3 mm Wipe Ground -4 = 2 mm Wipe Signal / 3 mm Wipe Ground -5 = 2 mm Wipe Signal / 2 mm Wipe Ground	-4 or -5 Polarizing Only; Leave Blank for No Keying -A thru -H = Position of Flat on Key (See Table)

HDTM Board Mates:
HDTF, BSP

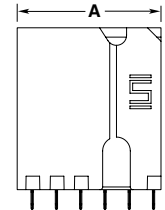
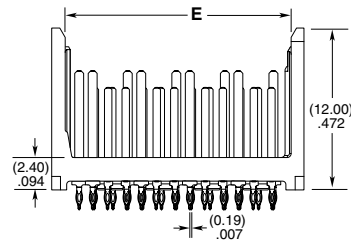
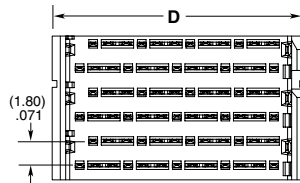
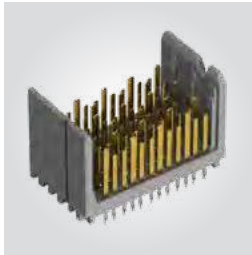

HDTM-4-06-1-S-VT-0-1 SHOWN

NO. OF COLUMNS	A			C	
	No Walls	Left Wall	Right Wall	Left Polarize	Right Polarize
-04	(7.06) .278	(8.20) .323	(8.06) .317	N/A	N/A
-06	(10.66) .420	(11.80) .465	(11.66) .459	(17.14) .675	(16.65) .656
-08	(14.26) .561	(15.40) .606	(15.26) .600	(20.74) .817	(20.25) .797

PAIRS PER COLUMN	D	E
	Standard Wall	
-03	(15.10) .594	(13.15) .518
-04	(18.70) .736	(16.75) .659
-06	(25.90) 1.020	(23.95) .943

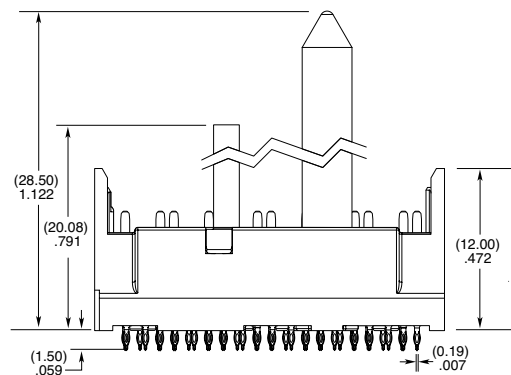
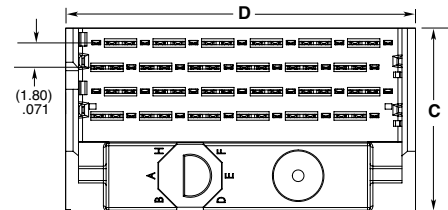

HDTM-6-04-X-X-VT-4-L-X-A SHOWN

KEYING								
-L / -R	-A	-B	-C	-D	-E	-F	-G	-H

Notes:
Some lengths, styles and options are non-standard, non-returnable.
XCede® is a registered trademark of Amphenol.

View complete specifications at: samtec.com?HDTM

(1.80 mm) .071" PITCH • HIGH-DENSITY BACKPLANE RECEPTACLE

HDTF	PAIRS PER COLUMN	NO. OF COLUMNS	PLATING	RA	WAFERS	IMPEDANCE
	-3, -4, -6	-04, -06, -08	-S = 30 μ" (0.76 μm) Gold on Contact Area, Matte Tin on Tail		-LC = Standard -HS = High-Speed	-100 = 100 Ω -085 = 85 Ω

HDTF Board Mates:
HDTM

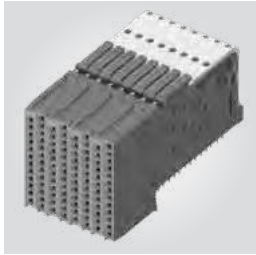
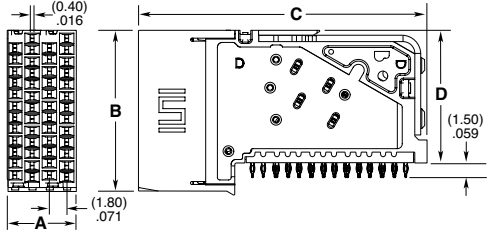
NO. OF COLUMNS	A	PAIRS PER COLUMN	B	C	D
-04	(7.2) .283	-3	(12.8) .504	(26.0) 1.02	(9.9) .390
-06	(10.8) .425	-4	(16.4) .646	(29.4) 1.16	(13.5) .531
-08	(14.4) .567	-6	(23.6) .929	(36.6) 1.44	(20.7) .815

View complete specifications at: samtec.com?HDTF

(3.20 mm) .126" PITCH • POWER MODULES

HPTS	BODY HEIGHT	PLATING	D	ORIENTATION
= Socket	Based on Pair Count of Signal Modules (HDTM)	-S = Standard Gold on Contact Area, Matte Tin on Tail		-VT = Vertical

HPTS Mates with:
HPTT, BSP

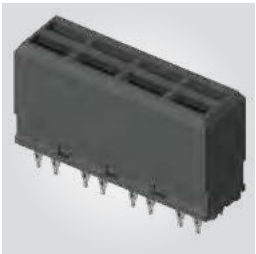
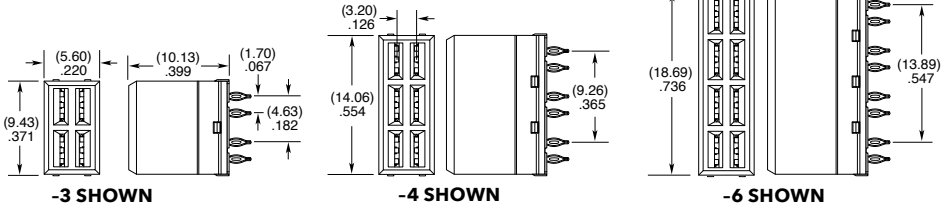
View complete specifications at: samtec.com?HPTS

HPTT	BODY HEIGHT	PLATING	POSITION NO. 1	POSITION NO. 2	POSITION NO. 3	POSITION NO. 4	D	ORIENTATION
= Terminal	Based on Pair Count of Signal Modules (HDTF, BSP)	-S = Standard Gold on Contact Area, Matte Tin on Tail	Contact Wipe Column A & B	Contact Wipe Column A & B	Contact Wipe Column A & B (-4 & -6 Height Only)	Contact Wipe Column A & B (-6 Height Only)		-RA = Right-angle
	-3, -4, -6		-3 = (4.5 mm) 0.18" -6 = (5.5 mm) 0.22"	-3 = (4.5 mm) 0.18" -6 = (5.5 mm) 0.22"	-3 = (4.5 mm) 0.18" -6 = (5.5 mm) 0.22"	-3 = (4.5 mm) 0.18" -6 = (5.5 mm) 0.22"		

HPTT Mates With:
HPTS



Notes:
Some lengths, styles and options are non-standard, non-returnable. XCede® is a registered trademark of Amphenol.

View complete specifications at: samtec.com?HPTT

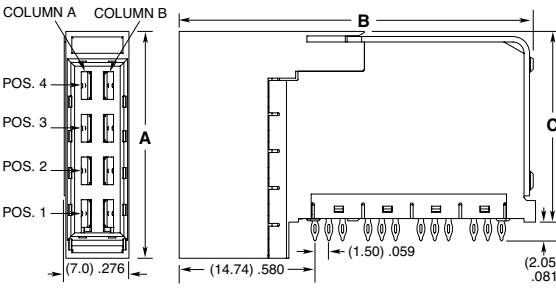

HIGH-SPEED CABLE PANEL ASSEMBLIES

FLYOVER® TECHNOLOGY • UP TO 112 Gbps PAM4 PER CHANNEL • VARIETY OF END OPTIONS

96-99

FLYOVER® QSFP CABLE SYSTEMS
(FQSFP-D8, FQSFP-DD, FQSFP)

FLYOVER®



100-103

NOVARAY® I/O EXTREME
PERFORMANCE SYSTEMS
(NVACP, NVC, NVACE, NVA3E, NVA3P)

NOVARAY® I/O



104-105

EXAMAX® I/O SHIELDED CABLE SYSTEM (EBTC, EBCE)

ExaMAX®





FLYOVER® TECHNOLOGY

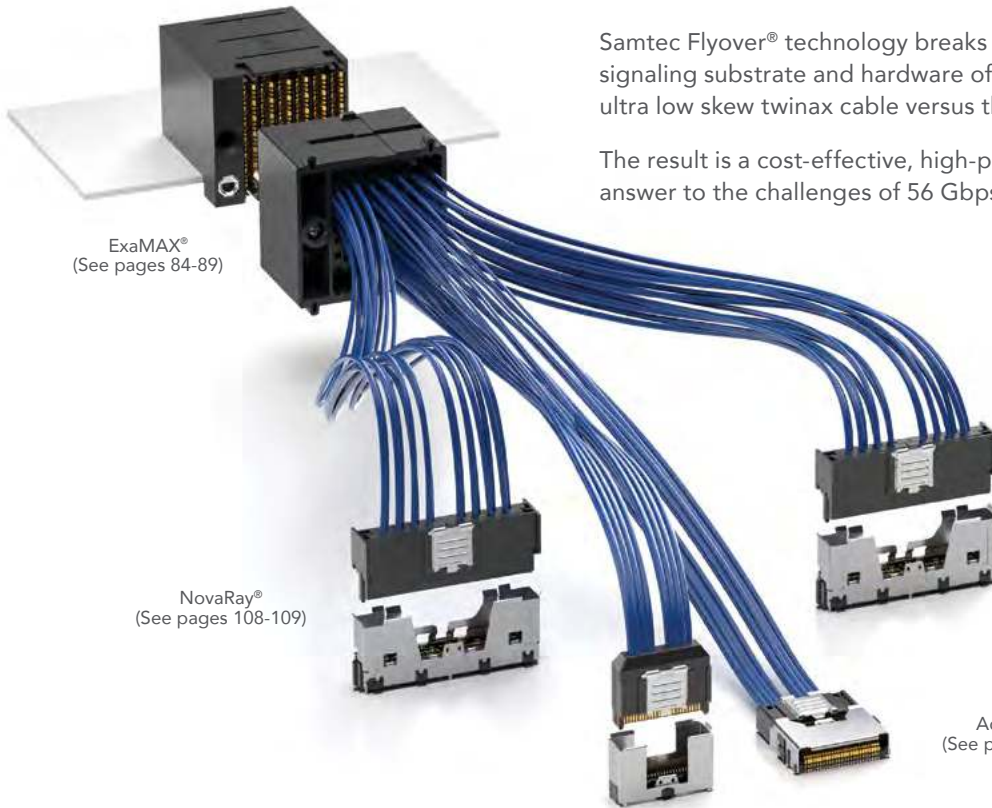

ExaMAX®
(See pages 84-89)

NovaRay®
(See pages 108-109)

AcceleRate®
(See pages 112-113)

Samtec Flyover® technology breaks the constraints of traditional signaling substrate and hardware offerings by routing signals via ultra low skew twinax cable versus through lossy PCB.

The result is a cost-effective, high-performance and heat efficient answer to the challenges of 56 Gbps bandwidths and beyond.

NRZ	PAM4
28 Gbps	56 Gbps
NRZ	PAM4
56 Gbps	112 Gbps

EYE SPEED® TWINAX CABLE TECHNOLOGY

- Ideal for 28 – 112+ Gbps applications
- Tight coupling between signal conductors
- Ultra low skew twinax < 3.5 ps/meter (intra-pair)
- Improved signal integrity and eye pattern opening
- Increased bandwidth and reach
- 40% smaller cross-sectional area (Thinax™)
- In Development: Eye Speed® AIR™ foamed twinax for significantly improved signal integrity and even lower intra-pair skew

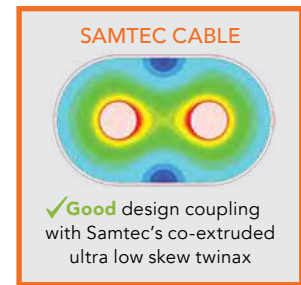
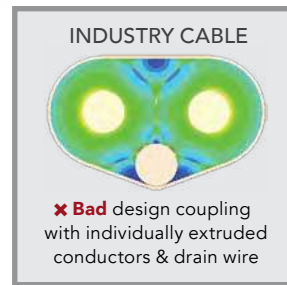

THERMAL IMPROVEMENT

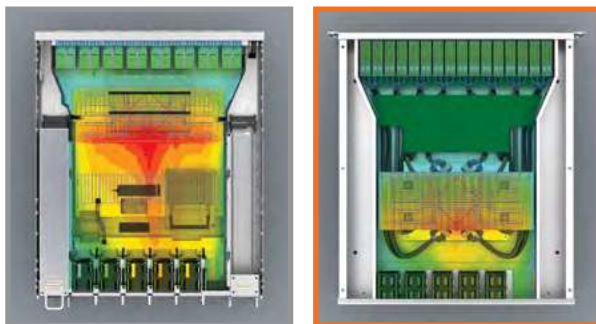

Standard Network Switch vs. Samtec Flyover® Technology

PERFORMANCE & COST ADVANTAGES

- 28 - 56 Gbps NRZ and beyond
- Simplified board layout
- Less expensive PCB materials, fewer PCB layers
- Eliminates expensive re-timers

SUPPORT

Fully integrated technology teams for full system optimization from Silicon-to-Silicon, including Samtec's High-Speed Cable Plants.

CABLE SPECIFICATIONS



ULTRA LOW SKEW TWINAX CABLE

Samtec's proprietary co-extruded Eye Speed® twinax cable technology eliminates the performance limitations and inconsistencies of individually extruded dielectric twinax cabling, improving signal integrity, bandwidth and reach for high-performance system architectures.

- Micro cellular dielectric extrusion
- Critical dimensions measured at every dielectric spool
- Inline laser and CAPAC devices for capacitance monitoring and diameter control
- In-process stats summary sheet for Cpk acceptance

NOMINAL PERFORMANCE SPECIFICATIONS			28 AWG	30 AWG	32 AWG	34 AWG	36 AWG
14 GHz (28G NRZ/ 56G PAM4)	0.25 m	IL (dB)	-1.0	-1.2	-1.5	-1.8	-2.2
	1.00 m		-4.1	-4.7	-5.9	-7.5	-8.9
28 GHz (56G NRZ/ 112G PAM4)	0.25 m		-1.5	-1.8	-2.2	-2.7	-3.2
	1.00 m		-6.1	-7.1	-8.7	-10.9	-13.0
Density/Flexibility			Good	Good	Better	Best	Best

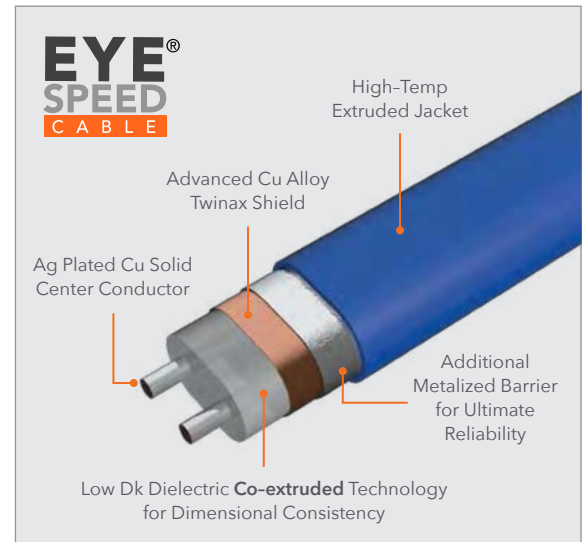

* Eye Speed® Ultra Low Skew Twinax Cable is available in engineered impedance configurations of 85 Ω, 92 Ω and 100 Ω.

THINAX™ ULTRA PERFORMANCE TWINAX CABLE

- 40% smaller cross-sectional area
- 112 Gbps PAM4 performance
- Taped jacket miniaturizes the cable to match smaller, more dense connectors
- Allows for a smaller pitch within a row
- Achieving a smaller row-to-row pitch is dependent upon stack-up and BOR; customizable per application needs



MICRO COAX CABLE

- Foaming introduces air voids for signal to travel faster
- Solid extrusion of foamed dielectric provides a constant and more durable construction
- Lighter weight and smaller size with higher bandwidth capabilities at longer lengths
- 26 - 38 AWG cable available
- Choice of signal conductor, shield and FEP dielectric to meet performance and cost specifications

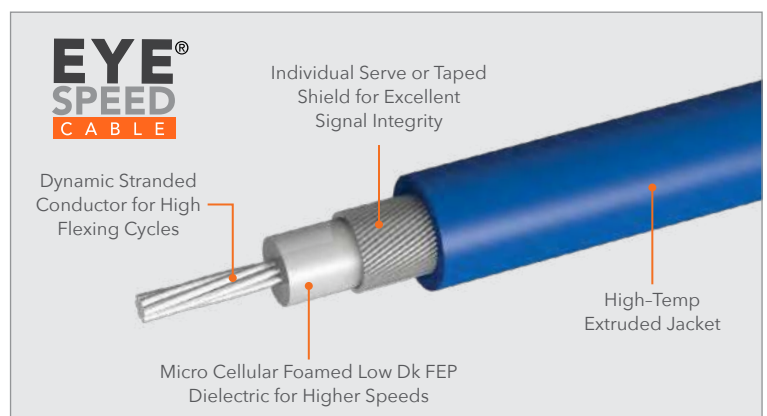

FLYOVER® QSFP CABLE ASSEMBLIES



FEATURES & BENEFITS

QSFP, QSFP-DD and QSFP-D8 systems utilize Samtec Flyover® technology to route data above lossy PCB, simplifying board layout and extending signal reach. The modular design enables optimized systems that improve heat management, increase signal integrity performance, build in scalability for future upgrades and reduce costs by creating a multifunction board.

NRZ	PAM4
56 Gbps	112 Gbps

FLYOVER® QSFP SYSTEM

- 4 Channels (x4 bidirectional, 8 differential pairs)
- Up to 400 Gbps aggregate (112 Gbps PAM4)
- Compatible with all MSA QSFP pluggables
- Multiple heat sink options available for optimal dissipation
- Eye Speed® 30 or 34 AWG twinax cable
- Multiple end 2 options for design flexibility
- Evaluation Kits available (REF-205303-X.XX-XX), visit samtec.com/kits



Localized press-fit control and power contacts eliminate the need for a secondary cable and connector



High-speed contacts directly soldered to Eye Speed® ultra low skew twinax

FLYOVER® QSFP DOUBLE DENSITY

- 8 Channels (x8 bidirectional, 16 differential pairs)
- Up to 400 Gbps aggregate (56 Gbps PAM4)
- Belly-to-belly mating for maximum density
- Backward compatible with QSFP modules
- Multiple heat sink options available for optimal dissipation
- Variety of end 2 options
- Evaluation Kits available (REF-205605-X.XX-XX and REF-203424-X.XX-XX), visit samtec.com/kits

800G FLYOVER® DOUBLE DENSITY

- 8 Channels (x8 bidirectional, 16 differential pairs)
- Up to 800 Gbps aggregate (112 Gbps PAM4)
- Belly-to-belly mating for maximum density
- Backward compatible with QSFP & QSFP-DD modules
- Multiple heat sink options available for optimal dissipation
- Variety of end 2 options

800G FLYOVER® QSFP DOUBLE DENSITY CABLE ASSEMBLY

FQSFP	D8	CABLE TYPE	FOOTPRINT	CABLE LENGTH	END 2 OPTION
-------	----	------------	-----------	--------------	--------------

FQSFP-D8



PRESS-FIT TOOLING
 CAT-PF-FQSFP-DD-01
 For more information, visit www.samtec.com/tooling

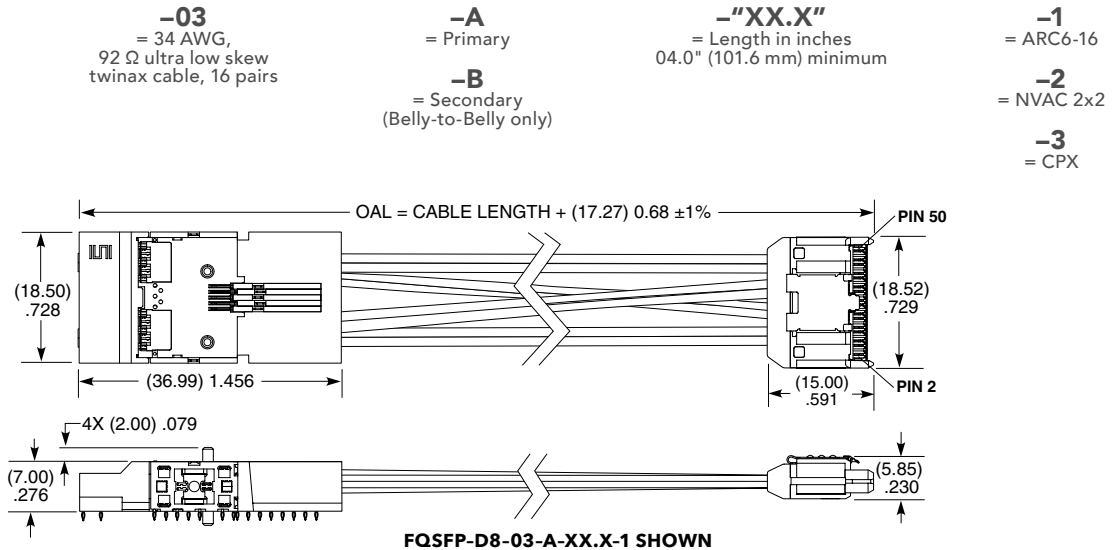

QSFP	D8	STACK	NO. OF PORTS	OPTION	STYLE
------	----	-------	--------------	--------	-------

QSFP-D8



-1
= Single Stack

-1
= One Port

-S
= Spring Fingers

-F
= Flyover

-2
= Two Ports

PRESS-FIT TOOLING
 CAT-PT-FQSFP-03-XX
 For more information, visit www.samtec.com/tooling

NO. OF PORTS	A	B	C
-1	(20.96) .825	(19.87) .782	(19.00) .748
-2	(39.96) 1.573	(38.87) 1.530	(38.00) 1.496

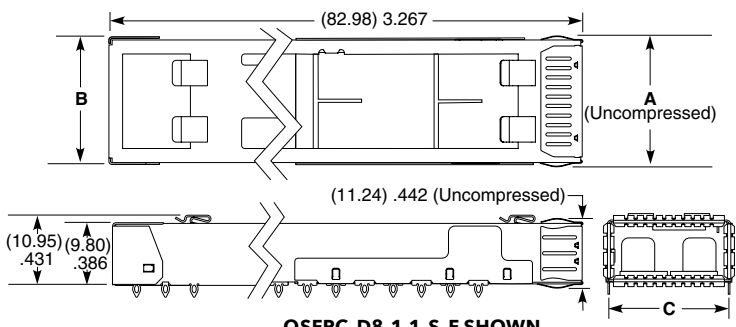

Note:
 Some sizes, styles and options are non-standard, non-returnable.

HS-QSFP	D8	HEAT SINK HEIGHT
---------	----	------------------

HS-QSFP-D8



-1
= (6.20 mm) .244" height

-2
= (12.00 mm) .472" height

HEAT SINK HEIGHT	A
-1	(6.29) .248
-2	(12.00) .472

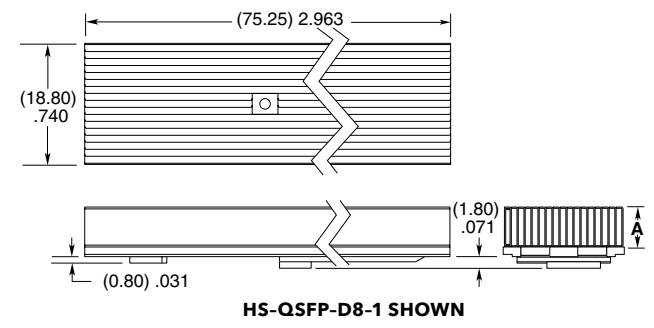

FLYOVER® QSFP DOUBLE DENSITY CABLE ASSEMBLY

FQSFP	DD	LEAD STYLE	FOOTPRINT	CABLE LENGTH	END 2 OPTION
--------------	-----------	-------------------	------------------	---------------------	---------------------

-01
= 20 Low-Speed,
16 Pairs High-Speed

-A
= Primary

-"XX.X"
= Length in inches
04.0" (101.6 mm) minimum

-3
= ARC6-16

FQSFP-DD

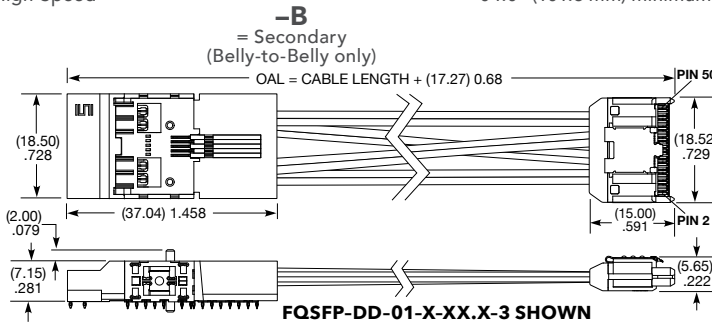

Additional end options
such as NovaRay®
available; contact
HDR@samtec.com

PRESS-FIT TOOLING

CAT-PF-FQSFP-DD-01
For more information, visit
www.samtec.com/tooling

Note:
Some sizes, styles and options are
non-standard, non-returnable.

View complete specifications at: samtec.com?FQSFP-DD

QSFP	DD	STACK	NUMBER OF PORTS	EMI PANEL OPTION	FLYOVER
-------------	-----------	--------------	------------------------	-------------------------	----------------

-1
= Single Stack

-1
= One Port

-S
= Spring Fingers

-F
= Flyover

QSFP-DD

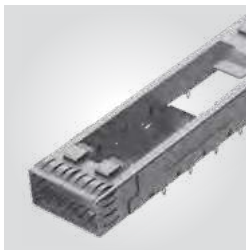

-2
= Two Ports

-3
= Three Ports

NO OF PORTS	A	B	C
-1	(20.62) .812	(19.87) .782	(19.00) .748
-2	(39.62) 1.560	(38.87) 1.530	(38.60) 1.496
-3	(58.62) 2.308	(57.87) 2.278	(57.00) 2.244

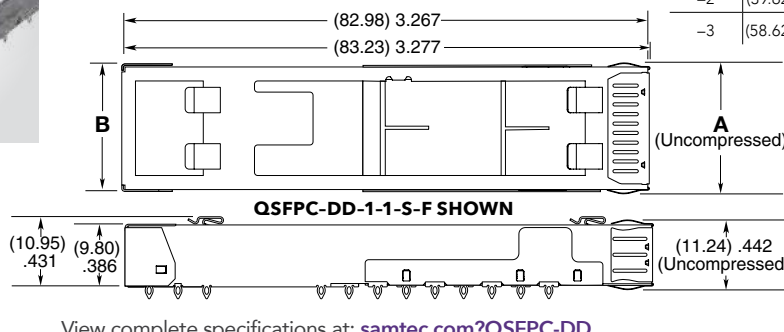

PRESS-FIT TOOLING

CAT-PF-FQSFP-DD-02-01 (1 Port)
CAT-PF-FQSFP-DD-02-02 (2 Port)
CAT-PF-FQSFP-DD-02-03 (3 Port)
For more information, visit
www.samtec.com/tooling

View complete specifications at: samtec.com?QSFP-DD

HS-QSFP	DD	HEAT SINK STYLE	HEAT SINK HEIGHT
----------------	-----------	------------------------	-------------------------

HS-QSFP-DD



-P1
= Pin (Aluminum)

-1
= (4.20 mm) .165" height

-2
= (6.50 mm) .256" height

-3
= (13.50 mm) .531" height

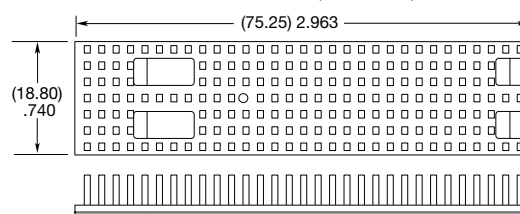

HS-QSFP-DD-P1-2 SHOWN

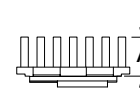

HEAT SINK HEIGHT	A
-1	(4.20) .165
-2	(6.50) .256
-3	(13.50) .531

Note:
Some sizes, styles and options are
non-standard, non-returnable.

View complete specifications at: samtec.com?HS-QSFP-DD

FLYOVER® QSFP CABLE ASSEMBLY

FQSFP	LEAD STYLE	CABLE LENGTH	PLATING	CONTACT TYPE	END OPTION
-------	------------	--------------	---------	--------------	------------

-01
= 10 Low-Speed,
8 Pairs High-Speed

-"XX.X"
= Length in inches
04.0" (101.6 mm)
minimum

-L
= 10 μ" (0.25 μm)
Gold over
50 μ" (1.27 μm)
Ni on contact area,
Matte Tin on tail

-PF
= Press-fit

-3
= ECUE
-4
= ARC6-8

FQSFP

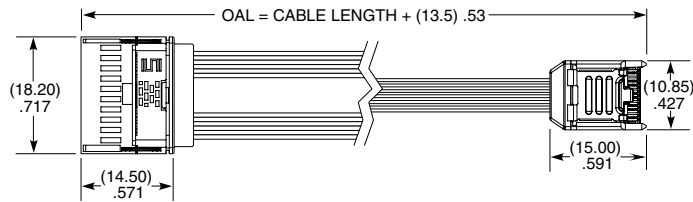

PRESS-FIT TOOLING

CAT-PT-FQSFP-01
For more information, visit
www.samtec.com/tooling

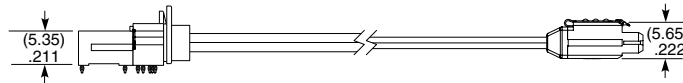

FQSFP-01-XX.X-L-PF-4 SHOWN

QSFCP	CAGE OPTION	NUMBER OF PORTS	EMI PANEL OPTION	OPTION	FLYOVER
-------	-------------	-----------------	------------------	--------	---------

-1
= Single Stack

-1
= One Port

-S
= Spring
Fingers

(Leave blank for no Light Pipe)

(Leave blank for no flyover)

-2
= Two Ports

-LP
= Light Pipe
(1 & 4 ports only)

-F
= Flyover

-4
= Four Ports

-N
= No heat sink closed top
(Not available with -LP)

QSFCP

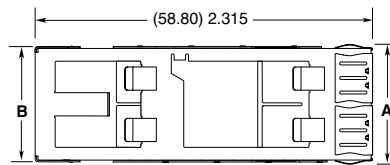
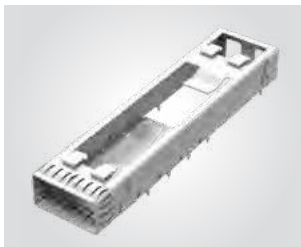

NO. OF PORTS	A	B	C
-1	(20.62) .812	(19.85) .781	(19.00) .748
-2	(39.62) 1.560	(38.85) 1.530	(38.00) 1.496
-4	(77.62) 3.056	(76.85) 3.026	(76.00) 2.992

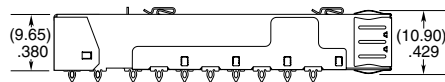

QSFCP-1-1-S-F SHOWN

PRESS-FIT TOOLING

CAT-PT-FQSFP-03-XX
For more information, visit
www.samtec.com/tooling

HEAT SINKS

PART NUMBER	HEAT SINK HEIGHT
HS-QSFP-P1-01	(4.20 mm) .165"
HS-QSFP-P1-02	(6.50 mm) .256"
HS-QSFP-P1-03	(13.50 mm) .531"
HS-QSFP-P1-04	(1.50 mm) .059"

For Light Pipe, add -LP to the end of part number.
View complete specifications at samtec.com?HS-QSFP

LIGHT PIPES

PART NUMBER	NO. OF PORTS
LP-FQSFP-01	1 pipe
LP-FQSFP-02	2 pipes
LP-FQSFP-04	4 pipes

View complete specifications at samtec.com?LP-FQSFP

Notes:
Some sizes, styles and
options are non-standard,
non-returnable.

View complete specifications at: samtec.com?FQSFP & samtec.com?QSFCP

NOVARAY[®] I/O

EXTREME PERFORMANCE PANEL MOUNT I/O ASSEMBLIES

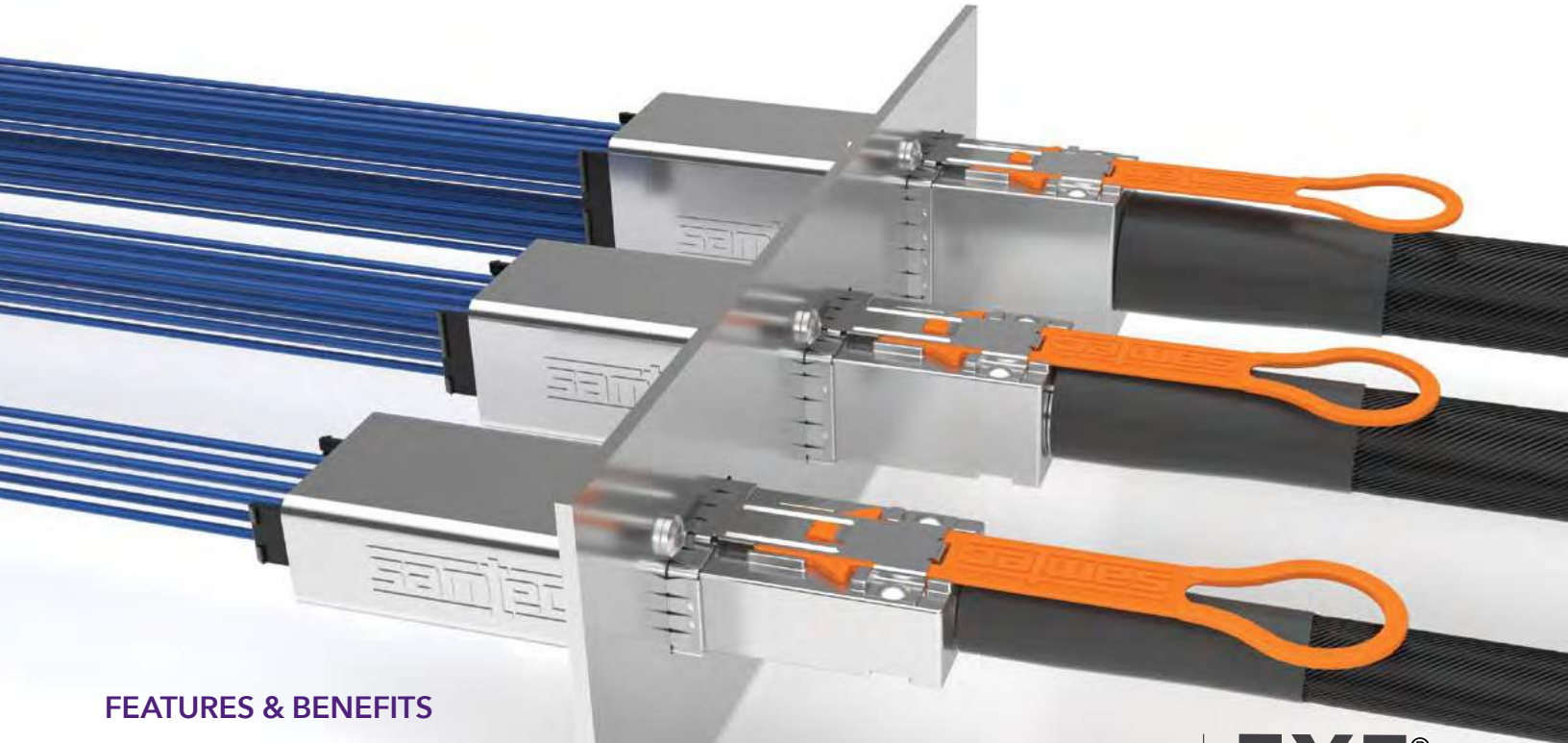

FEATURES & BENEFITS

- 16 & 32 differential pair configurations
– Accommodates x4 or x8 plus sidebands
- Cable-to-Cable bulkhead panel connection using Flyover[®] Cable Technology
- External Cable: 28 or 34 AWG twinax
- Internal Cable: 34 AWG twinax
- Single-Ended coax options also available
- Full external EMI shielding
- Multiple end 2 high-speed connector options on internal cable
- Available in a rugged 38999 shell for salt fog resistance to 48 hours and IP67 rated for dust and water applications

NOVARAY[®] I/O

EYE[®]
SPEED
CABLE

VARIOUS END 2 OPTIONS AVAILABLE

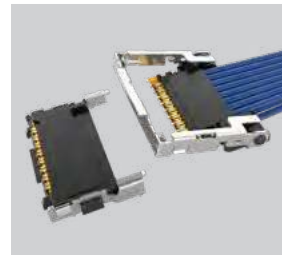

Si-Fly[™]



NovaRay[®]

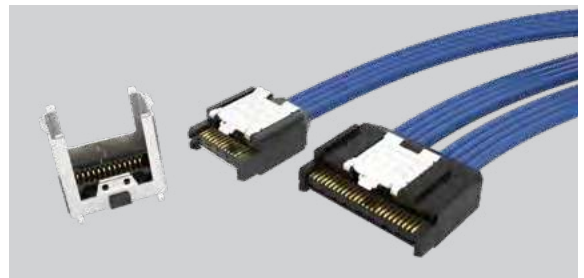

AcceleRate[®]

PAM 4

112
G b p s

TARGETED CONFIGURATIONS	AGGREGATE DATA RATE
8 Pair (In Development)	896 Gbps
16 Pair	1792 Gbps
32 Pair	3584 Gbps
x4 (8 Pair + PCIe [®] Sidebands)	512 Gbps
x8 (16 Pair + PCIe [®] Sidebands)	1024 Gbps

PCI EXPRESS[®]
GEN 6 COMPATIBLE

EXTREME PERFORMANCE PANEL MOUNT CABLE

NVACP	SIGNAL TYPE	CABLE STYLE	ROWS	CABLE LENGTH	END 2	PIN OUT	SPEED
	-DP = Differential (twinax pairs only)	-1 = 34 AWG 100 Ω ultra low skew twinax	-4 = 4 rows	-XX.X = Length in inches 06.0" (152.4 mm) minimum	-A = 1 ARC6	-1 = Pin A01 to Pin A01	(Differential twinax pairs only)
	-SE = Single ended (coax signals only)		-8 = 8 rows		-B = 1 NVAC	-4 = Pin A01 to Pin AN (N equals last position)	-1 = 56G PAM4 -2 = 112G PAM4

NVACP
Cable Mates:
NVACE
Panel Cage:
NVC

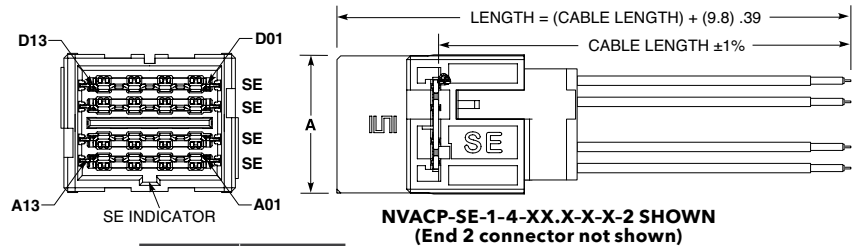

ROW	A
-4	(12.95) .510
-8	(20.95) .825

Notes:
Cable lengths longer than 40.00" (1 meter) are not supported with S.I. test data.
Some sizes, styles and options are non-standard, non-returnable.

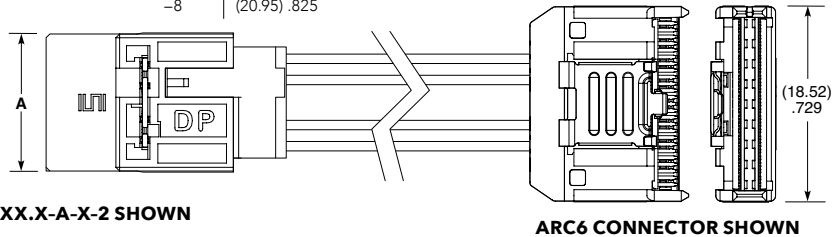
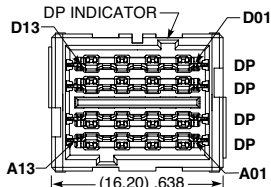

DIE CAST PANEL CAGE

View complete specifications at: samtec.com?NVACP

NVC	NO. OF PORTS	ROWS	PACKAGING
-----	--------------	------	-----------

NVC
Use with:
NVACP, NVACE



-1
= 1 Port

-2
= 2 Ports (8 row only)

-4
= 4 Ports (8 row only)

-04
= 4 rows

-08
= 8 rows

-TY
= Trays

ROW	A	B	C	D
-04	(16.55) .652	(23.35) .919	(15.36) .605	(19.56) .770
-08	(24.55) .967	(31.35) 1.234	(23.36) .920	(27.56) 1.085

Note:
Some sizes, styles and options are non-standard, non-returnable.

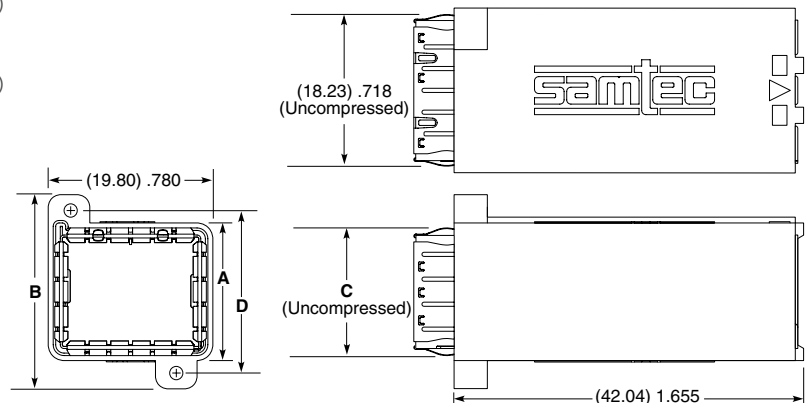

View complete specifications at: samtec.com?NVC

EXTREME PERFORMANCE I/O CABLE

NVACE	SIGNAL TYPE	CABLE TYPE	ROWS	CABLE LENGTH	END 2	PIN OUT	SPEED
	-DP = Differential (twinax pairs only)	-1 = 34 AWG, 100 Ω ultra low skew twinax	-4 = 4 rows	-X.X = Length in meters 0.5 meters (19.69") minimum	-A = NVACE	-1 = Pin A01 to Pin A01	(Differential twinax pairs only)
	-SE = Single ended (coax signals only)	-5 = 28 AWG, 100 Ω ultra low skew twinax	-8 = 8 rows			-4 = Pin A01 to Pin N	-1 = 56G PAM4
		-6 = 34 AWG, 50 Ω coax (-SE only)					-2 = 112G PAM4

NVACE

Cable Mates:
NVACP
Panel Cage:
NVC

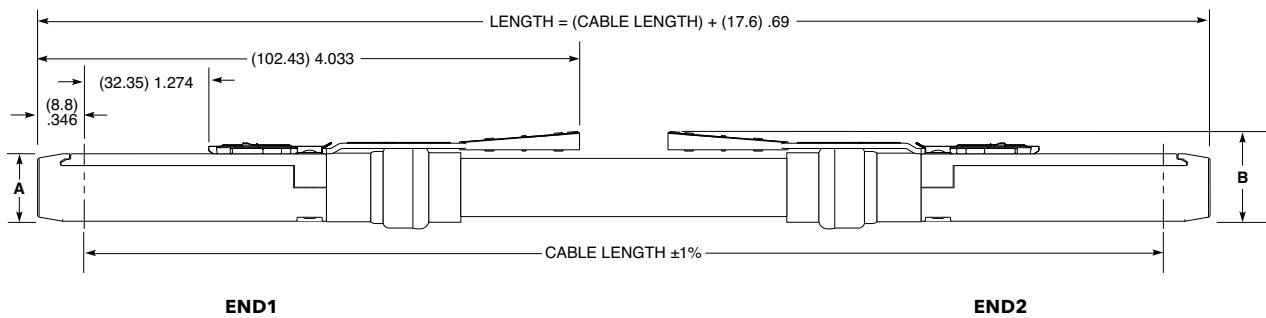

NVACE-XX-X-4-X-X-A-X-2 SHOWN

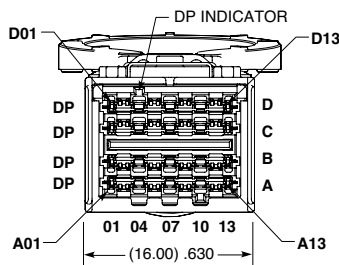

-DP SHOWN

ROW	A	B
-4	(12.75) .502	(17.00) .669
-8	(20.75) .817	(25.00) .984

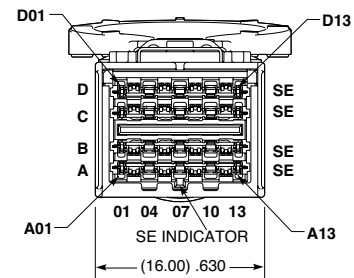

-SE SHOWN

Notes:
Cable lengths longer than 3 meters (118") are not supported with S.I. test data.

Some sizes, styles and options are non-standard, non-returnable.

View complete specifications at: samtec.com?NVACE

RUGGED 38999 I/O CABLE

NVA3E	SIGNAL TYPE	CABLE TYPE	SHELL SIZE	CABLE LENGTH	END 2	PIN OUT	SPEED	FINISH	IP SEALING
	-DP = Differential (twinax pairs only)	-1 = 34 AWG, 100 Ω ultra low skew twinax	-19 = 4 rows	(Standard lengths in meters) -00.5 = (0.5 m) 19.69" Cable -01.0 = (1.0 m) 39.37" Cable -02.0 = (2.0 m) 78.74" Cable -03.0 = (3.0 m) 118.11" Cable	-A = NVA3E	-1 = Pin A01 to Pin A01 -4 = Pin A01 to Pin N	-1 = 56G PAM4 -2 = 112G PAM4	-Z = Black Zinc Nickel	(Leave blank for no sealed) -S = Sealed

NVA3E
Cable Mate:
NVA3P



Notes:
Cable lengths longer than 3 meter (118.00") are not supported with S.I. test data.

Some sizes, styles and options are non-standard, non-returnable.

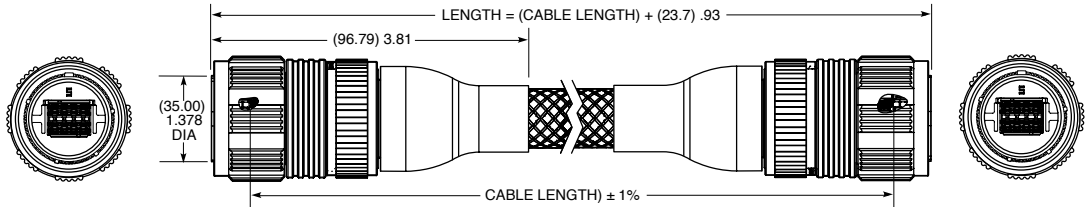

NVA3E-DP-X-19-XX.X-A-X-1-Z-S SHOWN

View complete specifications at: samtec.com?NVA3E

RUGGED 38999 PANEL MOUNT CABLE

NVA3P	SIGNAL TYPE	CABLE TYPE	SHELL SIZE	CABLE LENGTH	END 2	PIN OUT	SPEED	FINISH	IP SEALING
	-DP = Differential (twinax pairs only)	-1 = 34 AWG, 100 Ω ultra low skew twinax	-19 = 4 rows	(Standard lengths in inches) -06.0 = (152.4 mm) 6.0" Cable -10.0 = (254.0 mm) 10.0" Cable -12.0 = (304.8 mm) 12.0" Cable -20.0 = (508.0 mm) 20.0" Cable	-A = ARC6 -B = NVAC	-1 = Pin A01 to Pin A01 -4 = Pin A01 to Pin AN (N equals last position)	-1 = 56G PAM4 -2 = 112G PAM4	-Z = Black Zinc Nickel	(Leave blank for no sealed) -S = Sealed

NVA3P
Cable Mate:
NVA3E



Notes:
Cable lengths longer than 1 meter (40.00") are not supported with S.I. test data.

Some sizes, styles and options are non-standard, non-returnable.

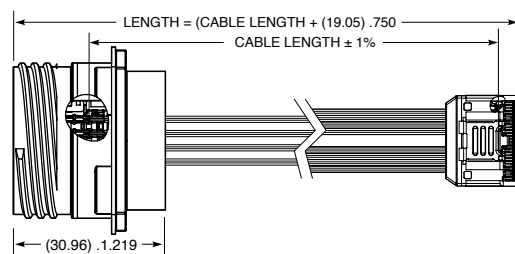
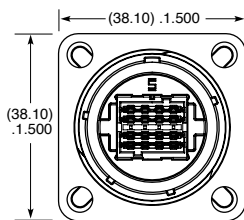

NVA3P-DP-1-19-XX.X-A-X-1-Z-S SHOWN

View complete specifications at: samtec.com?NVA3P

ExaMAX[®]

SHIELDED, HIGH-DENSITY I/O CABLE SYSTEM

(2.00 mm) .0787" PITCH

PAM4

56
Gbps

FEATURES & BENEFITS

- Fully shielded external cable and cage for EMI protection
- Rugged pull latch for mating/unmating
- Single port cage designed for use with ExaMAX[®] right-angle board connector (EBTM-RA)
- 30 and 34 AWG ultra low skew twinax
- 24 to 72 pairs (4 and 6 pairs; 6, 8, 10 and 12 columns)
- In Development: Cable-to-cable bulkhead panel connection for increased performance to 112 Gbps PAM4



Cable to right-angle panel mount

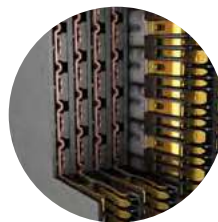

Staggered Differential Pair Design

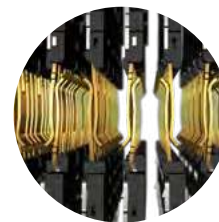

Two Reliable Points of Contact at All Times

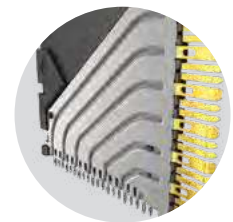

Wafer Design Reduces Crosstalk

KEY SPECIFICATIONS (EBCE/EBTC)

CABLE	INSULATOR MATERIAL	CONTACT MATERIAL	PLATING	OPERATING TEMP RANGE	CURRENT RATING	VOLTAGE RATING
30 & 34 AWG ultra low skew twinax	LCP	Copper Alloy	Au over 50 μ" (1.27 μm) Ni	Testing Now!	Testing Now!	Testing Now!

(2.00 mm) .0787" PITCH • SHIELDED PANEL MOUNT CABLE

EBCE	GAUGE/ SIGNAL MAP	PAIRS PER COLUMN	COLUMNS	END 1 PIN	CABLE LENGTH	END 2 PIN
	-1 = 34 AWG 100 Ω, Tx to Rx Signal Map	-4 = 4 Pairs	-06, -08, -10, -12 (6 pair only)	-1 = Standard	-"XX" = Length in Inches 12" (304.8 mm) minimum	-1 = Standard
	-2 = 30 AWG 100 Ω, Tx to Rx Signal Map	-6 = 6 Pairs				
	-3 = 34 AWG 100 Ω, 1:1 Signal Map					
	-4 = 30 AWG 100 Ω, 1:1 Signal Map					

NO. OF COLUMNS	B
-06	(18.40) .724
-08	(22.40) .882
-10	(26.40) 1.039
-12	(30.40) 1.197

EBCE
Mates With:
EBTM-RA/EBTC

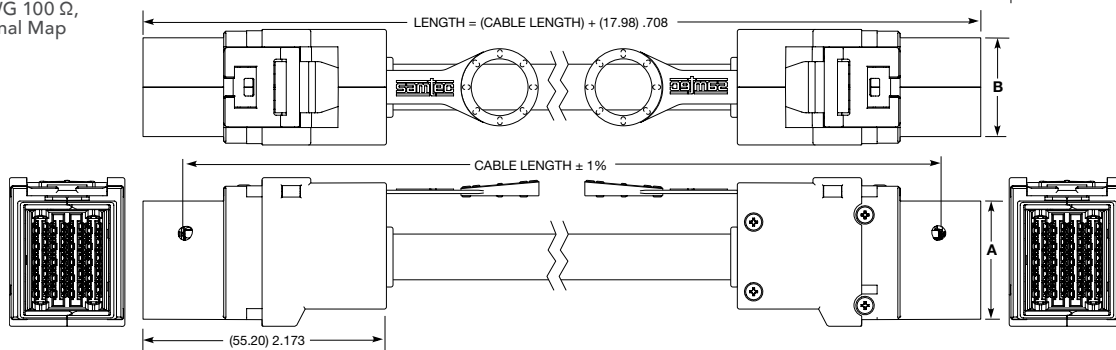

Notes:
Cable lengths longer than 40.00" (1 meter)
are not supported with S.I. test data.

Some sizes, styles and options
are non-standard, non-returnable.

PAIRS	A
-4	(26.80) 1.055
-6	(34.00) 1.339

DIE CAST PANEL CAGE

View complete specifications at: samtec.com?EBCE

EBTC	PAIRS PER COLUMN	COLUMNS	PORT SIZE
	-4 = 4 Pairs -6 = 6 Pairs	-06, -08, -10, -12 (6 pair only)	-1

EBTC
Use With:
EBTM-RA, EBCE

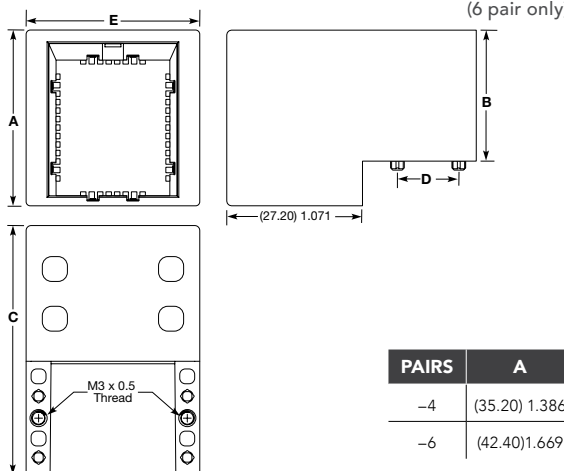

NO. OF COLUMNS	E
-06	(30.80) 1.213
-08	(34.80) 1.370
-10	(38.80) 1.528
-12	(42.80) 1.685

PAIRS	A	B	C	D
-4	(35.20) 1.386	(26.25) 1.033	(50.00) 1.969	(12.30) .484
-6	(42.40) 1.669	(33.45) 1.317	(57.20) 2.252	(19.50) .768

Note:
Some sizes, styles and
options are non-standard,
non-returnable.

View complete specifications at: samtec.com?EBTC



IN DEVELOPMENT: FLYOVER® PANEL ASSEMBLIES

112 GBPS PAM4 FLYOVER® SFP & OSFP CABLE SYSTEMS

Next gen panel assemblies utilize Samtec's Flyover® technology to route critical high-speed signals through Eye Speed® ultra low skew twinax and Thinax™ ultra performance twinax cable, simplifying board layout and extending signal reach. Contact HDR@samtec.com for more information.



FLYOVER® SFP112

- 112 Gbps per channel performance
- Ideal for next gen higher speed applications including DataCom, Medical, Industrial and Instrumentation
- Optimized cage and heatsink design for excellent thermal and signal integrity performance
- Accepts all MSA compliant SFP pluggable modules
- Press-fit tails
- Light pipes available for front panel indication of operational status
- Single and multi-port cage options
- Multiple end 2 ASIC adjacent connectors for maximum design flexibility: AcceleRate®, Si-Fly™, NovaRay®, AcceleRate® HP, FireFly™, Generate™ (GC6), AcceleRate® Mini

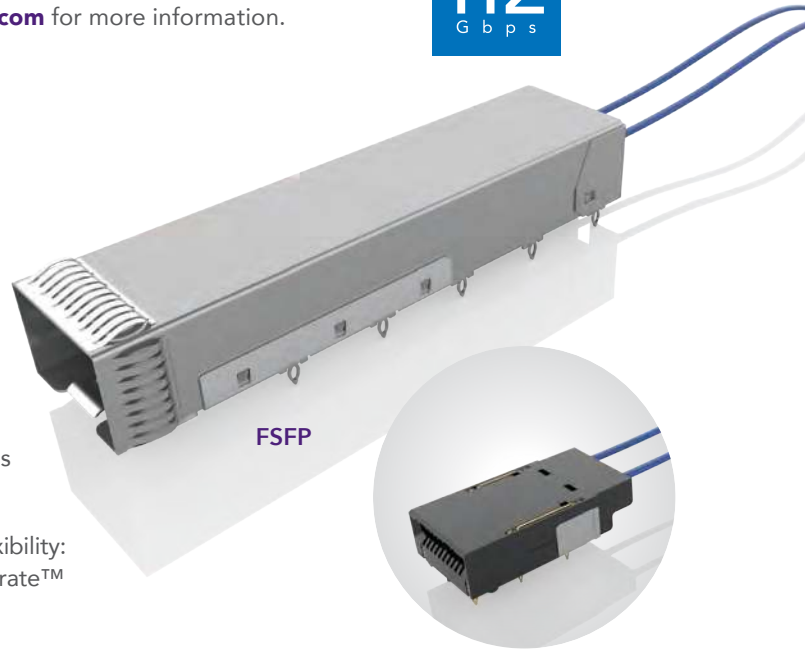

FLYOVER® OSFP 112 Gbps PAM4

- 112 Gbps per channel performance
- 8 channels (x8 bidirectional, 16 differential pairs)
- Optimized cage and heatsink design for excellent thermal and signal integrity performance
- Direct attach contacts soldered to Thinax™ ultra performance twinax cable eliminates long signal traces in transition board, improving signal integrity
- Sideband signaling via press-fit contacts for increased airflow
- Multiple end 2 options: AcceleRate®, Si-Fly™, NovaRay®, AcceleRate® HP, FireFly™, Generate™ (GC6), FireFly™, AcceleRate® Mini
- 224 Gbps solution in development (FOSFP2)

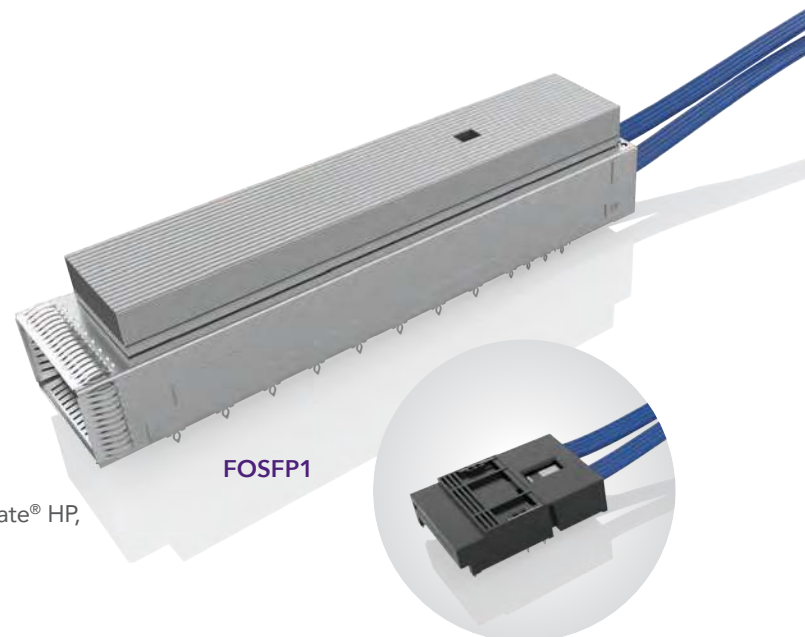

HIGH-SPEED CABLE MID-BOARD SYSTEMS

FLYOVER® TECHNOLOGY • UP TO 112 Gbps PAM4 PER CHANNEL • VARIETY OF END OPTIONS

108-109

NOVARAY® EXTREME DENSITY & PERFORMANCE SYSTEM (NVAC, NVAM-CT)

NOVARAY®



110-111

ACCELERATE® HP HIGH-PERFORMANCE CABLE SYSTEM (ARP6, APF6-L)

ACCELERATE® HP

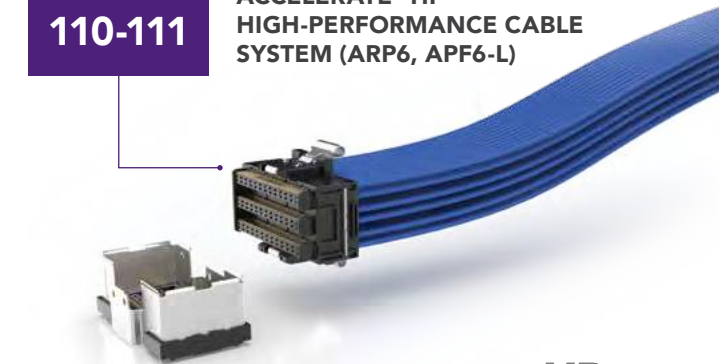

112-113

ACCELERATE® SLIM CABLE SYSTEM (ARC6, ARF6)

ACCELERATE®

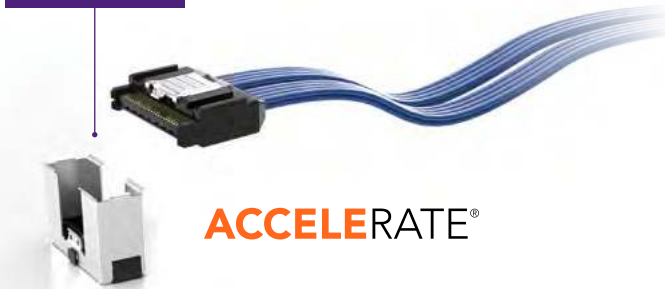

114-115

ACCELERATE® MINI EXTREME PERFORMANCE MINI FORM FACTOR (ARM6, AMF6)

ACCELERATE® mini



116-117

SI-FLY™ LOW PROFILE, HIGH-DENSITY CABLE SYSTEM (CPC, CPI)

SI-FLY™ LP

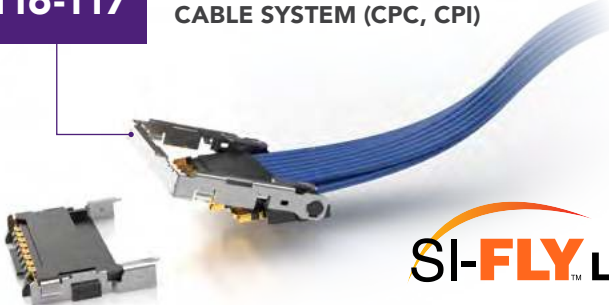

118

GENERATE™ HIGH-SPEED EDGE CARD SYSTEM (GC6)

GENERATE™

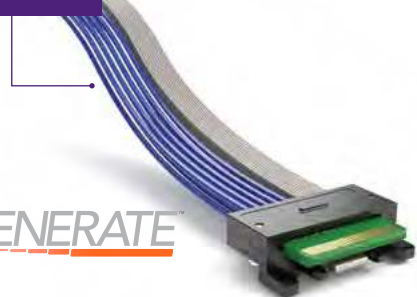

NOVARAY[®]

EXTREME HIGH-SPEED, HIGH-DENSITY CABLE



NRZ	PAM4
56 Gbps	112 Gbps

FEATURES & BENEFITS

- 112 Gbps PAM4 per channel
- 4.0 Tbps aggregate data rate - 9 IEEE 400G channels
- Innovative, fully shielded differential pair design enables extremely low crosstalk (beyond 40 GHz) and tight impedance control
- 48 differential pairs per square inch
- Industry leading aggregate data rate density - 2x the data rate in 60% of the space
- 8 to 32 differential pairs; up to 72+ pairs in development
- Panel I/O solution available with extended EMI shielding (NVACE/NVACP) or rugged 38999 shell (NVA3E/NVA3P); see page 100-103
- Eye Speed[®] Thinax[™] ultra performance twinax cable version in development

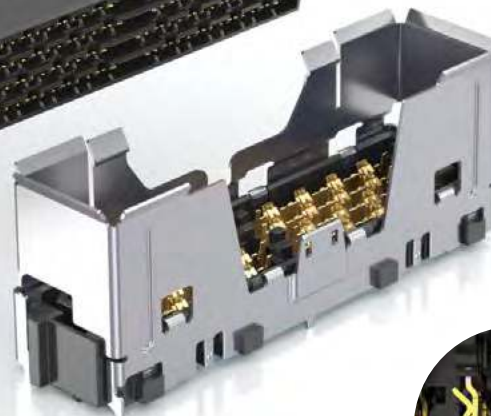

Two reliable points of contact guaranteed

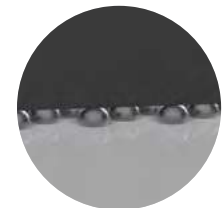

BGA attach for density and optimized trace breakout region

Aggregate Data Rate (NRZ)						
448 Gbps	672 Gbps	896 Gbps	1344 Gbps	1792 Gbps	4032 Gbps*	
1 Bank			2 Bank			3 Bank*
2 Row	3 Row	4 Row	2 Row	3 Row	4 Row	6 Row*
8 Pairs	12 Pairs	16 Pairs	24 Pairs	32 Pairs	72 Pairs*	
*In development						

KEY SPECIFICATIONS (NVAC/NVAM-CT)

CABLE	SIGNAL ROUTING	INSULATOR MATERIAL	CONTACT MATERIAL	PLATING	OPERATING TEMP RANGE
34 AWG ultra low skew twinax	92 Ω & 100 Ω	LCP	Copper Alloy	Au over 50 μ" (1.27 μm) Ni	-40 °C to +125 °C

EXTREME PERFORMANCE & DENSITY SYSTEM

NVAC	STYLE	CABLE STYLE	NO. OF ROWS	NO. OF BANKS	CABLE LENGTH	01	PIN OUT	OPTION
------	-------	-------------	-------------	--------------	--------------	----	---------	--------

-DP
= 4 pairs per wafer

-1
= 34 AWG, 100 Ω ultra low skew twinax

-3
= 34 AWG, 92 Ω ultra low skew twinax

-02
= 2 Rows

-03
= 3 Rows

-04
= 4 Rows

-1
= 1 Bank

-2
= 2 Banks

-“XX.X”
= Length in inches (152.4 mm) 06.0” minimum

-1
= Pin A01 to Pin AN (N equals last position)

-L
= Latch

NVAC
Board Mates:
NVAM-CT



NO. OF BANKS	N	B
-1	16	(20.25) .797
-2	32	(36.25) 1.427

ROWS	A
-02	(4.40) .173
-03	(6.20) .244
-04	(8.00) .315

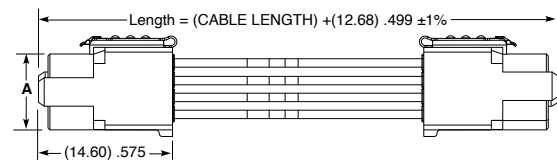
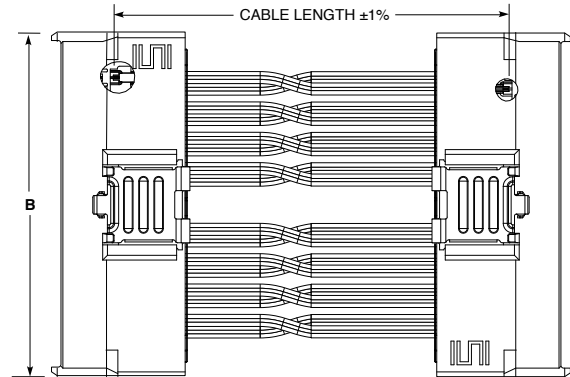

Notes:
Cable lengths longer than 40.00" (1 meter) are not supported with S.I. test data.

View complete specifications at: samtec.com?NVAC

NVAM	STYLE	NO. OF ROWS	NO. OF BANKS	02.0	PLATING OPTIONS	SOLDER TYPE	CT	“X”R
------	-------	-------------	--------------	------	-----------------	-------------	----	------

-DP
= 4 pairs per wafer

-02
= 2 Rows

-03
= 3 Rows

-04
= 4 Rows

-1
= 1 Bank

-2
= 2 Banks

-S
= 30 μ" (0.76 μm) Gold on contact area, Matte Tin on solder tail

-2
= Lead-Free Solder Charge

-TR
= Tape & Reel

-FR
= Full Reel Tape & Reel (must order max. quantity per reel; contact Samtec for quantity breaks)

NVAM-CT
Board Mates:
NVAC

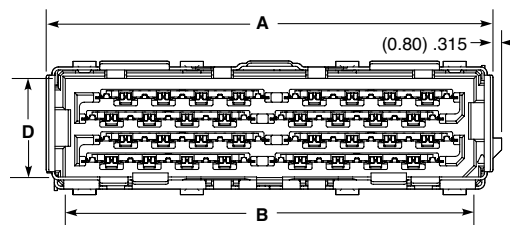

NO. OF BANKS	A	B	C
-1	(21.89) .862	(18.65) .734	(20.25) .797
-2	(37.89) 1.492	(34.65) 1.364	(36.25) 1.427

NO. OF ROWS	D	E	F
-02	(4.80) .189	(5.26) .207	(7.70) .303
-03	(6.60) .260	(7.06) .278	(9.50) .374
-04	(8.40) .331	(8.86) .348	(11.30) .445

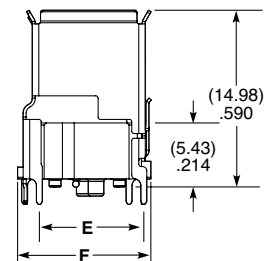
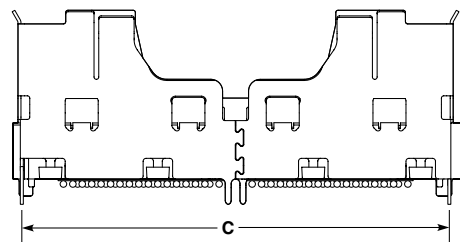

Note:
Some sizes, styles and options are non-standard, non-returnable.

View complete specifications at: samtec.com?NVAM-CT

ACCELERATE[®]HP

EXTREME DENSITY CABLE SYSTEM

(0.635 mm) .025" PITCH

PAM4

112
G b p s

FEATURES & BENEFITS

- Industry's highest density 112G PAM4 cable system
- BGA solder ball attach for simplified board processing
- 0.635 mm contact pitch; 2.20 x 2.40 mm row-to-row pitch
- 4 to 6 rows (8 rows in development); 8 or 12 pairs per row
- Up to 96 twinax cables in development
- Single-ended micro coax configuration
 - 34 AWG ThinSE™ coax
 - 12 or 18 coax per row
 - Dedicated G-S-G-S-G layout for reduced crosstalk
- Right-angle mating connector in development
- 112 Gbps PAM4 Gen 2 on-package system with up to 144 differential pairs and Eye Speed® Thinax™ ultra performance twinax cable (ART6/ATF6); contact HDR@samtec.com for information



Locking for maximum density
(removal tool required)



Squeeze latching for quick
disconnect

KEY SPECIFICATIONS (ARP6/ARF6-L)

PITCH	CABLE	SIGNAL ROUTING	INSULATOR MATERIAL	CONTACT MATERIAL	PLATING	OPERATING TEMP RANGE
(0.635 mm) .025"	34 AWG ultra low skew twinax	92 Ω Differential	Black LCP	Copper Alloy	Au or Sn over 50 μ" (1.27 μm) Ni	-40 °C to +125 °C

(0.635 mm) .025" • HIGH-DENSITY/PERFORMANCE CABLE

ARP6	STYLE	NO. OF POSITIONS	NO. OF ROWS	CABLE LENGTH	END 2 ORIENTATION	END 1 OPTION	END 2 OPTION
	-DP = 92 Ω Ultra low skew twinax cable -SE = 50 Ω ThinSE™ coax cable -DS = Mixed -DP & -SE	Specify NO. OF POSITIONS from chart	-04 = Four Rows -06 = Six Rows	"XX.X" = Length in Inches 05.0" (127 mm) minimum	-T = Top -B = Bottom	-L = Squeeze Latch -T = Locking Tool	-L = Squeeze Latch -T = Locking Tool

ARP6 Board Mates:
APF6-L

ARP6-DP-037-06-XX.X-B-L-L SHOWN

NO. OF POSITIONS PER ROW	A	NO. OF ROWS	B	C
-025	(20.34) .801	-04	(12.54) .494	(18.58) .731
-037	(27.96) 1.101	-06	(17.14) .675	(23.39) .921

STYLE	NO. OF POSITIONS PER ROW	PINOUT ARRANGEMENT
-DP	-025	8 Differential Pairs Per Row
-DP	-037	12 Differential Pairs Per Row
-SE	-025	12 Single-ended Signals Per Row
-SE	-037	18 Single-ended Signals Per Row
-DS	-025	2 Rows of 12 SE, Remaining Rows 8 DP Each
-DS	-037	2 Rows of 18 SE, Remaining Rows 12 DP Each

View complete specifications at: samtec.com?ARP6

APF6	NO. OF POSITIONS	LEAD STYLE	PLATING	ROW	SOLDER TYPE	OPTION	"X"R
	-025, -037 (Per Row)	-03.5 = (3.5 mm) .138"	-L = 10 μ" (0.25 μm) Gold on contact area, Matte Tin on tail -S = 30 μ" (0.76 μm) Gold on contact area, Matte Tin on tail	-04 = Four Rows -06 = Six Rows	-2 = Lead-Free Solder Balls	-L = Squeeze Latch -T = Locking Tool	-TR = Tape & Reel -FR = Full Reel Tape & Reel (must order maximum quantity per reel; contact Samtec for quantity breaks)

APF6-L/ APF6-T Cable Mates:
ARP6

APF6-025-03.5-X-04-2-L SHOWN

NO. OF POSITIONS PER ROW	A	C
-025	(22.39) .881	(17.59) .693
-037	(30.01) 1.181	(25.21) .993

NO. OF ROWS	B	D
-04	(13.50) .531	(9.90) .390
-06	(18.10) .713	(14.50) .571

Note:
Some sizes, styles and options are non-standard, non-returnable.

View complete specifications at: samtec.com?APF6-L & samtec.com?APF6-T

ACCELERATE®

SLIM, DIRECT ATTACH CABLE ASSEMBLIES

(0.635 mm) .025" PITCH

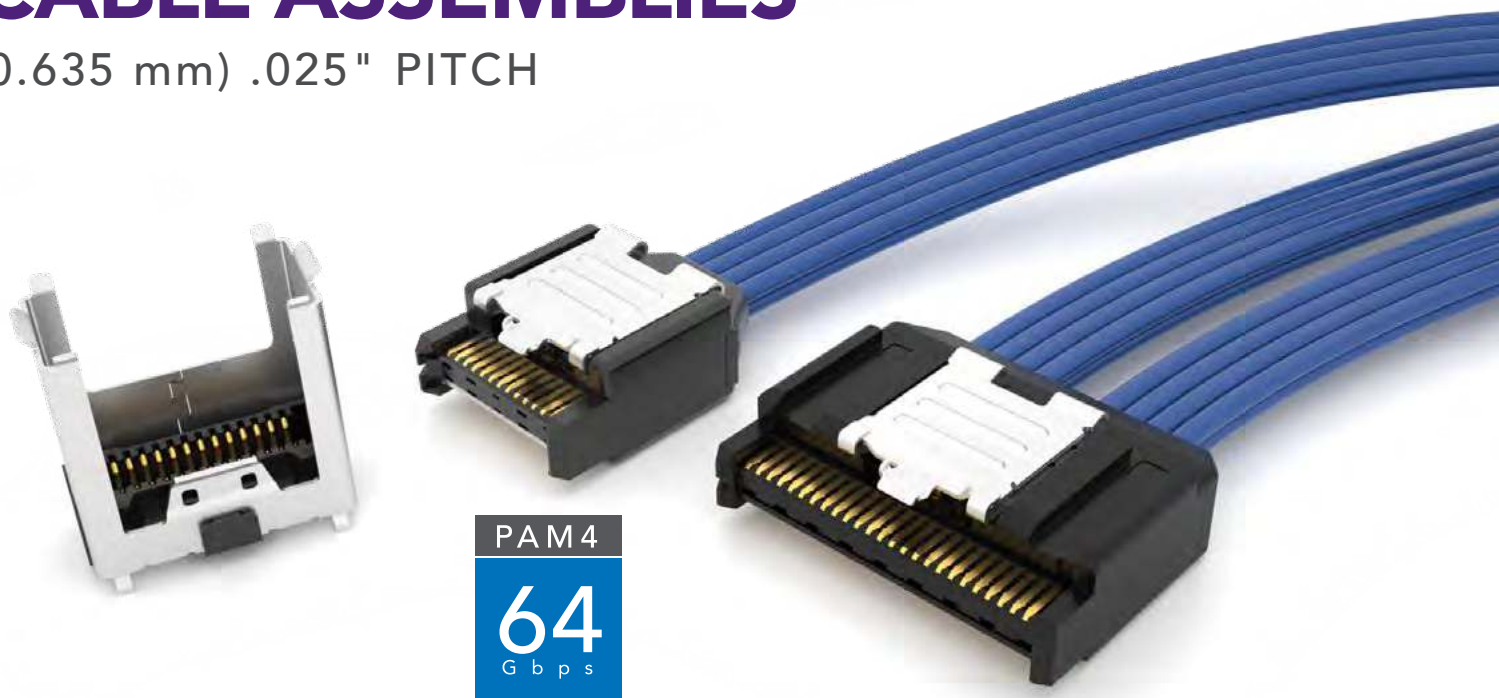

FEATURES & BENEFITS

- Slimmest cable assembly in the industry - 7.6 mm width
- High-density 2-row design
- 8, 16 and 24 differential pair configurations
- 34 AWG, 100 Ω Eye Speed® ultra low skew twinax cable
- Multiple wiring options including reverse polarity
- Mating board level socket (ARF6 Series) features standard rugged weld tabs for increased stability on the PCB
- Rugged metal latching and shielding
- Supports 64 Gbps PAM4 (32 Gbps NRZ) applications
- PCIe® 6.0 capable
- Utilizes Samtec's Flyover® Technology to simplify board layout and extend signal reach

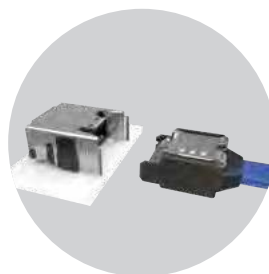

Right-angle available.
Visit [samtec.com?ARF6-RA](https://www.samtec.com?ARF6-RA)
for specifications.



Contacts directly
soldered to the twinax for
improved signal integrity

KEY SPECIFICATIONS (ARC6/ARF6)

PITCH	CABLE	SIGNAL ROUTING	INSULATOR MATERIAL	CONTACT MATERIAL	PLATING	OPERATING TEMP RANGE
(0.635 mm) .025"	34 AWG Eye Speed® ultra low skew twinax	100 Ω Differential	Black LCP	Copper Alloy	Au over 50 μ" (1.27 μm) Ni	-40 °C to +125 °C

(0.635 mm) .025" • SLIM CABLE & SOCKET

ARC6	NO OF PAIRS	CABLE LENGTH	END 1	END 2	WIRING OPTION	CABLE TYPE
------	-------------	--------------	-------	-------	---------------	------------

-08
-16
-24

-“XX.X”
= Length in Inches
03.0" (76.2 mm)
minimum

-LU
= Latch Up

-LU
= Latch Up
-LD
= Latch Down

-2
= Pin 1 to Pin 2
(End 2 -LD option only)

-3
= Pin 1 to Pin N-1
(End 2 -LU option only)

-2R
= Pin 1 to Pin 2
Reversed Polarity
(End 2 -LD option only)
06.0" (152.4 mm) min.
cable length

-3R
= Pin 1 to Pin N-1
Reversed Polarity
(End 2 -LU option only)
06.0" (152.4 mm) min.
cable length

-1
= 34 AWG 100 Ω
Eye Speed®
Ultra low skew
twinax

ARC6
Board Mates:
ARF6

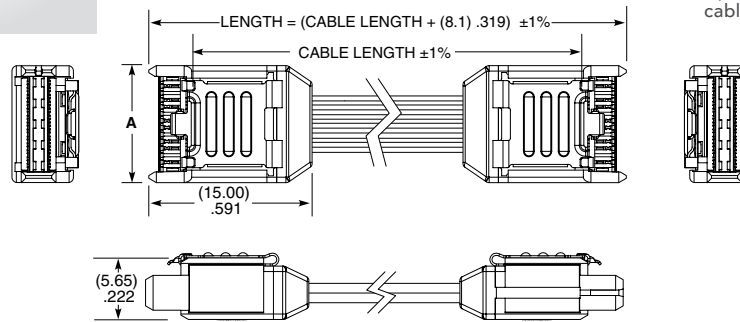

ARC6-08-XX.X-LU-LU-3-X SHOWN

NO. OF PAIRS	A	N	N-1
-08	(10.90) .429	26	25
-16	(18.52) .729	50	49
-24	(26.14) 1.029	74	73

Notes:
Cable lengths longer than 40.00" (1 meter) are not supported with S.I. test data.

View complete specifications at: samtec.com?ARC6

ARF6	NO. OF PAIRS	PLATING	ROW	A	K	"X"R
------	--------------	---------	-----	---	---	------

-08
-16
-24

-S
= 30 μ" (0.76 μm)
Gold on contact area,
Matte Tin on tail

-D
= Double
Row

-A
= Alignment
Pin

-K
= Polyimide
film Pick &
Place Pad

-TR
= Tape & Reel

-FR
= Full Reel
Tape & Reel
(must order
maximum quantity
per reel; contact
Samtec for
quantity breaks)

ARF6
Cable Mates:
ARC6

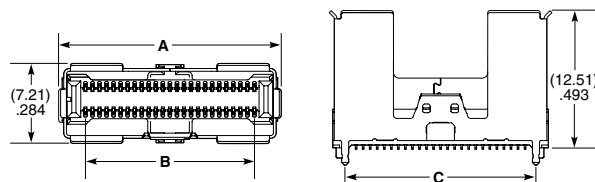

ARF6-16-S-D-A SHOWN

NO. OF PAIRS	A	B	C
-08	(12.46) .491	(7.62) .300	(9.59) .378
-16	(20.08) .791	(15.24) .600	(17.21) .678
-24	(27.70) 1.091	(22.86) .900	(24.83) .978

Notes:
Tape & Reel packaging and K-Dot are standard.

Some sizes, styles and options are non-standard, non-returnable.

View complete specifications at: samtec.com?ARF6

ACCELERATE[®] mini

EXTREME PERFORMANCE, MINI FORM FACTOR CABLE

(0.635 mm) .025" PITCH

NRZ	PAM4
56 Gbps	112 Gbps



VARIOUS END OPTIONS AVAILABLE



800G Flyover[®] QSFP Double Density

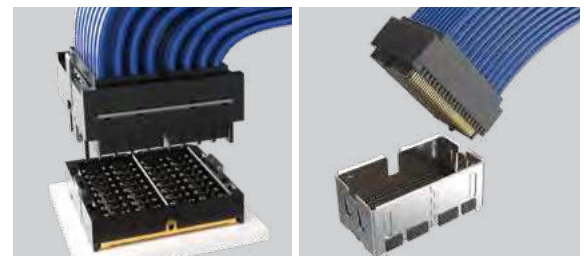

Si-Fly[™] HD

AcceleRate[®] HP Gen 2

FEATURES & BENEFITS

- 112 Gbps PAM4 performance
- Eye Speed[®] 34 AWG, 92 Ω Thinax[™] ultra performance twinax cable
- One or two differential pairs
- Vertical and right-angle mating board connector
- Design flexibility as an End 2 option for Flyover[®] assemblies
- Friction retention latching
- Standard alignment pins

KEY SPECIFICATIONS

CABLE	INSULATOR MATERIAL	CONTACT MATERIAL	PLATING	OPERATING TEMP RANGE	CURRENT RATING	VOLTAGE RATING
34 AWG, 92 Ω Thinax [™] ultra performance twinax	LCP	Copper Alloy	Au or Sn over 50 μ " (1.27 μ m) Ni	Testing Now!	Testing Now!	Testing Now!

(0.635 mm) .025" • MINI FORM FACTOR CABLE ASSEMBLY

ARM6	NO. OF PAIRS	CABLE LENGTH	END 1	END 2	WIRING OPTION	CABLE STYLE
------	--------------	--------------	-------	-------	---------------	-------------

-01, -02

-“XX.X”
= Length in Inches
03.0” (76.2 mm)
minimum

-LU
= Latch up

-LU
= Latch up

-LD
= Latch down

-1
= Pin 1 to Pin 1
(End 2 -LD only)

-4
= Pin 1 to Pin N
(End 2 -LU only)

-1
= 34 AWG
92 Ω
Eye Speed®
Thinax™

ARM6
Board Mates:
AMF6



PRELIMINARY

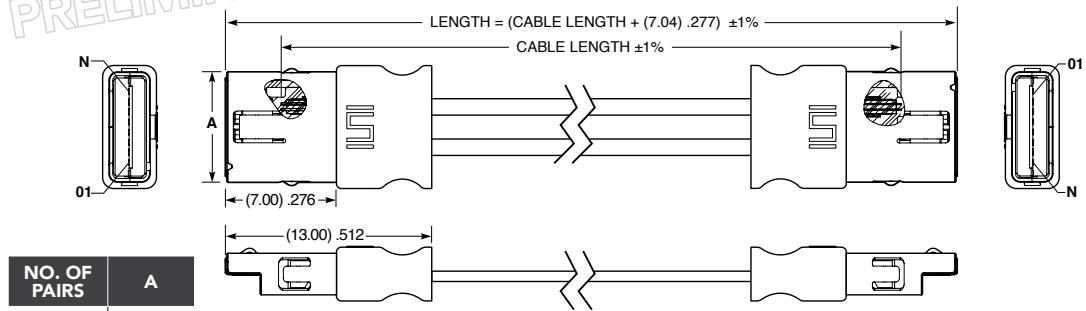

ARM6-02-XX.X-LU-LU-4-X SHOWN

Note:
Some sizes, styles and options are non-standard, non-returnable.

View complete specifications at: samtec.com?ARM6

AMF6	NO. OF PAIRS	PLATING	ROW OPTION	OPTION	“X”R
------	--------------	---------	------------	--------	------

-01, -02

-S
= 30 μ" (0.76 μm)
Gold on contact area,
Matte Tin on tail

(Leave blank for vertical)

(Leave blank for Right-angle)

-TR
= Tape & Reel

AMF6
Cable Mates:
ARM6

PRELIMINARY

NO. OF PAIRS	A	B	B (-RA)	C	C (-RA)
-01	(5.56) .219	(4.51) .176	(1.91) .075	(6.96) .274	(4.92) .194
-02	(8.10) .319	(7.05) .278	(4.75) .175	(9.50) .374	(7.46) .294

-RA
= Right-angle

-K
= (5.00 mm) .197" DIA
Polyimide film
Pick & Place Pad

-FR
= Full Reel Tape & Reel
(must order maximum quantity per reel; contact Samtec for quantity breaks)

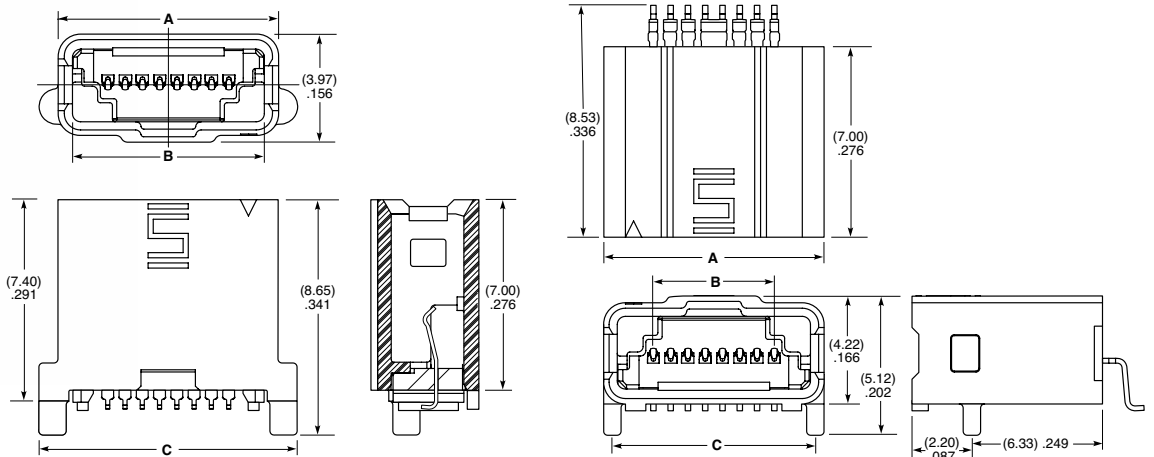

AMF6-02-S-K-XR SHOWN

AMF6-02-S-RA-XR SHOWN

Note:
Some sizes, styles and options are non-standard, non-returnable.

View complete specifications at: samtec.com?AMF6



112 Gbps PAM4, LOW PROFILE HIGH-DENSITY CABLE SYSTEM



NRZ	PAM4
56 Gbps	112 Gbps

FEATURES & BENEFITS

- Ultra low profile interconnect for placement adjacent to the IC package, under heat sinks or other cooling hardware
- Up to 16 pairs in an incredibly low 4 mm profile
- 112 Gbps PAM4 per lane enabling 25.6 TB aggregate with a path to 51.2 TB
- Si-Fly™ HD is the highest density on-package system with 224 Gbps PAM4 performance, routing signals from the silicon package through Eye Speed® AIR™ ultra performance twinax cable (HPC/HPI). Contact HDR@samtec.com for additional information.



Si-Fly™ HD features 64 pairs in an incredibly small 14 mm x 14 mm footprint

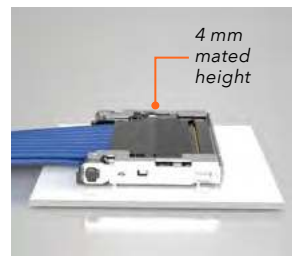
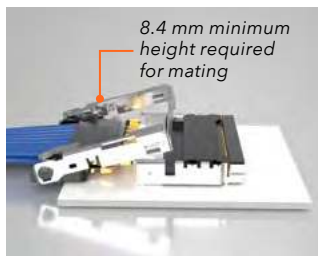

In development: Rugged latching configuration provides a secure connection directly adjacent to the IC package for increased signal integrity performance

KEY SPECIFICATIONS (CPC/CPI)

CABLE	SIGNAL ROUTING	INSULATOR MATERIAL	CONTACT MATERIAL	PLATING
34 AWG ultra low skew twinax	92 Ω & 100 Ω	Black LCP	Copper Alloy	Au over 50 μ" (1.27 μm) Ni

0.6 mm LOW PROFILE CABLE & INTERCONNECT

CPC	NO. OF PAIRS	CABLE STYLE	CABLE LENGTH	ROW	END 2	L	WIRING OPTION
	-08, -16	-1 = 92 Ω 34 AWG ultra low skew twinax cable -2 = 100 Ω 34 AWG ultra low skew twinax cable	-"XX.X" = Wire Length in Inches 06.0" (152.4 mm) minimum	-1 = 1 Row (-08 pairs only) -2 = 2 Row (-16 Pairs only)	-02 = CPC		Specify WIRING OPTION from chart

CPC
Board Mates:
CPI



PRELIMINARY

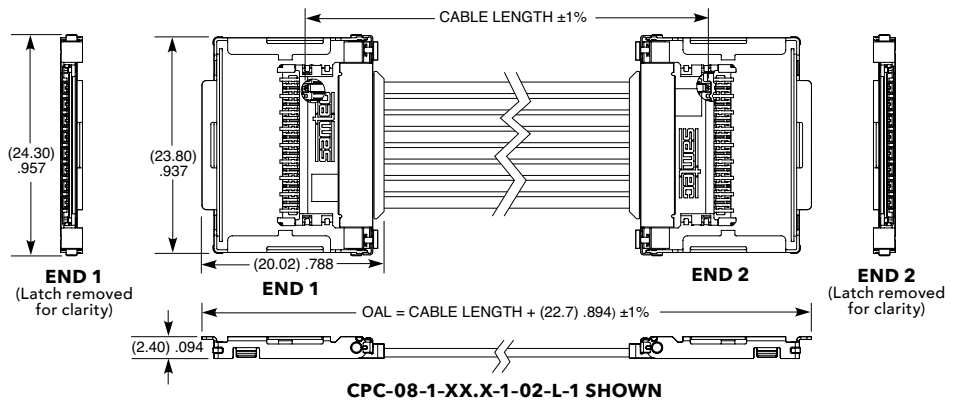

Note:
Cable lengths longer than 40.00" (1 meter) are not supported with S.I. test data.

View complete specifications at: samtec.com?CPC

CPI	NO. OF PAIRS	LEAD STYLE	ROW	PLATING OPTION	RA	SOLDER TYPE	L	"X"R
	-08, -16	-01 = Surface Mount	-1 = 1 Row, 8 Pairs -2 = 2 Row, 16 Pairs	-S = 30 μ" (0.76 μm) Gold on contact area, Tin on tail		-2 = Lead-Free Solder Ball		-TR = Tape & Reel -FR = Full Reel Tape & Reel (must order max. quantity per reel; contact Samtec for quantity breaks)

CPI
Cable Mates:
CPC

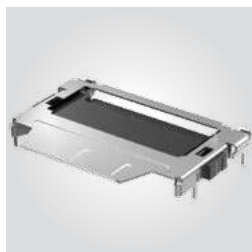

PRELIMINARY

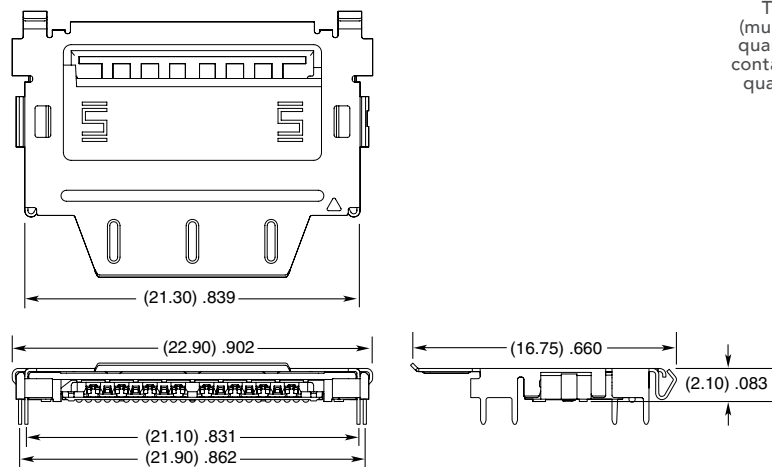

Note:
Some lengths, styles and options are non-standard, non-returnable.

View complete specifications at: samtec.com?CPI

EDGE CARD CABLE ASSEMBLIES

(0.60 mm) .024" PITCH • GC6 SERIES

PAM4
64
Gbps

GC6

Mates:
HSEC6-DV
(Shield (-S) option
required for mating)

SPECIFICATIONS

Cable:
34 AWG Eye Speed®
ultra low skew twinax

Signal Routing:
100 Ω Differential

Plating:
Au over 50 μ" (1.27 μm) Nickel

Operating Temp Range:
Testing Now!

Current Rating:
Testing Now!

Protocols:
SFF-TA-1002 Compatible

GC6	NO. OF POSITIONS	WIRE LENGTH	END NO. 1	END NO. 2	WIRE MAPPING	CABLE TYPE
	-028 = 28 positions (1C)	-“XX.X” = Wire Length in Inches 06.0” (152.4 mm) minimum	-SU = Straight, Latch Up	-SD = Straight, Latch Down	-1 = Pin A1 to Pin A1	-2 = 34 AWG 100 Ω ultra low skew twinax cable
	-042 = 42 positions (2C)		-RU = Right- angle, Latch Up	-RD = Right- angle, Latch Down (Not available with -SU option)		
	-070 = 70 positions (4C)					

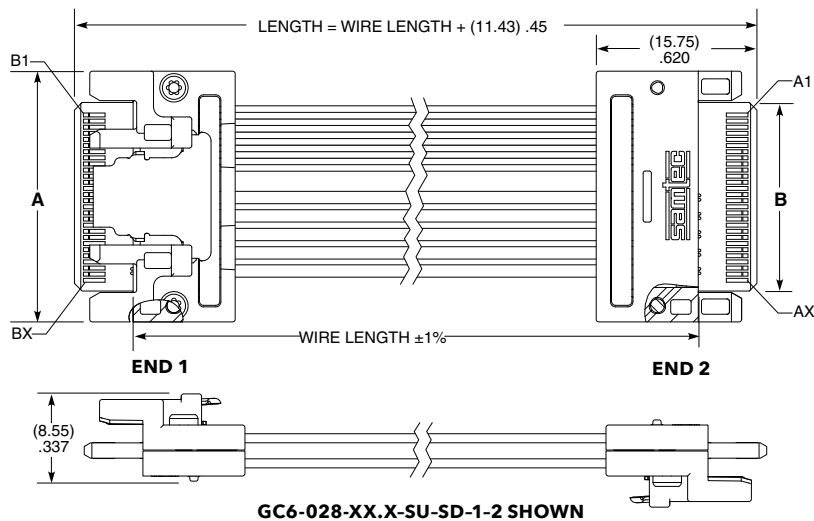

POSITIONS PER ROW	A	B	X
-028	(24.57) .967	(18.480) .728	28
-042	(36.29) 1.429	(30.170) 1.188	42
-070	(57.71) 2.272	(51.280) 2.019	70

Notes:

Cable lengths longer than 40.00" (1 meter) are not supported with S.I. test data.

Design your full cable assembly with Samtec's High-Speed Cable Solutionator® at www.samtec.com/cablebuilder

Some lengths, styles and options are non-standard, non-returnable.

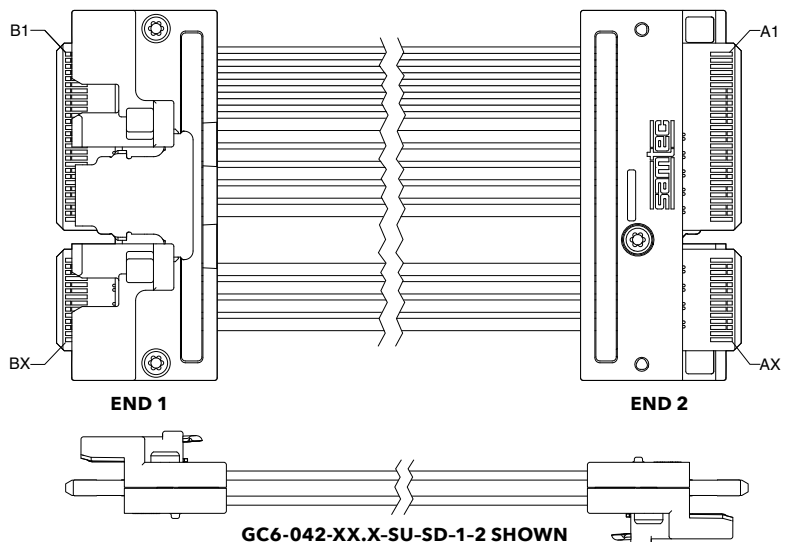

HIGH-SPEED CABLE ASSEMBLIES

MIX-AND-MATCH FLEXIBILITY • MICRO COAX & TWINAX CABLE • PCI EXPRESS® 2.0/3.0/4.0/5.0

122-123

SEARAY™ HIGH-SPEED,
HIGH-DENSITY CABLE SYSTEM
(SEAC)



124

COPPER FIREFLY™
MICRO FLYOVER SYSTEM™
(ECUE, PCUE)



125

PCI EXPRESS® EDGE CARD SYSTEMS
(PCIEC-G4, PCIEC-G5)



126

PCI EXPRESS® HIGH-SPEED TEST
CABLES (PCRF-G4, PCRF-G5)

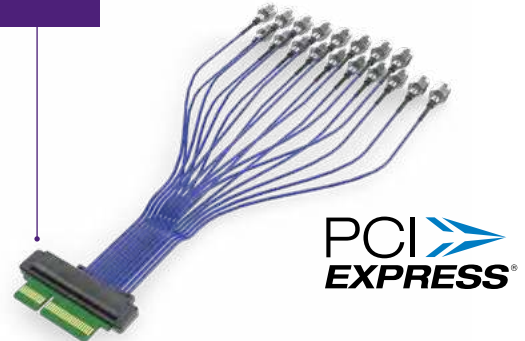

127

GENERATE™
HIGH-SPEED TEST
CABLE (GC6-RF)

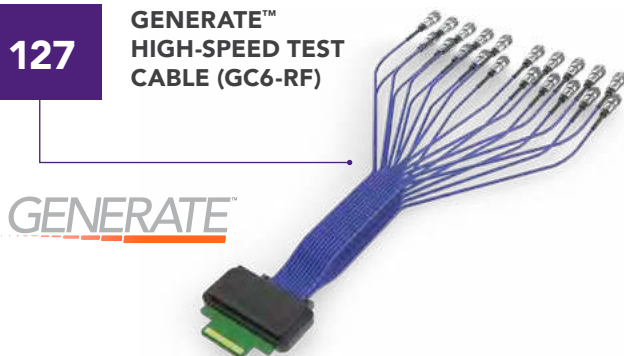

128

ADDITIONAL HIGH-SPEED
CABLE SOLUTIONS

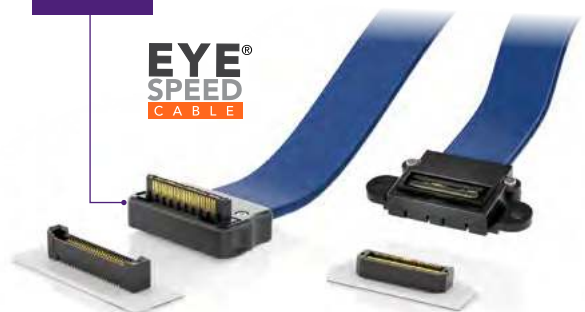

HIGH-SPEED CABLE ASSEMBLIES

MICRO COAX & TWINAX ASSEMBLIES • EYE SPEED® CABLE TECHNOLOGY • DESIGN FLEXIBILITY
EASY CUSTOMS & EXPRESS MODIFICATIONS • WILLINGNESS, SUPPORT & EXPERTISE

MICRO COAX & TWINAX CABLE ASSEMBLIES

- Ability to mix-and-match end options for application-specific requirements with extensive customizing capabilities
- Single-ended 50 Ω & differential 100 Ω standards
- Rugged features and options including strain relief, plastic housings, screw downs, latches, locks, etc.
- Many non-cataloged standards available including 75 Ω micro coax and high-density twinax solutions

14
G b p s



EYE SPEED® CABLE TECHNOLOGY

- Samtec's Eye Speed® cable supports a wide variety of assemblies and applications
- Excellent signal integrity performance with individual copper serve or copper tape shielding
- Stranded conductor for small bend radii and dynamic high flexing cycle applications
- Cost-effective ribbonizing eliminates discrete wires
- 26 – 38 AWG coax and twinax construction; 20 Ω , 50 Ω , 85 Ω & 100 Ω

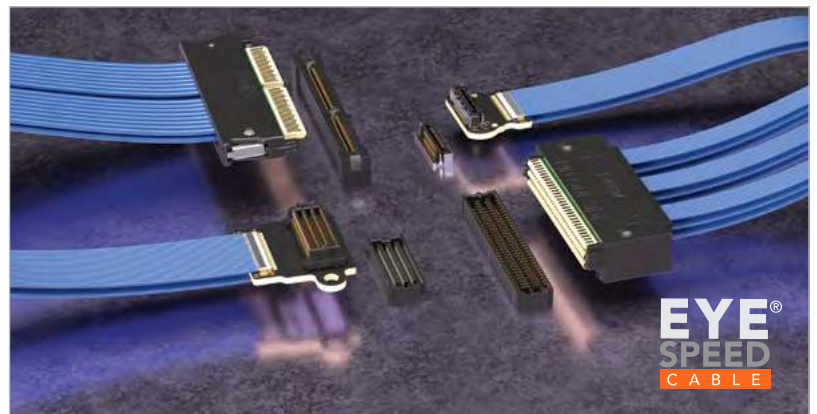

HIGH-SPEED CABLE SOLUTIONATOR® ONLINE DESIGN TOOL

Quickly design full cable assemblies using a wide variety of user-defined search parameters and filters, view models and specifications, request samples and pricing, or place an order – all in Samtec's Solutionator® online design tool.

Visit [samtec.com/cablebuilder](https://www.samtec.com/cablebuilder) to get started!

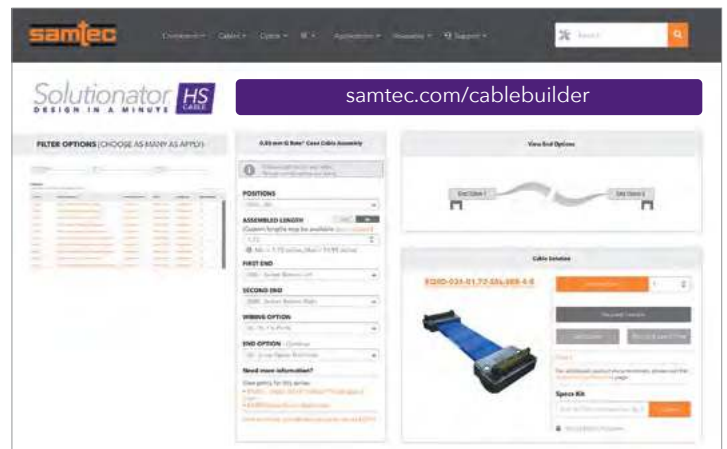

DESIGN FLEXIBILITY



ANY
high-speed **connector**

ANY
break-out **configuration**

ANY
high-speed **precision cable**

... to create a solution for
any specific application.

HDR@samtec.com

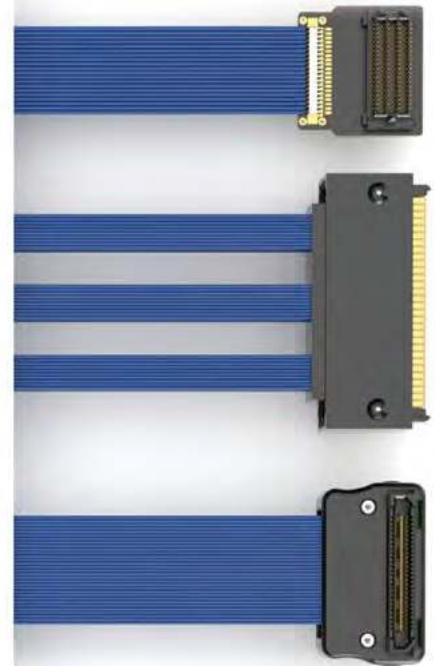

CUSTOMS & EXPRESS MODIFICATIONS

Samtec is able to support new and custom designs, as well as simple modifications to cable assemblies and board-to-board products – often with low or no NRE charges, short lead times, quick-turn samples, and low or no MOQ's. Visit samtec.com/customs for additional details.

- Wiring
- Molding
- Plating
- Polarization
- Contacts
- Bodies
- Stamping
- Ruggedizing features
- Packaging
- Labeling
- Ink printing
- Shielding modifications



WILLINGNESS, SUPPORT & EXPERTISE

- Engineering, design and prototype support
- Design simulation and processing assistance
- Global Operations, including multiple cable fabrication/assembly facilities
- Quotes and samples turned around in 24 hours
- Flexible, quick-turn manufacturing
- Dedicated Application Specific Product engineers and technicians

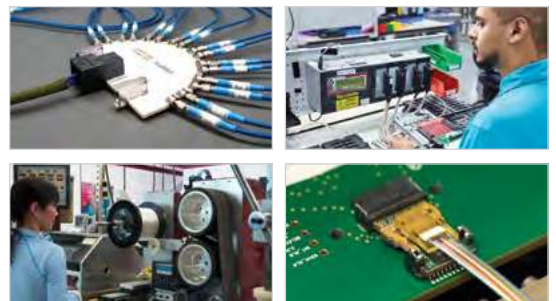

SEARAY™

HIGH-SPEED, HIGH-DENSITY CABLE ASSEMBLY

(1.27 mm) .050" PITCH



14
G b p s

FEATURES & BENEFITS

- 14 Gbps performance
- Up to 240 I/Os (1/2 of pins are dedicated to ground)
- 4, 6, 8 and 10 row designs
- Choice of Eye Speed® 36 AWG 50 Ω micro coax or 32 AWG 100 Ω twinax cable
- Positive latching when mated to SEAFC with latching post option
- Supports PCIe® 2.0 and 3.0 protocols



Guide post latching available for more rugged applications



Vertical board level mate (SEAFC); samtec.com?seafc



Eye Speed® cable for excellent signal integrity performance

KEY SPECIFICATIONS (SEAC)

CABLE	INSULATOR MATERIAL	CONTACT MATERIAL	PLATING	OPERATING TEMP RANGE	CURRENT RATING	VOLTAGE RATING
36 AWG 50 Ω micro coax or 32 AWG 100 Ω twinax cable	Black LCP	Copper Alloy	Au or Sn over 50 μ" (1.27 μm) Ni	-40 °C to +125 °C (coax) -25 °C to +105 °C (twinax)	0.4 A Specified Cable Rating	120 VAC

(1.27 mm) .050" PITCH • HIGH DENSITY CABLE

SEAC	NO. OF POSITIONS PER ROW	NO. OF ROWS	CABLE LENGTH	TU	TU	CABLE TYPE	LATCH OPTION
	-020 (-04, -06, -08 & -10 row only)	-04, -06, -08, -10	-"XX.X" = Cable Length in Inches (101.6 mm) 04.0" minimum			Leave Blank for 36 AWG 50 Ω coax	Leave Blank for latch post
	-030 (-04, -06 & -08 row only)						-N = No Latch
	-040 (-04 & -06 row only)						
	-050 (-04 row only)					-2 = 32 AWG 100 Ω twinax	

SEAC
Mates:
SEAF8



SIGNAL ROUTING

Product has some lines dedicated to ground. For single-ended and differential pair signal/ground assignments see signal routing information on the assembly print at www.samtec.com?seac Design your High-Speed Cable with Samtec's High-Speed Cable Solutionator[®] at www.samtec.com/cablebuilder

OTHER SOLUTIONS

Other end options
Mixed SEAC end types
300 positions or greater

Notes:
Mixed latch styles not available

Cable lengths longer than 40.00" (1 meter) are not supported with S.I. test data.

PCIe[®] 2.0 & 3.0 capable

PCI-SIG[®], PCI Express[®] and the PCIe[®] design marks are registered trademarks and/or service marks of PCI-SIG.

Some lengths, styles and options are non-standard, non-returnable.

POSITIONS PER ROW	A	B	C
-020	(30.38) 1.196	(33.53) 1.320	(48.26) 1.900
-030	(43.08) 1.696	(46.23) 1.820	(60.96) 2.400
-040	(55.78) 2.196	(58.93) 2.320	(73.66) 2.900
-050	(68.48) 2.696	(71.63) 2.820	(86.36) 3.400

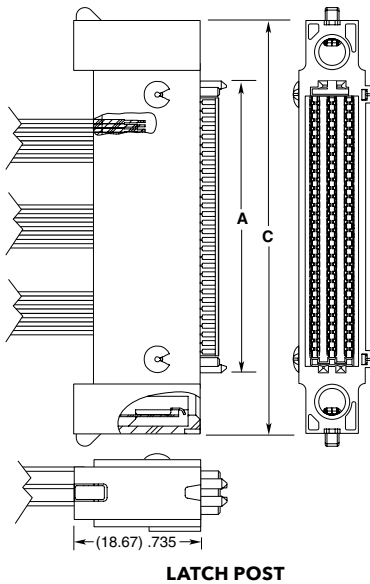
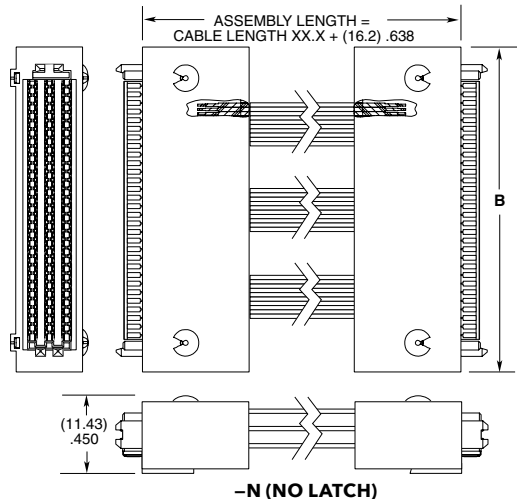

SEARAY™ 0.80 mm CABLE ASSEMBLY

(0.80 mm) .0315" pitch High-Speed Cable in 8 to 10 rows that mates with the SEAM8/SEAF8 Series.

For more information on the ESCA Series, visit samtec.com?ESCA

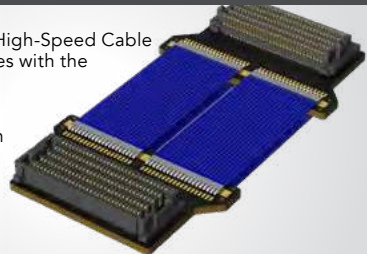



COPPER MICRO FLYOVER SYSTEM™

28
Gbps

ECUE/PCUE SERIES



ECUE

Mates:
UEC5, UCC8

SPECIFICATIONS

Cable:
36 AWG twinax cable
34 AWG twinax cable
34 AWG ultra low skew twinax cable
Signal Routing:
100 Ω Differential
Bend Radius:
(3.18 mm) .125"

SERIES	NO OF PAIRS	ASSEMBLY LENGTH	CABLE TYPE	END 2 OPTION	WIRING OPTION	DATA RATE	OPTION
ECUE = Rugged FireFly™ Cable Assembly	-08 = Eight Pair (-T2 & -T3 cable only)	-"XXX" = Assembly Length in Centimeters (007 cm to 999 cm)	-T1 = 36 AWG twinax (-12 pairs only)	-FF = FireFly™ (Mates with UEC5/UCC8)	-01 = Pin A1 to Pin A19	-1 = 14 Gbps (-T1 or -T2 only)	Leave blank for standard FireFly™
	-12 = Twelve Pair (-T1 cable only)		-T2 = 34 AWG twinax (-08 pairs only)		-02 = Pin A1 to Pin B1	-2 = 28 Gbps (-T3 only)	-D1 = Decoupling Capacitors (only available with -02 & -B4 wire options)
			-T3 = 34 AWG ultra low skew twinax (-08 pairs only)		-B4 = Pin A1 to Pin B19 (-08 pair only)		

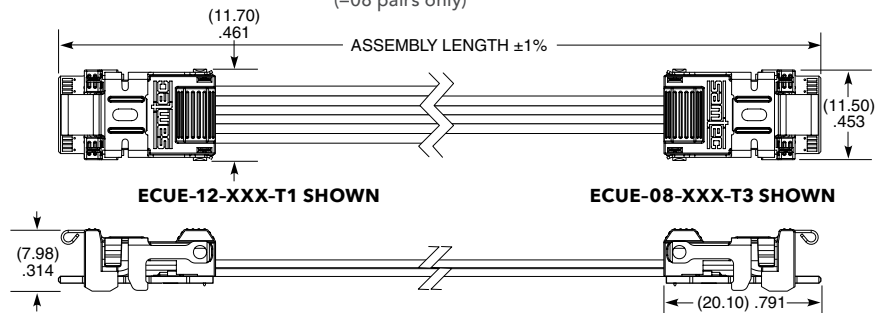

Notes:
All FireFly™ designs, specifications and components are subject to change without notice.

Cable lengths longer than 150 cm (59.06") are not supported with S.I. test data.

View complete specifications at: samtec.com?ECUE

PCUE

Mates:
UEC5, UCC8

SPECIFICATIONS

Cable:
34 AWG ultra low skew twinax
Signal Routing:
100 Ω
Bend Radius:
(3.18 mm) .125"

SERIES	DATA RATE	NO. OF CHANNELS	ASSEMBLY LENGTH	END 2
PCUE = PCIe®-over-FireFly™ Copper Cable Assembly	-G4 = 4.0 Speed	-04 = 8 pairs	-"XXX" = Assembly Length in Centimeters (010 cm to 999 cm)	-FF = FireFly™ (Mates with UEC5/UCC8)

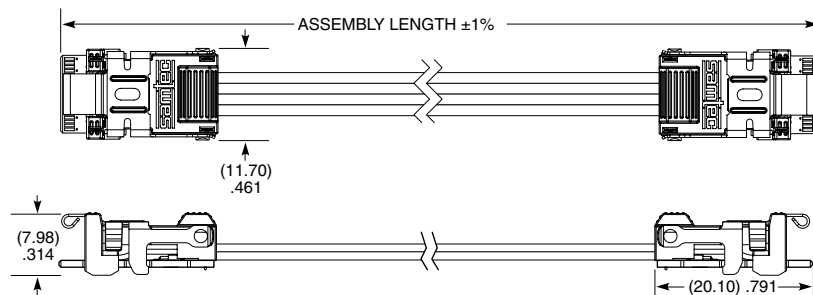

Notes:
Supports PCIe® sideband signals

Decoupling capacitors in-line with signals on PCB.

PCI-SIG®, PCI Express® and the PCIe® design marks are registered trademarks and/or service marks of PCI-SIG.

Some sizes, styles and options are non-standard, non-returnable.

View complete specifications at: samtec.com?PCUE

PCI EXPRESS® CABLE ASSEMBLY

(1.00 mm) .0394" PITCH • PCIEC-G4/PCIEC-G5 SERIES



PCIEC-G4

Mates:
PCIE-G4

PCIEC-G5

Mates:
PCIE-G5

SPECIFICATIONS

Cable:
Eye Speed® 34 AWG Twinax;
30 AWG insulated ribbon

Operating Temp:
-25 °C to +105 °C

Contact:
Copper Alloy

Plating:
Au or Sn over 50 μ" Ni

Performance:
Supports PCIe® 4.0 & 5.0

Bend Radius:
(3.18 mm) .125"

PCIEC	GENERATION	NO. OF POSITIONS	WIRE LENGTH	END NO. 2	CABLE OPTION	IMPEDANCE
-------	------------	------------------	-------------	-----------	--------------	-----------

-G4
= PCIe® 4.0

-036 (x1),
-064 (x4),
-098 (x8),
-164 (x16)

-"XXXX"
= Wire Length in millimeters 0076 mm minimum

-C1
= PCIe® Edge Card (Tx to Tx extender)

Leave blank for no power

Leave blank for 100 Ω

-G5
= PCIe® 5.0

-C2
= PCIe® Edge Card (Tx to Rx crossover)

-P
= Power

-M1
= PCIeC Edge Mount Socket (Tx to Tx extender) (Not available with -G5)

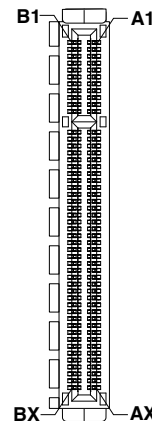
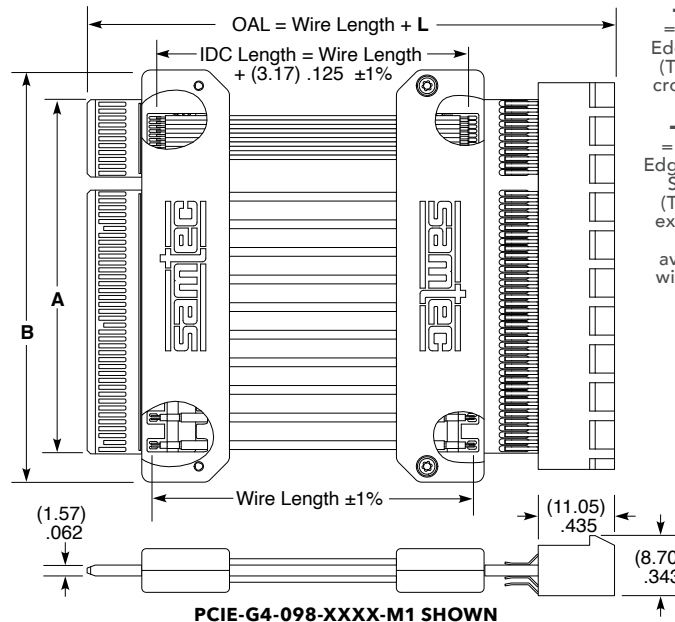

CABLE OPTION	IMPEDANCE	
	85 Ω	100 Ω
BLANK	34 AWG Taped Shield	
-P (With Power Lines)	34 AWG Taped Shield	

* Contact hdr@samtec.com for information

END TO END	L
-C1 to -C1	(18.60) .732
-C1 to -C2	(42.69) 1.68
-C1 to -M1	(29.64) 1.167

NO. OF POSITIONS	X	A	B
-036 (x1)	18	(20.30) .799	(28.69) 1.13
-064 (x4)	32	(34.30) 1.35	(42.69) 1.68
-098 (x8)	49	(51.30) 2.02	(59.69) 2.35
-164 (x16)	82	(84.30) 3.32	(92.69) 3.65

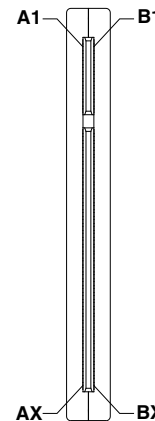
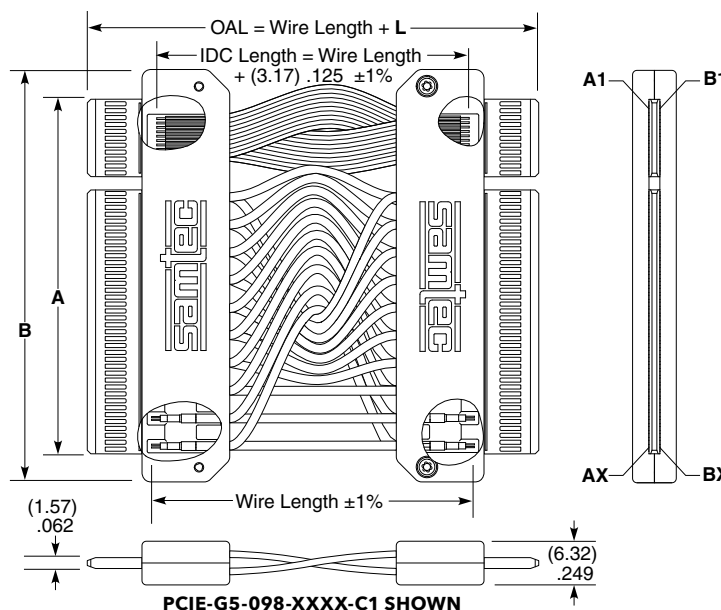

ALSO AVAILABLE

For speeds of PCIe® 2.0 & 3.0, visit www.samtec.com?PCIEC

Notes:
Cable lengths longer than 1015 millimeters are not supported with S.I. test data.

Design your full cable assembly with Samtec's High-Speed Cable Solutionator® at www.samtec.com/cablebuilder

PCI-SIG®, PCI Express® and PCIe® design marks are registered trademarks and/or service marks of PCI-SIG

This Series is non-standard, non-returnable.

PCI EXPRESS® HIGH-SPEED TEST CABLE

PCRF-G4/PCRF-G5 SERIES

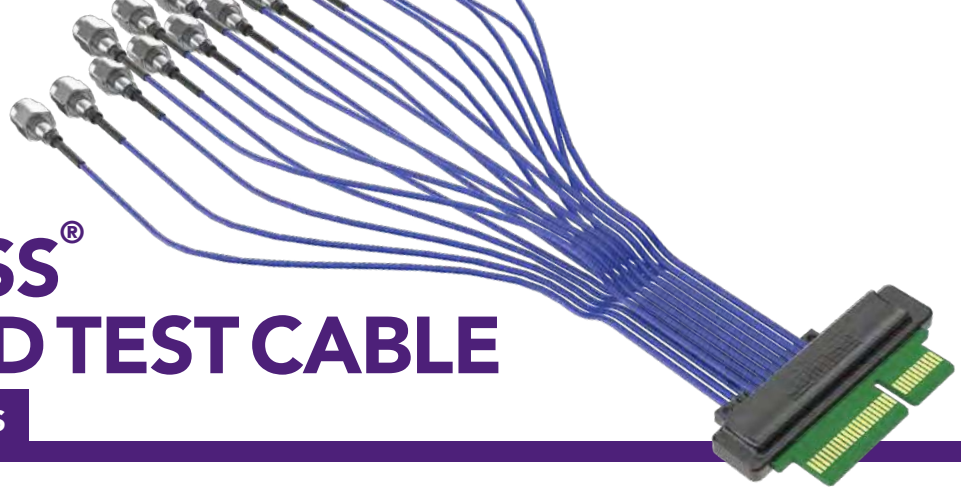

PCRF

Mates:
PCIE-G4, PCIE-G5, 292

SPECIFICATIONS

Card:

Conductor:
1/2 oz. Copper
Contact Area:
Hard Gold
Insulator:
Megtron 6

Cable:

Type:
Low Loss Microwave Coax
Gauge:
29 AWG Silver Plated Copper
Signal Conductor:
(.287) .0113" DIA
Overall Shield Diameter:
(1.17 mm) .046" DIA
Jacket Material:
FEP
Impedance:
50 Ω
Bend Radius:
10.0 Min
Capacitance:
29 pF/foot
Operating Temp:
-65 °C to 150 °C
Frequency Range:
DC to 110 GHz

PCRF	GENERATION	NO. OF POSITIONS	WIRE LENGTH	END OPTION	RF CONNECTOR	RF GENDER	COAX
	-G4 = PCIe® 4.0	-036, -064, -098, -164 (Per Row)	-"XXXX" = Wire Length in millimeters 0152 mm (06.0") MIN 1000 mm (39.4") MAX	-EC = PCIe® Edge Card -EM = PCIe® Edge Mount (-G4 only)	-292 = 2.92 mm Connector	-P = Plug -J = Jack	-1 = 31 AWG

NO. OF POSITIONS	A	B	N	NO. OF COAX
-036	(20.30) .800	(35.54) 1.40	18	6
-064	(34.30) 1.35	(49.54) 1.95	32	18
-098	(51.30) 2.02	(66.54) 2.62	49	34
-164	(84.30) 3.32	(99.54) 3.92	82	66

ALSO AVAILABLE

PCI Express® cable with SMAs for debug; visit samtec.com?PCRF

Notes:

Cable lengths longer than 40.00" (1 meter) are not supported with S.I. test data.

Design your full cable assembly with Samtec's High-Speed Cable Solutionator® at www.samtec.com/cablebuilder

PCI-SIG®, PCI Express® and the PCIe® design marks are registered trademarks and/or service marks of PCI-SIG

This Series is non-standard, non-returnable.

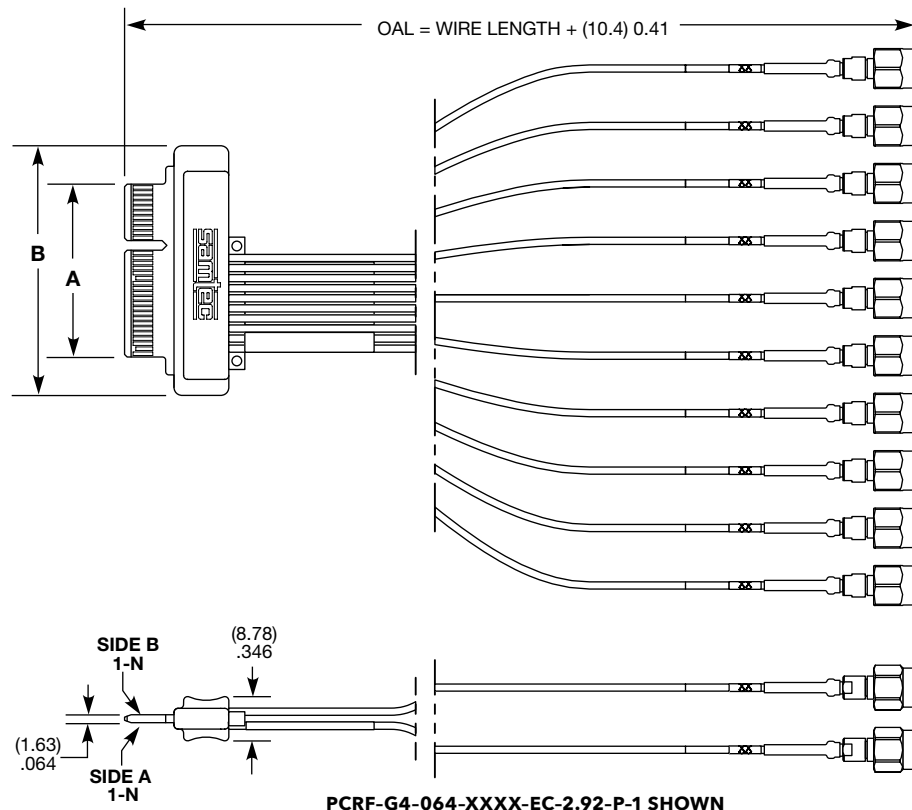

GENERATE™

GENERATE™ HIGH-SPEED TEST CABLE

GC6-RF SERIES

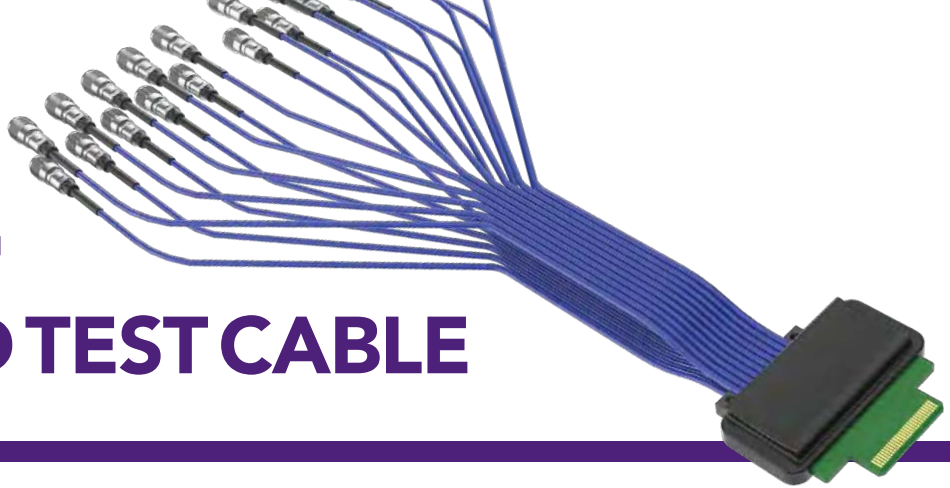

GC6

Mates:
HSEC6-DV, 292

SPECIFICATIONS

Card:

Conductor:
1/2 oz. Copper
Contact Area:
Hard Gold
Insulator:
Megtron 6

Cable:

Type:
Low Loss Microwave Coax
Gauge:
29 AWG Silver Plated Copper
Signal Conductor:
(.287) .0113" DIA
Overall Shield Diameter:
(1.17 mm) .046" DIA
Jacket Material:
FEP
Impedance:
50 Ω
Bend Radius:
10.0 Min
Capacitance:
29 pF/foot
Operating Temp:
-65 °C to 150 °C
Frequency Range:
DC to 110 GHz

GC6	RF	NO. OF POSITIONS	WIRE LENGTH	END OPTION	RF CONNECTOR	RF GENDER	COAX
-----	----	------------------	-------------	------------	--------------	-----------	------

-028 (1C),
-042 (2C),
-070 (4C)
(Per Row)

-"XXXX"
= Wire Length
in millimeters
0152 mm
(06.0") MIN
1000 mm
(39.4") MAX

-EC
= Edge
Card

-292
= 2.92 mm
Connector

-P
= Plug

-J
= Jack

-1
= 31 AWG

PRELIMINARY

NO. OF POSITIONS	A	B	N	NO. OF COAX
-028	(18.48) .728	(39.18) 1.54	28	20
-042	(30.17) 1.19	(50.87) 2.00	42	36
-070	(51.28) 2.02	(71.98) 2.83	70	68

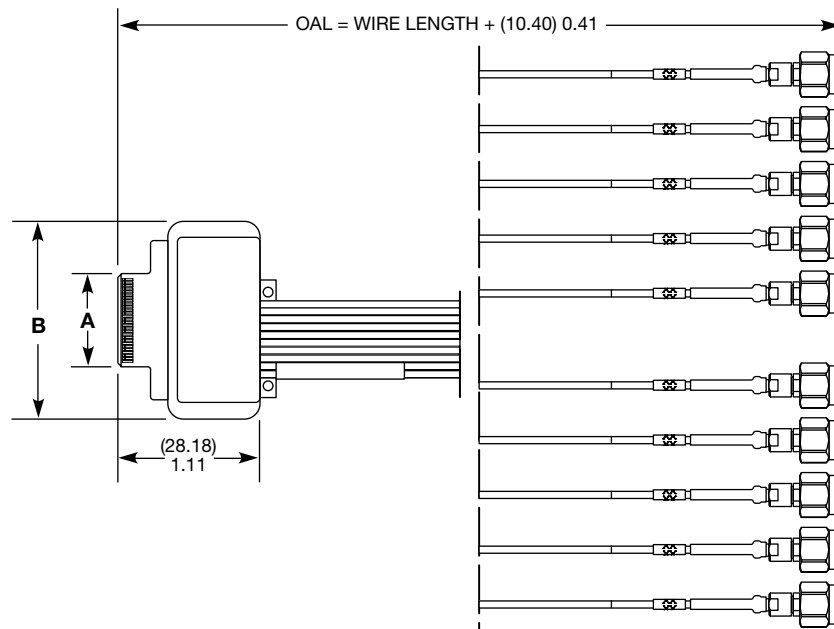

Notes:

Cable lengths longer than 40.00" (1 meter) are not supported with S.I. test data.

Design your full cable assembly with Samtec's High-Speed Cable Solutionator® at www.samtec.com/cablebuilder

This Series is non-standard, non-returnable.

GC6-RF-028-XXXX-EC-292-P-1 SHOWN

ADDITIONAL HIGH-SPEED CABLE ASSEMBLIES

Ground Plane Assemblies

- Integral power/ground plane
- 34 and 38 AWG coax; 30 and 32 AWG twinax
- 0.50 mm pitch (HQCD/HQDP) and 0.80 mm pitch (EQCD/EQDP) assemblies with rugged screw mount or retention pin options
- 0.80 mm pitch (EQRD) assembly with Edge Rate® contacts for reduced broadside coupling
- Mates with Q Series® and Q Rate® connectors



View complete specifications at:

samtec.com?HQCD | samtec.com?HQDP | samtec.com?EQCD | samtec.com?EQDP | samtec.com?EQRD

Edge Card Assemblies

- 30 AWG twinax (ECDP); mates with Generate™ 0.80 mm pitch edge cards (HSEC8)
- Available without housing for cost savings
- 34 AWG ultra low skew twinax (FEDP); mates with 0.50 mm pitch edge card (FCDP)
- 16 Gbps NRZ performance, to 56 Gbps PAM4 when paired with FQSFP Series or FQSFP-DD Series



View complete specifications at: samtec.com?ECDP | samtec.com?FEDP

High-Speed Assemblies

- Ultra-micro hermaphroditic Razor Beam™ coax assemblies with rugged shielding (HLCD)
- Mates with 0.50 mm pitch Razor Beam™ connectors
- 0.80 mm pitch Edge Rate® coax and twinax assemblies (ERCD, ERDP)
- Low-cost 0.80 mm pitch coax cable system in a compact form factor (FCF8/FCS8)
- 38 AWG coax & 30 AWG twinax assemblies



View complete specifications at:

samtec.com?HLCD | samtec.com?ERCD | samtec.com?ERDP | samtec.com?FCF8 | samtec.com?FCS8

OPTICS

FUTURE PROOF • HIGH PERFORMANCE • PCI EXPRESS® • END OPTION FLEXIBILITY

130-133 FIREFLY™ MICRO FLYOVER SYSTEM™
(ECUO, ETUO, ETMO)



134 PCI EXPRESS®-OVER-FIBER FIREFLY™
SYSTEM (PCUO, PTUO)

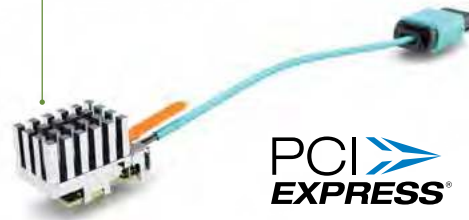

136 PCI EXPRESS®-OVER-FIBER FIREFLY™
ADAPTOR CARD (PCOA)



137 OPTICAL PATCH CABLE & ADAPTOR
(FOPC, OPA)

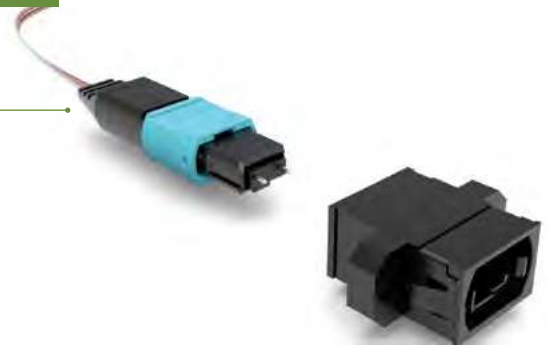

138 FIREHAWK™ RUGGEDIZED OPTICAL
TRANSCEIVERS (RVCN, CSPO, CSSO)

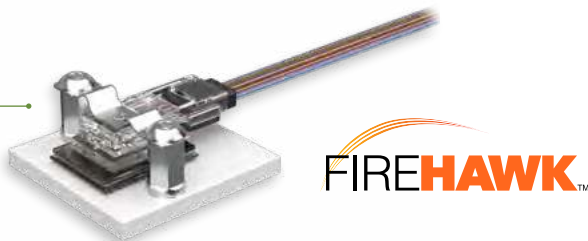

139 HALO™ NEXT GEN OPTICAL (HALO)

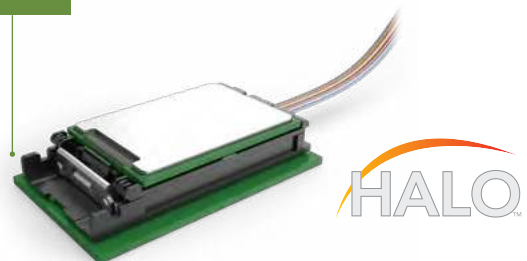

FIREFLY™ MICRO FLYOVER SYSTEM™



FEATURES & BENEFITS

- Data connection taken “off board” simplifies board layout
- Industry leading miniature footprint allows for higher density close to data source
- Performance up to 28 Gbps per lane with a path to 112 Gbps PAM4 via optical cable for greater reach
- Simple assembly process with easy insertion/removal and trace routing, no through-holes
- Interchangeability of copper and optical cable using the same two-piece surface mount connector
- PCIe®-Over-Fiber (PCUO/PTUO) supports PCIe® protocol for low latency, power savings and guaranteed transmission; 3.0 and 4.0 solutions
- -40 °C to +85 °C extended temperature system (ETUO) for military, aerospace and industrial applications
- Extreme Environment FireFly™ sealed and parylene-coated for exposed applications (ETMO)
- Multiple end options available: MTP®, MCX®, MT, VITA 66.X and other common interfaces
- Variety of integral heat sinks for conduction and convection cooling



Micro two-piece connector system

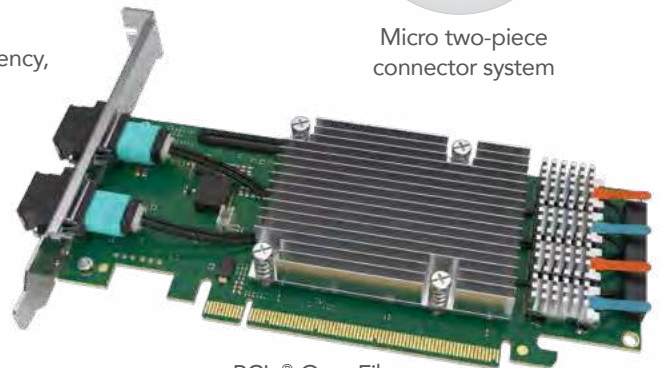

PCIe®-Over-Fiber Adaptor Card

PRODUCT ROADMAP

Advanced Optics

Samtec is focused on bringing to market 112 Gbps PAM4 solutions that are scalable, manufacturable and cost-efficient.

Immersion Cooling

Capable of immersion for liquid cooled systems.

Direct Connect™

On-package interconnect enables 56 Gbps PAM4 performance, eliminates distortion through the BGA region and improves density.



PCI-SIG®, PCI Express® and the PCIe® design marks are registered trademarks and/or service marks of PCI-SIG.



OPTICAL MICRO FLYOVER SYSTEM™

ECUO	WIDTH	DATA RATE	CABLE LENGTH	0	HEAT SINK	1	FIBER TYPE	END 2 OPTIONS
	-B04 = 4 Tx + 4 Rx -T12 = 12 Tx -R12 = 12 Rx -Y12 = 12 Tx + 12 Rx -U12 = 12 Channel AOC (Unidirectional)	-14 = 14 Gbps per lane -16 = 16.1 Gbps per lane (N/A -B04) -25 = 25.7 Gbps per lane -28 = 28.1 Gbps per lane (-B04 only)	-"XXX" = Overall Length in Centimeters		-1 = Flat -2 = Pin-fin (-14 & -16 only) -3 = Flat with groove -4 = PCIe® Pin-fin (-14 & -16 only) -5 = 1.75 cm tall Pin-fin (-B04 only)		-4 = Aqua loose tube with boot -5 = Jacketed ribbon with boot -6 = Jacketed ribbon -7 = Black loose tube with boot -8 = Black loose tube	(Leave blank for -U12) -Y12 requires -2X end option 12 Fibers -01 = MTP® Male -02 = MTP® Female -07 = MXC® Internal Plug* -0E = MPO Plus®, Male, bayonet 24 Fibers -21 = MTP® Male -22 = MTP® Female -27 = MXC® Internal Plug* -2E = MPO Plus®, Male, bayonet

ECUO
Mates with:
UEC5, UCC8,
OPA

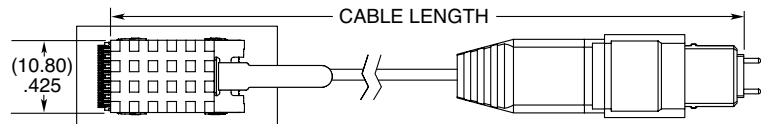

FEATURES

- Supports data center and HPC protocols, including: Ethernet, InfiniBand™, Fibre Channel
- Customizable optical connectors
- Integrated coupling capacitors
- Standard temperature range 0 °C to +70 °C
- Evaluation & Development boards available

CLASS 1 LASER PRODUCT
per IEC 60825-1 Ed. 3 (2014)

Applies to all end 2 options except MXC®

TOOLING

Insertion Tool: CAT-IN-ECUO-02

Notes:
MTP® is a registered trademark of US Conec Ltd.

PCI-SIG®, PCI Express® and PCIe® design marks are registered trademarks and/or service marks of PCI-SIG.

All FireFly™ designs, specifications and components are preliminary and subject to change without notice.

Some lengths, styles and options are non-standard, non-returnable.

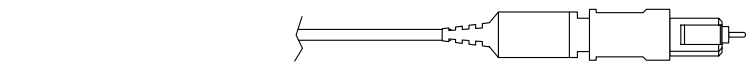

-01 (MTP® MALE SHOWN)

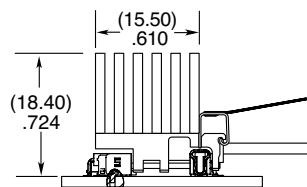

-2 PIN-FIN HEAT SINK

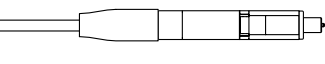

-07 (MXC® INTERNAL PLUG SHOWN)

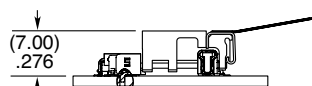

-1 FLAT HEAT SINK

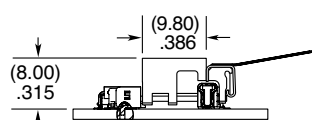

-3 FLAT WITH GROOVE HEAT SINK (MULTI-ROW CONFIGURATION)

***CLASS 3R LASER PRODUCT**
Laser Radiation. Avoid Direct Eye Exposure.



Applies to MXC® end option only.

View complete specifications at: samtec.com?ECUO



EXTENDED TEMP OPTICAL MICRO FLYOVER SYSTEM™

ETUO	WIDTH	DATA RATE	CABLE LENGTH	0	HEAT SINK	1	FIBER TYPE	END 2 OPTIONS
	-B04 = 4 Tx + 4 Rx -T12 = 12 Tx -R12 = 12 Rx -Y12 = 12 Tx + 12 Rx -U12 = 12 Channel AOC (Unidirectional)	-10 = 10.3125 Gbps -25 = 25.7 Gbps (-B04 only)	"XXX" = Overall Length in Centimeters		-1 = Flat -2 = Pin-fin -3 = Flat with groove -4 = PCIe® Pin-fin (-10 only) -5 = 1.75 cm tall Pin-fin (-B04 only)		-5 = Jacketed ribbon with boot -6 = Jacketed ribbon -7 = Black loose tube with boot -8 = Black loose tube	(Leave blank for -U12) -Y12 requires -2X end option 12 Fibers -01 = MTP® Male -02 = MTP® Female -07 = MXC® Internal Plug* -0A = VITA 66.X Ready -0C = MT38999 Male -0E = MPO Plus®, Male, bayonet 24 Fibers -21 = MTP® Male -22 = MTP® Female -27 = MXC® Internal Plug* -2A = VITA 66.X Ready -2C = MT38999 Male -2E = MPO Plus®, Male, bayonet

ETUO
Mates with:
UEC5, UCC8,
OPA

FEATURES

- Optimized for SWaP
- Extended temperature range from -40 °C to +85 °C
- Demonstrated error free transmission during applied external vibrations and shock test, to methods specified in MIL-STD-810G
- Micro rugged board level connector system with positive latching, weld tabs and loading guides for secure connection
- Pigtailed cable for maximum link budget
- Customizable optical connectors
- Integrated coupling capacitors
- Integral heat sink provides optimal cooling for thermal operating conditions
- Evaluation and Development boards available

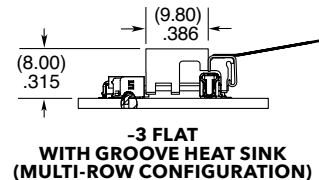
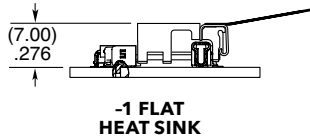
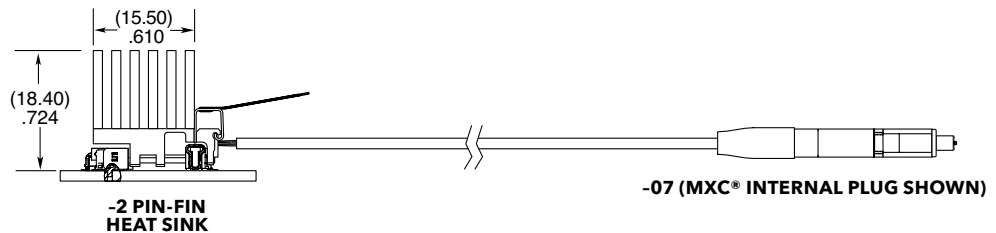

CLASS 1 LASER PRODUCT
per IEC 60825-1 Ed. 3 (2014)
Applies to all end 2 options except MXC®

Notes:
MTP® is a registered trademark of US Conec Ltd.

PCI-SIG®, PCI Express® and the PCIe® design marks are registered trademarks and/or service marks of PCI-SIG.

All FireFly™ designs, specifications and components are preliminary and subject to change without notice.

Some lengths, styles and options are non-standard, non-returnable.

***CLASS 3R LASER PRODUCT**
Laser Radiation. Avoid Direct Eye Exposure.



Applies to MXC® end option only.

View complete specifications at: samtec.com?ETUO



EXTREME ENVIRONMENT OPTICAL MICRO FLYOVER SYSTEM™

ETMO	B04	DATA RATE	CABLE LENGTH	0	HEAT SINK	FIRMWARE	FIBER TYPE	END 2 OPTIONS
		-10 = 10.3125 Gbps	-“XXX” = Overall Length in Centimeters		-1 = Flat	-1 = Standard	-5 = Black Jacketed ribbon with boot	(Leave blank for AOC)
		-25 = 25.7 Gbps			-2 = Pin-fin	-3 = Dual Power	-6 = Black Jacketed ribbon	-01 = MTP® Male
					-3 = Flat with groove		-7 = Black loose tube with boot	-02 = MTP® Female
					-4 = PCIe® Pin-fin (-10 Data Rate only)		-8 = Black loose tube	-07* = MXC® Internal Plug
								-0A = VITA 66.1/66.4 READY
								-0C = MT38999 Male

PRELIMINARY

ETMO
Mates with:
UEC5, UCC8, OPA

FEATURES

- Dual power mode for interoperability with legacy optical modules
- Extended temp range of -40 °C to +85 °C
- Micro rugged board level connector system with positive latching, weld tabs and loading guides for a secure connection
- Customizable optical end connectors including MT Elite®, MTP Elite®, and low loss MXC®
- Integral heat sink provides optimal cooling for thermal operating conditions
- Sealed and parylene-coated for exposed military, aerospace and submersible applications
- Ruggedized for tin whisker mitigation and fungal resistance; operates in harsh environments including salt fog, blowing sand and dust, jet fuel exposure, altitudes up to 65,000 feet

CLASS 1 LASER PRODUCT
per IEC 60825-1 Ed. 3 (2014)

Applies to all end 2 options except MXC®

Notes:
MT Elite®, MTP Elite®, and MXC® are registered trademarks of US Conncet Ltd.

PCI-SIG®, PCI Express® and the PCIe® design marks are registered trademarks and/or service marks of PCI-SIG.

All FireFly™ designs, specifications and components are preliminary and subject to change without notice.

Some lengths, styles and options are non-standard, non-returnable.

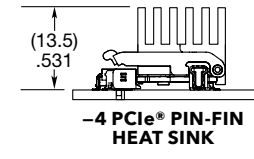
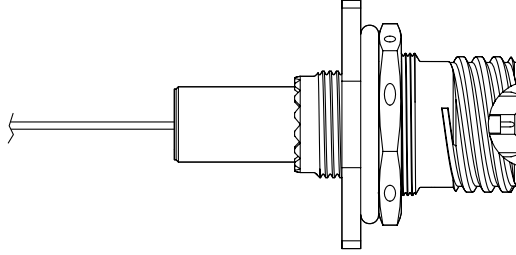
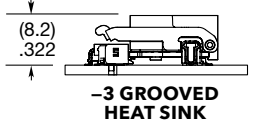
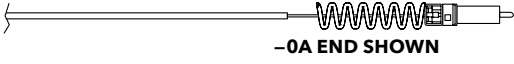
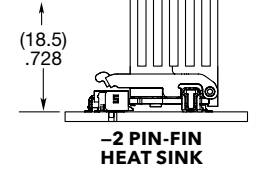
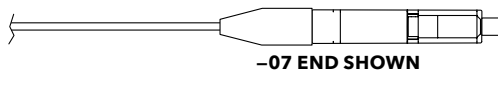
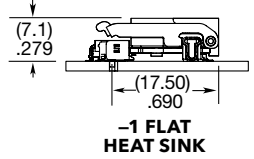
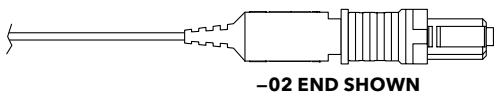
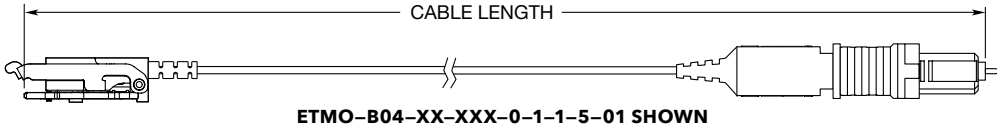

***CLASS 3R LASER PRODUCT**
Laser Radiation. Avoid Direct Eye Exposure.



Applies to MXC® end option only.

View complete specifications at: samtec.com?ETMO

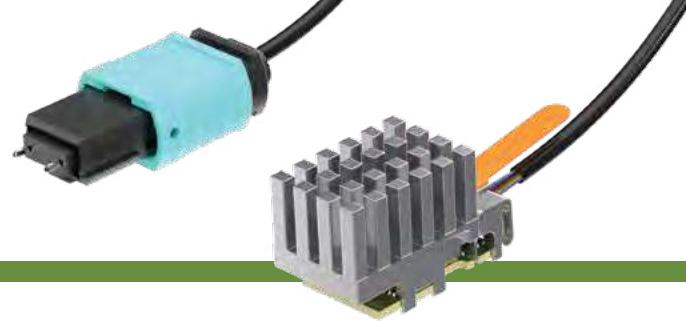

PCIe®-OVER-FIBER FLYOVER®

PCUO	WIDTH	DATA RATE	CABLE LENGTH	0	HEAT SINK	1	FIBER TYPE	END 2 OPTIONS
PCUO Mates with: UEC5, UCC8, OPA	-04 = x4 Lanes -08 = x8 Lanes	-G4 = 4.0 Speed	-"XXX" = Overall Length in Centimeters	0	-1 = Flat -4 = PCIe® Pin-fin	1	-7 = Black loose tube with boot -8 = Black loose tube	(-04 width requires -01 option; -08 width requires -21 option) -01/-21 = MTP® Male

FEATURES

- PCIe® 4.0 x4, scalable to x8 and x16 widths
- Duplex auxiliary signals allow both transparent and non-transparent bridging
- High-performance signal quality with BER better than 1E⁻¹²
- Enables links up to 100 m
- Allows nontraditional FPGA/ASIC end points
- Standard temperature range 0 °C to +70 °C

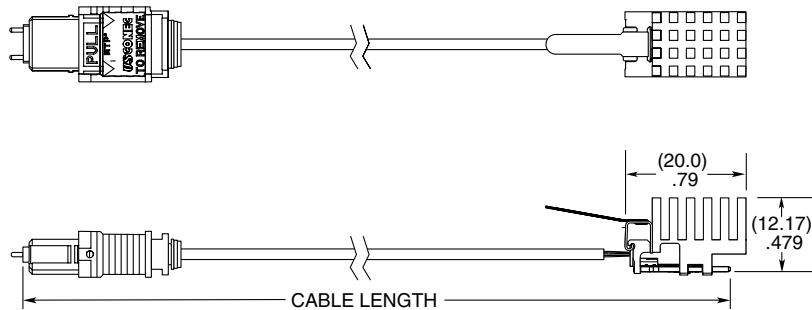

PCUO-04-G4-XXX-0-4-1-8-01 SHOWN

CLASS 1 LASER PRODUCT
per IEC 60825-1 Ed. 3 (2014)

View complete specifications at: samtec.com?PCUO

EXTENDED TEMP PCIe®-OVER-FIBER

PTUO	WIDTH	DATA RATE	CABLE LENGTH	0	HEAT SINK	1	FIBER TYPE	END 2 OPTIONS
PTUO Mates with: UEC5, UCC8, OPA	-04 = x4 Lanes -08 = x8 Lanes	-G3 = 3.0 Speed	-"XXX" = Overall Length in Centimeters	0	-1 = Flat -2 = Pin-fin -3 = Flat with groove -4 = PCIe® Pin-fin	1	-7 = Black loose tube with boot -8 = Black loose tube	(-04 width requires -0X option; -08 width requires -2X option) -01/-21 = MTP® Male -02/-22 = MTP® Female -0A/-2A = VITA 66.1/66.4 Ready -0C/-2C = MT38999 Male

FEATURES

- Extended temperature range from -40 °C to +85 °C
- PCIe® 3.0 x4, scalable to x8 and x16 widths
- Duplex auxiliary signals allow both transparent and non-transparent bridging
- High-performance signal quality with BER better than 1E⁻¹²
- Enables links up to 100 m
- Allows nontraditional FPGA/ASIC end points
- Additional heat sink and end options available
- PCIe® 4.0 version in development

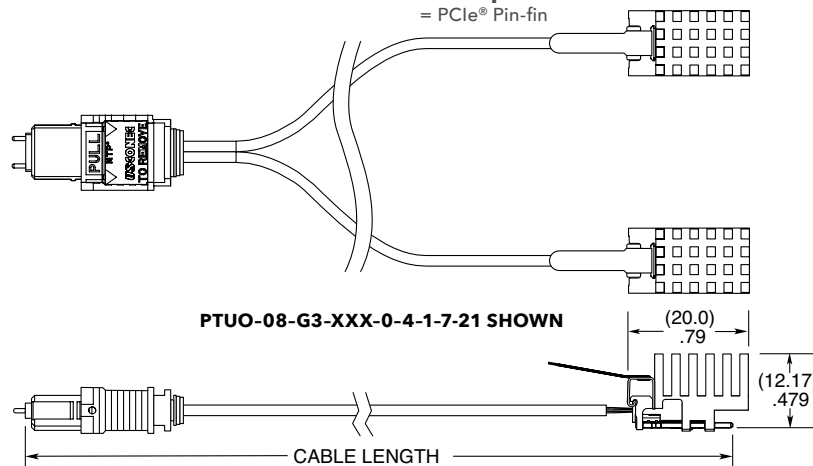

PTUO-08-G3-XXX-0-4-1-7-21 SHOWN

PCI-SIG®, PCI Express® and the PCIe® design marks are registered trademarks and/or service marks of PCI-SIG.

Note:
Some lengths, styles and options are non-standard, non-returnable.

CLASS 1 LASER PRODUCT
per IEC 60825-1 Ed. 3 (2014)

View complete specifications at: samtec.com?PTUO

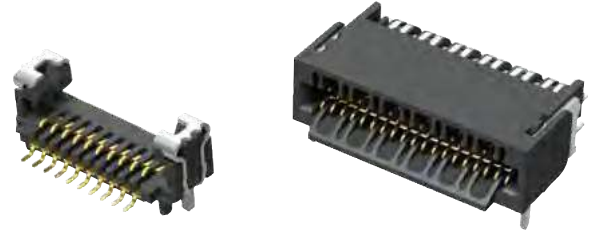

RUGGED MICRO FLYOVER® SOCKET SYSTEM

UEC5	NO. OF POSITIONS	DATA RATE	PLATING OPTION	D	RA	WELD TAB	OPTION	PACKAGING
	-019 (Per Row)	-1 = Up to 16 Gbps -2 = 28 Gbps+	-H = 30 μ" (0.76 μm) Gold on contact, Gold flash on tail (-1 Data Rate only) -H = 30 μ" (0.76 μm) Gold on contact, Matte Tin on tail (-2 Data Rate only)			-1 = Through-hole -2 = Surface Mount (Data Rate -1 only)	Leave blank for -2 Data Rate -A = Alignment Pin (Available with Data Rate -1 only)	Leave blank for Tape & Reel -FR = Full Reel Tape & Reel (must order max. quantity per reel; contact Samtec for quantity breaks)

UEC5

Cable Mates:
ECUE, ECUO,
PCUO, PTUO, PCUE,
ETUO, ETMO

SPECIFICATIONS

Insulator Material:
Black LCP
Contact Material:
BeCu
Plating:
Au or Sn over
50 μ" (1.27 μm) Ni
Operating Temp Range:
-55 °C to +125 °C

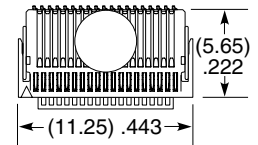
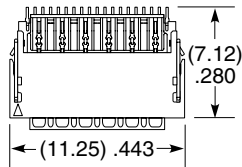

PROCESSING

SMT Lead Coplanarity:
(0.10 mm) .004" max.

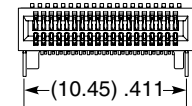
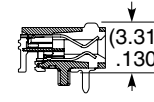
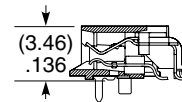
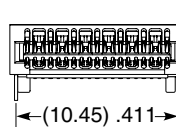

UEC5-019-2-X-D-RA-1

UEC5-019-1-X-D-RA-1-A

Note:
PCB footprints are not interchangeable for -1 and -2 data rate versions.

View complete specifications at: samtec.com?UEC5-1 & samtec.com?UEC5-2

UCC8	NO. OF POSITIONS	1	PLATING OPTION	S	WELD TAB	A	PACKAGING
	-010		-H = 30 μ" (0.76 μm) Gold on contact, Gold flash on tail		-1 = Through-hole		Leave blank for Tape & Reel -FR = Full Reel Tape & Reel (must order max. quantity per reel; contact Samtec for quantity breaks)

UCC8

Cable Mates:
ECUE, ECUO,
PCUO, PTUO, PCUE,
ETUO, ETMO

SPECIFICATIONS

Insulator Material:
Black LCP
Contact Material:
BeCu
Weld Tab:
Copper Alloy
Plating:
Au or Sn over
50 μ" (1.27 μm) Ni
Operating Temp Range:
-55 °C to +125 °C

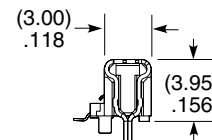
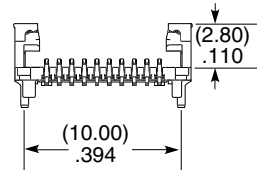
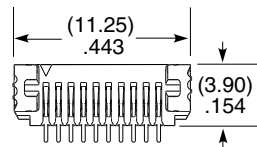

PROCESSING

SMT Lead Coplanarity:
(0.10 mm) .004" max.

Note:
Some sizes, styles and options are non-standard, non-returnable.

View complete specifications at: samtec.com?UCC8



PCI EXPRESS
4.0 SOLUTIONS



PCIe®-OVER-FIBER ADAPTOR CARD

PCOA	DATA RATE	WIDTH	CONFIGURATION
------	-----------	-------	---------------

-G3
= 3.0 Speed
-G4
= 4.0 Speed

-S4
= Single x4
-D4
= Dual x4
-Q4
= Quad x4
-S8
= Single x8
-D8
= Dual x8 or Single x16

-0A
= Transparent Bridge Host
(For non-transparent bridging support, contact Samtec)

FEATURES

- Uses PCUO FireFly™ optical cable for clear signal transmissions with increased reach and cost optimization
- PCIe® x16 edge card connector
- Scalable configurations for cost optimized performance
- Transparent or non-transparent bridging for system flexibility and multi-processor support
- Reconfigurable host or target operation
- Ideal for high-performance and applications requiring robust data transmission

PRELIMINARY

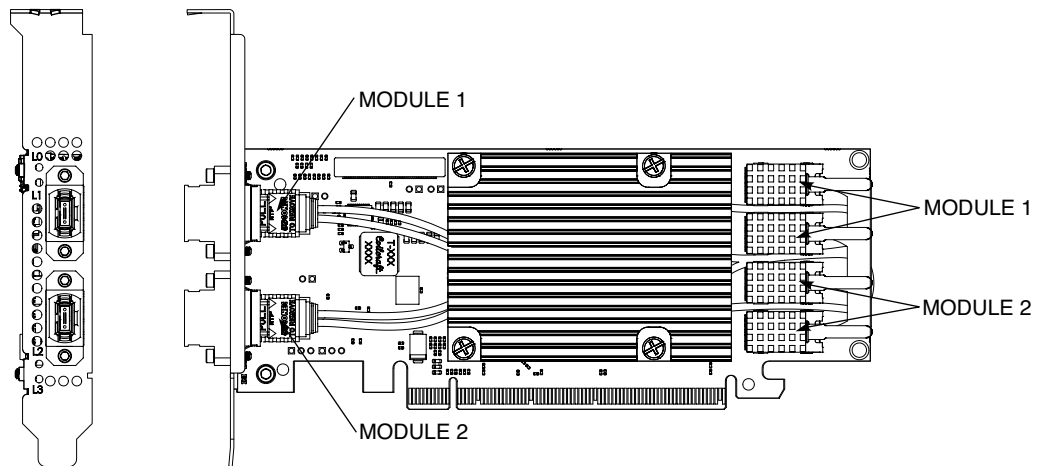

PCOA-G4-D8-0A SHOWN

CLASS 1 LASER PRODUCT
per IEC 60825-1 Ed. 3 (2014)

-G3 Data Rate only (- G4 in testing)

Notes:
Some lengths, styles and options are non-standard, non-returnable.

PCI-SIG®, PCI Express® and the PCIe® design marks are registered trademarks and/or service marks of PCI-SIG.

View complete specifications at: samtec.com?PCOA

OPTICAL PATCH CABLE AND ADAPTOR

FOPC	END 1	END 2	CABLE LENGTH	FIBERS	CONSTRUCTION
	-01 = MTP® Male	-01 = MTP® Male	-003 = 3 Meters	-12, -24	-01 = 3 mm Round Jacket
	-02 = MTP® Female	-02 = MTP® Female	-010 = 10 Meters		
			-100 = 100 Meters (Other lengths available as custom parts)		

OVERALL LENGTH = CABLE LENGTH ±5%

FOPC-01-01-XXX-12-01

FOPC-02-02-XXX-24-01

12 FIBER

24 FIBER

SPECIFICATIONS

Compliant Specifications:
TIA-604-5-D (FOCIS 5)
TIA-568-C.3
IEC-61754-7-1

View complete specifications at: samtec.com?FOPC

OPA	PORTS	KEY	FLANGE
	-S = Single	-1 = Opposed	-F = Full
	-D = Double	-2 = Aligned	

-S

-D

SPECIFICATIONS

Compliant Specifications:
TIA-604-5-D (FOCIS 5)
IEC-61754-7

Recommended Panel Thickness:
(1.75 mm) .069"
(The OPA can be installed with any panel thickness but mounting hardware is needed for any thickness that is not (1.75 mm) .069". Contact the Optics Group at FireFly@samtec.com for questions about panel thickness and mounting hardware.)

View complete specifications at: samtec.com?OPA

Notes:
MTP® is a registered trademark of US ConneC Ltd.
Some lengths, styles and options are non-standard, non-returnable



FIREHAWK™ RUGGEDIZED OPTICAL TRANSCEIVERS

FEATURES & BENEFITS

- Chip Scale Package (CSP) with the industry's smallest footprint and lowest profile, weighing less than 0.4 grams
- RVCON® optical cables are removable and replaceable for repair or reconfiguration
- FireHawk™ for Mil/Aero with an integrated microcontroller to automate key functions (CSPO)
- FireHawk™ for Space designed to withstand the impacts of radiation without the need for a microcontroller (CSSO)
- Extreme performance with up to 40 Gbps transfer rate (10G x 4)
- Rugged BGA board attach withstands high shock and vibration with the shortest possible thermal path
- Development Kit available, visit samtec.com/kits

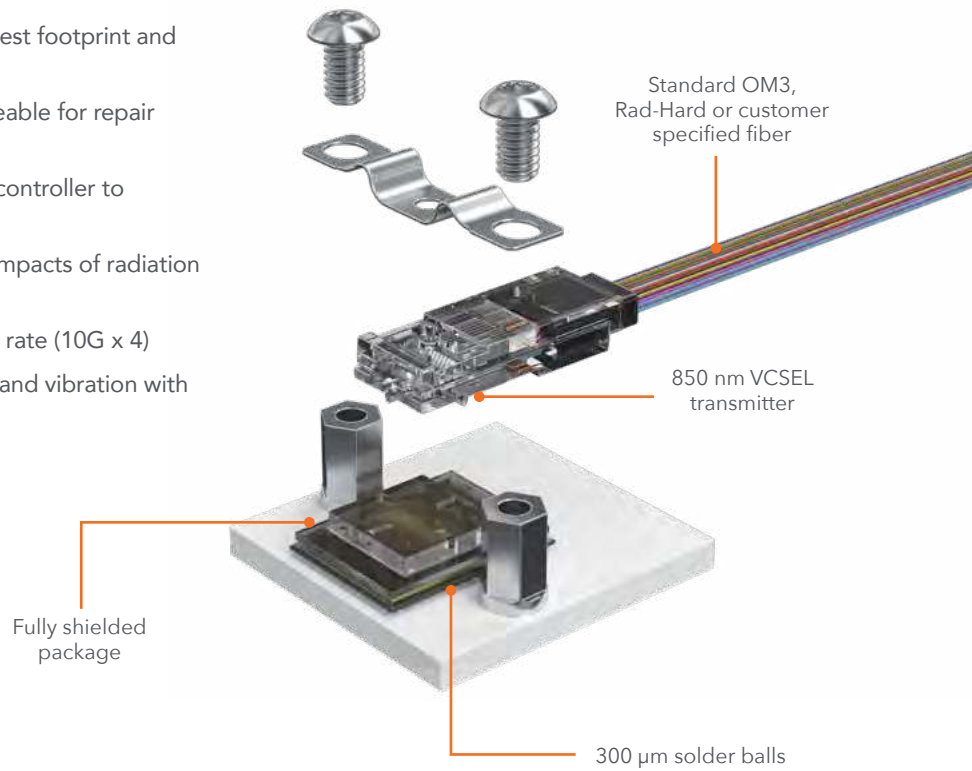
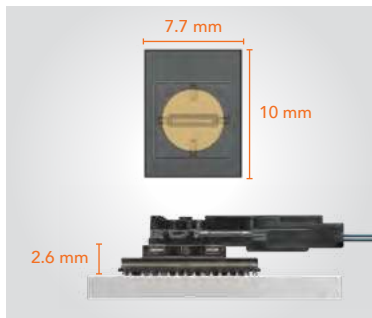

FIREHAWK™ RVCON® OPTICAL CABLES

RVCN	END 1 OPTION	END 2 OPTION	FIBER TYPE	CABLE CONFIGURATION	CABLE LENGTH
	-1 = 1 RVCON®	-3 = MT Ferrule	-MM = Multi Mode	-2 = Jacketed Ribbon	-XXXX = Total length in millimeters (mm)



- RVCON® connector transfers the vertical output from the transceiver into optical fibers
- Attaches to the CSP after surface mount processing of the PCB board
- Designed for harsh environments and wide temperature ranges
- Design flexibility: ribbon, tubed and breakout fiber options; MUX/DMUX input and output configurations; CSP to multiple ends; single input to multiple CSPs (1:1, 1:2, 1:3)
- Variety of end 2 options including standard and mil/aero connectors, pins and shells

FIREHAWK™ CSPO FOR MIL/AERO APPLICATIONS

CSPO	WIDTH	DATA RATE	ENVIRONMENT TYPE	0	FIRMWARE	1	BALL TYPE
	-B04 = 4 channel, bidirectional	-10G = 10 Gbps	-3 = Military		-1 = Standard		-2 = Tin Lead

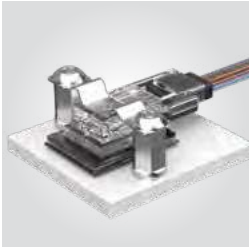

- Integrated microcontroller automates key functions: calibration, temperature compensation, register configuration, converts analog BIT into calibrated digital
- 10G x 4 data rate (10 Mbps to 10 Gbps per channel)
- -40 °C to +85 °C temperature range (+95 °C available)
- 3.3 V supply voltage; 1.2 W (total power 4 Tx and 4 Rx active)
- Roadmap: 25G x 4 system (up to 25 Gbps per channel) in the same 10G connector footprint

FIREHAWK™ CSSO FOR SPACE APPLICATIONS

CSSO	WIDTH	DATA RATE	ENVIRONMENT TYPE	0	0	1	BALL TYPE
	-B04 = 4 channel, bidirectional	-10G = 10 Gbps	-4 = Space				-2 = Tin Lead

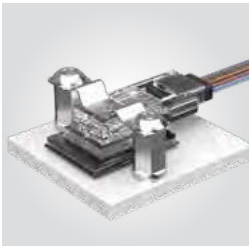

- 0.4 grams total weight for optimal SWaP (Size, Weight and Power)
- No microcontroller needed
- Radiation tolerant circuitry
- Optical cabling reduces weight and size for longer connections in satellites
- Module management, controls and diagnostics through a Serial Peripheral Interface (SPI)
- Robust performing ASIC for use in radiation environments

HALO™ NEXT GEN OPTICAL

- Capable of up to 112 Gbps PAM4 per lane
- Up to 16 channels (8 channel bidirectional)
- Low 6.5 mm profile with a 2-piece contact system
- Designed to withstand high shock and vibration
- Features a low center of gravity for a stable connection to the board
- Optically pluggable for easy replacement and increased uptime

HALO™

PAM4
112
G b p s

PRELIMINARY



HALO	ENVIRONMENTAL	WIDTH	DATA RATE	1	1
	-C	-B08 = 8 Tx + 8 Rx	-3 = 56 Gbps PAM4		

OPTICS EVALUATION & DEVELOPMENT KITS

From concept and prototype to development and production, Samtec-designed and Partner-designed kits and boards featuring FireFly™ Micro Flyover System™ simplify design and reduce time to market. For more information, please visit samtec.com/kits or contact KitsAndBoards@samtec.com.

28 Gbps FireFly™ Evaluation Kit

Samtec's 28 Gbps FireFly™ Evaluation Kit offers an easy-to-use platform for testing and real-time evaluation of the FireFly™ Micro Flyover System™. The kit supports copper or optical FireFly™ in x4 or x12 configurations. (Samtec P/N: REF-209623-01)

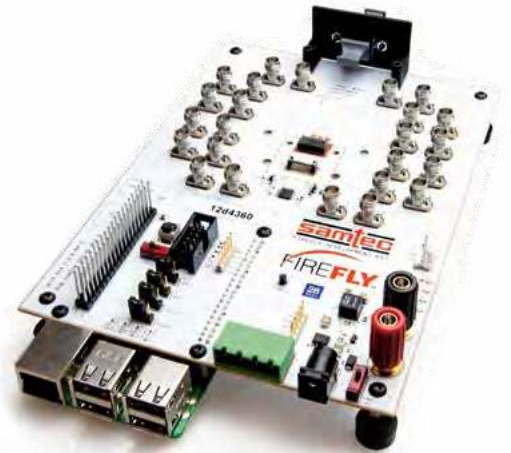

14 Gbps FireFly™ FMC Development Kit

Samtec's 14 Gbps FireFly™ FMC Development Kit is VITA 57.1 electrically compliant and provides up to 140 Gbps full-duplex bandwidth over 10 channels from an FPGA to an industry-standard multi-mode fiber optic cable. (Samtec P/N: REF-193429-01)



25/28 Gbps FireFly™ FMC+ Development Kit

Samtec's 25/28 Gbps FireFly™ FMC+ Module is VITA 57.4 electrically compliant and provides up to 400/448 Gbps full-duplex bandwidth over 16 channels from an FPGA to an industry-standard multi-mode fiber optic cable. (Samtec P/N: REF-200772-XXX-XX-01)



10 Gbps FireHawk™ Evaluation Kits

Samtec's FireHawk™ Evaluation Kits offer real-time evaluation of FireHawk™ rugged optical transceivers in a lab or benchtop setting. Rated to 10 Gbps per lane in a x4 configuration, the transceivers combine extreme density with extreme performance to meet the harshest environments.



KIT NAME	SAMTEC KIT PN	ULTRA COMMUNICATIONS KIT PN	APPLICATIONS
FireHawk™ CSSO 10 Gbps Evaluation Kit	REF-230448-01	X80S-0103-EVK-003	Space
FireHawk™ CSPO 10 Gbps Evaluation Kit	REF-230449-01	X80SC-0102-EVK-003	Mil/Aero

RF/PRECISION RF

CABLE ASSEMBLIES • CONNECTORS • ORIGINAL SOLUTIONS • TECHNICAL SUPPORT

CABLE ASSEMBLIES

144-167

Precision RF 50 Ω
(18 GHz to 110 GHz)

168-181

Standard RF 50 Ω & 75 Ω
(Sub-6 GHz & 12G-SDI)



CABLE CONNECTORS

148-161

Precision RF 50 Ω
(18 GHz to 110 GHz)

170-180

Standard RF 50 Ω & 75 Ω
(Sub-6 GHz & 12G-SDI)



BOARD CONNECTORS

148-161

Precision RF 50 Ω
(18 GHz to 110 GHz)

170-181

Standard RF 50 Ω & 75 Ω
(Sub-6 GHz & 12G-SDI)



ADAPTORS

162-163

Precision RF 50 Ω
(In-Series & Between-Series)



ORIGINAL RF SOLUTIONS

147

Precision RF

181

Low Frequency



Magnum RF™ Solutions for Ganged Cable-to-Board or Board-to-Board Applications	156-157
Bulls Eye® Solutions for 40 GHz, 50 GHz, 70 GHz & 90 GHz	164-166
Flexible Waveguide Technology for Frequencies up to 90 GHz (E-band)	167
Customs & Tech Support	182

COMPLETE RF INTERCONNECT SOLUTIONS

PRECISION 50 Ω (18 to 110 GHz) • STANDARD 50 Ω & 75 Ω (SUB-6 GHz & 12G-SDI) • TECH SUPPORT

Samtec offers complete RF interconnect solutions supporting traditional sub-6 GHz frequencies to 110 GHz microwave/mmWave frequencies (sub-Terahertz spectrum). Products include end-to-end RF cable assemblies, board connectors, cable connectors, adaptors and Samtec Original RF solutions.

Technical Support

High-level design and development of advanced interconnect systems, along with industry leading expertise, allows us to offer effective strategies and support for optimizing the entire signal channel.

RF technical support includes launch optimization, simulation and testing. Customization of products, both quick-turn modifications or new designs, is also available.

Applications

- Test and Measurement
- Military, Aerospace, Satellite, Radar
- 5G/6G, Low Latency Wireless Communications
- Automotive, Telematics
- Broadcast & 12G-SDI
- Industrial, Monitoring, Instrumentation

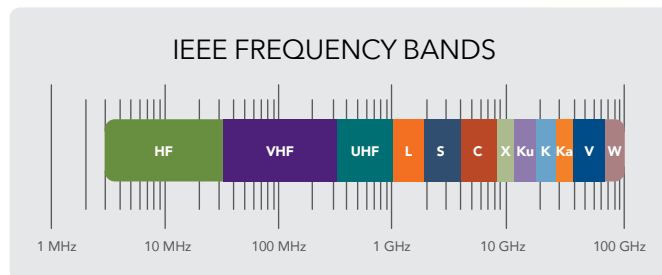

PRECISION RF, 50 Ω

Interface	1.00 mm	1.35 mm	1.85 mm	2.40 mm	2.92 mm	3.50 mm	SSMA	SMA	Ganged SMPM	SMPM	SMP	N Type	TNCA
Frequency	110 GHz	90 GHz	65 GHz	50 GHz	40 GHz	34 GHz	34 GHz	18/26.5 GHz	65 GHz	65 GHz	40 GHz	18 GHz	18 GHz

STANDARD RF, 50 Ω & 75 Ω

Interface	MHF	SMA	MCX	MMCX	TNC	BNC (50 Ω)	SMB (50 & 75 Ω)	Ganged (50 & 75 Ω)	BNC (75 Ω)	HD BNC (75 Ω)	DIN 1.0/2.3 (75 Ω)
Frequency	6 GHz	6 GHz	6 GHz	6 GHz	6 GHz	4 GHz	4 GHz	5 GHz	12 GHz	12 GHz	12 GHz

CABLE ASSEMBLIES

- Precision, high frequency or standard, low frequency
- Assemblies available with the following cable types:
 - Low-loss microwave/millimeter wave from .047 to .277, semi-flexible
 - **Orange Cable!** Phase and insertion loss stable, high-performance cable assemblies optimized for next gen frequency targets
 - RG type (316, 174, 178, 58, 179, 6)
 - 12G-SDI optimized
 - 0.81 mm and 1.13 mm Micro High Frequency (MHF)
- Discrete and ganged solutions
- Cable lengths standard up to 10 meters (> 10 meters as custom RSP)
- Phase matching in pairs down to 1 ps
- Cable management available
- **Mix & Match Solutions for Any Application:** Samtec offers a variety of end options for each product series; this blends application-specific customization with the simplicity and lead-time efficiencies of an off-the-shelf assembly



BOARD CONNECTORS, CABLE CONNECTORS & ADAPTORS

- Precision, high frequency or standard, low frequency solutions
- Board-to-board or cable-to-board applications
- Threaded, bulkhead, push-on or bayonet coupling
- Solderless compression mount: vertical & edge launch
- Soldered: through-hole, surface mount, edge mount or mixed technology
- Balanced connectors for high-volume pick-and-place automation
- 12G-SDI optimized broadcast video solutions (BNC, high-density BNC, DIN 1.0/2.3)
- Cable connectors for use with industry standard cables: offer the flexibility to terminate to an industry-standard cable specified for your application
- Adaptors for 50 Ω precision RF applications: in-series and between-series



Ganged Solutions



Complete Mated Sets



50 Ω , 75 Ω & 12G-SDI Solutions



Precision Interconnects

PRECISION RF

MICROWAVE / MILLIMETER WAVE CABLE ASSEMBLIES & INTERCONNECTS

The Samtec RF product line includes 18 to 110 GHz High Frequency, Precision RF solutions for microwave and mmWave applications, including full cable assemblies, cable connectors and board level interconnects. Our focus is on delivering high-quality RF products that meet precision and performance expectations, blended with industry-leading system-level signal integrity expertise.

Vertical Integration

=

Full System Support

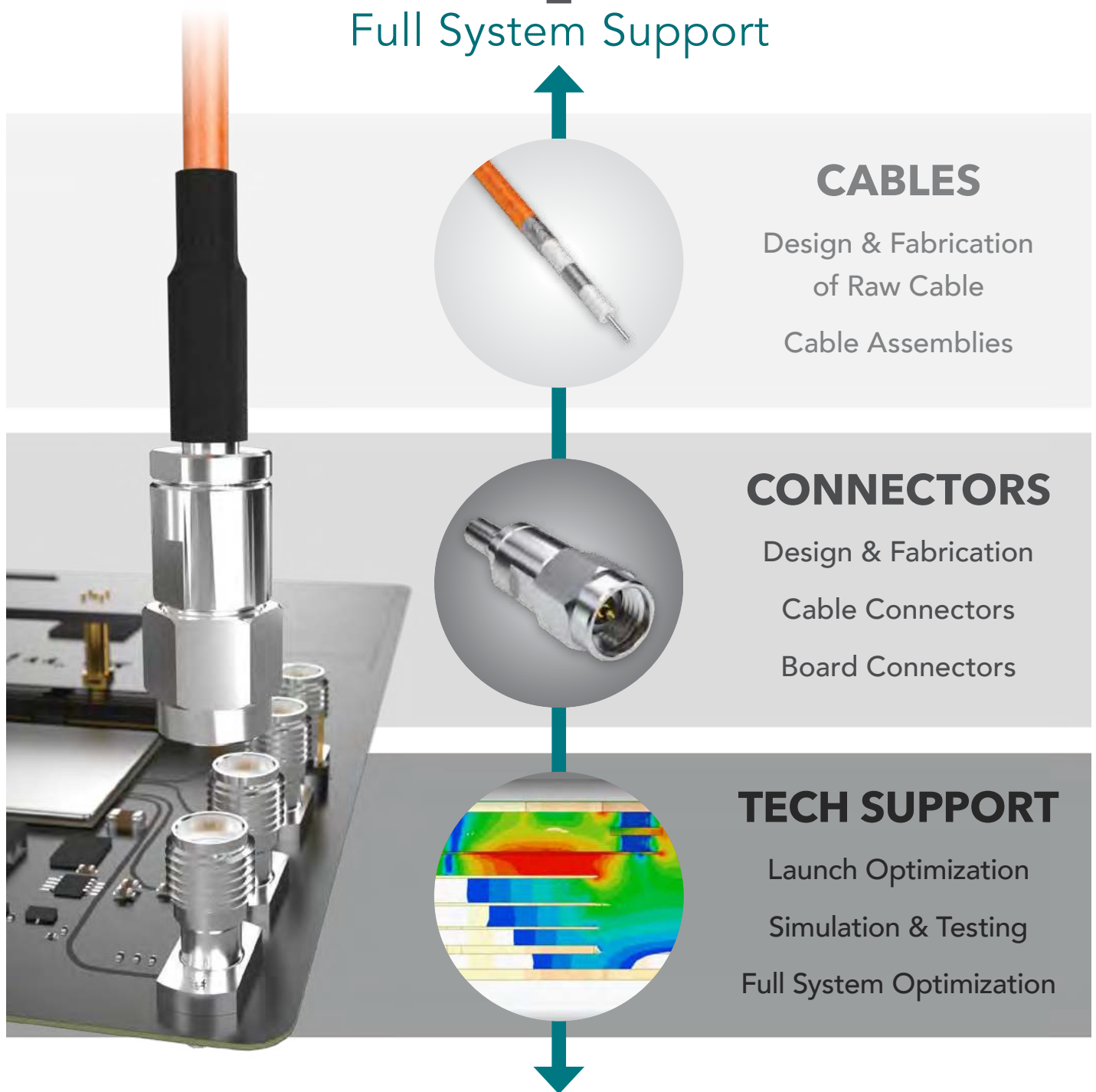

ORANGE IS THE NEW CABLE!



PHASE & INSERTION LOSS STABLE HIGH FREQUENCY CABLE ASSEMBLIES

Samtec's next generation of RF coaxial cable offers improved stability with temperature and flexure over time. The coaxial structure—with an outer jacket colored in distinctive Samtec orange—is designed to meet increased demands placed on the aerospace, defense, datacom, computer/semiconductor and instrumentation markets. Performance is optimized at frequencies that go beyond traditional industry targets to support emerging applications.

LOW-LOSS CABLE CONSTRUCTION (VS. TYPICAL PTFE CABLES)

Series	LL018	LL030	LL043	LL071	LL095
Impedance (Ω)	50				
Max Frequency (GHz)	18	30	43.5	71	95
Outer Dia. (inches)	0.306	0.192	0.143	0.096	0.078
Min Static Bend Radius (to inside of cable) (inches)	1.25	0.375	0.25	0.25	0.125
Velocity of Propagation (%)	77				
Min Shielding Effectiveness (dB)	-90				
Temp Range ($^{\circ}\text{C}$)	-65 $^{\circ}\text{C}$ to +125 $^{\circ}\text{C}$				
Insertion Loss	See Chart Below				

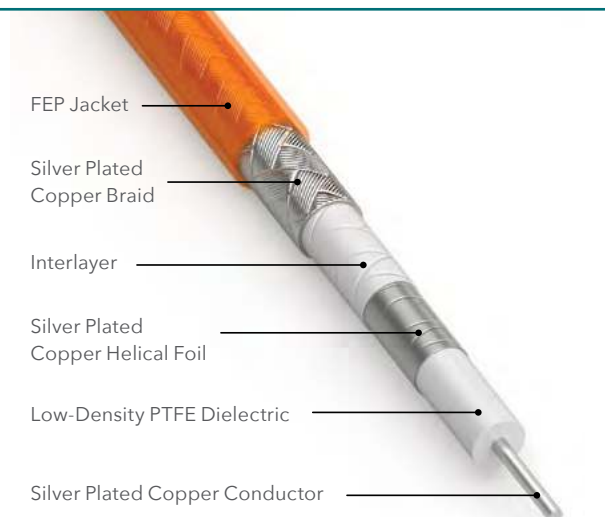

INSERTION LOSS (dB/m)

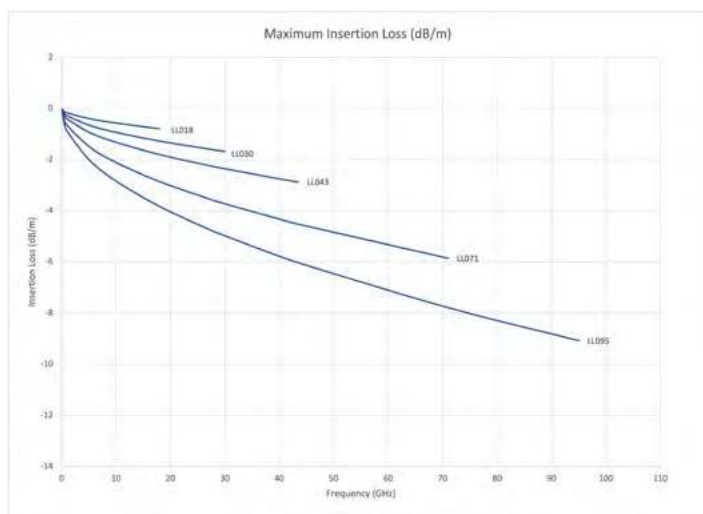

FREQUENCY FOR EMERGING APPLICATIONS

18 GHz, 30 GHz, 43.5 GHz,
71 GHz, 95 GHz

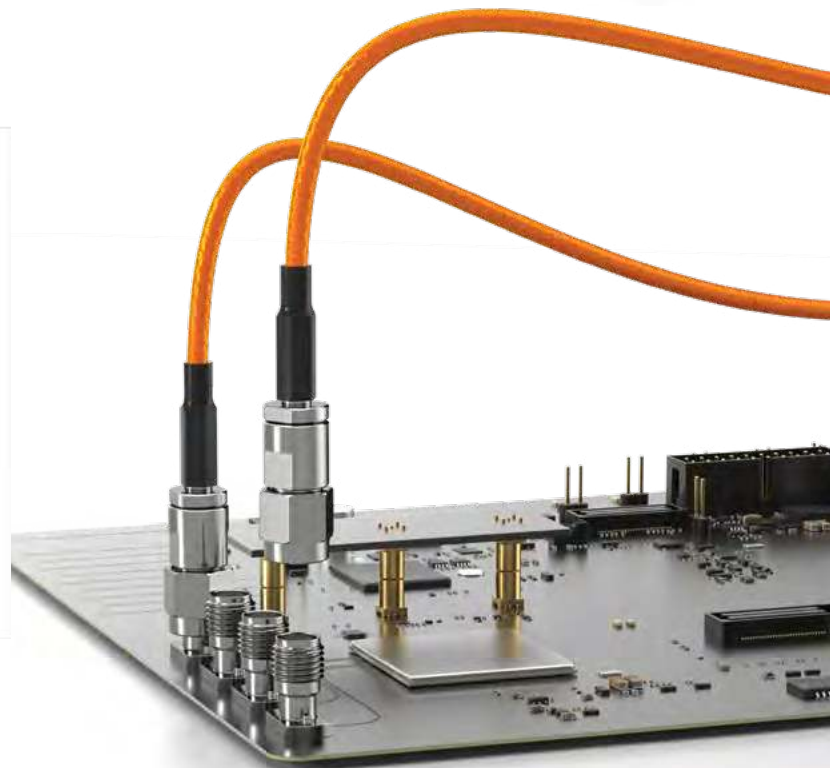

50 Ω μWAVE/mmWAVE CABLE SPECIFICATIONS

STANDARD OFF-THE-SHELF ASSEMBLIES

SERIES	RF047-A, GC47	RF25S	RF40S	RF08S	RF086, GC86	RF23C	RF23S	RF402	RF180	RF280	
TYPE	.047 (29 AWG), low loss flexible	Samtec 25 AWG, flexible	RG 40S, .086, (24 AWG), semi- flexible	.085 (24 AWG), low loss flexible	.086 (23 AWG), low loss flexible	Samtec 23 AWG, flexible, copper shield	Samtec 23 AWG, flexible	RG 402, .141 (19 AWG), semi- flexible	.178 (16 AWG), low loss flexible	.277 (11 AWG), low loss flexible	
ELECTRICAL											
Max. Frequency (GHz)	65	40	20	50	65	50	35	20	27	18	
Max. Insertion Loss (dB/m)	1 GHz	1.21	0.79	0.72	0.69	0.65	0.68	0.72	0.40	0.27	0.17
	26 GHz	7.43	3.80 @ 20 GHz	4.26 @ 20 GHz	4.28	3.90	4.27	3.71 @ 20 GHz	2.30 @ 20 GHz	1.23 @ 18 GHz	0.79 @ 18 GHz
	40 GHz	9.68	–	–	5.59	5.06	5.59	–	–	–	–
	50 GHz	11.14	–	–	6.47	5.81	6.46	–	–	–	–
Propagation Delay (ns/m)	4.76		4.79	4.75	4.20	4.76	4.72	4.79	4.17	4.02	
Velocity of Propagation	70%				80%	70%		70%	80%	83%	
Capacitance (pF/m)	95.00	96.80	104.97	88.20	83.37	97.80	95.45	98.07	82.00		
CONSTRUCTION											
Center Conductor	Material	Solid Silver Plated Copper									
	AWG (mm/in.)	29 (.2870 / .0113)	25 (.4570 / .0180)	24 (.5100 / .0200)		23 (.5740 / .0226)			19 (.9200 / .0362)	16 (1.3000 / .0512)	11 (2.2600 / .0889)
Dielectric	Material	PFA	Solid FEP	PTFE	Solid PTFE	Foam FEP	FEP	Solid FEP	PTFE	PTFE Tape	
	Dia. (mm/in.)	.9220 / .0363	1.4700 / .0578	1.6800 / .0660	1.6300 / .0640	1.6150 / .0636	1.8470 / .0727	1.8470 / .0727	2.9800 / .1170	3.6800 / .1450	6.3500 / .2500
Shield	Material	1) Ag Plated Cu 2) Ag Plated Cu		Tinned Cu	Spiral Strip Ag Plated Cu	1) Ag Plated Cu 2) Ag Plated Cu	1) Ag Plated Cu 2) Cu Tape 3) Ag Plated Cu	1) Ag Plated Cu 2) Ag Plated Cu	Tinned Cu	1) Flat Ag Plated Cu 2) Al Polyester 3) Round Ag Plated Cu	
Outer Braid	Dia. (mm/in.)	1.1700 / .0460	1.8600 / .0735	2.2000 / .0860	2.1300 / .0840	2.1080 / .0830	2.2730 / .0895	2.2480 / .0885	3.5800 / .1410	4.5200 / .1780	7.0400 / .2770
Jacket	Material	FEP		–	FEP			–	FEP		
	Dia. (mm/in.)	1.4200 / .0560	2.0600 / .0810	3.2000 / .1260	2.6400 / .1040	2.5400 / .1000	2.6670 / .1050	2.5900 / .1020	4.5800 / .1803	4.9500 / .1950	7.6200 / .3000
MECHANICAL											
Operating Temp	-65° C to 125° C	-40° C to 200° C	-40° C to 125° C	-65° C to 125° C	-55° C to 125° C	-65° C to 125° C	-40° C to 200° C	-40° C to 150° C	-55° C to 200° C		
Min. Bend Radius	5.00 mm	9.00 mm	6.35 mm	13.20 mm	8.90 mm	3.18 mm	8.89 mm	10.90 mm	24.80 mm	38.10 mm	
Connector Options	1.00 mm, 1.35 mm, 1.85 mm, 2.40 mm, 2.92 mm, SMA, SMP, SMPM, Ganged SMPM (Magnum RF™)	SMA, SMP		2.92 mm, 2.40 mm	1.85 mm, 2.40 mm, 2.92 mm, SMA, SMP, SMPM, Ganged SMPM (Magnum RF™)	2.40 mm, 2.92 mm, SMA, SMP, SMPM	3.50 mm	SMA	SMA, TNCA, N Type	SMA, TNCA, N Type	

For complete specifications, visit samtec.com or contact RFGroup@samtec.com

ORIGINAL SOLUTIONS PRECISION RF

PRECISION ALIGNMENT FEATURES

- Eliminates misalignment that can occur during board assembly
- Ensures repeatable peak connector performance
- Available on 135, 185, 240, 292 & GPPC Series

DIFFERENTIAL PAIR TEST & MEASUREMENT

- Two-port SMPM ganged solution (GPPC Series)
- Solderless compression mount design
- Saves board real estate (2x the spacing savings)
- Cable-to-board or board-to-board

RIGHT-ANGLE, LOW PROFILE, GANGED SMPM

- Extremely low profile, high-density, right-angle connector (GPPC Series, -RA-SM option)
- Belly-to-belly, surface mount PCB connection for maximum density
- Body height: 3.94 mm (.155")

COUNTERWEIGHT SOLUTIONS

- Enables efficient board assembly (eliminates hand soldering)
- Balanced for automated, high-volume pick-and-place automation
- Edge mount SMA (26.5 GHz) or 2.92 mm (40 GHz)

ANALOG OVER ARRAY™ CONNECTORS

- Enhanced open-pin-field arrays simultaneously run analog, digital, and power signals
- Reference designs and evaluation kits
- Industry-leading crosstalk and return loss performance

DC TO
90
GHz

DC TO
65
GHz

DC TO
65
GHz

DC TO
40
GHz

DC TO
15
GHz



Precision Alignment Features

SERIES	135/185/240/292/GPPC	GPPC (-CMM)	GPPC (-RA-SM)	RSP (SMA/2.92 mm)	ANALOG OVER ARRAY™
Application	Precision Alignment	Differential Pair Testing	Extremely Low Profile	Balanced Edge Mount	Analog, Digital & Power
URL	samtec.com/alignment	samtec.com?GPPC	samtec.com?GPPC	Contact: RFGroup@samtec.com	samtec.com/AOA

PRODUCT FAMILY	BULLS EYE®	FLEXIBLE WAVEGUIDE	VNX+	MAGNUM RF™
URL	samtec.com/BullsEye	samtec.com/Waveguide	samtec.com/VNX-plus	samtec.com/magnumRF

1.00 mm TO 110 GHz

1.00 mm Cable Assemblies RF047-A



SERIES	END 1 CONNECTOR	END 2 CONNECTOR	OVERALL LENGTH
RF047-A = (1.2 mm) .047" overshield DIA 29 AWG millimeter wave cable	-10BJ = 1.00 mm Bulkhead Straight Jack -10SP = 1.00 mm Straight Plug		-“XXXX” = Overall Length in millimeters -0100 (100 mm) 3.94" minimum

VSWR

1.40 max. (DC to 90 GHz)
1.50 max. (90 GHz to 110 GHz)

ALSO AVAILABLE

1.35 mm, 1.85 mm, 2.40 mm, 2.92 mm,
SMPM, SMP, SMA = RF047-A

1.00 mm Cable Connectors PRF10



CONNECTORS FOR INDUSTRY STANDARD CABLES	
PRF10-J-C-VP-047D-SS	.047 Semi-Rigid
PRF10-P-C-VP-047D-SS	.047 Semi-Rigid

For a complete list of 1.00 mm cable connectors, visit www.samtec.com?PRF10

J-C = Cable Jack

P-C = Cable Plug

VP = Plating (75 μ" Gold center contact, passivated outer contact)

SS = Straight, Solder Clamp

INTERFACE STANDARD

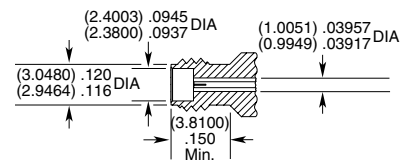
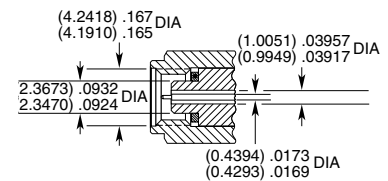

1.35 mm TO 90 GHz

1.35 mm Cable Assemblies RF047-A



SERIES	END 1 CONNECTOR	END 2 CONNECTOR	OVERALL LENGTH
RF047-A = (1.2 mm) .047" overshield DIA 29 AWG millimeter wave cable	-13BJ = 1.35 mm Bulkhead Straight Jack -13SP = 1.35 mm Straight Plug		-“XXXX” = Overall Length in millimeters -0100 (100 mm) 3.94" minimum

ALSO AVAILABLE

1.00 mm, 1.85 mm, 2.40 mm, 2.92 mm,
SMPM, SMP, SMA = RF047-A

VSWR

RF047-A: 1.40 max.

1.35 mm Board Connectors 135

Cable Mates:
RF047-A



135	GENDER	TYPE	PLATING	ORIENTATION	TERMINATION	OPTION	PACKAGING
	-J = Jack	-P = PCB Mount	-VP = 50 μ" (1.27 μm) Gold center contact, Passivated outer contact	-ST = Straight	-CM = Compression Mount Stripline -CMM = Compression Mount Microstrip	-1 = Without screws -2 = With screws	Leave blank for individually bagged. -B = Bulk packaged

-CMM

-CM

1.35 mm Cable Connectors PRF13



CONNECTORS FOR INDUSTRY STANDARD CABLES	
PRF13-P-C-VP-047A-SS	Temp-Flex 1000671047
PRF13-J-C-VP-047A-BS	Temp-Flex 1000671047

For a complete list of 1.35 mm cable connectors, visit www.samtec.com?PRF13
P-C = Cable Plug
J-C = Cable Jack
VP = Plating (75 μ" Gold center contact, passivated outer contact)
SS = Straight, Solder Clamp
BS = Bulkhead, Solder Clamp

INTERFACE STANDARD

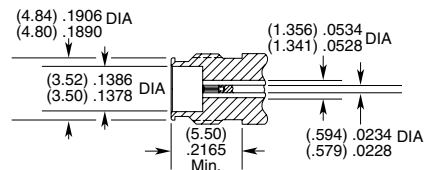
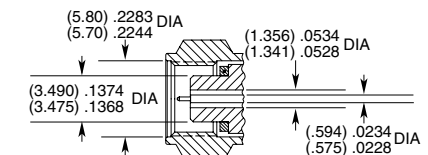

1.85 mm TO 65 GHz

1.85 mm Cable Assemblies

RF047-A, RF086



VSWR

RF047-A: 1.40 max.
RF086: 1.40 max.

SERIES	END 1 CONNECTOR	END 2 CONNECTOR	OVERALL LENGTH
--------	-----------------	-----------------	----------------

RF047-A
= (1.2 mm) .047" overshield DIA 29 AWG millimeter wave cable

RF086
= (2.18 mm) .086" overshield DIA 23 AWG millimeter wave cable

-18SJ
= 1.85 mm Straight Jack

-18SP
= 1.85 mm Straight Plug

-"XXXX"
= Overall Length in millimeters

-0100 (100 mm) 3.94" minimum

ALSO AVAILABLE

1.00 mm, 1.35 mm, 2.40 mm,
2.92 mm, SMPM, SMP, SMA = RF047-A

2.40 mm, 2.92 mm, SMPM, SMP, SMA = RF086

1.85 mm Board Connectors

185

Cable Mates:
RF047-A, RF086



185	GENDER	TYPE	PLATING	ORIENTATION	TERMINATION	OPTION	PACKAGING
-----	--------	------	---------	-------------	-------------	--------	-----------

-J
= Jack

-P
= PCB Mount

-EP
= 50 μ" (1.27 μm) Gold center contact, Passivated outer contact

-ST
= Straight

-CM
= Compression Mount Stripline

-CMM
= Compression Mount Microstrip

-1
= Without Screws (-CM & -CMM only)

-2
= With Screws (-CM & -CMM only)

Leave blank for individually bagged.

-B
= Bulk packaged

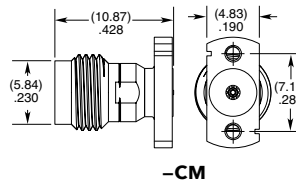
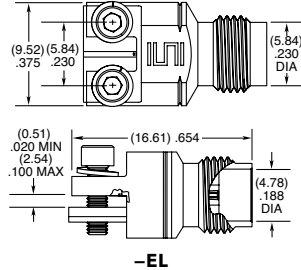

1.85 mm Cable Connectors

PRF18



CONNECTORS FOR INDUSTRY STANDARD CABLES	
PRF18-J-C-EP-085-BS	Harbour SS405
PRF18-P-C-EP-085-SS	Harbour SS405
PRF18-P-C-EE-085-SD	Harbour SS405
PRF18-J-C-EP-086-SS	Temp-Flex 1001935086
PRF18-J-C-EP-047A-SS	Temp-Flex 1000671047
PRF18-P-C-EP-047A-SS	Temp-Flex 1000671047
PRF18-J-C-EP-047D-SS	.047 Semi-Rigid
PRF18-P-C-EP-047D-SS	.047 Semi-Rigid
PRF18-P-C-EE-047D-SD	.047 Semi-Rigid
PRF18-P-C-EE-047H-SD	EZ-47-LA Semi-Rigid
PRF18-P-C-EP-070-SD	EZ-70-LA Semi-Rigid
PRF18-J-C-EE-405-SD	RG 405 Semi-Rigid
PRF18-P-C-EE-405-SD	RG 405 Semi-Rigid
PRF18-P-C-EP-086E-SS	Dynawave DF165

For a complete list of 1.85 mm cable connectors, visit www.samtec.com?PRF18

INTERFACE STANDARD

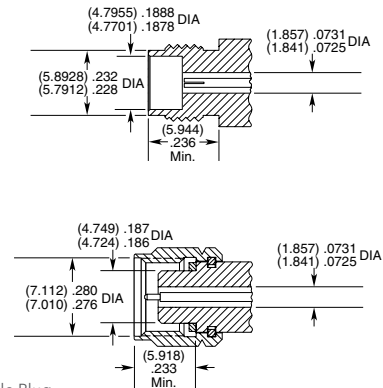

P-C = Cable Plug
J-C = Cable Jack
EE = Plating (50 μ" gold center contact, & outer contact)
EP = Plating (50 μ" gold center contact, passivated outer contact)
SS = Straight, Solder Clamp
SD = Straight, Direct Solder
BS = Bulkhead, Solder Clamp

2.40 mm TO 50 GHz

2.40 mm Cable Assemblies

RF047-A, RF085, RF086, RF23C



VSWR

RF047-A: 1.35 max.
RF086: 1.40 max.
RF085: 1.40 max.
RF23C: 1.40 max.

SERIES

RF047-A

= (1.2 mm) .047" overshield DIA 29 AWG millimeter wave cable

RF086

= (2.18 mm) .086" overshield DIA 23 AWG millimeter wave cable

RF085

= (2.16 mm) .085" overshield DIA 24 AWG millimeter wave cable

RF23C

= MWC-2350CU-01 millimeter wave cable with copper foil shield

END 1 CONNECTOR

-24SJ

= 2.40 mm Straight Jack

-24SP

= 2.40 mm Straight Plug

END 2 CONNECTOR

OVERALL LENGTH

-“XXXX”

= Overall Length in millimeters

-0100 (100 mm)
 3.94" minimum
 (RF047-A, RF085, RF086)

-0152 (152 mm)
 5.984" minimum
 (RF23C)

ALSO AVAILABLE

1.00 mm, 1.35 mm, 1.85 mm,
 2.92 mm, SMPM, SMP, SMA = RF047-A
 1.85 mm, 2.92 mm, SMPM, SMP, SMA = RF086
 2.92 mm = RF085
 2.92 mm, SMPM, SMP, SMA = RF23C

2.40 mm Board Connectors

240

Cable Mates:
 RF047-A, RF086, RF085, RF23C



240 - GENDER - TYPE - PLATING - ORIENTATION - TERMINATION - OPTION - PACKAGING

-J

= Jack

-P

= PCB Mount

-EP

= 50 μ" (1.27 μm) Gold center contact, Passivated outer contact

-ST

= Straight

-CM

= Compression Mount Stripline

-CMM

= Compression Mount Microstrip

-EL

= Edge Launch

-1

= Without Screws (-CM & -CMM only)

-2

= With Screws (-CM & -CMM only)

-01

= .040" to .100" PCB thickness (-EL only)

Leave blank for tray packaging

-B
 = Individually bagged

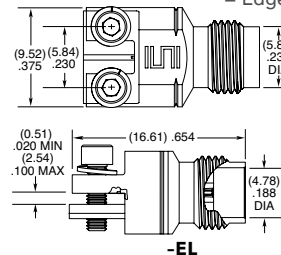
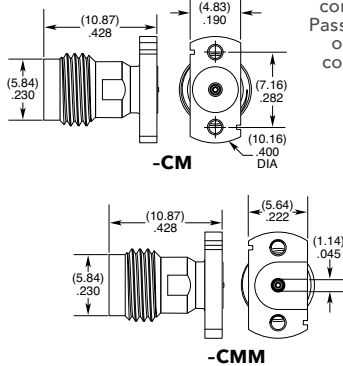

2.40 mm Cable Connectors

PRF24



CONNECTORS FOR INDUSTRY STANDARD CABLES

PRF24-J-C-EP-085-SS	Harbour SS405
PRF24-J-C-EP-405-BS	RG 405
PRF24-P-C-EE-085-SS	Harbour SS405
PRF24-P-C-EP-120A-SS	Semflex HP120
PRF24-J-C-EP-160-SS	Semflex HP160
PRF24-P-C-EP-160-SS	Semflex HP160
PRF24-J-C-EP-140B-SS	IW 1401
PRF24-P-C-EP-140B-SS	IW 1401
PRF24-J-C-EP-150B-SS	IW 1501
PRF24-J-C-EP-150-SS	Dynawave DF150
PRR24-J-C-EP-086-SS	Temp-Flex 1001935086
PRF24-P-C-EP-086-SS	Temp-Flex 1001935086

For a complete list of 2.40 mm cable connectors, visit www.samtec.com?PRF24

P-C = Cable Plug

J-C = Cable Jack

EE = Plating (50 μ" gold center contact & outer contact)

EP = Plating (50 μ" gold center contact, passivated outer contact)

SS = Straight, Solder Clamp

SD = Straight, Direct Solder

BS = Bulkhead, Solder Clamp

INTERFACE STANDARD

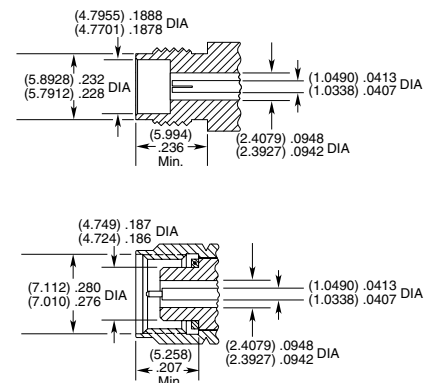

2.92 mm TO 40 GHz

2.92 mm Cable Assemblies

RF047-A, RF086, RF085, RF23C



VSWR

RF047-A: 1.35 max.
RF086: 1.40 max.
RF085: 1.40 max.
RF23C: 1.40 max.

SERIES	END 1 CONNECTOR	END 2 CONNECTOR	OVERALL LENGTH
RF047-A = (1.2 mm) .047" overshield DIA 29 AWG millimeter wave cable	-92SJ = 2.92 mm Straight Jack		-"XXXX" = Overall Length in millimeters -0100 (100 mm) 3.94" minimum (RF047-A, RF085, RF086) -0152 (152 mm) 5.984" minimum (RF23C)
RF086 = (2.18 mm) .086" overshield DIA 23 AWG millimeter wave cable	-92SP = 2.92 mm Straight Plug		
RF085 = (2.16 mm) .085" overshield DIA 24 AWG millimeter wave cable			
RF23C = MWC-2350CU-01 millimeter wave cable with copper foil shield			
ALSO AVAILABLE			
1.00 mm, 1.35 mm, 1.85 mm, 2.40 mm, SMPM, SMP, SMA = RF047-A			
1.85 mm, 2.40 mm, SMPM, SMP, SMA = RF086			
2.40 mm = RF085			
2.40 mm, SMPM, SMP, SMA = RF23C			

2.92 mm Board Connectors

292

Cable Mates:
 RF047-A, RF085,
 RF086, RF23C



292	GENDER	TYPE	PLATING	ORIENTATION	TERMINATION	OPTION	PACKAGING
	-J = Jack	-P = PCB Mount	-EP = 50 μ" (1.27 μm) Gold center contact, Passivated outer contact	-ST = Straight	-CM = Compression Mount Stripline -CMM = Compression Mount Microstrip	-1 = Without Screws (-CM & -CMM only) -2 = With Screws (-CM & -CMM only) -01 = .040" to .100" PCB thickness (-EL only)	Leave blank for individually bagged. -B = Bulk packaged
					-EL = Edge Launch		

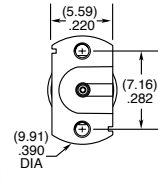
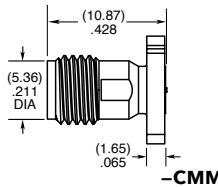
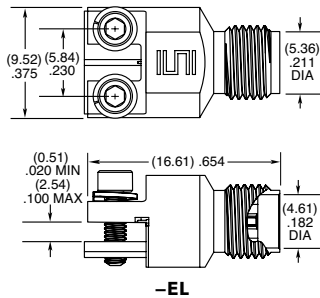

2.92 mm Cable Connectors

PRF92



CONNECTORS FOR INDUSTRY STANDARD CABLES	
PRF92-P-C-EE-405-SD	RG 405 Semi-Rigid
PRF92-P-C-EE-085A-SD	.085 Semi-Rigid
PRF92-P-C-EP-160-SS	Semflex HP160
PRF92-P-C-EP-150B-SS	IW 1501
PRF92-P-C-EP-142-SS	Harbour LL142
PRF92-J-C-EP-085-SS	Harbour SS405
PRF92-J-C-EP-085-BS	Harbour SS405
PRF92-P-C-EP-085-SS	Harbour SS405
PRF92-P-C-EE-402-SD	RG 402
PRF92-P-C-EP-190-SS	Semflex HP190
PRF92-J-C-EP-160-SS	Semflex HP160
PRF92-P-C-EP-120A-SS	Semflex HP120
PRF92-P-C-EP-140-SS	Dynawave DF140
PRF92-P-C-EP-047D-SS	.047 Semi-Rigid
PRF92-J-C-EP-047D-SS	.047 Semi-Rigid
PRF92-P-C-EP-150-SS	Dynawave DF150
PRF92-P-C-EE-118-SD	Haverhill HC35004
PRF92-J-C-EP-402-SS	RG 402
PRF92-J-C-EP-047D-4S	.047 Semi-Rigid
PRF92-P-C-EP-086-SS	Temp-Flex 1001935086
PRF92-P-C-EP-200-SS	Times Max Gain 200

For a complete list of 2.92 mm cable connectors, visit www.samtec.com?PRF92

INTERFACE STANDARD

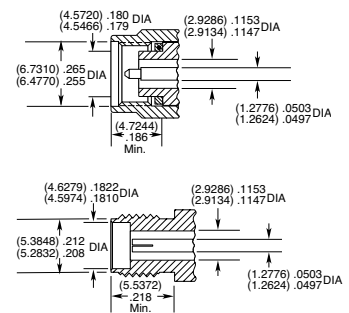

P-C = Cable Plug
 J-C = Cable Jack
 EE = Plating (50 μ" Gold center contact & outer contact)
 EP = Plating (50 μ" Gold center contact, passivated outer contact)
 SS = Straight, Solder Clamp
 SD = Straight, Direct Solder
 BS = Bulkhead, Solder Clamp
 4S = 4-hole flange, Solder Clamp

3.50 mm TO 34 GHz

3.50 mm Cable Assemblies RF235



VSWR

RF235: 1.30 max

SERIES

RF235
= MWC-2350-01 microwave cable with 23 AWG solid FEP Dielectric

END 1 CONNECTOR

-35SJP
= 3.50 mm Straight Jack

-35SPP
= 3.50 mm Straight Plug

END 2 CONNECTOR

OVERALL LENGTH

-"XXXX"
= Overall Length in millimeters
-0100 (100 mm) 3.94" min.

3.50 mm Cable Connectors PRF35



CONNECTORS FOR INDUSTRY STANDARD CABLES

PRF35-P-C-EP-405-SS	RG 405, Semi-Rigid
PRF35-J-C-EP-402-SS	RG 402, .141, Semi-Rigid
PRF35-J-C-EP-402-BS	RG 402, .141, Semi-Rigid
PRF35-P-C-EP-402-SS	RG 402, .141, Semi-Rigid
PRF35-P-C-EP-120A-SS	Semflex HP120
PRF35-J-C-EP-160-SS	Semflex HP160
PRF35-P-C-EP-160-SS	Semflex HP160
PRF35-P-C-EP-210A-SS	Micro-Coax UFA210A

For a complete list of 3.50 mm cable connectors, visit www.samtec.com?PRF35

P-C = Cable Plug

J-C = Cable Jack

EP = Plating (50 μ" Gold center contact, passivated outer contact)

SS = Straight, Solder Clamp

BS = Bulkhead, Solder Clamp

INTERFACE STANDARD

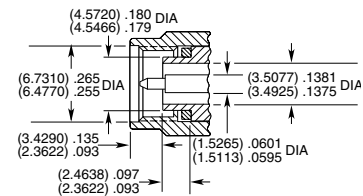
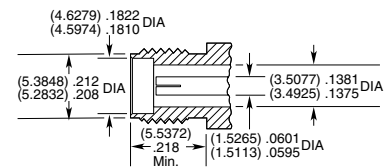

SSMA TO 34 GHz

SSMA Cable Connectors PRFS1



CONNECTORS FOR INDUSTRY STANDARD CABLES

PRFS1-J-C-EE-405-BD	RG 405, Semi-Rigid
PRFS1-P-C-EE-405-SD	RG 405, Semi-Rigid
PRFS1-P-C-EP-141A-SS	Harbour SS402

For a complete list of SSMA cable connectors, visit www.samtec.com?PRFS1

INTERFACE STANDARD

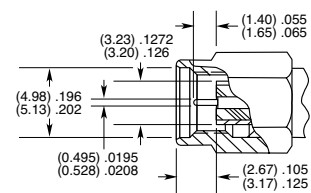
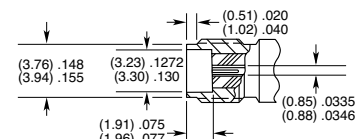

SMA TO 26.5 GHz

SMA Cable Assemblies

RF047-A, RF086, RF23C, RF25S, RF402, RF405, RF180, RF280



VSWR

RF047-A: 1.30 max.
RF086: 1.30 max.
RF23C: 1.30 max.
RF180: 1.35 max.
RF280: 1.35 max.

Additional connector options available. Contact RFGroup@samtec.com

SERIES	END 1 CONNECTOR	END 2 CONNECTOR	OVERALL LENGTH
RF047-A = (1.2 mm) .047" overshield DIA 29 AWG millimeter wave cable	-01SP1* = SMA Straight Plug		-“XXXX” = Overall Length in millimeters
RF086 = (2.18 mm) .086" overshield DIA 23 AWG millimeter wave cable	-01RP1* = SMA Right-angle Plug (RF047-A, RF086, RF23C & RF25S not available)		-0100 (100 mm) 3.94" minimum (RF047-A, RF086, RF25S, RF402, & RF405)
RF23C = MCW-2350CU-01 millimeter wave cable with copper foil shield	-01BJ1* = SMA Bulkhead Jack (RF402 & RF405 not available)		-0152 (152 mm) 5.984" minimum (RF23C & RF180)
RF25S = MWC-2550-01 microwave cable with 25 AWG solid FEP dielectric	-01SB = Straight Bulkhead Jack, Sealed (RF047-A, RF086 & RF23C only)		-0200 (200 mm) 7.87" minimum (RF280)
RF402 = RG 402 (.141") 19 AWG semi-flexible microwave cable	*Remove last "1" from end connector when specifying RF047-A, RF086, RF23C, RF180 & RF280.		

ALSO AVAILABLE

1.00 mm, 1.35 mm, 1.85 mm, 2.40 mm, 2.92 mm, SMPM, SMP = RF047-A

1.85 mm, 2.40 mm, 2.92 mm, SMPM, SMP = RF086

2.40 mm, 2.92 mm, SMPM, SMP = RF23C

SMP = RF25S, RF405

TNCA, N Type = RF180

TNCA, N Type = RF280

SMA Board Connectors

SMA-TH, SMA-SM, SMA-MT, SMA-EM

Cable Mates:
 RF047-A, RF086, RF23C, RF25S, RF402, RF405, RF180, RF280



SMA	GENDER	TYPE	PLATING	ORIENTATION	TERMINATION
	-J = Jack	-P = PCB Mount	-H = 30 μ" (0.76 μm) Gold center contact, 3 μ" (0.08 μm) Gold outer contact	-ST = Straight	-TH1 = Through-hole
			-GF = 10 μ" (0.25 μm) Gold center contact, 3 μ" (0.08 μm) Gold outer contact (-SM1 only)	-RA = Right-angle	-SM1 = Surface Mount (-GF-RA only)
					-EM1 = Edge Mount (-ST only)
					-EM3 = Drop-in Edge Mount (-ST only)
					-MT1 = Mixed Technology (-ST only)

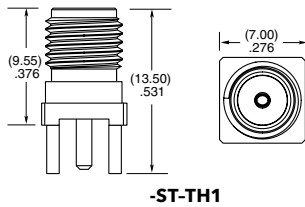

-ST-TH1

SMA Cable Connectors

PRF01



CONNECTORS FOR INDUSTRY STANDARD CABLES

PRF01-P-C-EP-120C-SS	Harbour LL120
PRF01-J-C-EP-142-SS	Harbour LL142
PRF01-P-C-EP-142-SS	Harbour LL142
PRF01-P-C-EP-142-RS	Harbour LL142
PRF01-P-C-EP-142A-SS	Harbour SB142
PRF01-P-C-EP-335-SS	Harbour LL335
PRF01-P-C-EP-335A-SS	Harbour LL335i
PRF01-P-C-EP-190-SS	Semflex HP190
PRF01-P-C-EP-190-RS	Semflex HP190
PRF01-P-C-EP-305-SS	Semflex HP305
PRF01-P-C-EP-290-SS	Semflex LA290

For a complete list of SMA cable connectors, visit www.samtec.com?PRF01

INTERFACE STANDARD

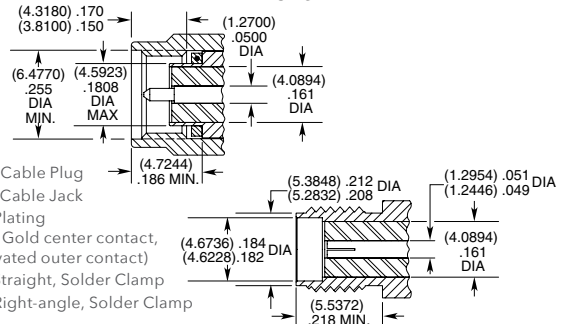

P-C = Cable Plug
 J-C = Cable Jack

EP = Plating

(50 μ" Gold center contact, passivated outer contact)

SS = Straight, Solder Clamp

RS = Right-angle, Solder Clamp

SMMP TO 65 GHz

SMMP Cable Assemblies

RF047-A, RF086, RF23C



VSWR

RF047-A: 1.40 max.
RF086: 1.40 max.
RF23C: 1.20 max. (DC to 26.5 GHz)
 1.40 max. (26.5 GHz to 50 GHz)

SERIES	END 1 CONNECTOR	END 2 CONNECTOR	OVERALL LENGTH
RF047-A = (1.2 mm) .047" overshield DIA 29 AWG millimeter cable RF086 = (2.18 mm) .086" overshield DIA 23 AWG millimeter cable RF23C = MWC-2350CU-01 millimeter wave cable with copper foil shield	-MOSP = SMMP Straight Plug, Full Detent -MOSJ = SMMP Straight Jack -MORJ = SMMP Right-angle Jack (RF047-A only) -MOBJ = SMMP Straight Bulkhead Jack (RF047-A only)	-"XXXX" = Overall Length in millimeters -0100 (100 mm) 3.94" minimum (RF047-A, RF086) -0152 (152 mm) 5.984" minimum (RF23C)	

ALSO AVAILABLE

1.00 mm, 1.35 mm, 1.85 mm, 2.40 mm,
 2.92 mm, SMP, SMA = RF047-A
 1.85 mm, 2.40 mm, 2.92 mm, SMP, SMA = RF086
 2.40 mm, 2.92 mm, SMP, SMA = RF23C

SMMP Board Connectors

SMPM-SM, SMPM-TH,
 SMPM-RA, SMPM-MT,
 SMPM-EM

Cable Mates:

RF047-A, RF086, RF23C



SMPM	GENDER	TYPE	PLATING	ORIENTATION	TERMINATION	1
	-PF = Full Detent -PS = Smooth Bore -PC = Catcher's Mitt (-ST-TH, -ST-MT & -ST-SM only)	-P = PCB Mount	-HG = 30 μ" (0.76 μm) Gold center contact, 10 μ" (0.25 μm) Gold outer contact (-ST only) -HF = 30 μ" (0.76 μm) Gold center contact, 3 μ" (0.08 μm) Gold outer contact (-RA only) -EG = 50 μ" (1.27 μm) Gold center contact and outer body (-MT & -SM only)	-ST = Straight -RA = Right-angle (-TH required)	-EM = Drop-in Edge Mount (-ST only) -TH = Through-hole -SM = Surface Mount (-ST only) -MT = Mixed Technology (-ST only)	
	 -ST-TH-1	 -RA-TH-1	 -ST-SM-1	 -ST-EM-1		

SMMP Cable Connectors

PRFM0



CONNECTORS FOR INDUSTRY STANDARD CABLES	
PRFM0-J-C-EE-085-BD	Harbour SS405
PRFM0-J-C-EE-047A-BD	Temp-Flex 1000671047
PRFM0-J-C-HG-047A-SD	Temp-Flex 1000671047
PRFM0-J-C-EE-047A-RD	Temp-Flex 1000671047
PRFM0-P-C-HG-047A-SD	Temp-Flex 1000671047
PRFM0-J-C-EE-047B-SD	Temp-Flex 1001935047
PRFM0-J-C-EE-086-SD	Temp-Flex 1001935086
PRFM0-P-C-EE-086-SD	Temp-Flex 1001935086

For a complete list of SMMP cable connectors, visit www.samtec.com?PRFM0

INTERFACE STANDARD (CATCHER'S MITT)

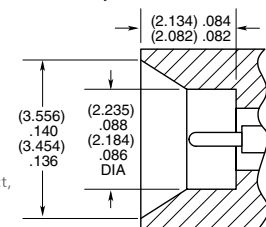

P-C = Cable Plug
 J-C = Cable Jack
 EE = Plating
 (50 μ" Gold center contact,
 & outer contact)
 HG = Plating
 (30 μ" Gold center contact,
 10 μ" Gold outer contact)
 SD = Straight, Direct Solder
 BD = Bulkhead, Direct Solder
 RD = Right-angle, Direct Solder

SMPM TO 65 GHZ

SMPM Ganged Cable: GC47, GC86

Mates With: GPPC



SERIES	NO. OF ROWS	NO. OF POSITIONS	ASSEMBLY LENGTH
--------	-------------	------------------	-----------------

GC47
= Ganged SMPM with (1.2 mm) .047" overshield DIA 29 AWG millimeter wave cable

GC86
= Ganged SMPM with (2.18 mm) .086" overshield DIA 23 AWG millimeter wave cable

-1

-02, -04, -06, -08, -10

-"XXXX"
= Assembly Length in millimeters -0100 (100 mm) 3.94" minimum

NO. OF POSITIONS	A	B
-02	(8.89) .350	(3.56) .140
-04	(16.00) .630	(10.67) .420
-06	(22.10) .870	(17.78) .700
-08	(30.23) 1.190	(24.89) .980
-10	(37.34) 1.470	(32.00) 1.260

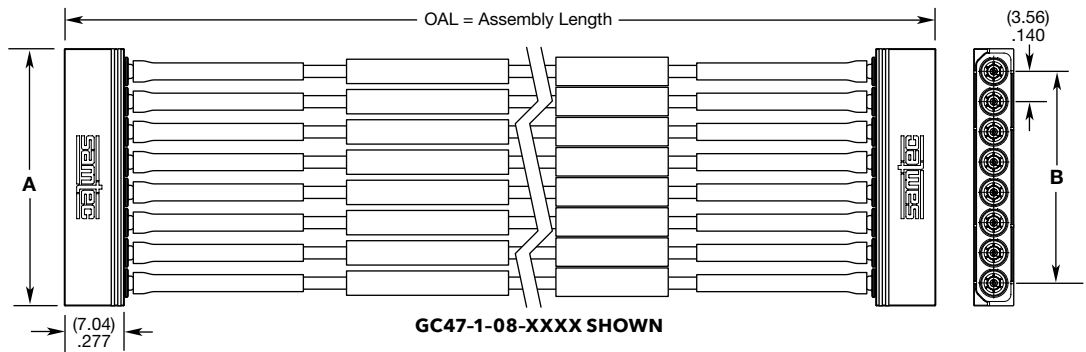

ALSO AVAILABLE

Other RF options for end 2
Contact RFGroup@samtec.com

Notes:
Cable lengths longer than 1000 mm (39.37") are not supported with S.I. test data.

Some sizes, styles and options are non-standard, non-returnable.

SMPM Ganged Block: GPPC

Mates With: GC47, GC86



GPPC	GENDER	1	NO. OF POSITIONS	PLATING	ORIENTATION	TERMINATION	1N
------	--------	---	------------------	---------	-------------	-------------	----

-PF
= Plug Full Detent

-PS
= Plug Smooth Bore

-PC
= Catcher Mitt (-ST-SL & -RA-SM only)

-02, -04, -06, -08, -10 (Per Row)

-EG
= 50 μ" (1.27 μm) heavy Gold center contact, 10 μ" (0.25 μm) extra Gold outer body (-EM only)

-HG
= 30 μ" (0.76 μm) Gold center contact, 10 μ" (0.25 μm) Gold outer body (-SL & -SM only)

-ST
= Straight

-RA
= Right-angle (-SM only)

-SM
= Surface Mount (Right-angle only)

-EM
= Edge Mount

-SL
= Stub Launch

Leave blank for -SL & -SM

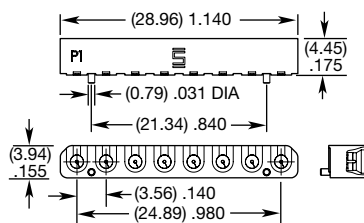

NO. OF POSITIONS	A	B	C	D	E
-02	(9.35) .368	(7.70) .303	(3.56) .140	(7.62) .300	N/A
-04	(16.46) .648	(14.81) .583	(10.67) .420	(14.73) .580	(7.11) .280
-06	(23.57) .928	(21.92) .863	(17.78) .700	(21.84) .860	(14.22) .560
-08	(30.68) 1.208	(29.03) 1.143	(24.89) .980	(28.96) 1.140	(21.34) .840
-10	(37.80) 1.488	(36.14) 1.423	(32.00) 1.260	(36.07) 1.420	(28.45) 1.120

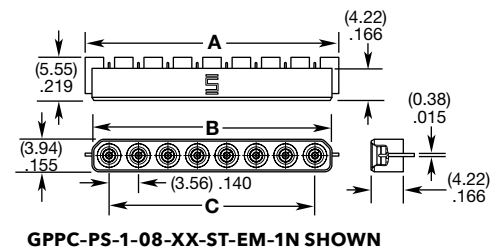
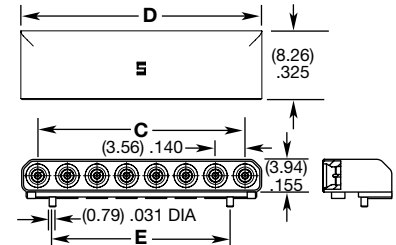

Notes:
Some sizes, styles and options are non-standard, non-returnable.

SMPM TO 65 GHz

SMPM Ganged Block:
GPPB

Mates With:
PRFIA



GPPB	GENDER	NO. OF ROWS	NO. OF POSITIONS	PLATING	ST	SM	CHANNEL PITCH
------	--------	-------------	------------------	---------	----	----	---------------

- PF**
= Plug Full Detent
- PS**
= Plug Smooth Bore
- PC**
= Catcher's Mitt
- 1**
- 02, -04, -06, -08, -10**
- EG**
= 50 μ" (1.27 μm) heavy Gold center contact, 10 μ" (0.25 μm) Gold outer body
- 1N**
= 3.56 mm (.140") Pitch

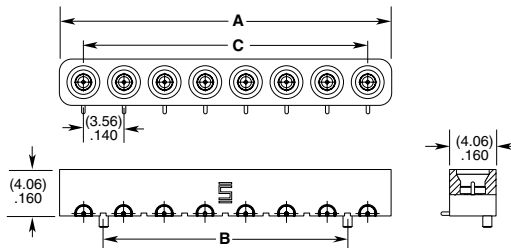

NO. OF POSITIONS	A	B	C
-02	(7.62) .300	N/A	(3.56) .140
-04	(14.73) .580	(7.11) .280	(10.67) .420
-06	(21.84) .860	(14.22) .560	(17.78) .700
-08	(28.96) 1.14	(21.34) .840	(24.89) .980
-10	(36.07) 1.42	(28.45) 1.12	(32.00) 1.26

GPPB-PF-1-08-EG-ST-SM-1N SHOWN

ALSO AVAILABLE

(8.33 mm) .328" Pitch
(5.08 mm) .200" Pitch
Edge Mount termination
Contact: RFGroup@samtec.com

DUAL POSITION SOLDERLESS COMPRESSION MOUNT

SMPM Ganged Block:
GPPC

Mates With:
GC47, GC86, PRFIA



GPPC	GENDER	1	2	PLATING	ORIENTATION	TERMINATION	PACKAGING
------	--------	---	---	---------	-------------	-------------	-----------

- PF**
= Plug Full Detent
- PS**
= Plug Smooth Bore
- EP**
= 50 μ" (1.27 μm) heavy Gold center contact, Passivated outer body
- ST**
= Straight
- CMM**
= Compression Mount
- Leave blank for Individually bagged
- B**
= Bulk Package

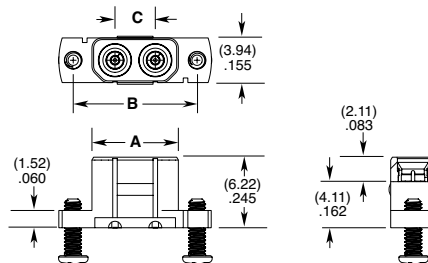

NO. OF POSITIONS	A	B	C
-02	(7.62) .300	(10.92) .430	(3.56) .140

GPPC-PX-1-2-EP-ST-CMM-X SHOWN

SMP TO 40 GHz

SMP Cable Assemblies

RF047-A, RF086, RF23C, RF25S, RF405



VSWR

RF047-A: 1.50 max.
RF086: 1.50 max.
RF23C: 1.50 max.
RF25S: Contact Samtec
RF405: Contact Samtec

SERIES	END 1 CONNECTOR	END 2 CONNECTOR	OVERALL LENGTH
RF047-A = (1.2 mm) .047" overshield DIA 29 AWG millimeter wave cable	-00SJ = SMP Straight Jack (RF047-A, RF086 & RF23C only)		-"XXXX" = Overall Length in millimeters
RF086 = (2.18 mm) .086" overshield DIA 23 AWG millimeter wave cable	-00MJ = SMP Right-angle Jack (RF047-A, RF086 & RF23C only)		-0100 (100 mm) 3.94" minimum (RF047-A, RF086, RF23C)
RF23C = MWC-2350CU-01 millimeter wave cable with copper foil shield	-00BF = SMP Bulkhead Jack, Full Detent (RF086 & RF23C only)		-0152 (152 mm) 5.984" minimum (RF23C)
RF25S = MWC-2550-01 microwave cable with 25 AWG solid FEP dielectric	-00BL = SMP Bulkhead Jack, Limited Detent (RF086 & RF23C only)		
RF405 = RG 405 (.086") 24 AWG semi-flexible microwave cable	-00BS = SMP Bulkhead Jack, Smooth Bore (RF086 & RF23C only)		
	-00BC = SMP Bulkhead Jack, Catcher's Mitt (RF086 & RF23C only)		
	-00SJ7 = SMP Straight Jack (RF25S & RF405 only)		
	-00RJ7 = SMP Right-angle Jack (RF25S & RF405 only)		

ALSO AVAILABLE

1.00 mm, 1.35 mm, 1.85 mm, 2.40 mm, 2.92 mm, SMPM, SMA = RF047-A
 1.85 mm, 2.40 mm, 2.92 mm, SMPM, SMA = RF086
 2.40 mm, 2.92 mm, SMPM, SMA = RF23C
 SMA = RF25S
 SMA = RF405

SMP Cable Connectors

PRF00



CONNECTORS FOR INDUSTRY STANDARD CABLES	
PRF00-J-C-EE-047A-RD	Temp-Flex 1000671047
PRF00-J-C-EE-085A-SD	.086 Semi-Rigid
PRF00-PF-C-KK-047D-BD	.047 Semi-Rigid

For a complete list of SMP cable connectors, visit www.samtec.com?PRF00

J-C = Cable Jack

EE = Plating (50 μ" Gold center contact & outer contact)

KK = Plating (100 μ" Gold over Nickel center contact, passivated outer contact)

BD = Bulkhead, Direct Solder

SD = Straight, Direct Solder

RD = Right-angle, Direct Solder

INTERFACE STANDARD (FULL DETENT)

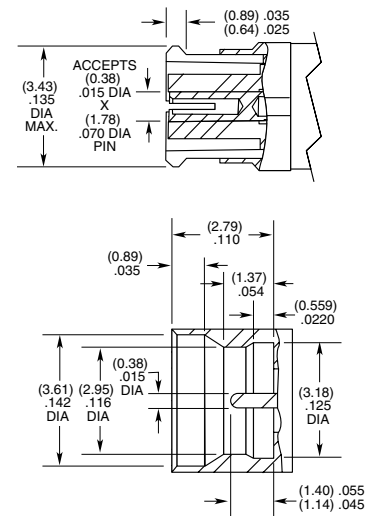

SMP TO 40 GHz

SMP Board Connectors

SMP-TH, SMP-EM,
SMP-MT, SMP-SM

Cable Mates:

RF047-A, RF086,
RF23C, RF405, RF25S



SMP	GENDER	TYPE	PLATING	ORIENTATION	TERMINATION
-----	--------	------	---------	-------------	-------------

- PF**
= Plug, Full Detent
- PL**
= Plug, Limited Detent
- PS**
= Plug, Smooth Bore
- PC**
= Plug, Catcher's Mitt
- P**
= PCB Mount
- HG**
= 30 μ " (0.76 μ m)
Gold center contact,
10 μ " (0.25 μ m)
Gold outer body
- ST**
= Straight
- SM**
= Surface Mount
(Not available with PS)
- TH"X"**
= Through-hole
(Specify "X"
from chart)
- MT"X"**
= Mixed Technology
(Specify "X"
from chart)
- EM**
= Edge Mount
(-PL & -PS only)

OPTION (X)	A (HEIGHT DIM.)	BOARD THICKNESS
1	(5.88) .2315	(1.60 mm) .062" PCB
2	(6.54) .2575	(2.36 mm) .093" PCB

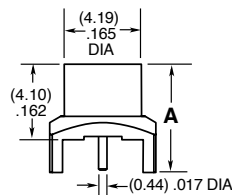

-PF/-PL/-PS-TH2

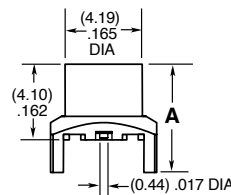

-MT(X)

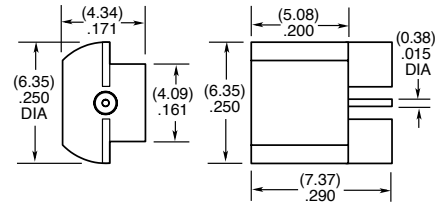

-EM

ALSO AVAILABLE

Low Frequency options.
Contact RFGroup@samtec.com

SMP Bullet Adaptor

SMP-B



SMP	J	TYPE	PLATING	ORIENTATION	BULLET LENGTH
-----	---	------	---------	-------------	---------------

- B**
= Bullet Adaptor
- HG**
= 30 μ " (0.76 μ m)
Gold center contact,
10 μ " (0.25 μ m)
Gold outer body
- ST**
= Straight
- 0591**
= (5.91 mm) .233"
- 0645**
= (6.45 mm) .254"
- 0690**
= (6.90 mm) .272"
- 0795**
= (7.95 mm) .313"
- 0896**
= (8.96 mm) .353"
- 1305**
= (13.05 mm) .514"
- 1450**
= (14.50 mm) .571"

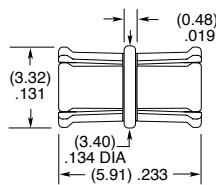

-0591

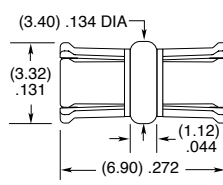

-0690

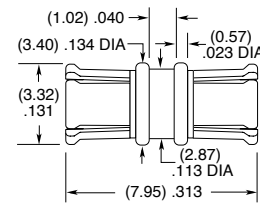

-0795

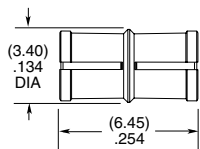

-0645

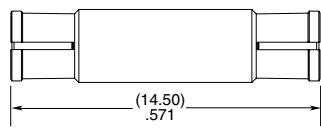

-1450

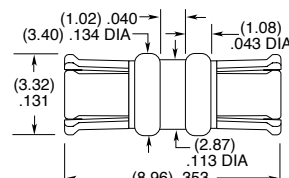

-0896

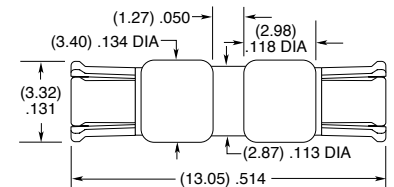

-1305

N TYPE TO 18 GHz

N Type Cable Assemblies

RF180, RF280



VSWR

RF 180:
1.35 max. (-06SP & -06BJ)
1.45 max. (-06RP)

RF 280:
1.35 max. (-06SP & -06BJ)
1.35 max. (DC to 14 GHz) (-06RP)
1.50 max. (14 GHz to 18 GHz)

SERIES	END 1 CONNECTOR	END 2 CONNECTOR	OVERALL LENGTH
RF180 = (4.52 mm) .178" overshield DIA, 16 AWG microwave cable	-06SP = N Type Straight Plug		-"XXXX" = Overall length in millimeters
RF280 = (7 mm) .277" overshield DIA, 11 AWG microwave cable	-06RP = N Type Right-angle Plug		-0152 (152 mm) 5.984" minimum (RF180)
	-06BJ = N Type Straight Bulkhead Jack		-0200 (200 mm) 7.87" minimum (RF280)

ALSO AVAILABLE

SMA, TNCA = RF180
SMA, TNCA = RF280

N Type Cable Connectors

PRF06



CONNECTORS FOR INDUSTRY STANDARD CABLES	
PRF06-P-C-EP-141A-SS	Harbour SS402
PRF06-J-C-EP-142-BS	Harbour LL142
PRF06-P-C-EP-142-SS	Harbour LL142
PRF06-P-C-EP-142-RS	Harbour LL142
PRF06-P-C-EP-142A-SS	Harbour SB142
PRF06-J-C-EP-335-BS	Harbour LL335
PRF06-P-C-EP-335-SS	Harbour LL335
PRF06-P-C-EP-335-RS	Harbour LL335
PRF06-P-C-EP-335A-SS	Harbour LL335i
PRF06-P-C-EP-335A-SS	Harbour LL335i
PRF06-P-C-EP-335A-RS	Harbour LL335i
PRF06-J-C-EP-160A-BS	Harbour LL160
PRF06-P-C-EP-160A-SS	Harbour LL160
PRF06-P-C-EP-160A-RS	Harbour LL160
PRF06-P-C-EP-120A-SS	Semflex HP120
PRF06-J-C-EP-190-BS	Semflex HP190
PRF06-P-C-EP-190-SS	Semflex HP190
PRF06-P-C-EP-190-RS	Semflex HP190
PRF06-J-C-EP-290-BS	Semflex LA290
PRF06-P-C-EP-290-SS	Semflex LA290
PRF06-P-C-EP-290-RS	Semflex LA290
PRF06-P-C-EP-305-SS	Semflex HP305
PRF06-J-C-EP-402-4S	RG 402, .141, semi-rigid
PRF06-P-C-EP-300A-SS	Times Max Gain 300
PRF06-P-C-EP-180B-SS	IW 1801
PRF06-P-C-EP-135-SS	Dynawave DF440W
PRF06-P-C-EP-270A-RS	Dynawave DF218
PRF06-P-C-EP-160B-SS	ATM CF-210
PRF06-P-C-EP 135B-SS	Lab-Flex 160S
PRF06-P-C-EP-284-SS	Micro-Coax UFB311A

For a complete list of N Type cable connectors, visit www.samtec.com?PRF06

INTERFACE STANDARD

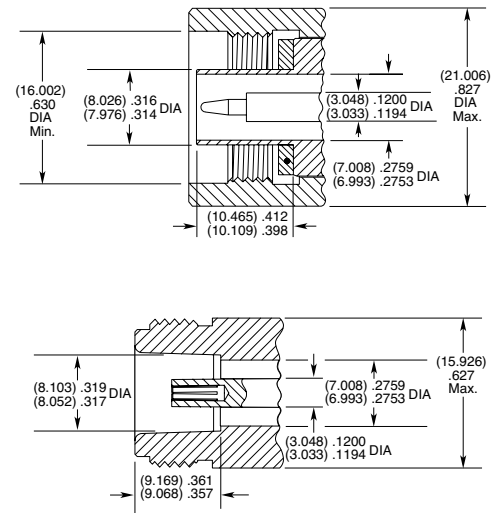

P-C = Cable Plug
J-C = Cable Jack
EP = Plating (50 μ" Gold center contact, passivated outer contact)
SS = Straight, Solder Clamp
RS = Right-angle, Solder Clamp
BS = Bulkhead, Solder Clamp
4S = 4-hole Flange, Solder Clamp

TNCA TO 18 GHz

TNCA Cable Assemblies

RF180, RF280



VSWR

RF180: 1.35 max. (-04SP & -04BJ)
1.45 max. (-04RP)
RF280: 1.35 max. (-04SP & -04BJ)

SERIES	END 1 CONNECTOR	END 2 CONNECTOR	OVERALL LENGTH
RF180 = (4.52 mm) .178" overshield DIA, 16 AWG microwave cable RF280 = (7 mm) .277" overshield DIA, 11 AWG microwave cable	-04SP = TNCA Straight Plug -04RP = TNCA Right-angle Plug (RF180 only) -04BJ = TNCA Straight Bulkhead Jack	-"XXXX" = Overall length in millimeters -0100 (100 mm) 3.94" minimum (RF180) -0200 (200 mm) 7.87" minimum (RF280)	

ALSO AVAILABLE

SMA, N Type = RF180
SMA, N Type = RF280

TNCA Cable Connectors

PRF04



CONNECTORS FOR INDUSTRY STANDARD CABLES	
PRF04-P-C-EP-142-RS	Harbour LL142
PRF04-J-C-EP-142-BS	Harbour LL142
PRF04-P-C-EP-142-SS	Harbour LL142
PRF04-P-C-EP-335-SS	Harbour LL335
PRF04-P-C-EP-290-SS	Semflex LA290
PRF04-J-C-EP-190-BS	Semflex HP190
PRF04-P-C-EP-190-RS	Semflex HP190
PRF04-P-C-EP-190-SS	Semflex HP190
PRF04-P-C-EP-335A-RS	Harbour LL335i
PRF04-J-C-EP-335A-BS	Harbour LL335i
PRF04-P-C-EP-300A-SS	Times Max Gain 300
PRF04-P-C-EP-200-SS	Times Max Gain 200
PRF04-P-C-EP-160A-SS	Harbour LL160
PRF04-J-C-EP-270A-BS	Dynawave DF218
PRF04-P-C-EP-135-SS	Dynawave DF440W
PRF04-P-C-EP-300A-SS	Times Max Gain 300
PRF04-J-C-EP-210A-BS	Micro-Coax UFA210A
PRF04-P-C-EP-210A-SS	Micro-Coax UFA210A
PRF04-P-C-EP-284-SS	Micro-Coax UFB311A
PRF04-J-C-EP-127-4S	Storm VSR150

For a complete list of TNCA cable connectors, visit www.samtec.com?PRF04

INTERFACE STANDARD

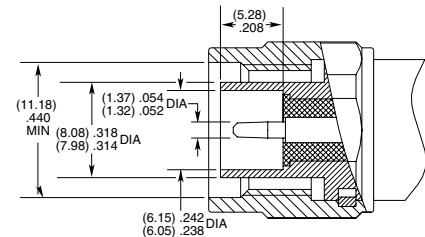
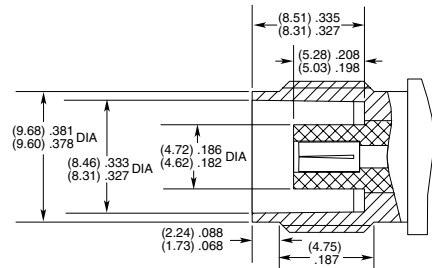

P-C = Cable Plug
J-C = Cable Jack
EP = Plating (50 μ" Gold center contact, passivated outer contact)
SS = Straight, Solder Clamp
RS = Right-angle, Solder Clamp
BS = Bulkhead, Solder Clamp
4S = 4-Hole Flange

IN-SERIES PRECISION RF ADAPTORS

1.85 mm, 2.40 mm, 2.92 mm In-Series Adaptors
PRFIA



VSWR

-185: 1.30 max.
-240: 1.20 max.
-292: 1.15 max.

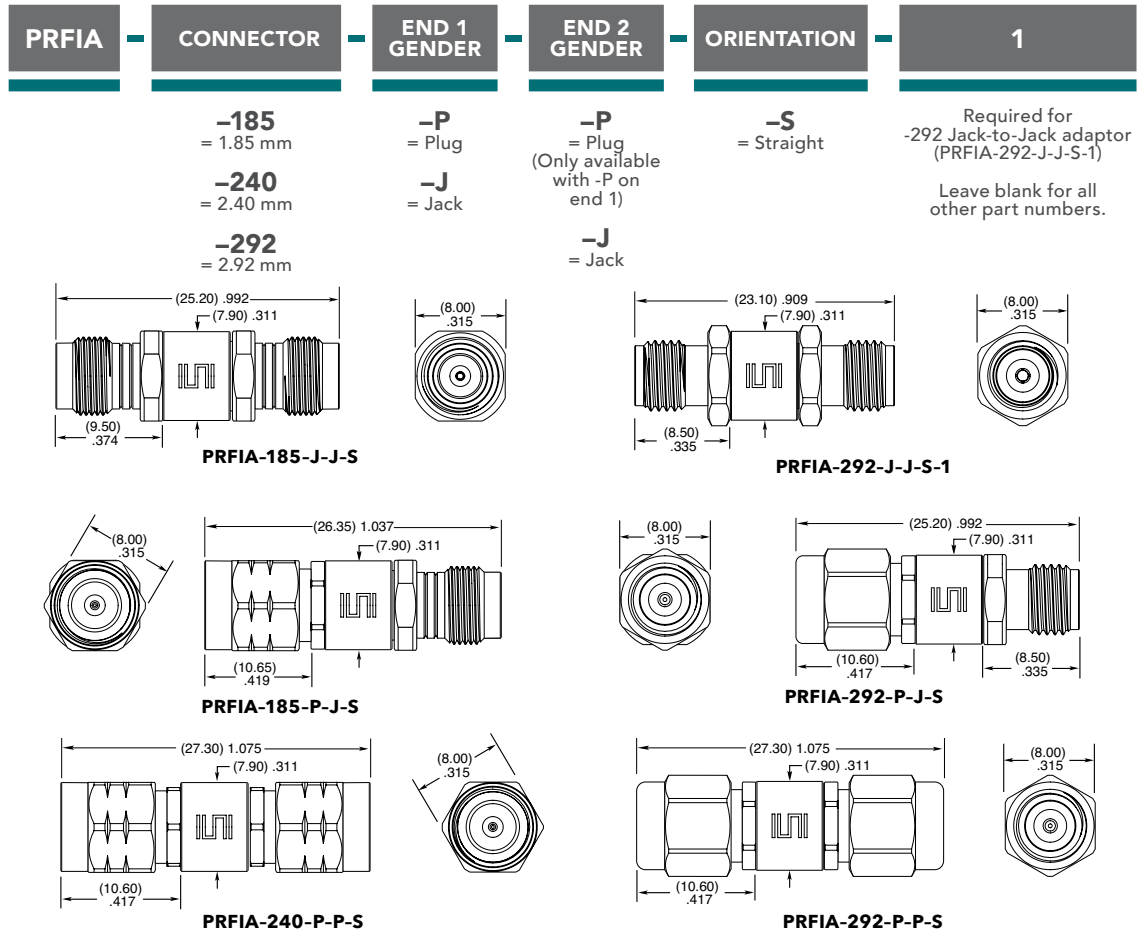

SMPM In-Series Adaptor:
PRFIA

Mates With:
SMPM, GPPB, GPPC



VSWR

1.15 max. (DC to 26.5 GHz)
1.35 max. (26.5 GHz to 40 GHz)
1.50 max. (40 GHz to 65 GHz)

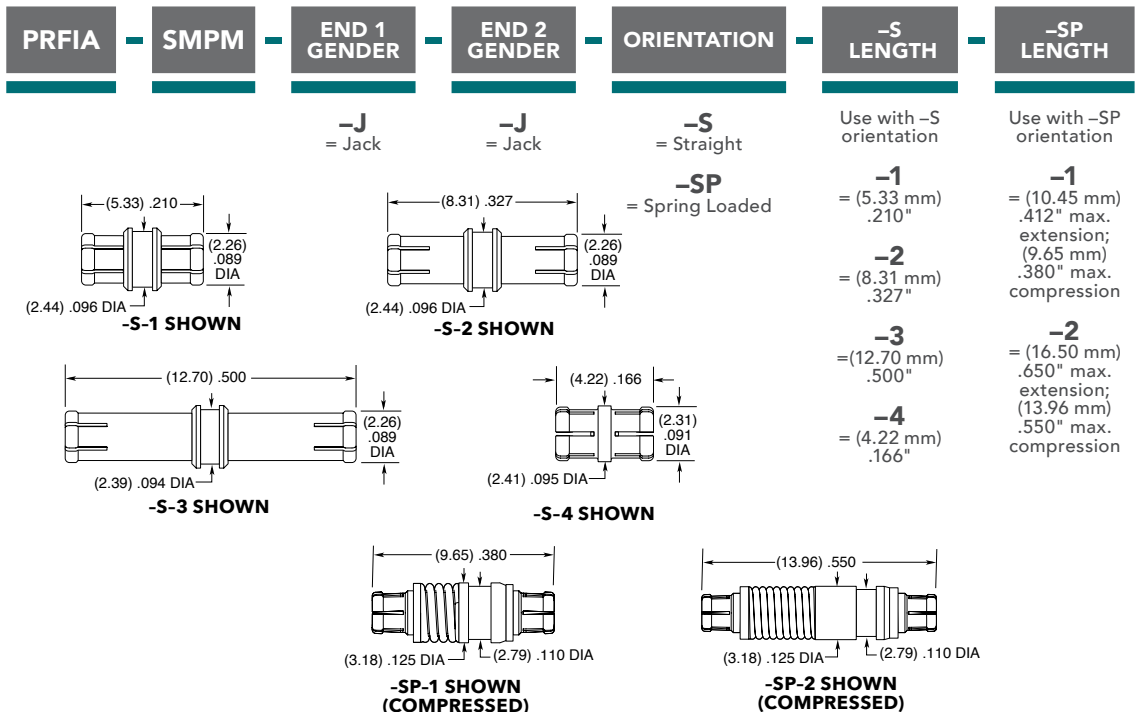

BETWEEN-SERIES PRECISION RF ADAPTORS

1.00 mm to 1.85 mm Adaptors

PRFBA



VSWR

1.12 max. (DC to 26.5 GHz)
 1.25 max. (26.5 GHz to 40 GHz)
 1.30 max. (40 GHz to 50 GHz)
 1.35 max. (50 GHz to 67 GHz)

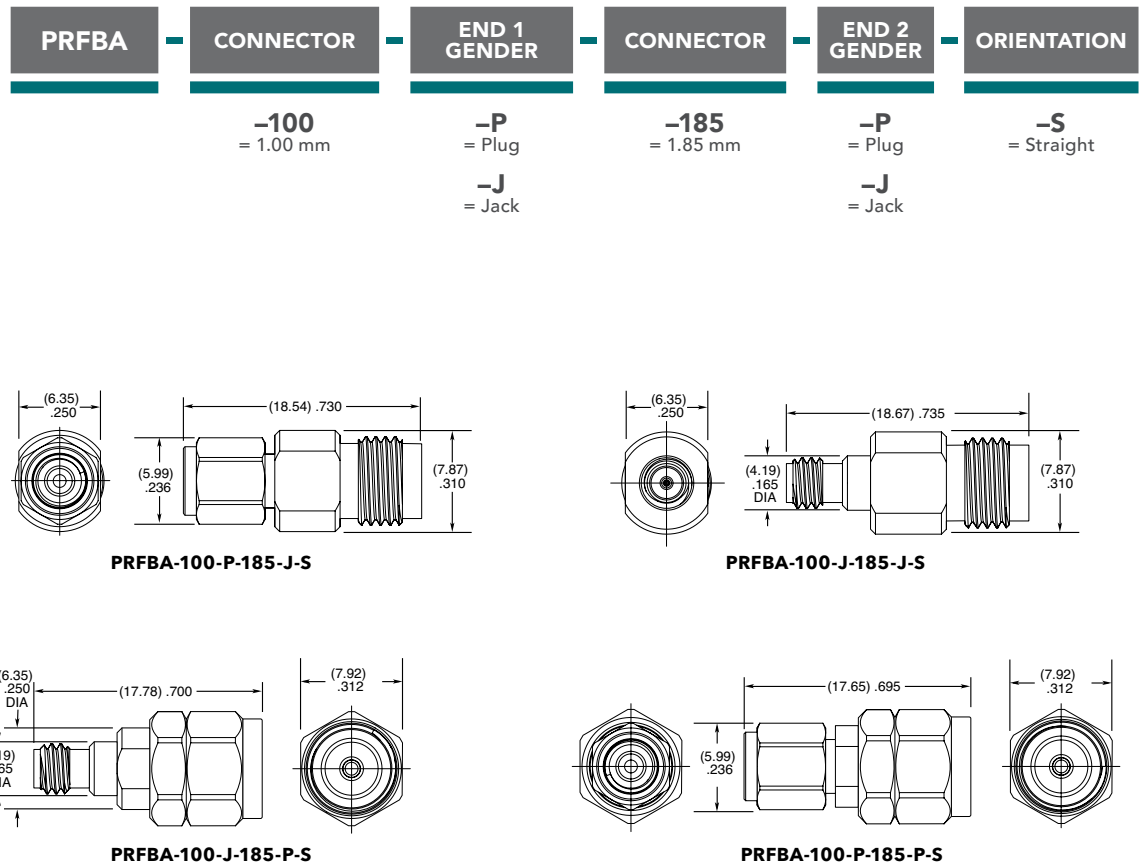

2.92 mm to SMPM Adaptors

PRFBA



VSWR

1.30 max. (DC to 40 GHz)

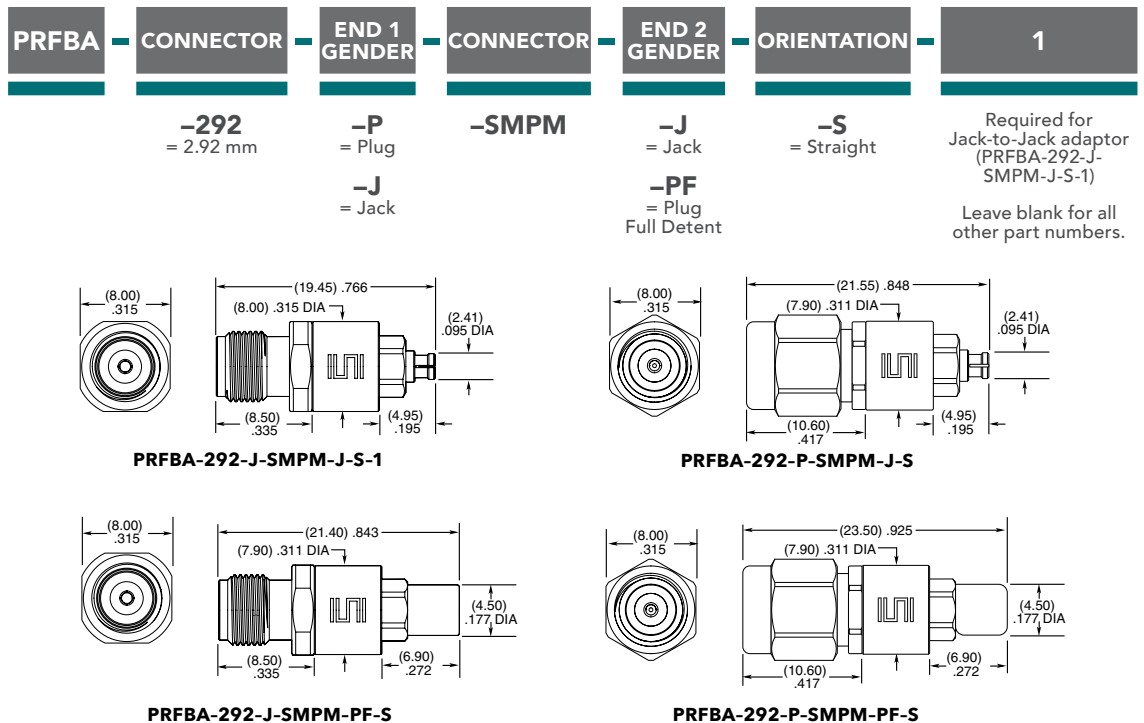

HIGH-PERFORMANCE TEST ASSEMBLIES TO 90 GHz

FEATURES & BENEFITS

The Bulls Eye® high-performance test assembly features a high-density, space-saving design that enables smaller evaluation boards and shorter trace lengths in test and measurement applications to 90 GHz.

- Compression mounts to the board for placement directly adjacent to the SerDes being characterized
- Solderless design improves cost and is easy to use within a lab setting
- End 2 connection to instrumentation: 1.00 mm, 1.35 mm, 1.85 mm, 2.40 mm or 2.92 mm
- High-density, space-saving design
- Single row or double row
- Complete list of applications: SerDes characterization, clock/data recovery (CDR), mmWave radar, automated test equipment, FR2 5G networks

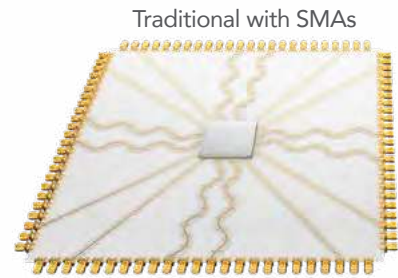

DC TO	PAM 4
90 GHz	224 Gbps

HIGH-DENSITY & SPACE-SAVING

Enables smaller evaluation boards and shorter trace lengths.



PRODUCT FAMILY CROSS REFERENCE GUIDE

ASSEMBLY	90 GHz	70 GHz	50 GHz	40 GHz	TEST ASSEMBLY	SERDES CHARACTERIZATION		
Block Bottom View					BE90A, 90 GHz	<table border="1"> <tr><td>PAM 4</td></tr> <tr><td>224 Gbps</td></tr> </table>	PAM 4	224 Gbps
PAM 4								
224 Gbps								
End 2 Connector	1.00 & 1.35 mm	1.85 mm	2.40 mm	2.92 mm				
Samtec Series	BE90A	BE70A	BE40A					
Cable Type	.047	.086	MWC-2350CU-01					
Cable Management	Yes				BE70A, 70 GHz	<table border="1"> <tr><td>PAM 4</td></tr> <tr><td>112 Gbps</td></tr> </table>	PAM 4	112 Gbps
PAM 4								
112 Gbps								
PCB Transition	Microstrip/CPW or Stripline							
Bulls Eye® Connector Design	Spring-Loaded Contact; 360° Grounding		Pogo-Pin for Signal & Ground					
No. of Rows	Single or Double		Double					
No. of Positions	1x: 2, 4, 8, 12 2x: 4, 8, 12, 16	1x: 2, 4, 8, 12 2x: 3, 4, 6, 8, 10, 12, 14, 16	2x: 3, 4, 6, 8, 10, 12, 14, 16		BE40A, 50 GHz	<table border="1"> <tr><td>PAM 4</td></tr> <tr><td>56 Gbps</td></tr> </table>	PAM 4	56 Gbps
PAM 4								
56 Gbps								
Impedance	50 Ω							
FPGA Development Kit	-		Xilinx® Zynq® UltraScale+™ RFSoc ZCU1275					
SI Evaluation Kit	-	70 GHz: REF-213864-01	50 GHz: REF-213497-01					

90 GHz ASSEMBLIES

BE90A	TRANSMISSION TYPE	END 2	PHASE MATCHING	ROW OPTION	POSITIONS PER ROW	OVERALL LENGTH
	-S = Stripline -M = Microstrip	-10BJ = 1.00 mm Straight Jack -10SP = 1.00 mm Straight Plug -13BJ = 1.35 mm Straight Jack -13SP = 1.35 mm Straight Plug	-1 = 1.0 Pico-second -2 = 2.0 Pico-second -5 = 5.0 Pico-second -N = No Phase Matching	-1 = Single Row (-02, -04, -08 & -12 positions only) -2 = Double Row (-04, -08, -12 & 16 positions only)	-02, -04, -08, -12, -16	-“XXXX” = Overall length in millimeters -0152 (152 mm) 5.984" minimum

BE90A

End 2 Connectors:
1.00 mm, 1.35 mm

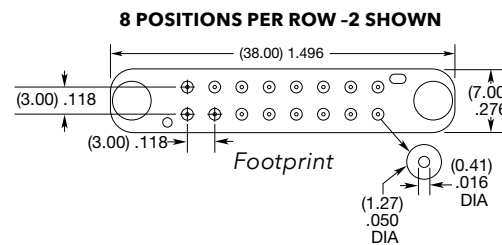
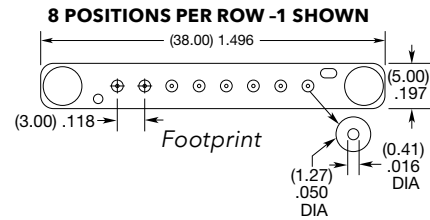
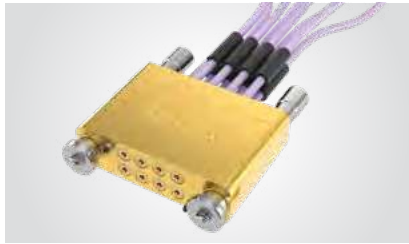

BE90A, 2 X 4 FOOTPRINT

Performance was measured using 50 Ohm coplanar waveguide (CPW) transmission line and 6 layer PCB (Isola Tachyon). The BE90A DUT consisted of a 2 row x 4 position -M (CPW/microstrip) block, 6-inch (152 mm) low-loss microwave cable and 1.00 mm end 2 connectors. Results include the breakout region and BE90A cable assembly. All other effects have been removed by de-embedding (AFR technique).

Insertion Loss Performance

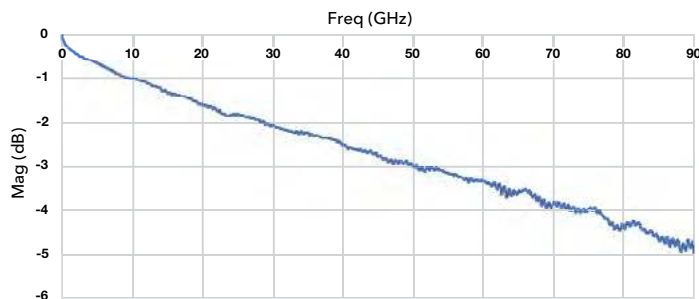

MEASURED: BREAKOUT REGION + BE90A

Return Loss Performance

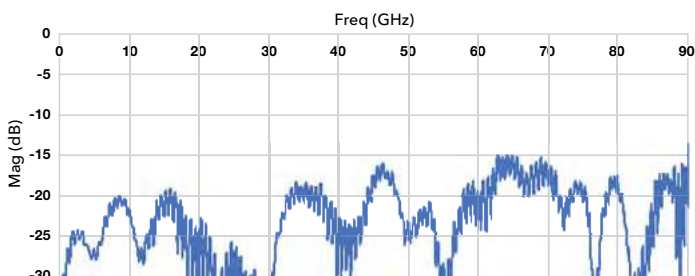

MEASURED: BREAKOUT REGION + BE90A

70 GHz ASSEMBLIES

BE70A	TRANSMISSION TYPE	END 2	PHASE MATCHING	ROW OPTION	POSITIONS PER ROW	OVERALL LENGTH
	-S = Stripline -M = Microstrip	-18SJ = 1.85 mm Straight Jack -18SP = 1.85 mm Straight Plug	-2 = 2.0 Pico-second -5 = 5.0 Pico-second -N = No Phase Matching	-1 = Single Row (-02, -04, -08 & -12 positions only) -2 = Double Row (-03 through -16 positions only)	-02, -03, -04, -06, -08, -10, -12, -14, -16	"XXXX" = Overall length in millimeters -0152 (152 mm) 5.984" minimum

DC TO **70** GHz
PAM 4 **112** Gbps

BE70A
End 2 Connectors:
1.85 mm (70 GHz)

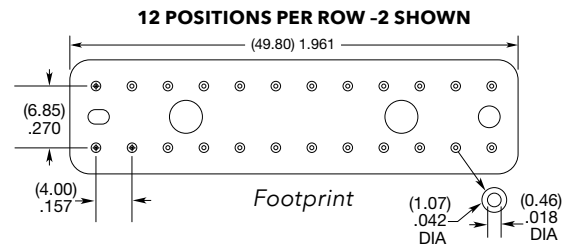
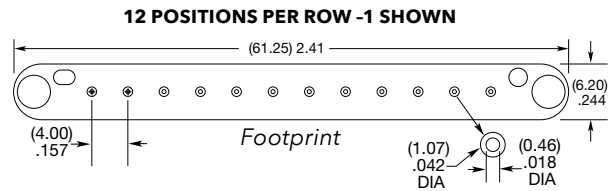

50 GHz & 40 GHz ASSEMBLIES

BE40A	TRANSMISSION TYPE	END 2	PHASE MATCHING	2	POSITIONS PER ROW	OVERALL LENGTH
	-S = Stripline -M = Microstrip	-92SJ = 40 GHz, 2.92 mm Straight Jack -24SJ = 50 GHz, 2.40 mm Straight Jack -92SP = 40 GHz, 2.92 mm Straight Plug -24SP = 50 GHz, 2.40 mm Straight Plug	-2 = 2.0 Pico-second -5 = 5.0 Pico-second -N = No Phase Matching		-03, -04, -06, -08, -10, -12, -14, -16	"XXXX" = Overall length in millimeters -0152 (152 mm) 5.984" minimum

DC TO **50** GHz
PAM 4 **56** Gbps

BE40A
End 2 Connectors:
2.40 mm (50 GHz)
2.92 mm (40 GHz)

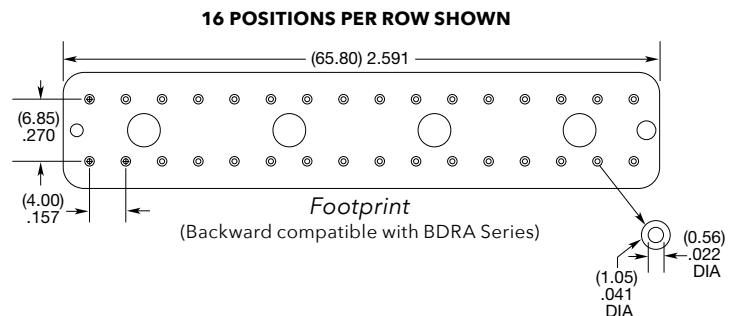

NEXT GENERATION FLEXIBLE WAVEGUIDE



HIGH FREQUENCY • FLEXIBLE CABLE • SMALL FORM FACTOR • LOW LOSS

Samtec's new, high frequency micro waveguide technology is designed to support the demands of next generation millimeter wave systems. It uses a cable design allowing flexibility and a reduced size, and supports frequencies up to 90 GHz (E-band), but with a loss performance greatly improved over coaxial cables.

Due to loss requirements, higher frequencies often require the use of rigid, metallic waveguides. However, Samtec's innovative technology provides an alternative solution that is flexible, easier to use, and lower cost, while also maintaining the near-loss performance of a traditional rigid waveguide.

LOSS COMPARISON

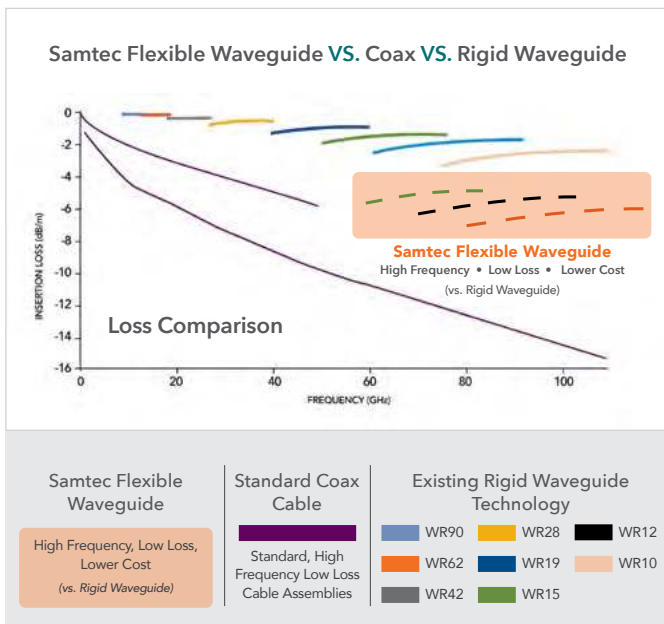

E-BAND, FLEXIBLE WAVEGUIDE

- 60 GHz to 90 GHz, E-band
- Low loss
- Flexible cable with dynamic stability
- Ultra-small form factor

PRODUCT	SERIES	FREQUENCY BAND	DIMENSIONS
Waveguide	WF12	E (60 to 90 GHz)	Overall Length: 102 mm (4.00") Min.
	WGBA		Threaded Plug: 5 mm (.196") x 8 mm (.314")
Adaptor	WGBA		Diameter: 19.05 mm (.750") (mates with WR12 standard flange)

Also Available: V-Band (50 to 75 GHz)

WF15 Series Flexible Waveguide
Cross Section: 3.76 mm (.148") x 1.88 mm (.074") nom.
UG-385 flange adaptor to Threaded Waveguide Jack

FLEXIBILITY & STABILITY

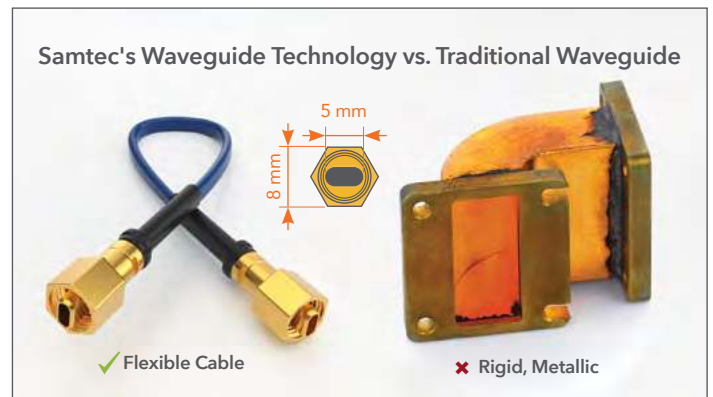
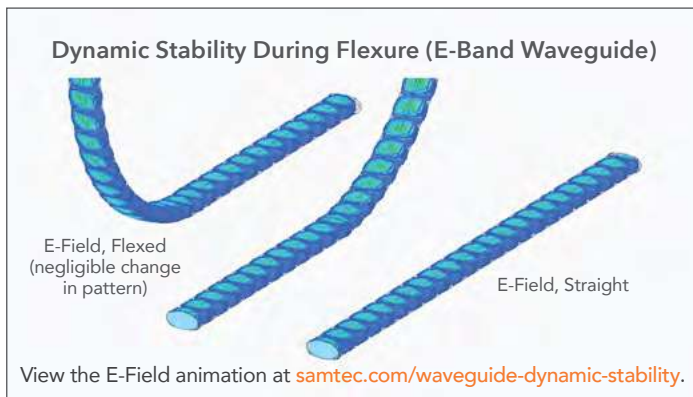

View complete specifications at: samtec.com?WF12 and samtec.com?WGBA

LOW FREQUENCY CABLE SPECIFICATIONS

STANDARD OFF-THE-SHELF ASSEMBLIES

SERIES	MH081	MH113	RF178	RF174	IJ5C [†] (IsoRate [®])	RF316, IJ5C, IJ5H, GRF1-C, GRF1H-C	RS316	RF058	RF179, GRF7-C, GRF7H-C	RFB8T	RFC8T	RFB6T	RFC6T	RFA6T	C28S		
TYPE	50 Ω CABLES								75 Ω CABLES						100 Ω CABLES		
	0.81 mm (34 AWG)	1.13 mm (31 AWG)	RG 178 (28 AWG)	RG 174 (24 AWG)	Samtec 26 AWG, high-temp micro coax	RG 316 (24 AWG)	RG 316, double shielded (24 AWG)	RG 58 (20 AWG)	RG 179 (28 AWG)	Belden 1855A (23 AWG)	12G-SDI, Belden 4855R (23 AWG)	Belden 1694A (18 AWG)	12G- SDI, Belden 4694R (18 AWG)	RG 6 (18 AWG)	Samtec 28 AWG, shielded twisted pair		
ELECTRICAL																	
Impedance	Ω	50 ± 3	50 ± 2	50 ± 5	50 ± 2	50 ± 3	75 ± 3						100 ± 5				
Insertion Loss (dB/m)	100 MHz	1.00	0.60	0.50	0.40	0.68	0.30	1.40 @ 2 GHz	0.20	0.30	0.12		0.07	0.06	0.07	-----	
	1 GHz	3.10	1.90	1.70	1.40	2.37	1.25	1.60 @ 3 GHz	0.80	0.80	0.37	0.36	0.21	0.19	0.21	-----	
	6 GHz	8.60	4.90	5.90	4.40	6.53	4.25	2.20 @ 5 GHz	5.40	3.60	0.97	0.91	0.59	0.51	0.59	-----	
Propagation Delay	nS/m	4.70	4.70	4.83	5.06	4.17	4.83	-----	5.05	4.83	4.12		4.06		3.92	4.03	-----
Current Rating	Amps	1.20	2.10	3.00	5.00	3.00	5.00	-----	-----	3.00	5.00	4.70	-----	16.00	-----		
Capacitance	pF/m	100.00	95.00	96.00	101.00	85.60	96.00	95.80	102.00	64.00	55.70	53.40	53.14	52.20	53.14	38.00	
CONSTRUCTION																	
Center Conductor	Material	Silver Plated Copper		Silver Plated Copper Clad Steel	Bare Copper	Silver Plated Copper	Silver and Copper Plated Steel	Silver Plated Copper Clad Steel	Tinned Copper	Silver Plated Copper	Bare Copper	Silver Plated Copper	Bare Copper	Silver Plated Copper	Bare Copper	Silver Plated Copper	
	AWG	34	31	28	24	26	24		20	28	23		18		28		
Dielectric	Material	FEP		PTFE	KLPE	Foamed FEP	PTFE	FEP	Solid Polyethylene	PTFE	FHDPE	PE (Foam)	FHDPE	PE (Foam)	FHDPE	FEP	
Shield	Material	Silver Plated Copper	Tinned Copper	Silver Plated Copper	Tinned Copper	Silver Plated Copper			Tinned Copper	Silver Plated Copper	1. Al Foil-Polyester Tape-Al Foil 2. Tinned Copper		1. Bonded Al Foil 2. Al Wire		1. Al Foil-Polyester Tape-Al Foil 2. Tinned Copper		Silver Plated Copper
Jacket	Material	PFA	FEP		PVC	FEP			PVC	FEP	PVC						
MECHANICAL																	
Operating Temp		-40 °C to +90 °C		-50 °C to +165 °C	-20 °C to +80 °C	-40 °C to +200 °C	-55 °C to +165 °C		-50 °C to +90 °C	-50 °C to +165 °C	-30 °C to +75 °C		-20 °C to +75 °C	-30 °C to +75 °C	-20 °C to +105 °C		
Bend Radius	Min	5.00 mm	6.80 mm	10.20 mm	25.40 mm	3.18 mm	12.80 mm	12.80 mm	49.50 mm	10.20 mm	38.10 mm	41.00 mm	69.85 mm	70.00 mm	69.85 mm	19.05 mm	
Connector Options		MHF1, MHF3, MHF4	MHF1, SMA	MMCX, MCX, SMA, SMB, BNC, TNC, N Type	MMCX, MMCXV, MCX, SMA, SMB, BNC, TNC, N Type, Ganged	IsoRate [®]	MMCX, MMCXV, MCX, SMA, SMB, BNC, TNC, N Type, Ganged	MMCX, MCX, SMA, SMB, BNC, TNC	SMA, TNC, N Type	MCX, MMCX7, SMB, BNC, DIN 1.0/2.3, Ganged	HD-BNC, DIN 1.0/2.3		BNC, HD-BNC, DIN 1.0/2.3		CJT		

[†] ALSO USES RG 316

50 Ω MICRO HIGH FREQUENCY RF CABLES TO 6 GHz

MHF Cable Assemblies MH081, MH113



SPECIFICATIONS

Outer Contact Material:
Au plated Phosphor Bronze
Center Contact Material:
Au plated Phosphor Bronze (MHX)
Au plated BeCu (SMA)
Insulator Material:
PBT (MHX)
PTFE (SMA)
Operating Temperature:
-40 °C to +90 °C
Voltage Rating:
170 V max
Dielectric Withstanding Voltage:
200 Vrms

0.81 mm Cable:
Capacitance:
100 pF/meter
Max Attenuation (cable only):
3.1 dB @ 1 GHz
Conductor Size:
36 AWG, (0.81 mm) .032" dia.
Conductor Material:
Silver Plated Copper
Conductor Resistance:
1.40 Ω/meter max
Insulator Diameter:
(0.4 mm) .016"
Insulator Material: FEP
Shield Material:
Silver Plated Copper
Jacket Material: PFA
Jacket Diameter:
(0.81 mm) .032" dia.
Bend Radius: 5.0 mm
Jacket Temp Rating:
-40 °C to +90 °C

1.13 mm Cable:
Capacitance:
95 pF/meter
Max Attenuation (cable only):
2 dB @ 1 GHz
Conductor Size:
32 AWG, (1.13 mm) .045" dia.
Conductor Material:
Silver Plated Copper
Conductor Resistance:
0.60 Ω/meter max
Insulator Diameter:
(0.66 mm) .026"
Insulator Material:
FEP
Shield Material:
Tinned Copper
Jacket Material:
FEP
Jacket Diameter:
(1.13 mm) .045" dia
Bend Radius:
6.8 mm
Jacket Temp Rating:
-40 °C to +90 °C

SERIES	END 1 CONNECTOR	END 2 CONNECTOR	OVERALL LENGTH
--------	-----------------	-----------------	----------------

MH081
= 0.81 mm Cable
MH113
= 1.13 mm Cable

Specify END OPTIONS from chart

-0030
= 1.18" (30 mm)
-0050
= 1.97" (50 mm)
-0100
= 3.94" (100 mm)
-0150
= 5.91" (150 mm)
-0300
= 11.81" (300 mm)

APPLICATION

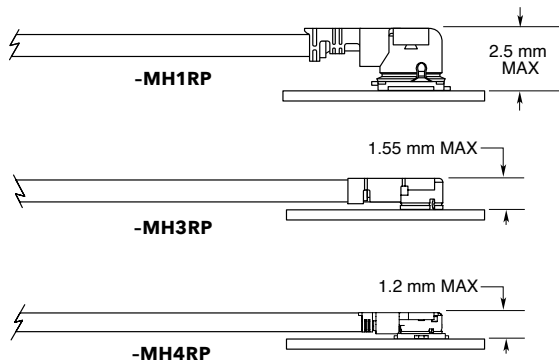

EXTRACTION TOOLS

MH1RP = RSP-122893-01
MH3RP = RSP-122893-02
MH4RP = RSP-122893-03

MATING SOLUTIONS

MH1RP end mates with RSP-122811-01 (Cycles: 30 max.)

MH3RP end mates with RSP-122811-02

MH4RP end mates with RSP-122811-03

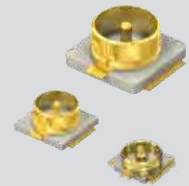

END OPTIONS

-MH1RP = MHF1 Type Plug (3.9 μ" (0.1 μm) Gold on Center Contact, 1.9 μ" (0.05 μm) Gold on Shell)	
-MH3RP = MHF3 Type Plug (3.9 μ" (0.1 μm) Gold on Center Contact, 1.9 μ" (0.05 μm) Gold on Shell) (MH081 only)	
-MH4RP = MHF4 Type Plug (10 μ" (0.25 μm) Gold on Center Contact, 1.9 μ" (0.05 μm) Gold on Shell) (MH4RP is not available with MH1RP & MH3RP) (MH081 only)	
-01BJ1 = SMA Straight Bulkhead Jack (MH081 only) -01BJ2 = SMA Straight Bulkhead Jack, Reversed Polarity -01SB1 = SMA Straight Jack, Sealed Bulkhead -01SR1 = SMA Straight Jack, Sealed Bulkhead, Reversed Polarity (30 μ" (0.76 μm) Gold on Center Contact, Gold Flash on Shell)	
-SING = Single Ended (End 2 callout)	
XXXXXX = Stripped & Tinned (End 2 callout)	

STRIPPED & TINNED (Dimensions in mm)

CALLOUT	A	B	C
-303030	3.0	3.0	3.0
-303040	3.0	3.0	4.0
-403030	4.0	3.0	3.0
-403040	4.0	3.0	4.0
-404040	4.0	4.0	4.0

Both center conductor and braid shield are stripped, only the center conductor is tinned.

50 Ω SMA TO 6 GHz

SMA Cable Assemblies

RF174, RF178, RF316, RS316, RF058



SERIES	END 1 CONNECTOR	END 2 CONNECTOR	OVERALL LENGTH
RF174 = RG 174 Cable	-01SP1 = SMA Straight Plug		-"XXXX" = Overall Length in millimeters
RF178 = RG 178 Cable (-01BJ1 & -01BR1 only)	-01RP1 = SMA Right-angle Plug		-0100 (100 mm) 3.94" minimum
RF316 = RG 316 Cable, Single Braid Shield	-01BJ1 = SMA Straight Bulkhead Jack		
RS316 = RG 316 Cable, Double Shield (-01SP1 & -01BJ1 only)	-01SB1 = Straight Bulkhead Jack, Sealed		
RF058 = RG 58 Cable (-01SP1, -01BJ1 & -01SB1 only)	-01SR1 = Straight Bulkhead Jack, Sealed, Reversed Polarity		
	-01BR1 = Straight Bulkhead Jack, Reversed Polarity		
	-01PN1 = 4-Hole Panel Mount Jack		

ALSO AVAILABLE

50 Ω: MCX, MMCX, SMB, BNC, TNC,
N Type = RF174, RF178, RF316

50 Ω: MCX, MMCX, BNC, TNC = RS316

50 Ω: TNC = RF058

SMA Cable Connectors

SMA-CA



Supplied with pins, washers, nuts and ferrules. See website for dimensions.

SMA	GENDER	TYPE	PLATING	ORIENTATION	TERMINATION	PACKAGING	
	-J = Jack	-C = Cable -C4 = Cable 4-Mounting Screws (-PN1 only)	-H = 30 μ" (0.76 μm) Gold center contact, 3 μ" (0.08 μm) Gold outer contact (N/A with -BH1S)	-ST = Straight	-BH1 = Bulkhead RG 174 / 316 Cable -BH2 = Bulkhead RG 178 Cable -BR1 = Bulkhead RG 174 / 316, Reversed Polarity -BR2 = Bulkhead RG 178 Cable, Reversed Polarity	-BH1S = Bulkhead RG 316 Cable, Double Shield -B10 = Bulkhead RG 58 Cable -PN1 = 4-Hole Panel Mount RG 174 / 316 Cable -S10 = Sealed Bulkhead RG 58 Cable	Leave blank for individually bagged. -B = Bulk packaged (-BH1 only)
			-HF = 30 μ" (0.76 μm) Gold center contact, 3 μ" (0.08 μm) Gold outer contact (-BH1S only)				

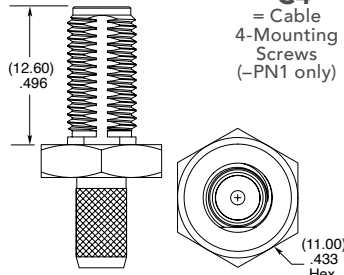

-S10, -B10



SMA Board Connectors

See page 154 for Board Connectors

SMA	GENDER	TYPE	PLATING	ORIENTATION	TERMINATION	PACKAGING
	-P = Plug	-C = Cable	-H = 30 μ" (0.76 μm) Gold center contact, 3 μ" (0.08 μm) Gold outer contact (-CA1, -C10 only)	-ST = Straight -RA = Right-angle	-CA1 = RG 174 / 316 Cable -C10 = RG 58 Cable (-ST only) -CA1S = RG 316 Double Shielded Cable (-ST only)	Leave blank for individually bagged. -B = Bulk packaged (-CA1 only)
			-HF = 30 μ" (0.76 μm) Gold center contact, 3 μ" (0.08 μm) Gold outer contact (-CA1S only)			

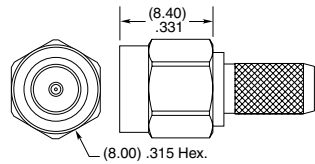

-ST-C10

Supplied with pins, washers, nuts and ferrules. See website for dimensions.

50 Ω MCX TO 6 GHz

MCX Cable Assemblies

RF174, RF178, RF316, RS316



SERIES	END 1 CONNECTOR	END 2 CONNECTOR	OVERALL LENGTH
RF174 = RG 174 Cable	-02SJ1 = MCX Straight Jack		-“XXXX” = Overall Length in millimeters
RF178 = RG 178 Cable	-02RP1 = MCX Right-angle Plug (RS316 not available)		-0100 (100 mm) 3.94" minimum
RF316 = RG 316 Cable, Single Braid Shield	-02SP1 = MCX Straight Plug		
RS316 = RG 316 Cable, Double Shielded			

ALSO AVAILABLE

50 Ω: MMCX, SMA, SMB, BNC, TNC,

N Type = RF174, RF178, RF316

50 Ω: MMCX, SMA, BNC, TNC = RS316

MCX Board Connectors

MCX-TH, MCX-SM, MCX-EM, MCX-MT

Cable Mates:

RF174, RF178, RF316, RS316, GRF1H-C, IJ5H



MCX	GENDER	TYPE	PLATING	ORIENTATION	TERMINATION
	-J = Jack	-P = PCB Mount	-H = 30 μ" (0.76 μm) Gold center contact, 3 μ" (0.08 μm) Gold outer contact	-ST = Straight	-TH1 = Through-hole (-ST plug not available)
	-P = Plug			-RA = Right-angle	-TH2 = Elevated Through-hole (-ST plug only)
					-SM1 = Surface Mount (Jack only)
					-EM1 = Edge Mount (-ST jack only)
					-MT1 = Mixed Technology (-ST jack only)

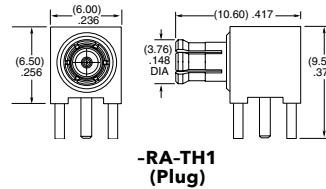
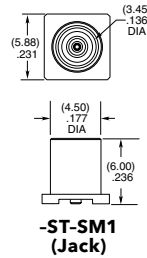

MCX Cable Connectors

MCX-CA



CONNECTORS FOR INDUSTRY STANDARD CABLES	
MCX-J-C-H-ST-CA1	RG 174/316 Cable
*MCX-J-C-H-ST-CA2	RG 178 Cable
MCX-J-C-HF-ST-CA1S	RG 316 Double Shielded Cable
*MCX-P-C-H-ST-CA1	RG 174/316 Cable
MCX-P-C-H-ST-CA2	RG 178 Cable
MCX-P-C-HF-ST-CA1S	RG 316 Double Shielded Cable
*MCX-P-C-H-RA-CA1	RG 174/316 Cable
MCX-P-C-H-RA-CA2	RG 178 Cable

P-C = Cable Plug
J-C = Cable Jack
H or HF = Plating (30 μ" Gold center contact, 3 μ" Gold outer contact)
ST = Straight
RA = Right-angle

*Add "-B" to the end of the part number for bulk packaging

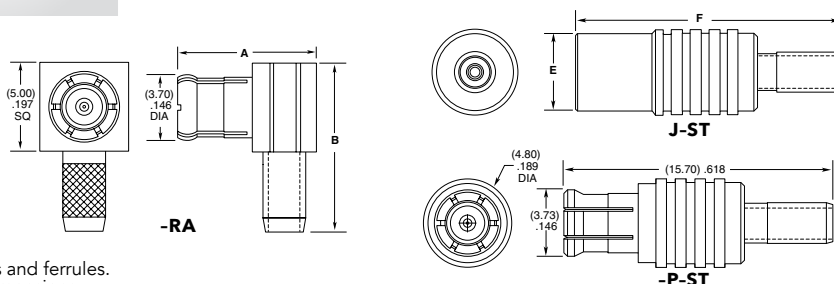

Supplied with pins and ferrules. See website for dimensions.

TYPE (-RA)	A	B
-P-CA1	(7.78) .306	(9.50) .374
-P-CA2	(8.58) .338	(10.00) .394

TYPE (-ST)	E	F
-J-CA1	(4.50) .177	(15.50) .610
-J-CA2	(4.78) .188	(15.00) .591
-J-CA1S	(4.50) .177	(15.50) .610

50 Ω MMCX TO 6 GHz

MMCX Cable Assemblies

RF174, RF178, RF316, RS316



SERIES	END 1 CONNECTOR	END 2 CONNECTOR	OVERALL LENGTH
RF174 = RG 174 Cable	-03SP1 = MMCX Straight Plug		-“XXXX” = Overall Length in millimeters -0100 (100 mm) 3.94" minimum
RF178 = RG 178 Cable (-03SP1 & -03RP1 only)	-03RP1 = MMCX Right-angle Plug		
RF316 = RG 316 Cable, Single Braid Shield	-V3SP1 = MMCXV Straight Plug, High Vibration		
RS316 = RG 316 Cable, Double Shielded (-03SP1 only)	-V3RP1 = MMCXV Right-angle Plug, High Vibration		
		-V3SJ1 = MMCXV Straight Jack, High Vibration	

ALSO AVAILABLE

50 Ω: MCX, SMA, SMB, BNC, TNC,
N Type = RF174, RF178, RF316

50 Ω: MCX, SMA, BNC, TNC = RS316

MMCX Board Connectors

MMCX-SM, MMCX-TH, MMCX-MT, MMCX-EM

Cable Mates:
RF174, RF178, RF316, RS316,
GRF1H-C, IJ5H



MMCX	GENDER	TYPE	PLATING	ORIENTATION	TERMINATION
	-J = Jack	-P = PCB Mount	-H = 30 μm (0.76 μm) Gold center contact, 3 μm (0.08 μm) Gold outer contact	-ST = Straight -RA = Right-angle	-TH1 = Through-hole -MT1 = Mixed Technology (-ST only) -SM1 = Surface Mount (-RA plug not available) -EM1 = Edge Mount (-ST only)

-ST-SM1 (Jack)

-RA-TH1 (Plug)

MMCX Cable Connectors

MMCX-CA



CONNECTORS FOR INDUSTRY STANDARD CABLES	
MMCX-P-C-H-ST-CA1	RG 174/316 Cable
MMCX-P-C-H-ST-CA2	RG 178 Cable
MMCX-P-C-HF-ST-CA1S	RG 316 Double Shielded Cable
MMCX-P-C-H-RA-CA1	RG 174/316 Cable
MMCX-P-C-H-RA-CA2	RG 178 Cable

Add "-B" to the end of the part number for bulk packaging
P-C = Cable Plug
H or HF = Plating (30 μm Gold center contact,
3 μm Gold outer contact)
ST = Straight
RA = Right-angle

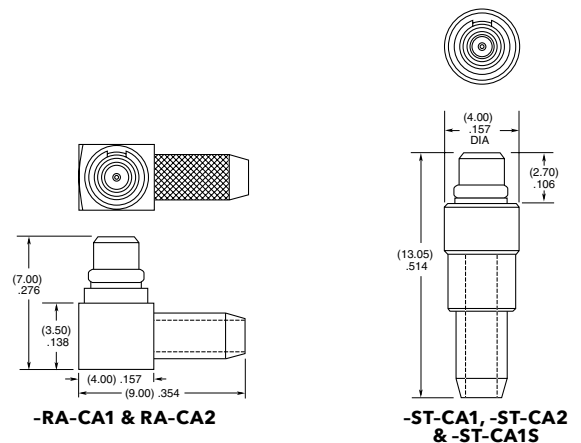

Supplied with pins and ferrules.
See website for dimensions.

50 Ω TNC TO 6 GHz

TNC Cable Assemblies

RF174, RF178, RF316, RS316, RF058



SERIES	END 1 CONNECTOR	END 2 CONNECTOR	OVERALL LENGTH
RF174 = RG 174 Cable	-05SP3 = TNC Straight Plug (RF058 not available)	-05BJ3 = TNC Straight Bulkhead Jack (RS316 & RF058 not available)	-“XXXX” = Overall Length in millimeters -0100 (100 mm) 3.94" minimum
RF178 = RG 178 Cable			
RF316 = RG 316 Cable, Single Braid Shield			
RS316 = RG 316 Cable, Double Shielded			
RF058 = RG 58 Cable			

ALSO AVAILABLE

50 Ω: MCX, MMCX, SMA, SMB, BNC,
N Type = RF174, RF178, RF316

50 Ω: MCX, MMCX, SMA, BNC = RS316

50 Ω: SMA, N Type = RF058

TNC Board Connectors

TNC-TH

Cable Mates:

RF174, RF178, RF316, RS316, RF058, GRF1H-C

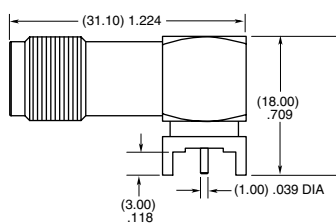

TNC	GENDER	TYPE	PLATING	ORIENTATION	TERMINATION
	-J = Jack	-P = PCB Mount	-H = 30 μ" (0.76 μm) Gold center contact, Nickel on shell	-RA = Right-angle	-TH1 = Through-hole

TNC Cable Connectors

TNC-CA



CONNECTORS FOR INDUSTRY STANDARD CABLES	
TNC-P-C-GN-ST-CA1	RG 174/316 Cable
TNC-P-C-GN-ST-CA2	RG 178 Cable
TNC-P-C-GN-SR-C10	RG 58 Cable
TNC-J-C-GN-ST-BH1	RG 174/316 Cable, Bulkhead
TNC-J-C-GN-ST-BH2	RG 178 Cable, Bulkhead

P-C = Cable Plug
J-C = Cable Jack
GN = Plating (10 μ" Gold on contact, Nickel on body)
ST = Straight
SR = Straight Reverse Polarity

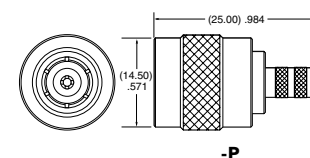
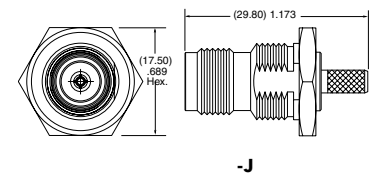

Supplied with pins, washers, nuts and ferrules. See website for dimensions.

50 Ω BNC TO 4 GHz

BNC Cable Assemblies

RF174, RF178, RF316, RS316



SERIES	END 1 CONNECTOR	END 2 CONNECTOR	OVERALL LENGTH
RF174 = RG 174 Cable	-04SP3 = BNC Straight Plug (RS316 not available)	-04BJ2 = BNC Bulkhead Jack	-"XXXX" = Overall Length in millimeters -0100 (100 mm) 3.94" minimum
RF178 = RG 178 Cable			
RF316 = RG 316 Cable, Single Braid Shield			
RS316 = RG 316 Cable, Double Shielded			
ALSO AVAILABLE			
50 Ω: MCX, MMCX, SMA, SMB, TNC, N Type = RF174, RF178, RF316			
50 Ω: MCX, MMCX, SMA, TNC = RS316			

BNC Cable Connectors

BNC5-CA



Supplied with pins, washers, nuts, gaskets and ferrules. See website for dimensions.

CONNECTORS FOR INDUSTRY STANDARD CABLES	
*BNC5-P-C-GN-ST-CA1	RG 174/316 Cable
*BNC5-P-C-GN-ST-CA2	RG 178 Cable
*BNC5-J-C-GN-ST-BH1	RG 174/316 Cable, Bulkhead
BNC5-J-C-GN-ST-BH2	RG 178 Cable, Bulkhead
BNC5-J-C-GN-ST-BH1S	RG 316 Double Shielded Cable, Bulkhead

*Add "-B" to the end of the part number for bulk packaging

P-C = Cable Plug

J-C = Cable Jack

GN = Plating (10 μ" Gold on contact, Nickel on body)

ST = Straight

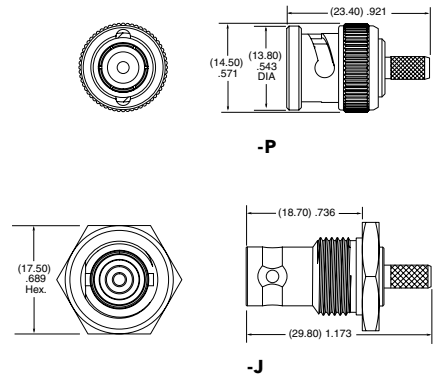

50 Ω SMB TO 4 GHz

SMB Cable Assemblies

RF174, RF178, RF316



SERIES	END 1 CONNECTOR	END 2 CONNECTOR	OVERALL LENGTH
RF174 = RG 174 Cable	-07SP1 = SMB Straight Plug		-“XXXX” = Overall Length in millimeters
RF178 = RG 178 Cable	-07RP1 = SMB Right-angle Plug		-0100 (100 mm) 3.94" minimum
RF316 = RG 316 Cable, Single Braid Shield	-07BJ1 = SMB Bulkhead Jack		
	-07BJ2 = SMB Bulkhead Jack (RF178 only)		

ALSO AVAILABLE

50 Ω: MCX, MMCX, SMA, BNC, TNC,
N Type = RF174, RF178, RF316

SMB Board Connectors

SMB5-TH

Cable Mates:
RF174, RF178, RF316,
GRF1H-C, IJ5H

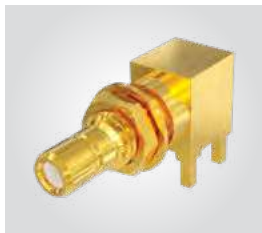

SMB5	GENDER	TYPE	PLATING	ORIENTATION	TERMINATION
	-J = Jack	-P = PCB Mount	-H = 30 μ" (0.76 μm) Gold center contact, 3 μ" (0.08 μm) Gold outer contact	-RA = Right-angle	-TH1 = Through-hole

(10.92)
.430

(20.45) .805

SMB Cable Connectors

SMB5-CA



CONNECTORS FOR INDUSTRY STANDARD CABLES	
SMB5-P-C-H-ST-CA1	RG 174/316 Cable
SMB5-P-C-H-RA-CA1	RG 174/316 Cable
SMB5-J-C-H-ST-CA2	RG 178 Cable
SMB5-J-C-H-ST-BH1	RG 316 Cable, Bulkhead

P-C = Cable Plug
J-C = Cable Jack
H = Plating (30 μ" Gold center contact, 3 μ" Gold on outer contact)
ST = Straight
RA = Right-angle

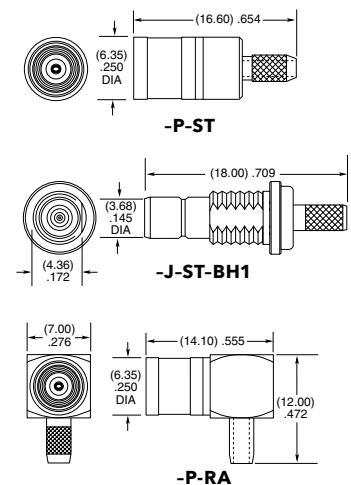

Supplied with pins, washers, nuts and ferrules. See website for dimensions.



75 Ω BNC TO 12 GHz

BNC Cable Assemblies

RFC6T, RFA6T, RFB6T, RF179



SERIES	END 1 CONNECTOR	END 2 CONNECTOR	OVERALL LENGTH
RFC6T* = 12G-SDI, Belden 4694R Cable		-74SP3 = 75 Ω BNC Straight Plug	-“XXXX” = Overall Length in millimeters -0300 (300 mm) 11.81" minimum (RFA6T, RFB6T, RFC6T) -0100 (100 mm) 3.94" minimum (RF179)
RFA6T = RG 6 Cable		-D4SP3 = 75 Ω BNC Die Cast Straight Plug (RFA6T, RFB6T, RF179 only)	
RFB6T = Belden 1694A Cable		-74BJ3 = 75 Ω BNC Bulkhead Jack (RF179 only)	
RF179 = RG 179 Cable		-74RP3 = 75 Ω BNC Right-angle Plug (RFA6T, RFB6T, RFC6T only)	

ALSO AVAILABLE

75 Ω: DIN 1.0/2.3, HDBNC = RFA6T, RFB6T, RFC6T

75 Ω: DIN 1.0/2.3, SMB, MCX, MMCX = RF179

*Designed to meet SMPTE 2082 12G-SDI specifications.

BNC Cable Connectors

BNC7T-CA



Supplied with pins, washers, nuts, gaskets and ferrules. See website for dimensions.

CONNECTORS FOR INDUSTRY STANDARD CABLES	
**BNC7T-P-C-GN-ST-CA3	Machined, RG 179 Cable
**BNC7T-P-C-GN-RA-CA3	Machined, RG 179 Cable
**BNC7T-P-C-GN-ST-CA6	*Machined, RG 6 Cable
**BNC7T-P-C-GN-RA-CA6	*Machined, RG 6 Cable
**BNC7T-P-C-GN-ST-CA6B	Belden 4694R Cable
**BNC7T-P-C-GN-RA-CA6B	Belden 4694R Cable
**BNC7T-J-C-GN-ST-BH3	Machined, Bulkhead, RG 179 Cable
BNC7T-P-C-GN-ST-CA3D	Die Cast, RG 179 Cable
BNC7T-P-C-GN-ST-CA6D	Die Cast, RG 179 Cable

P-C = Cable Plug
J-C = Cable Jack
GN = Plating (10 μ" Gold on contact, Nickel on outer contact and shell)
ST = Straight
RA = Right-angle

**Add "-B" to the end of the part number for bulk packaging

*Designed to meet SMPTE 2082 12G-SDI specifications.

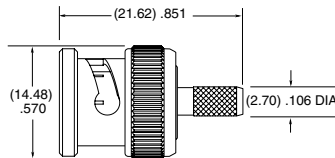

-CA3D

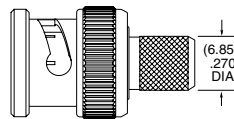

-CA6D

DIE CAST

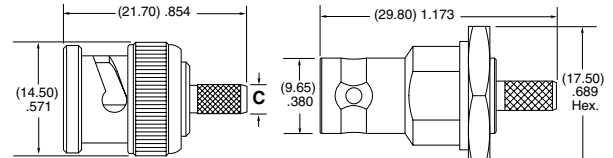

-P-ST-CA3 & -P-ST-CA6

-J-ST-BH3

MACHINED

Note:
Additional plating options available on Cable Assemblies, Cable Connectors and Board Connectors. Contact RFGroup@samtec.com

TERMINATION	C (DIA)
-CA3	(2.70) .106
-CA6	(6.85) .207

75 Ω DIE CAST BNC TO 12 GHz

BNC Board Connectors
BNC7T-TH, BNC7T-BH,
BNC7T-BM, BNC7T-EM

Cable Mates:
RF179, RFA6T, RFB6T,
RFC6T, GRF7H-C



BNC7T	GENDER	TYPE	PLATING	ORIENTATION	TERMINATION	PACKAGING
	-J = Jack	-P = PCB Mount	-GN = 10 μ" (0.25 μm) Gold contact, 100 μ" (2.54 μm) Nickel Shell	-ST = Straight -RA = Right-angle Bulkhead/Panel Mount	-TH2D = Tall Through-hole Die Cast (-ST only) -BH2D* = Low Profile Die Cast Bulkhead Through-hole (-RA only) -BM1D* = Low Profile Die Cast Bulkhead Mixed Technology for (1.60 mm) .062" PCB (-RA only) -BM2D* = Low Profile Die Cast Bulkhead Mixed Technology for (3.18 mm) .125" PCB (-RA only) -EM1D* = Edge Mount Die Cast Bulkhead/Panel Mount for (1.60 mm) .062" PCB (-ST only) -EM2D* = Edge Mount Die Cast Bulkhead/Panel Mount for (2.40 mm) .093" PCB (-ST only)	Leave blank for individually bagged. -B = Bulk packaged (-BH2D only)

Notes:
Contact RFGroup@samtec.com for 12G-SDI PCB mount launch characteristics.

Designed to meet SMPTE 2082 12G-SDI specifications.

Additional plating options available on Board Connectors. Contact RFGroup@samtec.com

*Lock washers & knurled nuts supplied with bulkhead/panel mount options

75 Ω MACHINED BNC TO 12 GHz

BNC Board Connectors
BNC7T-TH, BNC7T-BH,
BNC7T-EM

Cable Mates:
RF179, RFA6T, RFB6T,
RFC6T, GRF7H-C



BNC7T	GENDER	TYPE	PLATING	ORIENTATION	TERMINATION	PACKAGING
	-J = Jack	-P = PCB Mount	-GN = 10 μ" (0.25 μm) Gold contact, 100 μ" (2.54 μm) Nickel Shell	-ST = Straight -RA = Right-angle Bulkhead/Panel Mount	-TH1 = Standard Through-hole (-ST only) -BH1* = Standard Bulkhead Through-hole (-RA only) -EM1* = Edge Mount Bulkhead/Panel Mount for (1.60 mm) .062" PCB (-ST only) -EM2* = Edge Mount Bulkhead/Panel Mount for (2.40 mm) .093" PCB (-ST only)	Leave blank for individually bagged. -B = Bulk packaged (-BH1 only)

Notes:
Contact RFGroup@samtec.com for 12G-SDI PCB mount launch characteristics.

Designed to meet SMPTE 2082 12G-SDI specifications.

Additional plating options available on Board Connectors. Contact RFGroup@samtec.com

*Lock washers & knurled nuts supplied with bulkhead/panel mount options

75 Ω HIGH-DENSITY BNC TO 12 GHz

HIGH-DENSITY BNC Cable Assemblies

RFA6T, RFB6T, RFB8T, RFC6T, RFC8T



SERIES	END 1 CONNECTOR	END 2 CONNECTOR	OVERALL LENGTH
RFC6T* = 12G-SDI, Belden 4694R Cable RFC8T* = 12G-SDI, Belden 4855R Cable RFA6T = RG 6 Cable RFB6T = Belden 1694A Cable RFB8T = Belden 1855A Cable		-H4SP3 = 75 Ω High-Density BNC Straight Plug	-"XXXX" = Overall Length in millimeters -0300 (300 mm) 11.81" minimum

ALSO AVAILABLE

75 Ω: DIN 1.0/2.3, BNC = RFB6T, RFA6T, RFC6T

75 Ω: DIN 1.0/2.3 = RFB8T, RFC8T

*Designed to meet SMPTE 2082 12G-SDI specifications.

HIGH-DENSITY BNC Board Connectors

HDBNC-TH, HDBNC-EM, HDBNC-BH, HDBNC-BM

Cable Mates:

RFA6T, RFB6T, RFB8T, RFC6T, RFC8T



HDBNC	GENDER	TYPE	PLATING	ORIENTATION	TERMINATION	PACKAGING
	-J = Jack	-P = PCB Mount	-GN = 10 μ" (0.25 μm) Gold contact, 100 μ" (2.54 μm) Nickel shell	-ST = Straight -RA = Right-angle	-BH1 = Through-hole -BH2 = Through-hole (2.36 mm) .093" PCB (-RA only) -BM1D = Die Cast Bulkhead Mixed Technology for (1.60 mm) .062" PCB (-RA only) -BM2D = Die Cast Bulkhead Mixed Technology for (3.18 mm) .125" PCB (-RA only) -EM1 = Edge Mount (-ST only) -TH1 = Through-hole, Three Legs (-ST only)	Leave blank for individually bagged. -B Bulk packaged (-BHX only)

-RA-BH2

-ST-EM1

-RA-BM1D & -BM2D (BALANCED FOR PICK-AND-PLACE)

-ST-BH1

-ST-TH1

Notes:

Designed to meet SMPTE 2082 12G-SDI specifications.

Additional plating options available on Cable Assemblies, Cable Connectors and Board Connectors. Contact RFGroup@samtec.com

HIGH-DENSITY BNC Cable Connectors

HDBNC-CA



CONNECTORS FOR INDUSTRY STANDARD CABLES	
HDBNC-P-C-GN-ST-CA6	RG 6, Belden 1694A or Belden 4694R Cable
HDBNC-P-C-GN-ST-CA8	Belden 1855A or Belden 4855R Cable

Add "-B" to the end of the part number for bulk packaging (100 max.)

P-C = Cable Plug

GN = Plating (10 μ" Gold on contact, Nickel on outer contact & shell)

ST = Straight

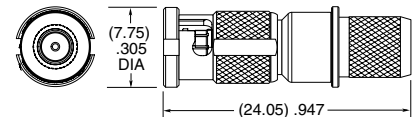

-CA6

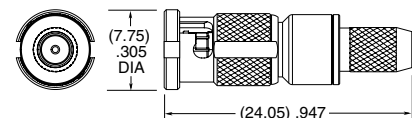

-CA8

Supplied with pins and ferrules. See website with dimensions.

Designed to meet SMPTE 2082 12G-SDI specifications.

DIN Cable Assemblies

RFA6T, RFB6T, RF179, RFB8T, RFC6T, RFC8T



SERIES	END 1 CONNECTOR	END 2 CONNECTOR	OVERALL LENGTH
RFC6T* = 12G-SDI, Belden 4694R Cable RFC8T* = 12G-SDI, Belden 4855R Cable RFA6T = RG 6 Cable RFB6T = Belden 1694A Cable RF179 = RG 179 Cable RFB8T = Belden 1855A Cable	-78SP4 = 75 Ω DIN Straight Plug		-“XXXX” = Overall length in millimeters -0100 (100 mm) 3.94" minimum (RF179) -0300 (300 mm) 11.81" minimum (RFA6T, RFB6T, RFB8T, RFC6T, RFC8T)
ALSO AVAILABLE 75 Ω: HDBNC, BNC = RFB6T, RFA6T, RFC6T 75 Ω: BNC, SMB, MCX, MMCX = RF179 75 Ω: HDBNC = RFB8T, RFC8T			

*Designed to meet SMPTE 2082 12G-SDI specifications.

DIN Board Connectors

DIN7A-TH, DIN7A-BH

Cable Mates:

RFA6T, RFB6T, RF179, RFB8T, RFC6T, RFC8T, GRF7H-C



DIN7A	GENDER	TYPE	PLATING	ORIENTATION	TERMINATION	PACKAGING
	-J = Jack	-P = PCB Mount	-GF = 10 μ" (0.25 μm) Gold center contact, 3 μ" (0.08 μm) Gold outer contact, 100 μ" (2.54 μm) Nickel body -RA only)	-ST = Straight (-TH1 only) -RA = Right-angle (-BH1 only)	-TH1 = Through-hole (-ST only) -BH1 = Bulkhead Through-hole (-RA only)	Leave blank for individually bagged. -B = Bulk packaged (-BH1 only)
			-ST-TH1	NUT	-RA-BH1	

Notes:

Contact RFGroup@samtec.com for 12G-SDI PCB mount launch characteristics.

Designed to meet SMPTE 2082 12G-SDI specifications.

Additional plating options available on Cable Assemblies, Cable Connectors and Board Connectors. Contact RFGroup@samtec.com

DIN Cable Connectors

DIN7A-CA



CONNECTORS FOR INDUSTRY STANDARD CABLES	
DIN7A-PP-C-GF-ST-CA3	RG 179
DIN7A-PP-C-GF-ST-CA6	*RG 6, Belden 1694A or Belden 4694R Cable
DIN7A-PP-C-GF-ST-CA8	*Belden 1855A or Belden 4855R Cable

Add "-B" to the end of the part number for bulk packaging (100 max.)

*Designed to meet SMPTE 2082 12G-SDI specifications.

PP-C = Push Pull Plug Cable

GF = Plating (10 μ" Gold on center contact, Flash Gold on outer contact, Nickel on Shell)

ST = Straight

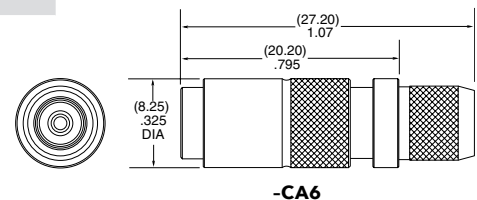

-CA6

Supplied with pins and ferrules. See website for dimensions

75 Ω SMB TO 4 GHz

SMB Cable Connectors RF179



SERIES	END 1 CONNECTOR	END 2 CONNECTOR	OVERALL LENGTH
--------	-----------------	-----------------	----------------

RF179
= RG 179 Cable

-77SP1
= 75 Ω SMB Straight Plug

-77RP1
= 75 Ω SMB Right-angle Plug

-“XXXX”
= Overall Length in millimeters
-0100 (100 mm) 3.94" minimum

ALSO AVAILABLE

75 Ω: DIN 1.0/2.3, BNC, MCX, MMCX = RF179

SMB Cable Connectors SMB7H-TH, SMB7H-EM

Cable Mates:
RF179, GRF7H-C



SMB7H	GENDER	TYPE	PLATING	ORIENTATION	TERMINATION
-------	--------	------	---------	-------------	-------------

-J
= Jack

-P
= PCB Mount

-H
= 30 μ" (0.76 μm) Gold center contact,
3 μ" (0.08 μm) Gold outer contact

-ST
= Straight

-RA
= Right-angle

-TH1
= Through-hole ((0.90 mm) .035" DIA Signal Pin)

-TH2
= Through-hole ((0.51 mm) .020" DIA Signal Pin) (-ST only)

-EM1
= Edge Mount (-ST only)

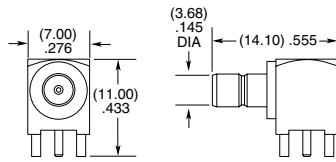

-RA-TH1

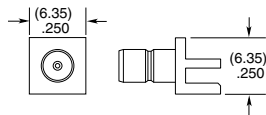

-ST-EM1

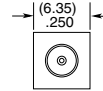

-ST-TH1 & -ST-TH2

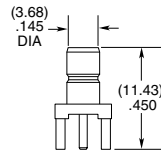

Note:
Additional plating options available on Cable Assemblies, Cable Connectors and Board Connectors. Contact RFGroup@samtec.com

SMB Cable Connectors SMB7H-CA



CONNECTORS FOR INDUSTRY STANDARD CABLES	
SMB7H-P-C-H-ST-CA3	RG 179 Cable
SMB7H-P-C-HF-RA-CA3	RG 179 Cable

P-C = Cable Plug
H or HF = Plating (30 μ" Gold center contact, 3 μ" Gold outer contact)
ST = Straight
RA = Right-angle

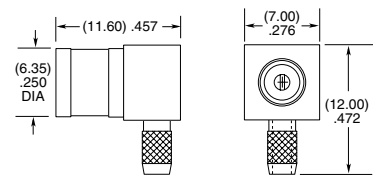

-P-RA

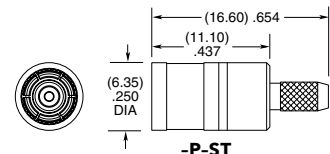

-P-ST

Supplied with pins and ferrules.
See website for dimensions

ORIGINAL SOLUTIONS LOW FREQUENCY RF

SHIELDED TWISTED PAIR SYSTEM

- 100 Ω differential pair
- 28 AWG shielded twisted pair cable assembly
- High reliability BeCu contacts
- 1/4-turn bayonet lock

DC TO
4
GHz

GANGED MICRO-MINI SYSTEMS

- 50 Ω & 75 Ω board stacking and cable assemblies
- High performance rugged contacts
- Variety of End 2 connectors (GRF1H-C, GRF7H-C Series)

DC TO
5
GHz

ISORATE® SYSTEMS

- 50 Ω board stacking and cable assemblies
- Isolated signal systems for 90 percent performance of traditional RF at 50 percent of the cost

DC TO
9.5
GHz

MINI & MICRO-MINI INTERCONNECTS

- 75 Ω impedance (MMCX7 & MCX7 Series)
- Higher extraction forces (MMCXV Series)
- Not intermateable with standard MMCX, MCX

DC TO
6
GHz

HIGH-CYCLE U.FL CABLE PLUG

- 500 cycle U.FL compatible plug (HMHF1 Series)
- .047" DIA flexible cable (RF047 Series)

DC TO
10
GHz

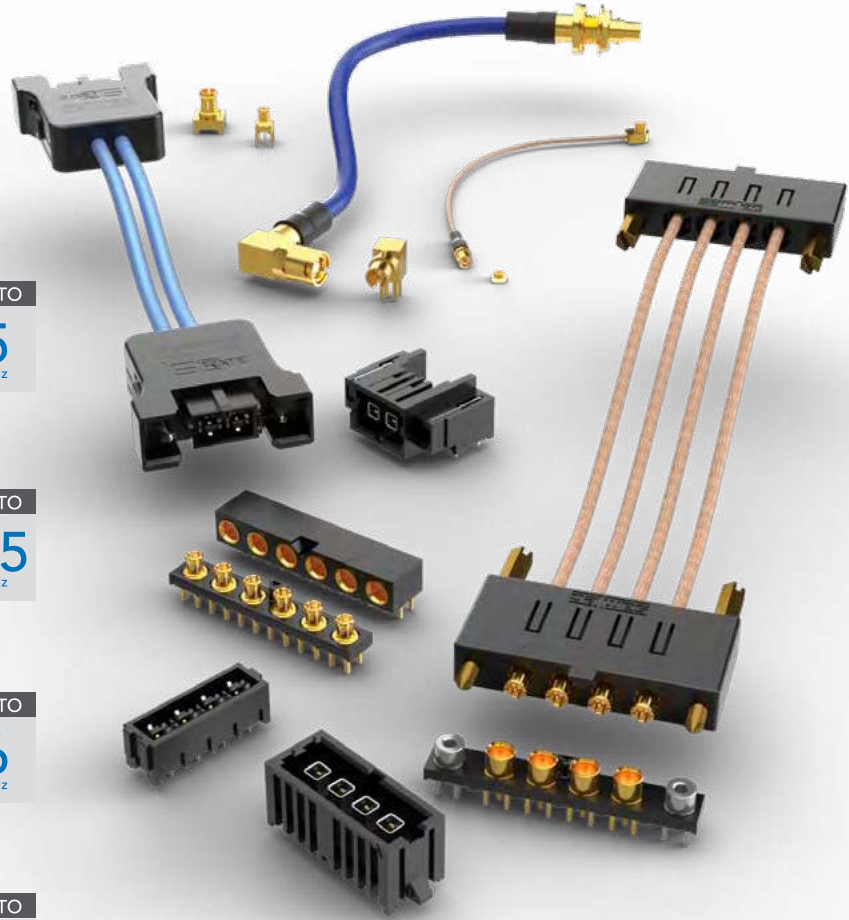

High Frequency Original RF Solutions Available.
See page 147

CABLE SOLUTIONS

SERIES	C28S/CJT	GRF1-C/GRF7-C	GRF1H-C/GRF7H-C	RF047	IJ5C/IJ5H
Application	Shielded Twisted Pair	50 Ω & 75 Ω Micro-Mini Ganged	50 Ω & 75 Ω Micro-Mini Hybrid Ganged	50 Ω .047 DIA Flexible Cable	50 Ω IsoRate®
URL	samtec.com?C28S samtec.com?CJT-BH samtec.com?CJT-TH	samtec.com?GRF1-C samtec.com?GRF7-C	samtec.com?GRF1H-C samtec.com?GRF7H-C	samtec.com?RF047	samtec.com?IJ5C samtec.com?IJ5H

BOARD-TO-BOARD SOLUTIONS

SERIES	GRF1-P/GRF1-J	GRF7-P/GRF7-J	MMCX7	MCX7	MMCXV	IJ5/IP5
Application	50 Ω Micro-Mini Ganged	75 Ω Micro-Mini Ganged	75 Ω Mini and Micro-Mini Interconnects		High-Vibration Micro-Mini	50 Ω IsoRate®
URL	samtec.com?GRF1-P samtec.com?GRF1-J	samtec.com?GRF7-P samtec.com?GRF7-J	samtec.com?MMCX7-TH samtec.com?MMCX7-CA	samtec.com?MCX7 samtec.com?MCX7-CA	samtec.com?MMCXV-TH samtec.com?MMCXV-EM samtec.com?MMCXV-CA	samtec.com?IJ5 samtec.com?IP5

CUSTOM SOLUTIONS & QUICK-TURN MODIFICATIONS

Samtec's fully vertically integrated business model enables the flexibility to quickly and efficiently identify and/or develop innovative, application-specific interconnect solutions to meet a variety of demands in digital/analog systems. Contact RFGroup@samtec.com to discuss your application.

- Termination types
- Custom tail lengths / designs
- Right-angle height adjustment
- Heat-shrink tubing
- High frequency applications
- Pick & Place machine designs
- Counterweights for automated assembly (eliminate hand-soldering)
- Alternate platings
- Custom labels
- Test & Measurement solutions



TECHNICAL SUPPORT, SI & RF DESIGN EXPERTISE

Samtec's Signal Integrity / RF Design & Simulation Engineers provide personal support for solving complex system challenges. In addition, a variety of resources are available online which help answer questions specific to microwave / millimeter wave system design.

- Launch optimization & design services
- Simulation
- Prototyping
- Physical test and measurement verification
- Full channel analysis, system support
- Specific design and development application assistance

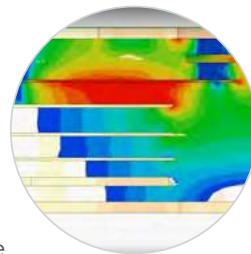

E-field Simulation

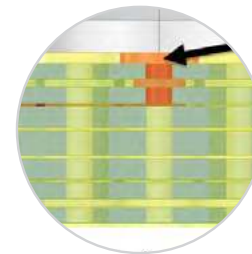

3D Modeling

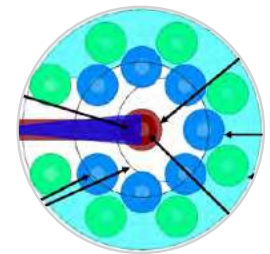

Launch Optimization

TECHNICAL RESOURCES

More available on samtec.com

WHITE PAPERS

samtec.com/tech-library

- Wideband RF Launches
- Impacts of Solder Reflow on RF Connectors
- Millimeter Wave Design

TECH REPORT

samtec.com/alignment

- Precision Alignment Features

PRESENTATION

samtec.com/system-impedance

- Understanding Transmission Line Discontinuities

PRECISION RF EVALUATION KITS

samtec.com/kits/rf

- Precision RF
- Bulls Eye®
- Analog Over Array™

ULTRA RUGGED SOLUTIONS

EXTREME HIGH MATING CYCLES • RUGGED MIL-DTL MATERIALS • SEVERE ENVIRONMENT TESTING

185 RUGGED POWER I/O SYSTEMS (B1SD(T)/P1PD(T)/P1M)



URSA I/O
ULTRA RUGGED CONTACT SYSTEM

185 38999 RUGGED I/O SYSTEMS (NVA3E/NVA3P)



NOVARAY I/O

186 RUGGED/COMPACT OPTICS (CSPO, CSSO)



FIREHAWK™

186 VITA 90 VNX+ SOLUTIONS (SEARAY™, GPCC, RUGGED OPTICS)



VNX+™

186 EXTREME ENVIRONMENT & EXTENDED TEMP OPTICS (ETMO, ETUO, UEC5/UCC8)

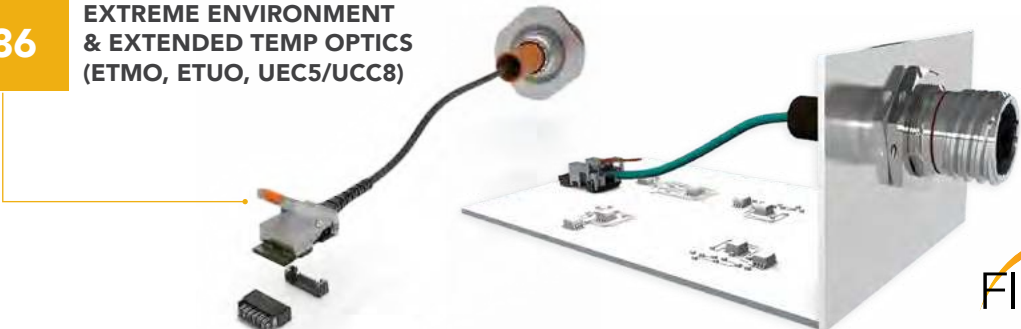

FIREFLY™

ULTRA RUGGED SOLUTIONS



Samtec's ultra rugged solutions provide reliability and flexibility in small form factors for extreme/harsh environments. From rugged I/O cable assemblies, sealed & compact optics, and VITA 90 VNX+ modules to ultra rugged hardware and high-temp coatings, these solutions are ideal for military, aerospace, submersible and other harsh environment applications. Many ultra rugged offerings are available now with a robust roadmap to meet or exceed requirements for harsh environment applications and industries.

For design flexibility and cost optimization, Samtec's Severe Environment Testing (SET) qualified products are Commercial-Off-the-Shelf (COTS) and modified COTS to get solutions to market faster. See page 188-189 or visit [samtec.com/set](https://www.samtec.com/set) for more information.



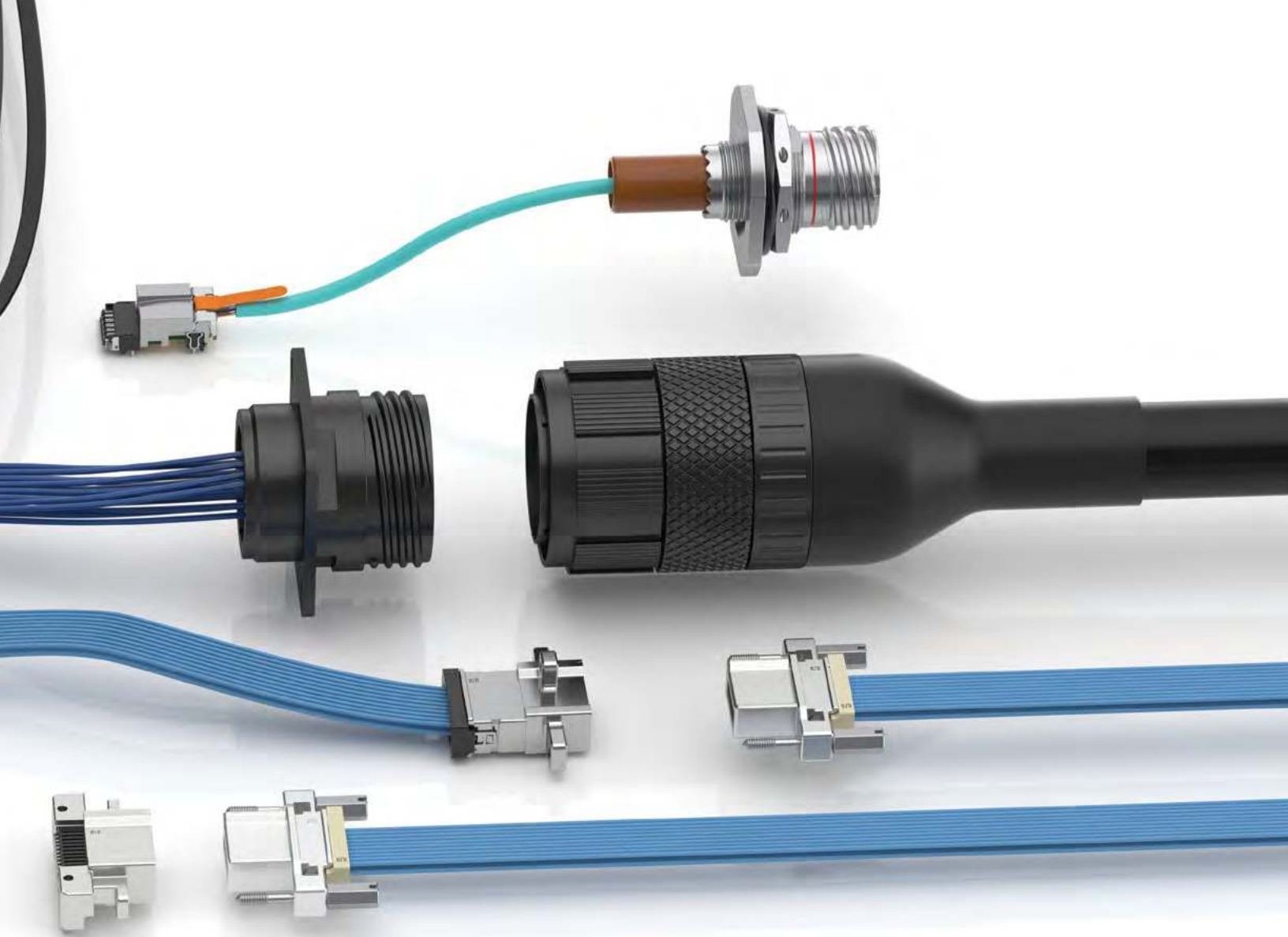

RUGGED POWER I/O SYSTEMS

- Four points of contact for a reliable connection and high mating cycles
- Extreme density with up to 1,450 I/Os in a 1RU panel
- EMI shielding limits signal degradation and optimizes performance
- Series: B1SD(T)/P1PD(T)/P1M
- See page 212-215 for more information
- samtec.com/ursa



38999 RUGGED I/O SYSTEMS

- High data rate cable system in a rugged 38999 shell
- Salt fog resistant to 48 hours; IP67 for dust and waterproof sealing
- Threaded cable-to-panel design
- High-density 16 pair; 32 on roadmap
- Series: NVA3E/NVA3P
- See page 103 for more information
- samtec.com/novaray-io



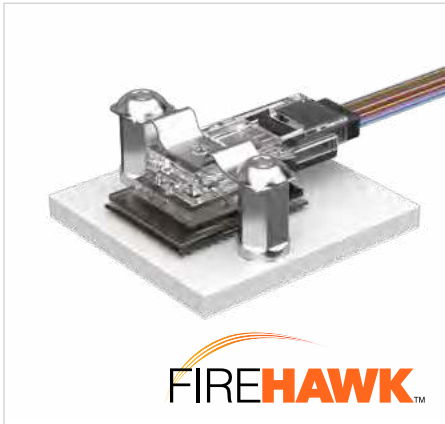

ULTRA RUGGED/COMPACT OPTICS

- FireHawk™ is the smallest optical transceiver in the industry – 10 x 7.7 x 2.5 mm
- Extreme performance up to 40 Gbps transfer rates
- Rugged BGA attach withstands high shock and vibration
- Radiation tolerant design
- Series: CSPO, CSSO
- See page 138 for more information
- samtec.com/firehawk



VITA 90 VNX+ SOLUTIONS

- RF backplane system to support 110 GHz with high-density size 20 cable; size 16 on roadmap
- Rugged blind mate solution
- Configured with SEARAY™ right-angle array and rugged optics
- SWaP-C reductions make this ideal for military and aerospace applications
- COTS or modified COTS solution for cost and time flexibility
- See page 328-329 for more information
- samtec.com/vnx-plus



EXTREME ENVIRONMENT OPTICAL SYSTEM

- Sealed and parylene-coated for exposed military, aerospace and submersible applications
- Ruggedized for tin whisker mitigation and fungal resistance; operates in harsh environments including salt fog, blowing sand and dust, jet fuel exposure, altitudes up to 65,000 feet
- Extended temp range of -40 °C to +85 °C
- Series: ETMO/UEC5/UCC8
- See page 133 for more information
- samtec.com/firefly

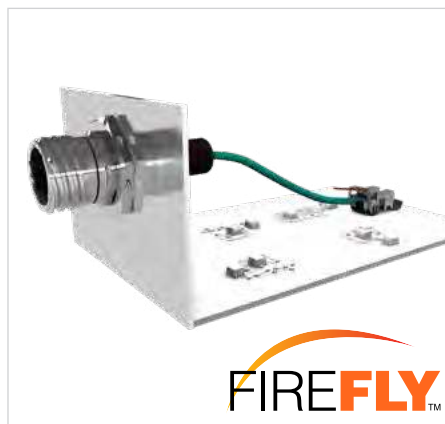

EXTENDED TEMP OPTICAL SYSTEMS

- Extended temperature range from -40 °C to +85 °C
- x4 and x12 designs to 25 Gbps per lane performance
- Samtec's Extended Temp FireFly™ optical with Amphenol® Aerospace bulkhead interconnects
- Micro footprint allows for increased density
- Series: ETUO/UEC5/UCC8
- See page 132 for more information
- samtec.com/firefly





ULTRA RUGGED HARDWARE

- Guide post standoffs (GPSO) allow for .035" of initial misalignment
- Assists with "blind mate" for ultra micro, fine pitch mezzanine connectors
- 5 to 30 mm stack heights
- 303 stainless steel with MIL-C-13924 black oxide finish
- Jack screw precision standoffs (JSO) reduce the risk of component damage
- Standoffs (SO) with precision machined tolerances (+/- .002" (0.05 mm))
- See pages 33-34 and 60 for more information
- samtec.com/hardware

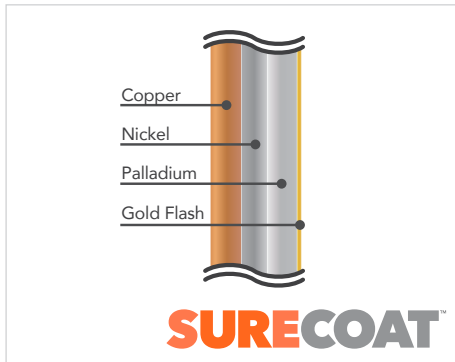

HIGH-RELIABILITY PLATING

- 40 to 50 μ " palladium nickel plating with gold flash for high-temp, high-cycle applications
- Qualified up to 150 °C ambient; 200 °C on roadmap
- Available on SEARAY™ 1.27 mm pitch high-density arrays to 3,000 cycles (SEAF/SEAM)
- Product Roadmap includes SEARAY™ 0.80 mm, AcceleRate® HP, LP Array™ and Generate™ 0.80 mm
- Ideal for ATE applications

ROADMAP



High-cycle "super lube" for extreme mating cycles



Expand testing to MIL-DTL-55302 including salt spray and enhanced shock & vibration



URSA™ I/O configurations of power, signal, RF coax and high-speed contacts for high-reliability in harsh environments



Rugged blind mate solution with RF and optical connectivity for backplane applications

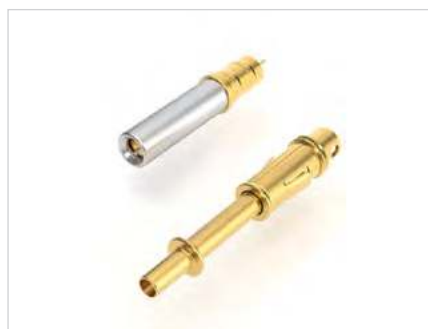

Size 16 and 20 high-frequency coax 38999 contacts for high-density, multi-position housings



Phase & insertion loss stable microwave/millimeter wave cable assemblies - Orange is the new cable!

ULTRA RUGGED TESTING

SEVERE ENVIRONMENT TESTING (SET)

Severe Environment Testing (SET) is a Samtec initiative to test products beyond typical industry standards and specifications for performance confidence in rugged/harsh environment industries. These products undergo additional testing, inspired by military standards, to ensure they are more than suitable for military, space, automotive, industrial and other extreme applications.

SET qualified products are Commercial Off-the-Shelf (COTS) and modified COTS for incredible design flexibility to get solutions to market faster. Visit samtec.com/SET or contact SET@samtec.com for additional information and current available test results.



MEETS OR EXCEEDS:

- VITA 47.1 Module Insertions
- VITA 47.3 Humidity
- VITA 47.1 Operating Shock Class OS2
- VITA 47.1 Vibration Class VS3
- Exceeds VITA 47.1 Temperature Cycling Class C4
- Exceeds VITA 47.1 Non-Operating Temperature Class C4
- VITA 47.1 Electrostatic Discharge Resistance
- Exceeds VITA 47.1 Altitude for DWV
- Aligns with MIL-DTL-55302

LOT SCREEN SAMPLE TESTING

Lot screen sample testing available to ensure product meets required specifications. Military/Aerospace Product (MAP) required; contact MAP@samtec.com

**TIGER
EYE**
SYSTEM

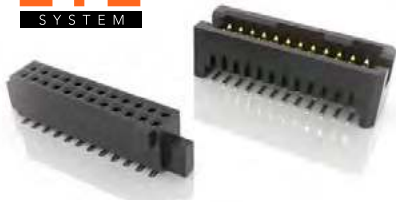

SEARAY



mPOWER



SET QUALIFIED PRODUCTS

SFM / TFM Tiger Eye™ 1.27 mm Pitch Micro Rugged System

SEAF / SEAM SEARAY™ High-Density Arrays

LSHM Razor Beam™ Hermaphroditic Strips

SSM / TSM .100" Pitch Square Post Header & Socket

FTSH / CLP .050" Pitch Header & Socket

ERF8 / ERM8 Edge Rate® Rugged High-Speed Strips

S2M / T2M Tiger Eye™ 2.00 mm Pitch Micro Rugged System

UMPS / UMPT mPOWER® Ultra Micro Power Connectors

SEAF8 / SEAM8 SEARAY™ 0.80 mm Ultra-High Density Arrays

NASA

Samtec's SET products are approved for NASA Class D missions that require high-reliability, quick-turn and cost-effective solutions for LEO satellites, SmallSats, CubeSats and other space exploration applications.

Samtec also utilizes NASA outgassing data to determine if certain products meet NASA's ASTM E595-77/84/90 test requirements. Visit outgassing.nasa.gov for data.

EXTENDED LIFE PRODUCT™

E.L.P.™ products are tested to rigorous standards, which evaluate contact resistance in simulated storage and field conditions.

- 10 year Mixed Flowing Gas (MFG)
- High Mating Cycles (250 to 2,500)
- Certain plating and/or contact options will apply

For complete details about Samtec's E.L.P.™ program, a list of qualifying products and test results, please visit samtec.com/ELP or email the Customer Engineering Support Group at ASG@samtec.com



DESIGN QUALIFICATION TESTING (DQT)

All Samtec series undergo Design Qualification Testing (DQT), which includes:

- Gas Tight
- Normal Force
- Thermal Aging
- Mating/Unmating/Durability
- IR/DWV
- Current Carrying Capacity (CCC)
- Mechanical Shock/Random Vibration/LLCR
- Mechanical Shock/Random Vibration/Event Detection



TESTING REFERENCE CHART

TEST	SET	E.L.P.™	DQT
Gas Tight	X*	X*	N/A
Normal Force	X*	X*	X
Thermal Aging	X*	X*	X
Mating / Unmating / Durability (240 Hrs)	X (100% RH, 250 Cycles)	X* (90-98% RH, 100 Cycles)	X (90-98% RH, 100 Cycles)
IR / DWV	X (At Altitude of 70,000 Feet)	X*	X
CCC	X*	X*	X
Mechanical Shock / Random Vibration / LLCR & Nanosecond Event Detection	X (40 G Peak, 11 ms, Half Sine & 12gRMS, 5 - 2,000 Hz, 1 Hr / Axis)	X* (100 G Peak, 6 ms, Half Sine & 7.56gRMS Avg, 2 Hr / Axis)	X (100 G Peak, 6 ms, Half Sine & 7.56gRMS Avg, 2 Hr / Axis)
Temperature Cycling (500 Cycles)	X	N/A	N/A
Non-Operating Class Temperature	X	N/A	N/A
Electrostatic Discharge (ESD)	X	N/A	N/A
10 Year MFG (Mixed Flowing Gas)	N/A	X	N/A
Mating Cycles (250 to 2,500)	N/A	X	N/A

* Completed as part of initial Design Qualification Testing (DQT). E.L.P.™ and SET testing are performed in addition to DQT.

POWER SERVICES

POWER INTEGRITY SERVICES

- Standard power test data, including current carrying capacity, working voltage, voltage drop and resistance, creepage and clearance, is available for select power systems
- Current Cycling Test Data, which demonstrates connector performance in realistic and common applications, is available for select series
- Power Integrity Guidelines are based on test data and proven design parameters, designed to help in connector selection and PCB design maximization
- Power Integrity Certified products undergo testing and additional requirements unique to Samtec. Products must pass Current Cycling Test EIA 365-55, have current carrying capacity, resistance vs. number of contacts data available and Power Integrity Guidelines developed
- Visit samtec.com/powerintegrity to learn more.

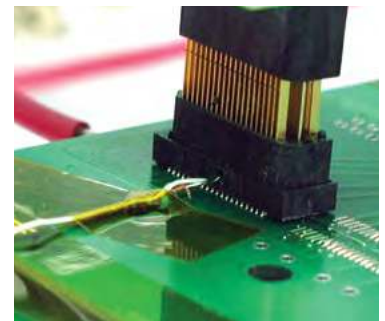
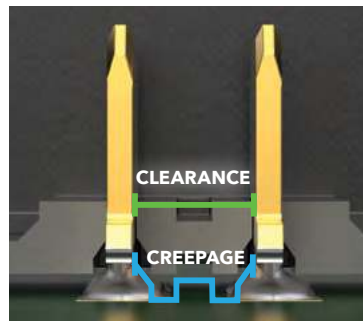
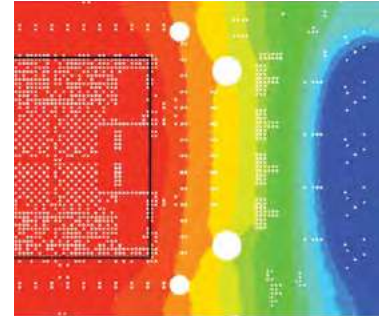

POWER ARCHITECTURE, SYSTEM DESIGN & ROUTING SERVICES

Samtec provides complete support and strategies for the optimization of system power architectures. Visit samtec.com/sig for more information.

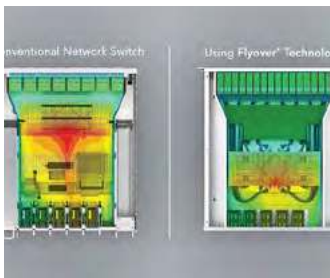

System Power Architectures & Design Solutions



Reference Routing Development for Application-Specific Solutions

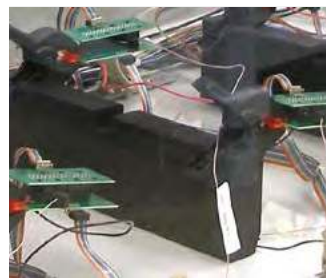

Safety and Reliability Design Assurance



Recommendations for Customer-Specific Requirements

INTERACTIVE POWER CHART

Samtec offers power simulation that can calculate temperature increase in the connector area, in real time. Find this tool on samtec.com when searching a product for your specific application. Contact RuggedPower@samtec.com for assistance.



HIGH POWER SYSTEMS

UP TO 60 AMPS • ULTRA MICRO POWER • POWER/SIGNAL COMBINATIONS



192-197

mPOWER® ULTRA MICRO POWER SYSTEMS

Socket & Terminal Board Connectors (UMPS, UMPT)	192-194
Cable-to-Board Assemblies & Components (UMPC(T), IMPC, CC489)	195
Cable-to-Cable Panel Mount Assemblies & Components (UMPE(T), UMPI(T), IMPE, IMPC, TC146, CC489) .	196-197

198-207

FLEX POWER SYSTEMS

EXTreme LPHPower™ Terminals and Sockets (LPHT, LPHS)	198-199
EXTreme Ten60Power™ Terminals and Sockets (ET60T, ET60S)	200-201
PowerStrip™/20 Headers & Sockets (UPS, UPT, UPPT)	202-203
PowerStrip™/30 Headers & Sockets (MPT, MPS, MPTC, MPSC)	204-205
PowerStrip™/40 Headers & Sockets (PET, PES, PETC, PES)	206-207

208-210

RUGGED POWER SYSTEMS

Mini Mate® Terminals & Sockets (IPT1, IPS1)	209
Power Mate® Terminals & Sockets (IPBT, IPBS)	210

ULTRA MICRO POWER SYSTEM

(2.00 mm) .0787" PITCH



MAX
18
A m p s

FEATURES & BENEFITS

- Board-to-board, cable-to-board and cable-to-cable
- Up to 18 A per blade (1 blade powered)
- Choice of 2 to 10 positions
- 5 mm to 20 mm stack heights; vertical and right-angle orientations
- Tin or 10 μ" Gold plated power blades; 30 μ" Gold plating available to meet specific regulations
- Optional weld tabs
- Mating cable assemblies with plastic top or metal side latching
- Severe Environment Testing qualified (UMPT/UMPS); aligns with MIL-DTL-55302. Visit samtec.com/set

KEY SPECIFICATIONS (UMPT/UMPS)

STACK HEIGHTS	INSULATOR MATERIAL	CONTACT MATERIAL	PLATING	OPERATING TEMP RANGE	VOLTAGE RATING	LEAD-FREE SOLDERABLE
5, 6, 7, 8, 9, 10, 11, 12, 13, 14, 15, 16, 18, 20 mm	Black LCP	Copper Alloy	Sn or Au over 50 μ" (1.27 μm) Ni	-55 °C to +105 °C with Tin -55 °C to +125 °C with Gold	460 VAC/ 650 VDC	Yes

CURRENT RATING (PER CONTACT)

PINS	UMPT/UMPS	
	-T	-L
1	17.8 A	17.5 A
2	15.5 A	16.3 A
3	13.5 A	13.9 A
4	12.9 A	13.2 A
10	9.8 A	8.9 A

Ratings are derated 20% with 30 °C rise to maximum allowable temperature.

CREEPAGE & CLEARANCE

UMPT/UMPS	
CREEPAGE	2.20 mm
CLEARANCE	1.65 mm

Selectively loading contacts achieves customer specific creepage and clearance requirements.

ULTRA MICRO POWER SOCKET

UMPS	NO. OF POSITIONS	LEAD STYLE	PLATING OPTION	V	S	OPTION	"X"R
	-02, -03, -04, -05, -06, -07, -08, -09, -10	-03.5 = (03.5 mm) .138" -05.5 = (05.5 mm) .217" -07.5 = (07.5 mm) .295"	-L = 10 μ" (0.25 μm) Gold on contact, Matte Tin on tail -S = 30 μ" (0.76 μm) Gold on contact, Matte Tin on tail -T = Matte Tin			-W = Weld Tab Through-hole (Leave blank for no weld tab)	-TR = Tape & Reel -FR = Full Reel Tape & Reel (must order max. quantity per reel; contact Samtec for quantity breaks)

UMPS
Board Mates:
UMPT
Standoffs:
GPSO

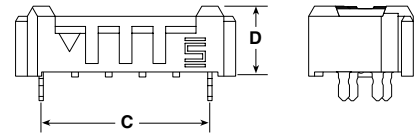
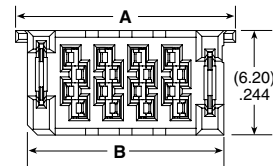

UMPS-04-03.5-X-V-S-W SHOWN

NO. OF POSITIONS	A	B	C
-02	(9.05) .356	(7.65) .301	(6.00) .236
-03	(11.05) .435	(9.65) .380	(8.00) .315
-04	(13.05) .514	(11.65) .459	(10.00) .394
-05	(15.05) .593	(13.65) .537	(12.00) .472
-06	(17.05) .671	(15.65) .616	(14.00) .551
-07	(19.05) .750	(17.65) .695	(16.00) .630
-08	(21.05) .829	(19.65) .774	(18.00) .709
-09	(23.05) .907	(21.65) .852	(20.00) .787
-10	(25.05) .986	(23.65) .931	(22.00) .866

LEAD STYLE	D
-03.5	(4.15) .163
-05.5	(6.15) .242
-07.5	(8.15) .321

UMPT LEAD STYLE	MATED HEIGHT		
	UMPS LEAD STYLE		
	-03.5	-05.5	-07.5
-01.5	(5.00) .197	(7.00) .276	(9.00) .354
-02.5	(6.00) .236	(8.00) .315	(10.00) .394
-06.5	(10.00) .394	(12.00) .472	(14.00) .551
-07.5	(11.00) .433	(13.00) .512	(15.00) .591
-12.5	(16.00) .630	(18.00) .709	(20.00) .787

UMPT/UMPS CURRENT RATING (PER CONTACT)

PINS	-T	-L
1	17.8 A	17.5 A
2	15.5 A	16.3 A
3	13.5 A	13.9 A
4	12.9 A	13.2 A
10	9.8 A	8.9 A

Ratings are derated 20% with 30 °C rise to maximum allowable temperature.

Notes:
Severe Environment
Testing qualified; aligns
with MIL-DTL-55302.
Visit samtec.com/set

Some lengths, styles and
options are non-standard,
non-returnable

View complete specifications at: samtec.com?UMPS

ULTRA MICRO POWER TERMINAL

UMPT	NO. OF POSITIONS	LEAD STYLE	PLATING OPTION	V	S	WELD TAB	LATCH OPTION	"X"R
UMPT Board Mates: -03, -04, -05, -06, -07, -08, -09, -10 UMPS Cable Mates: -09, -10 UMPC* (*UMPT requires -P or -M option for mating) Standoffs: GPSO	-02, -03, -04, -05, -06, -07, -08, -09, -10	-01.5 = (01.5 mm) .059" -02.5 = (02.5 mm) .098" -06.5 = (06.5 mm) .256" -07.5 = (07.5 mm) .295" -12.5 = (12.5 mm) .492" (-W option required)	-L = 10 μ" (0.25 μm) Gold on contact, Matte Tin on tail -S = 30 μ" (0.76 μm) Gold on contact, Matte Tin on tail -T = Matte Tin			(Leave blank for no weld tab) -W = Weld Tab Through-hole (Required for -12.5 lead style)	(Leave blank for no latch) (Only available on -02.5 lead style) (Weld tab required) -P = Plastic top latch -M = Metal side latches	-TR = Tape & Reel -FR = Full Reel Tape & Reel (must order max. quantity per reel; contact Samtec for quantity breaks)

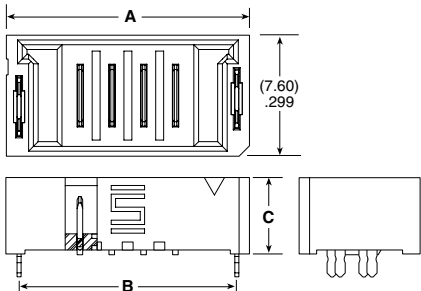
LEAD STYLE	C	NO. OF POSITIONS	
		A (-P & No latch)	B (-M latch)
-01.5	(4.80) .189	(11.30) .445	(9.70) .382
-02.5	(5.80) .228	(13.30) .524	(11.70) .460
-06.5	(9.55) .376	(15.30) .603	(13.70) .539
-07.5	(10.80) .425	(17.30) .681	(15.70) .618
-12.5	(15.80) .622	(19.30) .760	(17.70) .697
		(21.30) .839	(19.70) .776
		(23.30) .917	(21.70) .854
		(25.30) .996	(23.70) .933
		(27.30) 1.075	(25.70) 1.012
		(29.30) 1.154	(27.60) 1.087

Notes:
Severe Environment Testing qualified; aligns with MIL-DTL-55302. Visit samtec.com/set

Some lengths, styles and options are non-standard, non-returnable.

View complete specifications at: samtec.com?UMPT

UMPT	NO. OF POSITIONS	01	PLATING OPTION	RA	WELD TAB	LATCH OPTION	"X"R
UMPT-RA Board Mates: -02, -03, -04, -05, -06, -07, -08, -09, -10 UMPS Cable Mates: -09, -10 UMPC* (*UMPT requires -P or -M option for mating)	-02, -03, -04, -05, -06, -07, -08, -09, -10		-L = 10 μ" (0.25 μm) Gold on contact, Matte Tin on tail -S = 30 μ" (0.76 μm) Gold on contact, Matte Tin on tail -T = Matte Tin		-WT = Weld Tab Through-hole	(Leave blank for no latch) -P = Plastic top latch -M = Metal side latches	-TR = Tape & Reel -FR = Full Reel Tape & Reel (must order max. quantity per reel; contact Samtec for quantity breaks)

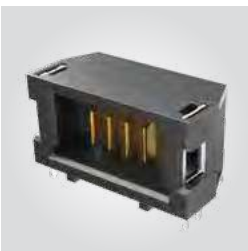
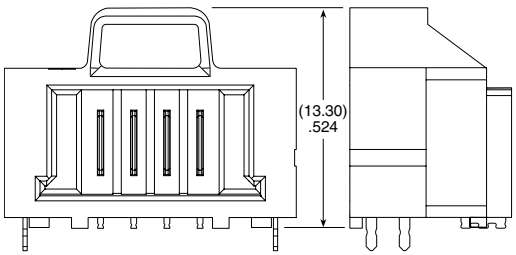
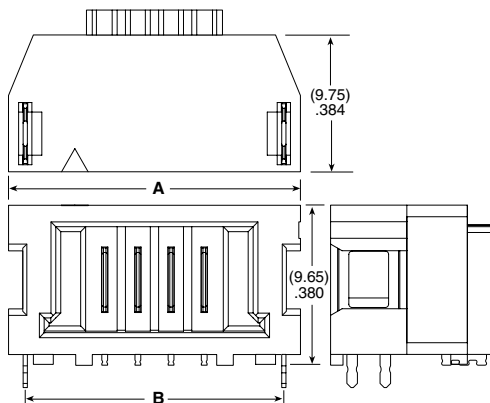
NO. OF POSITIONS	A		B	
	(-P & No latch)	(-M latch)	(-P & No latch)	(-M latch)
-02	(13.60) .535	(11.10) .437	(11.55) .455	
-03	(15.60) .614	(13.10) .516	(13.55) .533	
-04	(17.60) .693	(15.10) .594	(15.55) .612	
-05	(19.60) .772	(17.10) .673	(17.55) .691	
-06	(21.60) .850	(19.10) .752	(19.55) .770	
-07	(23.60) .929	(21.10) .831	(21.55) .848	
-08	(25.60) 1.008	(23.10) .909	(23.55) .927	
-09	(27.60) 1.087	(25.10) .988	(25.55) 1.006	
-10	(29.60) 1.165	(27.10) 1.067	(27.55) 1.085	

Note:
Some lengths, styles and options are non-standard, non-returnable.

View complete specifications at: samtec.com?UMPT-RA

ULTRA MICRO POWER CABLE



SERIES	NO. OF POSITIONS	PLATING OPTION	WIRE GAUGE	LATCH OPTION	LENGTH	PINOUT
UMPC = Ultra Micro PVC Cable	-02, -03, -04, -05, -06, -07, -08, -09, -10	-L = 10 μ" (0.25 μm) Gold on contact, Tin on tail	-16 = 16 AWG	(Latching required)	-"XX.X" = Assembled Length in Inches	(Leave blank for Single ended)
UMPCT = Ultra Micro Blue *Teflon™ Fluoropolymer Cable		-S = 30 μ" (0.76 μm) Gold on contact, Tin on tail	-16C = Color Coded Cable (UMPC only)	-P = Plastic top latch	PVC Cable Single ended = (76.2 mm) 03.0" min. Double ended = (101.6 mm) 04.0" min. (2-4 positions) Double ended = (127.0 mm) 05.0" min. (5-10 positions)	-1 = Pin 01 to Pin 01
UMPC(T) Board Mates: UMPT (Plastic (-P) or metal (-M) latch required)		-T = Tin	-18 = 18 AWG	-M = Metal side latches	Teflon™ Fluoropolymer Double ended = (228.6 mm) 09.0" min. (2-4 positions) Double ended = (254.0 mm) 10.0" min. (5-10 positions)	-2 = Pin 01 to Pin N
			-18C = Color Coded Cable (UMPC only)			

UMPCT PRELIMINARY

UMPC/UMPT (TIN PLATING)	
PINS	CURRENT RATING (PER CONTACT)
1	18.1 A
2	15.8 A
3	13.5 A
4	12.2 A
10	9.2 A

CABLE COLOR CODING	
PIN	COLOR
1	BROWN
2	RED
3	ORANGE
4	YELLOW
5	GREEN
6	BLUE
7	VIOLET
8	GRAY
9	WHITE
10	BLACK

SPECIFICATIONS

Insulator Material: Black LCP
Contact Material: Copper Alloy
Plating: Sn or Au over 50 μ" (1.27 μm) Ni
Wire: 16 or 18 AWG
Voltage Rating: 435 VAC

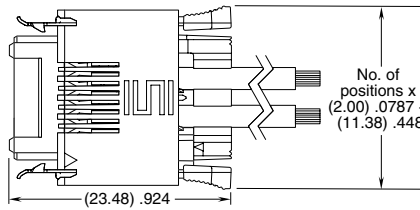

UMPC-04-X-XX-M-XX.X SHOWN

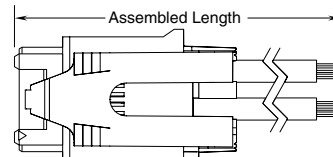

UMPC-03-X-XX-P-XX.X SHOWN

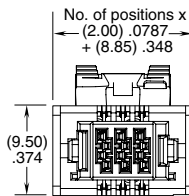

*Teflon™ is a trademark of The Chemours Company FC, LLC used under license by Samtec.

Note: For wiring option information refer to drawings on web.

View complete specifications at: samtec.com?UMPC & samtec.com?UMPT

UMPC CABLE HOLDER (Required for use with IMPC)

SERIES	NUMBER OF POSITIONS	LEAD STYLE
IMPC	-02, -03, -04, -05, -06, -07, -08, -09, -10	01 = 16 AWG
		02 = 18 AWG

IMPC

NO. OF POSITIONS

-02, -03, -04, -05, -06, -07, -08, -09, -10

LATCH OPTION

-P
= Plastic top latch

-M
= Metal side latches

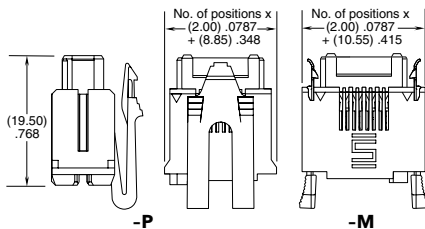

CC489

01

PLATING

-L
= 10 μ" (0.25 μm) Gold on contact, Tin on tail

-S
= 30 μ" (0.76 μm) Gold on contact, Tin on tail

PACKAGING

-R
= Full Reel (5,000 Contacts)

-M
= Mini Reel (1,000 Contacts)

-B
= Bubble Bag (35 Contacts)

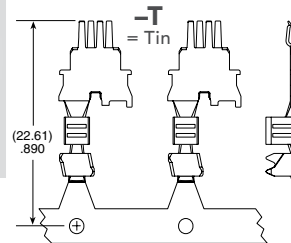
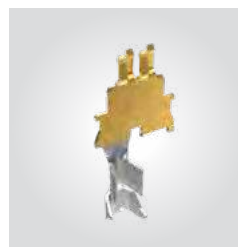

TOOLING

Hand Tool: CAT-HT-489-1618-13

Mini Applicator: CAT-MC-489-1618-XX-01

Note: Some lengths, styles and options are non-standard, non-returnable.

View complete specifications at: samtec.com?IMPC & samtec.com?CC489

ULTRA MICRO CABLE-TO-CABLE



SERIES	NO. OF POSITIONS	PLATING OPTION	WIRE GAUGE	LENGTH	END 2 OPTION	PINOUT
UMPE = Ultra Micro PVC Cable UMPET = Ultra Micro Blue *Teflon™ Fluoropolymer Cable	-02, -03, -04, -05, -06, -07, -08, -09, -10	-L = 10 μ" (0.25 μm) Gold on contact, Tin on tail -S = 30 μ" (0.76 μm) Gold on contact, Tin on tail -T = Tin	-16 = 16 AWG -16C = 16 AWG Color Coded Cable (not available with UMPET) -18 = 18 AWG -18C = 18 AWG Color Coded Cable (not available with UMPET)	-"XX.X" = Assembled Length in Inches Single ended = (76.2 mm) 03.0" min. Double ended = (101.6 mm) 04.0" min. (2-4 positions) Double ended = (127.0 mm) 05.0" min. (5-10 positions)	(Leave blank for Single ended) -T = Terminal -S = Socket	(Leave blank for Single ended) -M1 = Metal Latch Pin 01 to Pin 01 -M2 = Metal Latch Pin 01 to Pin N -P1 = Plastic Latch Pin 01 to Pin 01 -P2 = Plastic Latch Pin 01 to Pin N (PX only available with -S end option)

UMPE(T)
Cable Mates:
UMPI(T)
End 2 Mates:
UMPI(T), UMPT

UMPET
PRELIMINARY

SPECIFICATIONS

Insulator Material: Black LCP
Contact Material: Copper Alloy
Plating: Sn or Au over 50 μ" (1.27 μm) Ni
Wire: 16 or 18 AWG
Voltage Rating: 300 Volt = 16 & 18 AWG PVC 300 Volt = 16 AWG Teflon™ Fluoropolymer 600 Volt = 18 AWG Teflon™ Fluoropolymer

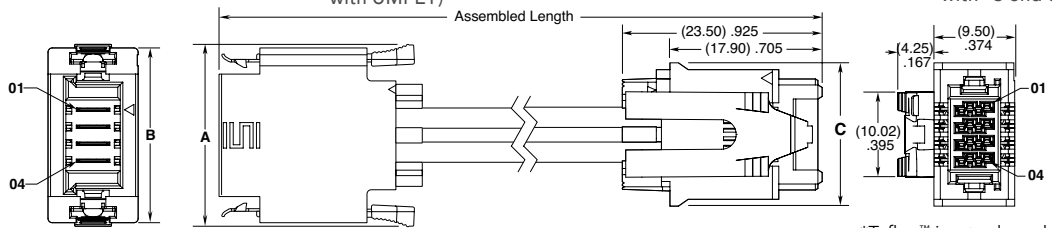

NO. OF POSITIONS	A	B	C
-02	(17.38) .684	(16.55) .652	(12.85) .506
-03	(19.38) .763	(18.55) .730	(14.85) .585
-04	(21.38) .842	(20.55) .809	(16.85) .663
-05	(23.38) .920	(22.55) .888	(18.85) .742
-06	(25.38) .999	(24.55) .967	(20.85) .821
-07	(27.38) 1.078	(26.55) 1.045	(22.85) .900
-08	(29.38) 1.157	(28.55) 1.124	(24.85) .978
-09	(31.38) 1.235	(30.55) 1.203	(26.85) 1.057
-10	(33.38) 1.314	(32.55) 1.281	(28.85) 1.136

CABLE COLOR CODING	
PIN	COLOR
1	BROWN
2	RED
3	ORANGE
4	YELLOW
5	GREEN
6	BLUE
7	VIOLET
8	GRAY
9	WHITE
10	BLACK

*Teflon™ is a trademark of The Chemours Company FC, LLC used under license by Samtec.

Notes: Teflon™ Fluoropolymer cable is intended for crimp only. Contact Samtec for solderable cable applications.

For wiring option information refer to drawings on web.

Some lengths, styles and options are non-standard, non-returnable

UMPE CABLE HOLDER (Required for use with UMPE)		
SERIES	NUMBER OF POSITIONS	LEAD STYLE
IMPEC	-02, -03, -04, -05, -06, -07, -08, -09, -10	01 = 16 AWG 02 = 18 AWG

View complete specifications at: samtec.com?UMPE & samtec.com?UMPET

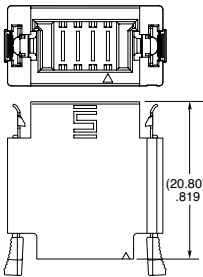
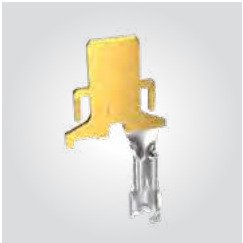
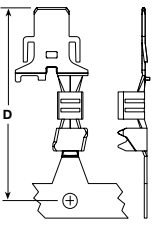
IMPE	NO. OF POSITIONS	LATCH OPTION	TC146	01	PLATING	HOT SWAP	PACKAGING						
	-02, -03, -04, -05, -06, -07, -08, -09, -10	-M = Metal Side Latches			-L = 10 μ" (0.25 μm) Gold on contact, Tin on tail -S = 30 μ" (0.76 μm) Gold on contact, Tin on tail -T = Tin	-1 = 6.60 -2 = 7.10	-R = Full Reel (5,000 Contacts) -M = Mini Reel (1,000 Contacts) -B = Bubble Bag (35 Contacts)						
							<table border="1"> <thead> <tr> <th>HOT SWAP</th> <th>D</th> </tr> </thead> <tbody> <tr><td>-1</td><td>(21.31) .839</td></tr> <tr><td>-2</td><td>(21.81) .859</td></tr> </tbody> </table>	HOT SWAP	D	-1	(21.31) .839	-2	(21.81) .859
HOT SWAP	D												
-1	(21.31) .839												
-2	(21.81) .859												

Note: Some lengths, styles and options are non-standard, non-returnable.

TOOLING

Hand Tool: CAT-HT-489-1618-13	Mini Applicator: CAT-MC-489-1618-XX-01
-------------------------------	--

View complete specifications at: samtec.com?IMPE & samtec.com?TC146

ULTRA MICRO CABLE-TO-CABLE

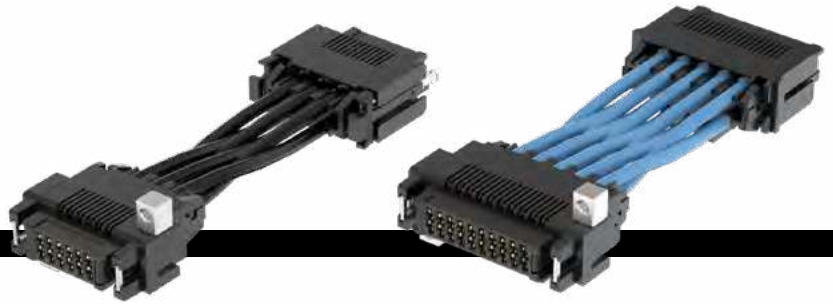

SERIES	NO. OF POSITIONS	PLATING OPTION	WIRE GAUGE	LENGTH	PINOUT
UMPI = Ultra Micro PVC Cable UMPI(T) = Ultra Micro Blue *Teflon™ Fluoropolymer Cable	-02, -03, -04, -05, -06, -07, -08, -09, -10	-L = 10 μ" (0.25 μm) Gold on contact, Tin on tail -S = 30 μ" (0.76 μm) Gold on contact, Tin on tail -T = Tin	-16 = 16 AWG -16C = 16 AWG Color Coded Cable (not available with UMPI(T)) -18 = 18 AWG -18C = 18 AWG Color Coded Cable (not available with UMPI(T))	-"XX.X" = Assembled Length in Inches Single ended = (76.2 mm) 03.0" min. Double ended = (101.6 mm) 04.0" min. (2-4 positions) Double ended = (127.0 mm) 05.0" min. (5-10 positions)	(Leave blank for Single ended) -M1 = Metal Latch Pin 01 to Pin 01 -M2 = Metal Latch Pin 01 to Pin N -P1 = Plastic Latch Pin 01 to Pin 01 -P2 = Plastic Latch Pin 01 to Pin N

UMPI(T)
Cable Mates:
UMPE(T)
End 2 Mates:
UMPE(T), UMPT

UMPT
PRELIMINARY

SPECIFICATIONS

Insulator Material:
Black LCP
Contact Material:
Copper Alloy
Plating:
Sn or Au over 50 μ" (1.27 μm) Ni
Wire:
16 or 18 AWG
Voltage Rating:
00 Volt = 16 & 18 AWG PVC
300 Volt = 16 AWG Teflon™ Fluoropolymer
600 Volt = 18 AWG Teflon™ Fluoropolymer

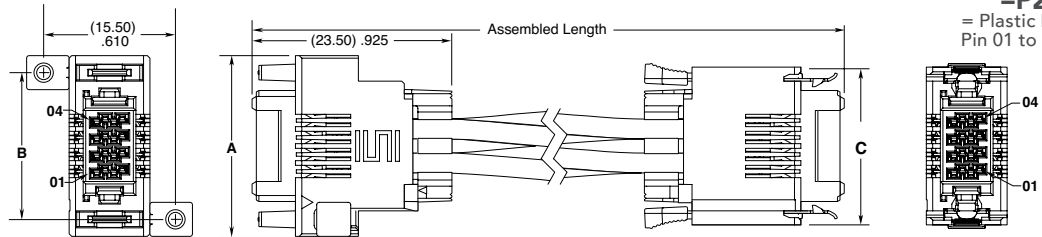

CABLE COLOR CODING	PIN	COLOR
1	BROWN	
2	RED	
3	ORANGE	
4	YELLOW	
5	GREEN	
6	BLUE	
7	VIOLET	
8	GRAY	
9	WHITE	
10	BLACK	

NO. OF POSITIONS	A	B	C
-02	(17.25) .679	(13.25) .522	(14.55) .573
-03	(19.25) .758	(15.25) .600	(16.55) .652
-04	(21.25) .837	(17.25) .679	(18.55) .730
-05	(23.25) .915	(19.25) .758	(20.55) .809
-06	(25.25) .994	(21.25) .837	(22.55) .888
-07	(27.25) 1.073	(23.25) .915	(24.55) .967
-08	(29.25) 1.152	(25.25) .994	(26.55) 1.045
-09	(31.25) 1.230	(27.25) 1.073	(28.55) 1.124
-10	(33.25) 1.309	(29.25) 1.152	(30.55) 1.203

*Teflon™ is a trademark of The Chemours Company FC, LLC used under license by Samtec.

Notes:
Teflon™ Fluoropolymer cable is intended for crimp only. Contact Samtec for solderable cable applications.

For wiring option information refer to drawings on web.

Some lengths, styles and options are non-standard, non-returnable

UMPI CABLE HOLDER (Required for use with IMPC)

SERIES	NUMBER OF POSITIONS	LEAD STYLE
IMPC	-02, -03, -04, -05, -06, -07, -08, -09, -10	01 = 16 AWG 02 = 18 AWG

View complete specifications at: samtec.com?UMPI & samtec.com?UMPT

IMPC	NO. OF POSITIONS	LATCH OPTION	CC489	01	PLATING	PACKAGING
	-02, -03, -04, -05, -06, -07, -08, -09, -10	-P1 = Panel Mount			-L = 10 μ" (0.25 μm) Gold on contact, Tin on tail -S = 30 μ" (0.76 μm) Gold on contact, Tin on tail -T = Tin	-R = Full Reel (5,000 Contacts) -M = Mini Reel (1,000 Contacts) -B = Bubble Bag (35 Contacts)

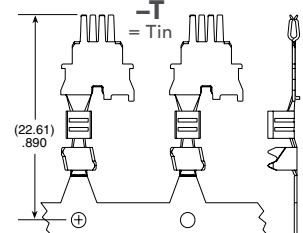
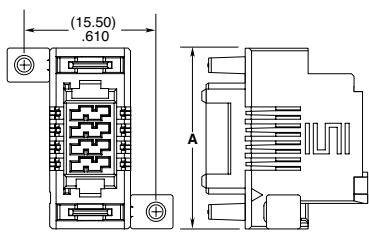
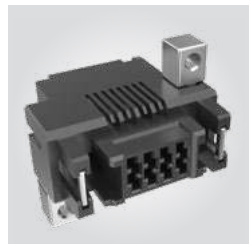

TOOLING

Hand Tool: CAT-HT-489-1618-13

Mini Applicator: CAT-MC-489-1618-XX-01

View complete specifications at: samtec.com?IMPC & samtec.com?CC489

LOW PROFILE, EXTREME HIGH-POWER/SIGNAL COMBO

FEATURES & BENEFITS

- 30 A per power blade and 1 A per signal pin
- Low 7.5 mm profile design (right-angle) for improved system airflow and space savings
- Double-stacked power blades per bank for increased density and power
- Ideal for coplanar and perpendicular applications
- Rugged guide posts are standard for blind mating assistance
- Socket available as vertical with press-fit tails and right-angle through-hole; mates with terminal or standard .062" (1.60 mm) PCB card

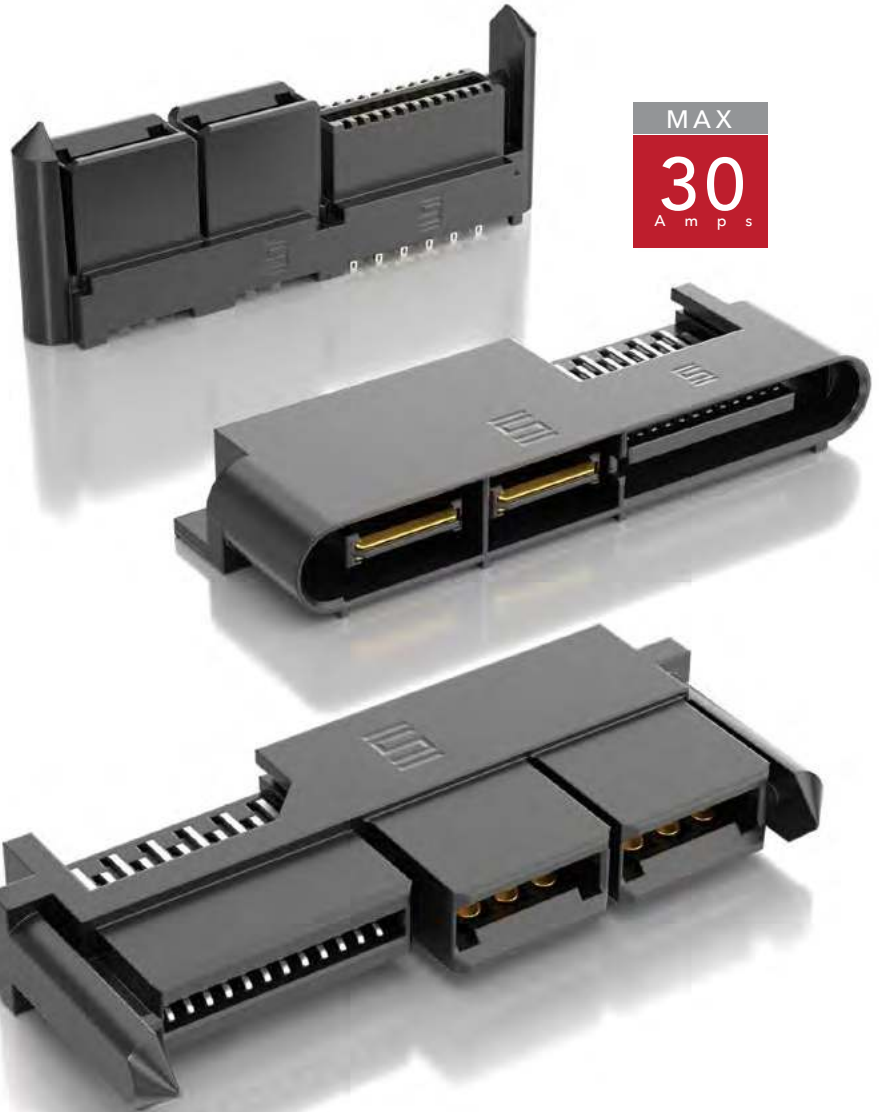

MAX
30
A m p s

Standard Creepage*	5.63 mm
Standard Clearance*	2.69 mm

*Selectively loading contacts achieves customer specific creepage and clearance requirements. Contact asp@samtec.com

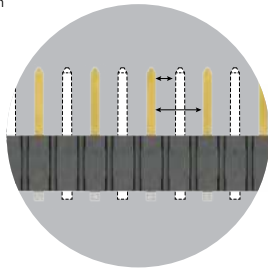

KEY SPECIFICATIONS (LPHT/LPHS)

PITCH	INSULATOR MATERIAL	TERMINAL MATERIAL	PLATING	OPERATING TEMP RANGE	VOLTAGE RATING	MATING CYCLES	LEAD-FREE SOLDERABLE
(12.00 mm) .472" (pwr) (1.27 mm) .050" (sig)	Black LCP	Signal: Brass Power: Copper Alloy	Au or Sn over 50 μ" (1.27 μm) Ni	40 °C to +105 °C	250 VAC / 500 VDC	250 (MFG Tested)	Yes (RT1 & RT2 option)

Notes:

Series is rated up to 60 A per power bank.
Some lengths, styles and options are non-standard, non-returnable.
The Molex EXTreme LPHPower™ line is a second source to the Samtec LPHT/LPHS Series.
*EXTreme LPHPower™ is a trademark of Molex Incorporated.

30 A SIGNAL/POWER COMBO SYSTEM

SERIES	POWER POSITIONS	SIGNAL POSITIONS	PLATING OPTION	TAIL	GP
--------	-----------------	------------------	----------------	------	----

LPHT
Terminal
LPHS
Socket

Total, 2 per power bank
**-02, -04,
-06, -08, -10**

Total
**-12,
-16, -20,
-24, -32**

-L
= 10 μ" (0.25 μm)
Gold on contact,
Matte Tin on tail

-VP1
= Vertical Press-fit
(LPHS only)
-RT1
= Right-angle Through-hole
(Use with (1.60 mm) .062" thick board)

-RT2
= Right-angle Through-hole
(Use with (2.36 mm) .093" thick board)

LPHT
Board Mates:
LPHS



SIGNAL POSITIONS	POWER POSITIONS				
	A (-02)	A (-04)	A (-06)	A (-08)	A (-10)
-16	(33.97) 1.337	(45.97) 1.810	(57.97) 2.282	(69.97) 2.755	(81.97) 3.227
-20	(36.51) 1.437	(48.51) 1.910	(60.51) 2.382	(72.51) 2.855	(84.51) 3.327
-24	(39.05) 1.537	(51.05) 2.010	(63.05) 2.482	(75.05) 2.955	(87.05) 3.427
-32	(44.13) 1.737	(56.13) 2.210	(68.13) 2.682	(80.13) 3.155	(92.13) 3.627

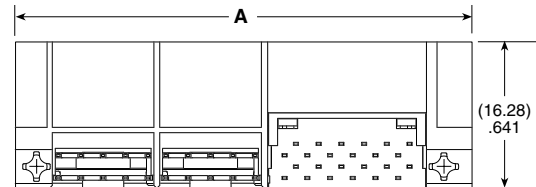
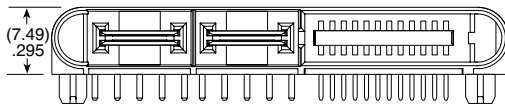

View complete specifications at: samtec.com?LPHT

LPHS
Board Mates:
LPHT



SIGNAL POSITIONS	POWER POSITIONS									
	A (-02)	B (-02)	A (-04)	B (-04)	A (-06)	B (-06)	A (-08)	B (-08)	A (-10)	B (-10)
-16	(31.64) 1.918	(25.88) 1.019	(43.64) 1.718	(37.88) 1.491	(55.64) 2.191	(49.88) 1.964	(67.64) 2.633	(61.88) 2.436	(79.64) 3.135	(73.88) 2.909
-20	(34.18) 1.346	(28.42) 1.119	(46.18) 1.818	(40.42) 1.591	(58.18) 2.291	(52.42) 2.064	(70.18) 2.763	(64.42) 2.536	(82.18) 3.235	(76.42) 3.009
-24	(36.72) 1.446	(30.96) 1.219	(48.72) 1.918	(42.96) 1.691	(60.72) 2.391	(54.96) 2.164	(72.72) 2.863	(66.96) 2.636	(84.72) 3.335	(78.96) 3.109
-32	(41.80) 1.646	(36.04) 1.419	(53.80) 2.118	(48.04) 1.891	(65.80) 2.591	(60.04) 2.364	(78.04) 3.063	(72.04) 2.836	(89.80) 3.535	(84.04) 3.309

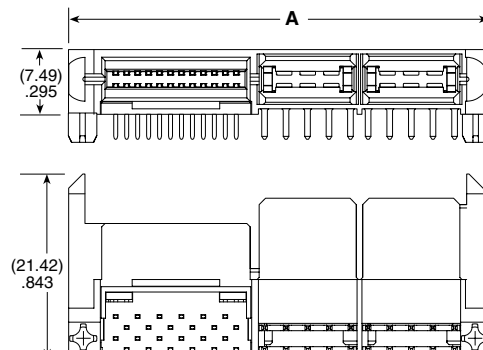
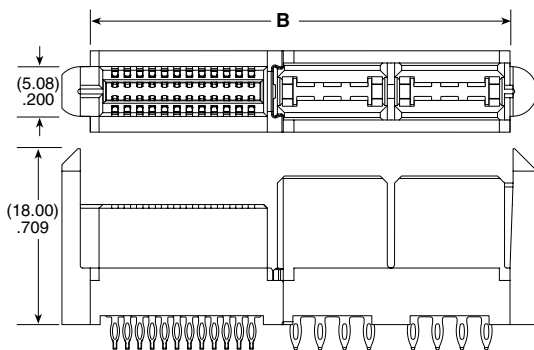

-VP

-RT

View complete specifications at: samtec.com?LPHS

POWER™ EXTreme STRIP Ten60

EXTREME HIGH-POWER 60 A SYSTEMS

FEATURES & BENEFITS

- Up to 60 A per power blade (2 blades powered)
- Low 10 mm profile (right-angle) for enhanced system airflow
- Power only, or power/signal combinations
- 3 or 5 signal rows in the same form factor
- AC power, DC power, power/signal combinations and split power options available
- Coplanar and perpendicular applications
- Modules can be configured to accommodate most any design
- Rugged guide posts are standard; top design for board space savings
- Press-fit (ET60S only) and hot swap (ET60T only) options available

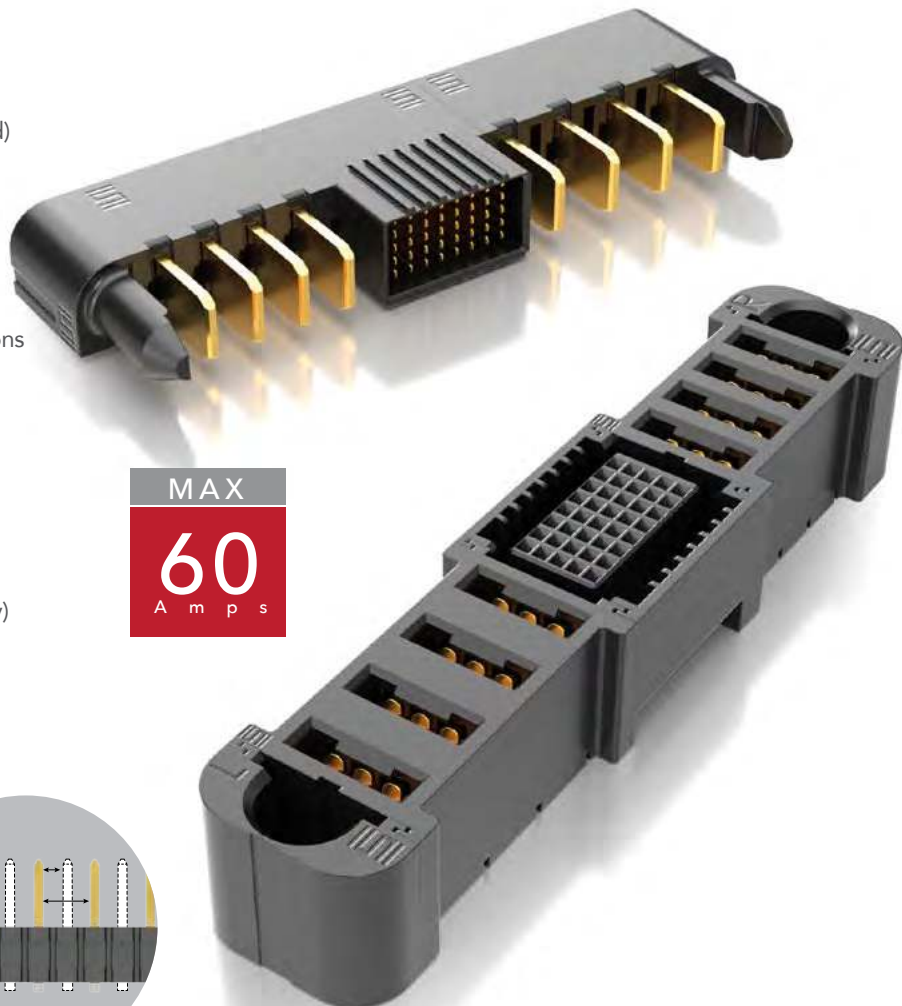

Standard Creepage*	3.02 mm
Standard Clearance*	1.87 mm

*Selectively loading contacts achieves customer specific creepage and clearance requirements. Contact asp@samtec.com

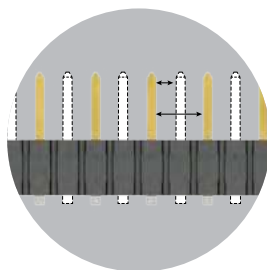

KEY SPECIFICATIONS (ET60T/ET60S)

	PITCH	INSULATOR MATERIAL	TERMINAL MATERIAL	PLATING	OPERATING TEMP RANGE	VOLTAGE RATING	MATING CYCLES	LEAD-FREE SOLDERABLE
Power	(5.50 mm) .217" (7.50 mm) .295"	Black LCP	Signal: Phosphor Bronze Power: Copper Alloy	Au or Sn over 50 μ" (1.27 μm) Ni	-40 °C to +105 °C	280 VAC	500	Yes
Signal	(2.00 mm) .097" (5 row) (2.54 mm) .100" (3 row)							

Notes:

Some lengths, styles and options are non-standard, non-returnable.
*EXTreme Ten60Power™ is a trademark of Molex Incorporated and is dual sourced by Molex®

60 A SIGNAL/POWER COMBO SYSTEM

SERIES	POWER OPTION (R)	ROWS	SIGNAL POS. PER ROW	POWER OPTION (L)	PLATING	TAIL	GUIDE POST	OPTION
ET60T Terminal	-AXX = AC Power Positions (02 - 06)	-0 = No Signal	-00 = No Signal	-AXX = AC Power Positions (02 - 06)	-L = 10 μ" (0.25 μm) Gold on contact, Matte Tin on tail (Not available for 5 rows)	-R1 = Right-angle Through-hole (Use with (1.60 mm) .062" thick card)	(Required callout)	(Leave blank for no hot swap)
ET60S Socket	-DXX = DC Power Positions (02 - 10)	-3	-08 = 3 Row only	-DXX = DC Power Positions (02 - 10)	-S = 30 μ" (0.76 μm) Gold on contact, Matte tin on tail	-VP = Vertical Press-fit (Not available with ET60T)	-S = Side Guide Post	-H = Hot Swap (ET60T only)
	-SXX* = Split Power	-5	-01, -02, -03, -04, -05, -06, -07, -08 = 5 Row only	-SXX* = Split Power		-V1 = Vertical Through-hole (Use with (1.60 mm) .062" thick card) (-0 and -3 Row only) (Not available with ET60T)	-T* = Top Guide Post	
	-000 = No Power			-000 = No Power				

ET60T
Board Mates:
ET60S

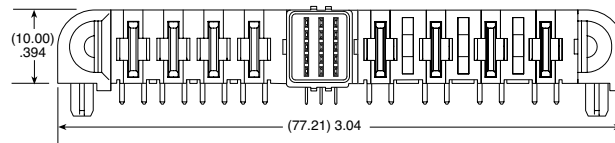
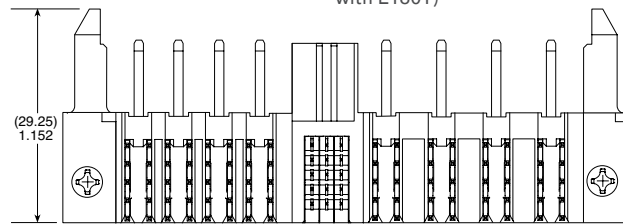
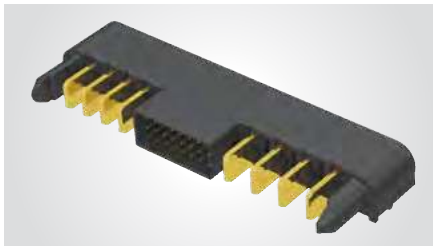

ET60T-D04-5-03-A04-X-R1-S SHOWN

View complete specifications at: samtec.com?ET60T

ET60S
Board Mates:
ET60T

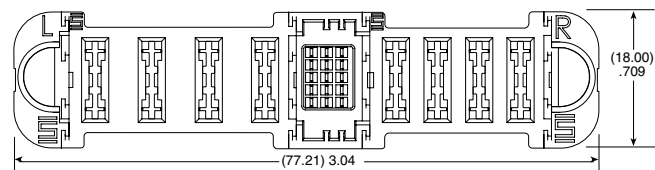
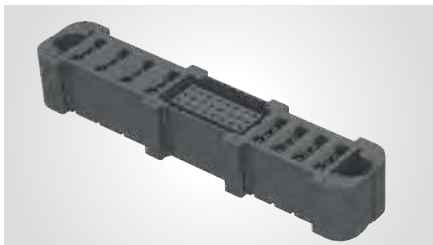

VERTICAL

ET60S-D04-5-03-A04-X-VP-S SHOWN

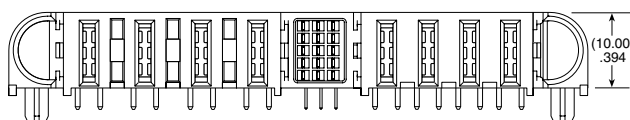

RIGHT-ANGLE

ET60S-D04-5-03-A04-X-R1-S SHOWN

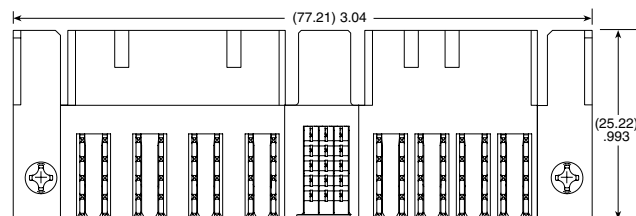

View complete specifications at: samtec.com?ET60S

HIGH POWER SYSTEMS

20-60 A
per blade

FEATURES & BENEFITS

- Current Rating: 23 A - 58.7 A per power blade
- 3.81 mm, 5.00 mm and 6.35 mm pitch
- Dual blade contact system
- Power only or power/signal combinations available
- Right-angle and vertical orientations
- Rugged screw down and locking clip options
- Discrete wire cable assemblies with 10-16 AWG wire (see pages 246-248)
- "Hinged" for unique mating in any orientation from 0° to 90° and space confined applications

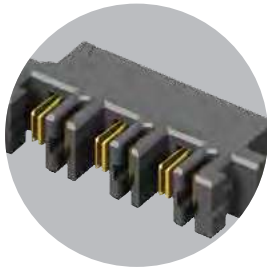

Hermaphroditic options
samtec.com?MPPT and
samtec.com?UPPT

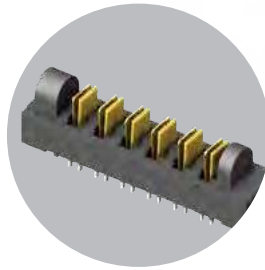

Hinging options available
samtec.com?FMPT and
samtec.com?FMPS

CREEPAGE & CLEARANCE

SERIES	CREEPAGE	CLEARANCE
UPT/UPS/UPPT	5.50 mm	1.51 mm
MPT/MPS/MPTC/MPSC	2.95 mm	2.71 mm
PET/PES/PETC/PESC	3.66 mm	3.31 mm

Selectively loading contacts achieves customer specific creepage and clearance requirements.

KEY SPECIFICATIONS

SERIES	PITCH	INSULATOR MATERIAL	CONTACT MATERIAL	PLATING	OPERATING TEMP RANGE	CURRENT RATING	VOLTAGE RATING	LEAD-FREE SOLDERABLE
UPT/UPS	(3.81 mm) .150"	Black LCP	BeCu	Sn or Au over 50 μ" (1.27 μm) Ni	-55 °C to +105 °C (Sn) -55 °C to +125 °C (Au)	23 A (1 pin powered)	438 VAC	Yes
UPPT	(3.81 mm) .150"	Black LCP	Copper Alloy	Sn or Au over 50 μ" (1.27 μm) Ni	-55 °C to +105 °C (Sn) -55 °C to +125 °C (Au)	21.4 A (1 pin powered)	425 VAC	Yes
MPT/MPS	(5.00 mm) .1969"	Black LCP	Copper Alloy	Sn or Au over 50 μ" (1.27 μm) Ni	-55 °C to +105 °C (Sn) -55 °C to +125 °C (Au)	28.8 A (1 pin powered)	575 VAC	Yes
MPTC/MPSC	(5.00 mm) .197" (pwr) (2.00 mm) .079" (sig)	Black LCP	Signal: Phosphor Bronze Terminal: Copper Alloy	Sn or Au over 50 μ" (1.27 μm) Ni	-55 °C to +105 °C (Sn) -55 °C to +125 °C (Au)	28.8 A (pwr - 1 pin powered) 5 A (sig - 4 pins powered)	250 VAC	Yes
PET/PES	(6.35 mm) .250"	Black LCP	Copper Alloy	Sn or Au over 50 μ" (1.27 μm) Ni	-55 °C to +105 °C (Sn) -55 °C to +125 °C (Au)	58.7 A (1 pin powered)	450 VAC	Yes
PETC/PESC	(6.35 mm) .250" (pwr) (2.54 mm) .100" (sig)	Black LCP	Copper Alloy	Sn or Au over 50 μ" (1.27 μm) Ni	-55 °C to +105 °C (Sn) -55 °C to +125 °C (Au)	31.4 A (pwr - 1 pin powered) 5.7 A (sig - 4 pins powered)	650 VAC (pwr) 450 VAC (sig)	Yes

(3.81 mm) .150" PITCH • 20 A DUAL BLADE/LEAF POWER SYSTEMS

SERIES	POWER PINS	LEAD STYLE	TAIL LENGTH	PLATING OPTION	TAIL	OTHER OPTION	"X"R
UPT Terminal	-02	-01 = RA only	-01 = Use with (1.60 mm) .062" Thick PCB (-V & -RA only)	-L = 10 μ" (0.25 μm) Gold on contact, Matte Tin on tail	-V = Vertical (Not available with -T plating)	-LC = Locking Clip (Manual placement required) Not available with -PV option	Leave blank for tube packaging
	-04	-03.0 = (03.0 mm) .118" (UPT-V & UPT-PV only)	-03 = Use with (1.60 mm) .062" Thick PCB (-PV only)	-T = Matte Tin (-RA & -PV options only)	-RA = Right-angle		-TR = Tape & Reel
UPS Socket	-06	-04.0 = (04.0 mm) .157" (UPS-V & UPS-PV only)			-PV = Press-fit, Vertical		-FR = Full Reel Tape & Reel (must order max. quantity per reel; contact Samtec for quantity breaks)
	-08	-07.0 = (07.0 mm) .276" (UPS-V & UPS-PV only)					

UPT
Board Mates:
UPS

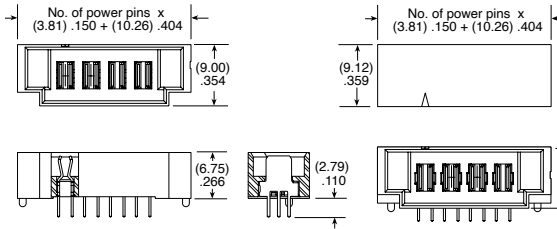

MATED HEIGHT*	
UPS LEAD STYLE	UPT LEAD STYLE
-03.0	-03.0
-04.0	(7.00) .276
-07.0	(10.00) .394

UPS
Board Mates:
UPT

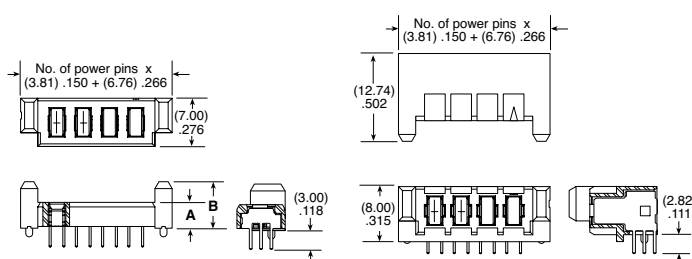

LEAD STYLE	A	B
-04.0	(3.75) .148	(6.75) .266
-07.0	(6.75) .266	(9.75) .384

*Processing conditions will affect mated height.

View complete specifications at: samtec.com?UPT & samtec.com?UPS

SERIES	NO. OF POSITIONS	01	TAIL LENGTH	PLATING OPTION	RA	SD	"X"R
UPPT Hermaphroditic	-02, -04, -06, -08		-01 = (1.60 mm) .062" Thick PCB	-L = 10 μ" (0.25 μm) Gold on contact, Matte Tin on tail			Leave blank for tube packaging
UPPT Board Mates: UPPT				-T = Matte Tin			-TR = Tape & Reel
							-FR = Full Reel Tape & Reel (must order max. quantity per reel; contact Samtec for quantity breaks)

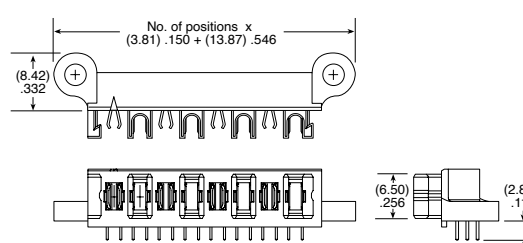
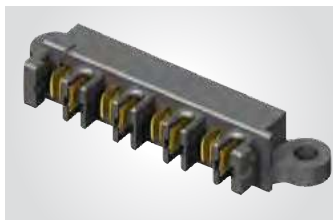

Note:
Some lengths, styles and options are non-standard, non-returnable

View complete specifications at: samtec.com?UPPT

(5.00 mm) .1969" PITCH • 30 A DUAL BLADE/LEAF SYSTEMS

SERIES	POWER PINS	LEAD STYLE	TAIL LENGTH	PLATING OPTION	TAIL
MPT Terminal	-02, -03, -04, -06, -08	-6.30 = (6.30 mm) 0.248" (MPT only)	-01 = Use with (1.60 mm) .062" Thick PCB -03 = Use with (2.36 mm) .093" Thick PCB	-L = 10 μ" (0.25 μm) Gold on contact, Matte Tin on tail -T = Matte Tin	(Required Callout) -V = Vertical
MPS Socket		-7.70 = (7.70 mm) 0.303" (MPS only)			

MPT

Board Mates:

MPS

Cable Mates:

MPSS

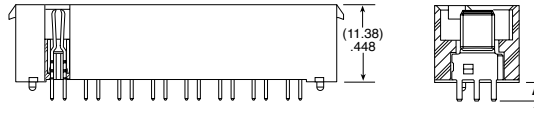
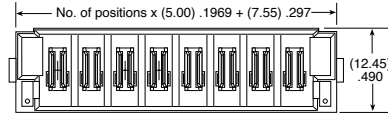

TAIL LENGTH	A
-01	(2.72) .107
-03	(3.51) .138

MATED HEIGHT

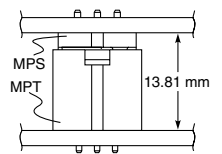

MPS

Board Mates:

MPT

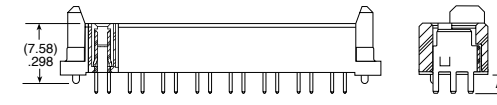
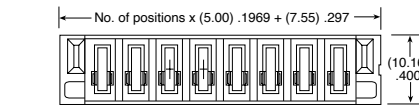

TAIL LENGTH	A
-01	(2.72) .107
-03	(3.52) .139

View complete specifications at: samtec.com?MPT & samtec.com?MPS

SERIES	POWER PINS	01	TAIL LENGTH	PLATING OPTION	RA	SD
MPT Terminal	-02, -04, -06, -08		-01 = Use with (1.60 mm) .062" Thick PCB -03 = Use with (2.36 mm) .093" Thick PCB	-L = 10 μ" (0.25 μm) Gold on contact, Matte Tin on tail -T = Matte Tin		
MPS Socket						

MPT-RA

Board Mates:

MPS

Cable Mates:

MPSS

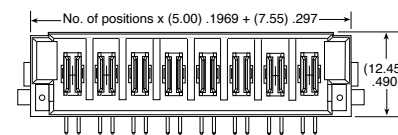
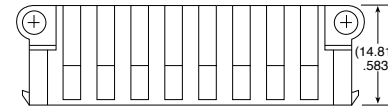

TAIL LENGTH	A
-01	(2.72) .107
-03	(3.51) .138

MPS-RA

Board Mates:

MPT

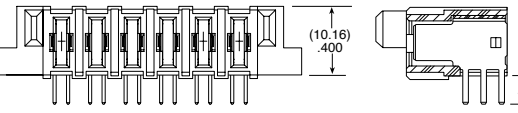
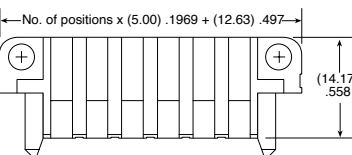

TAIL LENGTH	A
-01	(2.72) .107
-03	(3.52) .139

Note:
Some lengths, styles and options are non-standard, non-returnable

View complete specifications at: samtec.com?MPT & samtec.com?MPS

(5.00 mm) .197"(PWR) / (2.00 mm) .079"(SIG) • 30 A SIGNAL/POWER COMBO SYSTEMS

SERIES	POWER PINS	SIGNAL PINS	POWER PINS	LEAD STYLE	TAIL LENGTH	PLATING OPTION	V	OTHER OPTION
MPTC Terminal	Per end -01	-16 -24	Per end -01	-6.30 = (6.30 mm) 0.248" (MPTC only)	-01 = Use with (1.60 mm) .062" Thick PCB	-L = 10 μ" (0.25 μm) Gold on contact, Matte Tin on tail (Power & Signal)		-LC = Locking Clip (Manual placement required)
MPSC Socket	-02	-40 -80	-02	-7.70 = (7.70 mm) 0.303" (MPSC only)	-03 = Use with (2.36 mm) .093" Thick PCB	-T = Matte tin on contact and tail (power), Gold on contact, Matte tin on tail (Signal)		

MPTC
Board Mates:
MPSC
Cable Mates:
MPCC

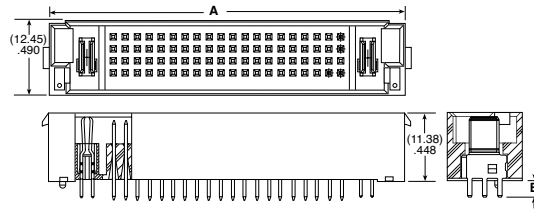

TAIL LENGTH	B
-01	(2.72) .107
-03	(3.51) .138

POWER PINS/ENDS	A			
	16 SIGNAL PINS	24 SIGNAL PINS	40 SIGNAL PINS	80 SIGNAL PINS
-01	(27.44) 1.081	(31.45) 1.238	(39.44) 1.553	(59.44) 2.340
-02	(37.44) 1.474	(41.45) 1.632	(49.44) 1.946	(69.44) 2.734

MPSC
Board Mates:
MPTC

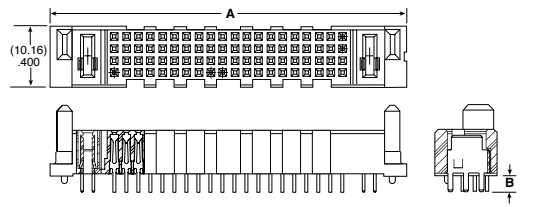
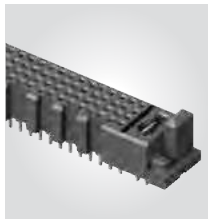

TAIL LENGTH	B
-01	(2.72) .107
-03	(3.52) .139

View complete specifications at: samtec.com?MPTC & samtec.com?MPSC

SERIES	POWER PINS	SIGNAL PINS	POWER PINS	01	TAIL LENGTH	PLATING OPTION	RA	OTHER OPTION
MPTC Terminal	Per end -01	-24 -80	Per end -01		-01 = Use with (1.60 mm) .062" Thick PCB	-L = 10 μ" (0.25 μm) Gold on contact, Matte Tin on tail (Power & Signal)		-SD or -LC is a required callout
MPSC Socket	-02		-02		-03 = Use with (2.36 mm) .093" Thick PCB	-T = Matte Tin on contact and tail (power), Gold on contact, Matte tin on tail (Signal)		-SD = Screw Down

MPTC-RA
Board Mates:
MPSC
Cable Mates:
MPCC

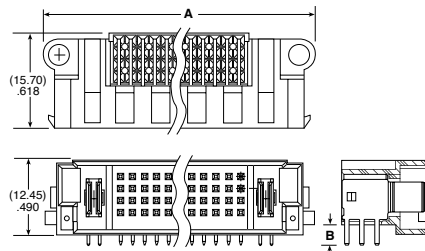

TAIL LENGTH	B
-01	(2.72) .107
-03	(3.51) .138

POWER PINS/ENDS	A	
	24 SIGNAL PINS	80 SIGNAL PINS
-01	(35.25) 1.388	(63.25) 2.490
-02	(45.25) 1.781	(73.25) 2.884

MPSC-RA
Board Mates:
MPTC

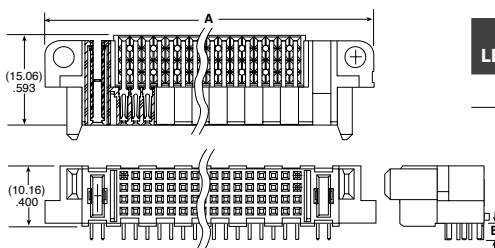

TAIL LENGTH	B
-01	(2.20) .087
-03	(3.00) .118

POWER PINS/ENDS	A	
	24 SIGNAL PINS	80 SIGNAL PINS
-01	(36.52) 1.438	(64.52) 2.540
-02	(46.52) 1.831	(74.52) 2.934

Note: Some lengths, styles and options are non-standard, non-returnable

View complete specifications at: samtec.com?MPTC & samtec.com?MPSC

(6.35 mm) .250" PITCH • 40 A HIGH-POWER SYSTEM

PET	NO. PINS PER ROW	LEAD STYLE	PLATING OPTION	TAIL OPTION	OTHER OPTION
	-02, -04, -06, -08	-01 = Use with (1.60 mm) .062" Thick PCB -02 = Use with (3.18 mm) .125" Thick PCB	-L = 10 μ" (0.25 μm) Gold on contact, Matte Tin on tail -T = Matte Tin	-VT = Vertical -RA = Right-angle (Screw Down option required)	-SD = Screw Down (Right-angle only)

PET

Board Mates:
PES
Cable Mates:
PESS

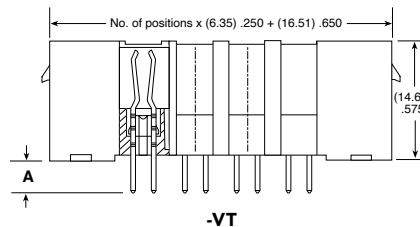

TAIL LENGTH	A
-01	(2.35) .093
-02	(3.95) .156

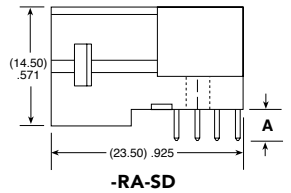

Note: Some lengths, styles and options are non-standard, non-returnable

View complete specifications at: samtec.com?PET

PES	NO. PINS PER ROW	LEAD STYLE	PLATING OPTION	TAIL OPTION	OTHER OPTION
	-02, -04, -06, -08	-01 = Use with (1.60 mm) .062" Thick PCB -02 = Use with (3.18 mm) .125" Thick PCB	-L = 10 μ" (0.25 μm) Gold on contact, Matte Tin on tail -T = Matte Tin	-VT = Vertical -RA = Right-angle (Screw Down option required)	-SD = Screw Down (Right-angle only)

PES

Board Mates:
PET

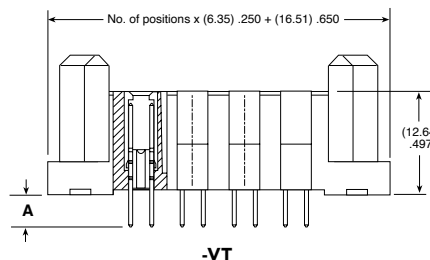

TAIL LENGTH	A	B
-01	(2.47) .097	(2.35) .093
-02	(4.07) .160	(3.95) .156

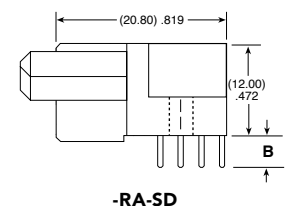

Note: Some lengths, styles and options are non-standard, non-returnable

View complete specifications at: samtec.com?PES

POWER™ STRIP40

(6.35 mm) .250" PITCH • 40 A HIGH POWER/SIGNAL SYSTEM

PETC	POWER PINS	SIGNAL PINS	POWER PINS	01	PLATING OPTION	TAIL	OTHER OPTION
	-01, -02, -04	-12, -40	-01, -02, -04		-L = 10 μ" (0.25 μm) Gold on contact, Matte Tin on tail -T = Matte Tin	-VT = Vertical -RA = Right-angle	-SD = Screw Down (Right-angle only) -LC = Locking Clip (Manual placement required)

PETC
Board Mates:
PESC

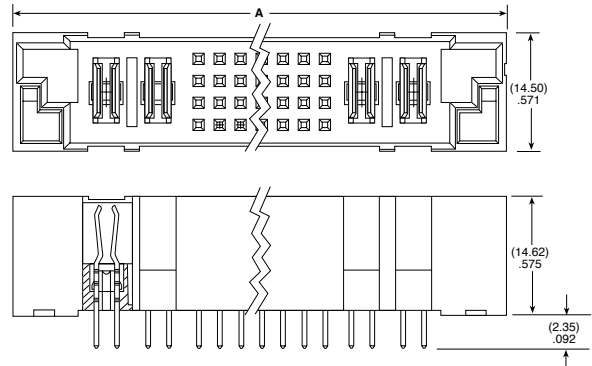

POWER PINS/ENDS	A	
	12 SIGNAL PINS	40 SIGNAL PINS
-01	(39.37) 1.550	(57.15) 2.250
-02	(52.07) 2.050	(69.85) 2.750
-04	(77.47) 3.050	(95.25) 3.750

Note:
Some lengths, styles and options are non-standard, non-returnable

View complete specifications at: samtec.com?PETC

PESC	POWER PINS	SIGNAL PINS	POWER PINS	01	PLATING OPTION	TAIL	OTHER OPTION
	-01, -02, -04	-12, -40	-01, -02, -04		-L = 10 μ" (0.25 μm) Gold on contact, Matte Tin on tail -T = Matte Tin	-VT = Vertical -RA = Right-angle	-SD = Screw Down (Right-angle only) -LC = Locking Clip (Manual placement required)

PESC
Board Mates:
PETC

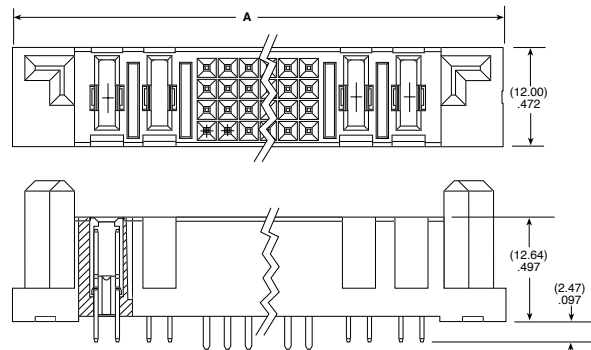
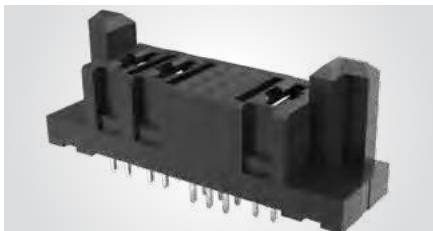

POWER PINS/ENDS	A	
	12 SIGNAL PINS	40 SIGNAL PINS
-01	(39.37) 1.550	(57.15) 2.250
-02	(52.07) 2.050	(69.85) 2.750
-04	(77.47) 3.050	(95.25) 3.750

Note:
Some lengths, styles and options are non-standard, non-returnable

View complete specifications at: samtec.com?PESC

ISOLATED POWER SYSTEMS

FEATURES & BENEFITS

- Individually shrouded contacts for electrical and mechanical protection
- .100" (2.54 mm) and .165" (4.19 mm) pitch
- Surface mount or through-hole
- Vertical and right-angle for parallel, perpendicular and coplanar applications
- Locking clip, key polarization and guide post options
- Discrete wire assemblies with 16-30 AWG PVC or Teflon™ fluoropolymer wire (see pages 243-245).
- Metal or plastic rugged latching system

*Teflon™ is a trademark of The Chemours Company FC, LLC used under license by Samtec

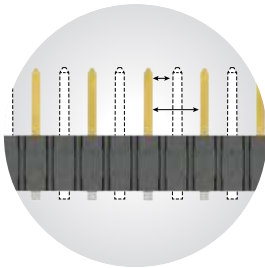

Selectively loading contacts achieves customer specific creepage and clearance requirements.

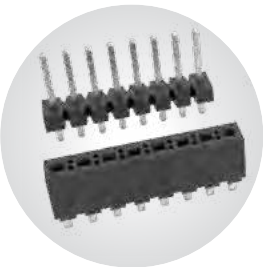

Flexible standard or high-power stacking systems with Power Eye three-finger BeCu contacts for reliable connection. For available series, visit samtec.com/flexiblestrips

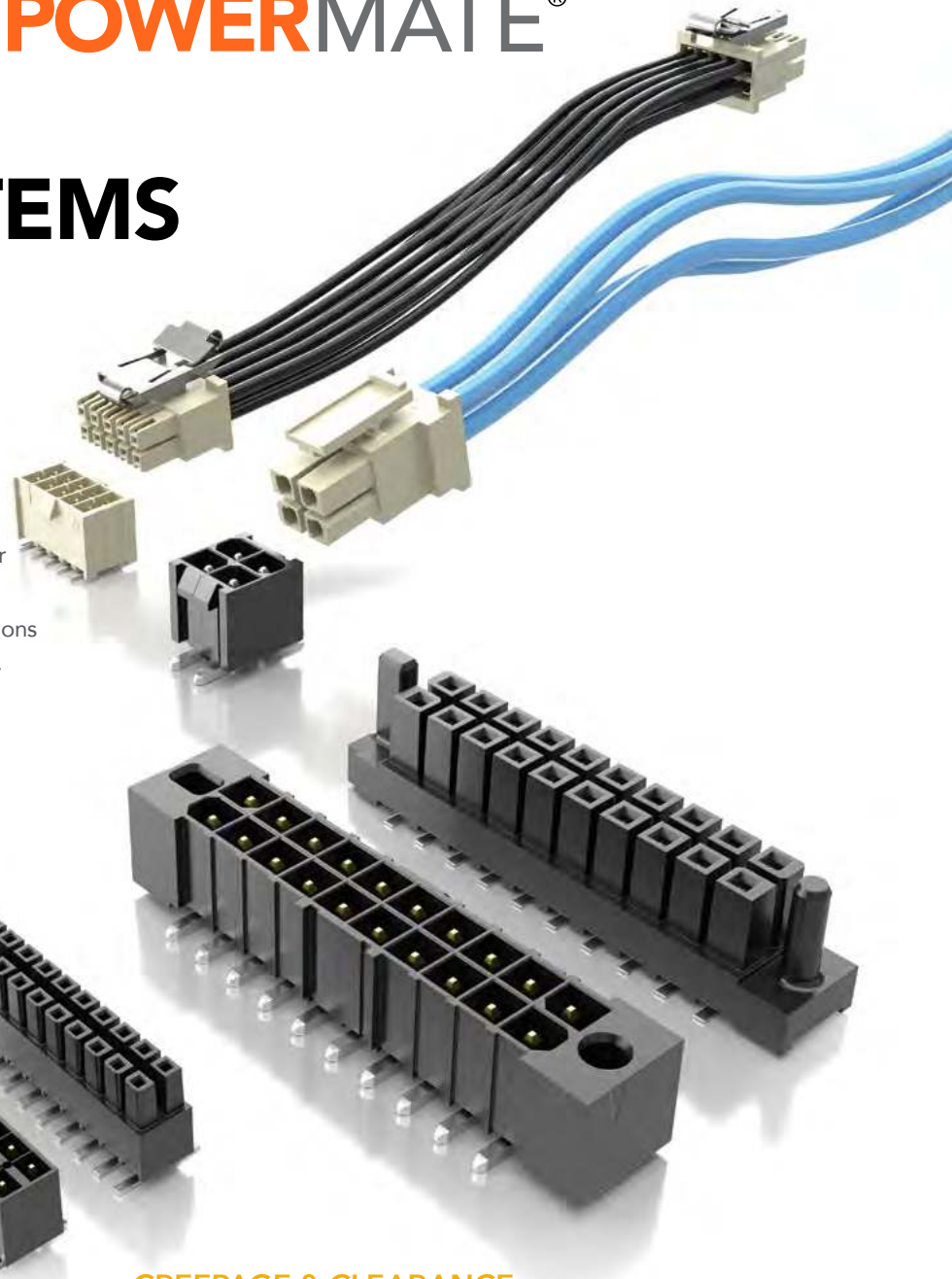

CREEPAGE & CLEARANCE

	CREEPAGE	CLEARANCE
IPT1/IPS1 MMSS(T)/MMSD(T)	2.54 mm	1.91 mm
IPBT/IPBS PMSS(T)/PMSD(T)	4.27 mm	3.05 mm

Selectively loading contacts achieves customer specific creepage and clearance requirements.

KEY SPECIFICATIONS

SERIES	PITCH	INSULATOR MATERIAL	CONTACT MATERIAL	PLATING	OPERATING TEMP RANGE	CURRENT RATING	VOLTAGE RATING	LEAD-FREE SOLDERABLE
IPT1/IPS1	.100" (2.54 mm)	Black LCP	Phosphor Bronze	Sn or Au over 50 μ" (1.27 μm) Nickel	-55 °C to +125 °C	5.9 A (1 pin power)	775 VAC	Yes
IPBT/IPBS	.165" (4.19 mm)	Black LCP	High Copper Alloy (IPBT) Phosphor Bronze (IPBS)	Sn over 50 μ" (1.27 μm) Nickel	-55 °C to +105 °C	10.3 A (2 pins power)	400 VAC	Yes

(2.54 mm) .100" PITCH • SHROUDED POWER CONNECTOR SET

IPT1	1	NO. PINS PER ROW	LEAD STYLE	PLATING OPTION	D	TAIL OPTION	OTHER OPTIONS
		05 10 15 20 25 (Standard Sizes)	Specify LEAD STYLE from chart	-L = 10 μ" (0.25 μm) Gold on contact, Matte Tin on tail		Requires -01 Lead Style (Leave blank for Through-hole) -RA = Right-angle -VS = Surface Mount	-A = Alignment Pin (-VS only) (N/A with -LC) -LC = Locking Clip (Manual placement required) (-VS only) (N/A with -A) -K = (6.00 mm) .236" DIA Polyimide film Pick & Place Pad (-VS only) -TR = Tape & Reel (-VS only) -FR = Full Reel Tape & Reel (must order max. quantity per reel; contact Samtec for quantity breaks) (-VS only)

IPT1
Board Mates:
IPS1

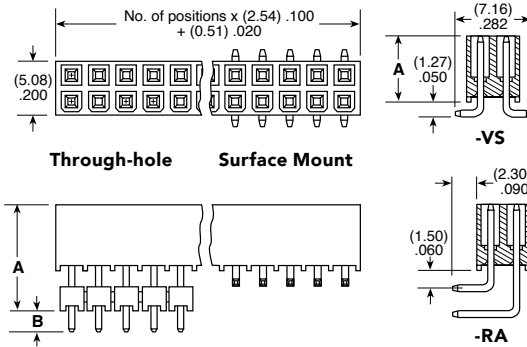

IPT1/IPS1	
PINS	CURRENT RATING (PER CONTACT)
1	5.9 A
2	4.8 A
3	4.1 A
4	3.6 A
50	2.3 A

LEAD STYLE	MATED HEIGHT	A	B
-01	(11.05) .435	(6.35) .250	(2.16) .085
-01-VS	(13.59) .535	(6.35) .250	N/A
-02	(14.00) .551	(9.30) .366	(2.64) .104
-03	(16.00) .630	(11.30) .445	(2.16) .085
-04	(17.00) .669	(12.30) .484	(2.69) .106
-05	(19.00) .748	(14.30) .563	(2.46) .097
-06	(20.00) .787	(15.30) .602	(2.35) .093
-07	(25.00) .984	(20.30) .799	(2.31) .091
-08	(30.00) 1.181	(25.30) .996	(2.39) .094
-09	(35.00) 1.378	(30.30) 1.193	(2.46) .097

IPS1	1	NO. PINS PER ROW	01	PLATING OPTION	D	TAIL OPTION	OTHER OPTIONS
		05 10 15 20 25 (Standard Sizes)		-L = 10 μ" (0.25 μm) Gold on contact, Matte Tin on tail		Leave blank for Through-hole -RA = Right-angle -VS = Surface Mount	-LC = Locking Clip (Manual placement required) (-VS only) -K = (5.50 mm) .217" DIA Polyimide film Pick & Place Pad (-VS only) -TR = Tape & Reel (-VS only) -FR = Full Reel Tape & Reel (must order max. quantity per reel; contact Samtec for quantity breaks) (-VS only)

IPS1
Board Mates:
IPT1

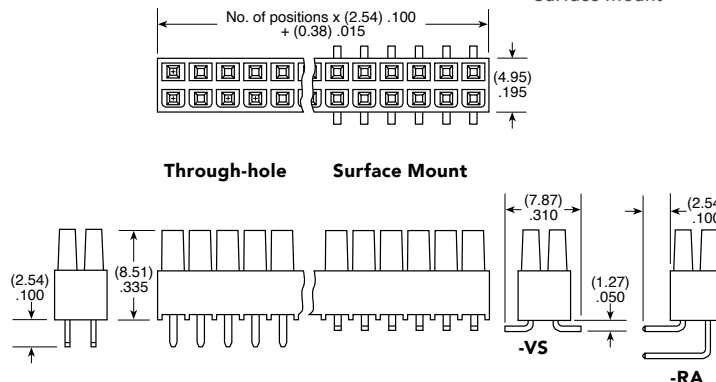

Note:
Some lengths, styles and options are non-standard, non-returnable.

View complete specifications at: samtec.com?IPT1 & samtec.com?IPS1

(4.19 mm) .165" PITCH • ISOLATED POWER CONNECTOR SET

IPBT	1	NO. OF POSITIONS PER ROW	LEAD STYLE	PLATING OPTION	ROW OPTION	OPTIONS
		02, 03, 04, 05, 08, 10 15 (-D Only) (Standard Sizes)	-H1 = Through-hole -H2 = Surface Mount	-T = Matte Tin	-S = Single Row -D = Double Row	-RA = Right-angle (Lead Style -H1 only) -GP = Guide Post Holes (Not available with -K) -K = Keyed Polarization (Not available with -GP option, is required callout if -GP not called out)

IPBT
Board Mates:
IPBS
Cable Mates:
PMMSD, PMSS

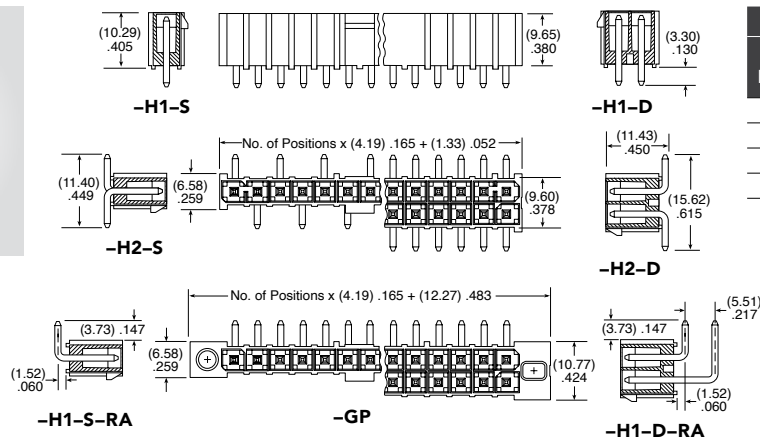
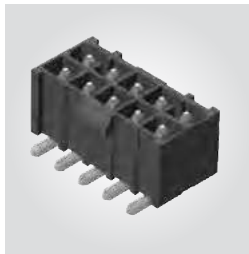

IPBT/IPBS	
PINS POWERED	CURRENT RATING (PER CONTACT)
2	10.3 A
4	8.4 A
6	7.6 A
8	7.1 A
30	6.0 A

IPBS	1	NO. OF POSITIONS PER ROW	LEAD STYLE	PLATING OPTION	ROW OPTION	OPTION
		02, 03, 04, 05, 08, 10 15 (-D Only) (Standard Sizes)	-01 = Standard Power -02 = Standard Power Surface Mount	-T = Matte Tin	-S = Single Row -D = Double Row	-GP = Guide Post

IPBS
Board Mates:
IPBT

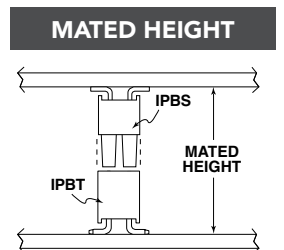
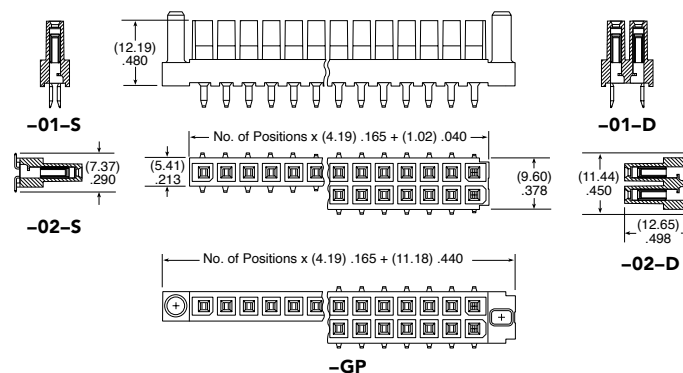
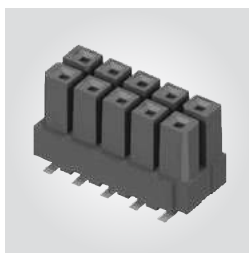

IPBT/IPBS LEAD STYLE	MATED HEIGHT*
H1/-01	(15.25) .600
-H2/-02	(16.84) .663

*Processing conditions will affect mated height.

Note:
Some lengths, styles and options are non-standard, non-returnable.

View complete specifications at: samtec.com?IPBT & samtec.com?IPBS

RUGGED I/O SYSTEMS

POWER I/O • MICRO-HYPERBOLOID CONTACT • SEALED CIRCULARS & RECTANGULARS



URSA I/O
ULTRA RUGGED CONTACT SYSTEM

212-215

URSA™ I/O ULTRA RUGGED POWER CABLE SYSTEMS

Socket Cables and Components (B1SD(T), B1SDS, IBT1, CC508)	213
Panel Mount Terminal Cables and Components (P1PD(T), P1PDS, IPP1, TC145)	214
Board Mount I/O Connector (P1M)	215

216-218

FLEXIBLE SEALED SYSTEMS

AccliMate™ IP67 & IP68 Sealed Circular & Rectangular Systems	216-218
--	---------

ULTRA RUGGED I/O SYSTEMS

(1.00 mm) .0394" PITCH



FEATURES & BENEFITS

MAX
2.9
A m p s

- Small form factor
- Four points of contact for a reliable connection and high mating cycles
- Up to 40 positions per row
- Cable-to-cable & cable-to-board solutions
- EMI shielding limits signal degradation and optimizes performance
- Through-hole or surface mount
- 28 & 30 AWG cable



Shown actual size at 20 total positions



Hyperboloid-type contact for extreme high mating cycles



Extreme density with up to 1,450 total I/Os in a 1RU panel (29 cables at 50 total I/Os each)

KEY SPECIFICATIONS (P1PD(X), B1SD(X) & P1M)

PITCH	INSULATOR MATERIAL	CONTACT MATERIAL	SHIELD MATERIAL	PLATING	OPERATING TEMP RANGE	CURRENT RATING	VOLTAGE RATING
1.00 mm	Liquid Crystal Polymer	Beryllium Copper	Zinc Alloy	Au over 50 μm (1.27 μm) Ni	-10 °C to +80 °C (PVC) -40 °C to +125 °C (*Teflon™ Fluoropolymer)	2.9 A per pin (2 pins powered)	253 VAC

*Teflon™ is a trademark of The Chemours Company FC, LLC used under license by Samtec.

(1.00 mm) .0394" PITCH • NON-PANEL MOUNT I/O CABLE/COMPONENTS

SERIES	NO. OF POSITIONS	WIRE GAUGE	COLOR CODE	PLATING	ASSEMBLED LENGTH	PINOUT
--------	------------------	------------	------------	---------	------------------	--------

B1SD
= Double Row
Non-Panel Mount
PVC Cable

**-10, -15,
-25, -30**
(Per Row)

-28
= 28 AWG

(Leave blank for standard wire)

-30
= 30 AWG

C
= Color Code Wire
(Not available with B1SDT)

-H
= 30 μ" (0.76 μm)
Gold on contact area,
Gold flash on tail

-"XX.X"
= Length in inches
06.0" (152.4 mm)
minimum

(Leave blank for
single ended)

-1
= Pin 1 to
Pin 1

-2
= Pin 1 to
Pin 2

-3
= Pin 1 to
Pin N

-4
= Pin 1 to
Pin N-1

B1SDT
= Double Row
Non-Panel Mount
Blue *Teflon™
Fluoropolymer Cable

B1SD, B1SDT
Cable Mates:
P1PD, P1PDT
Board Mates:
P1M

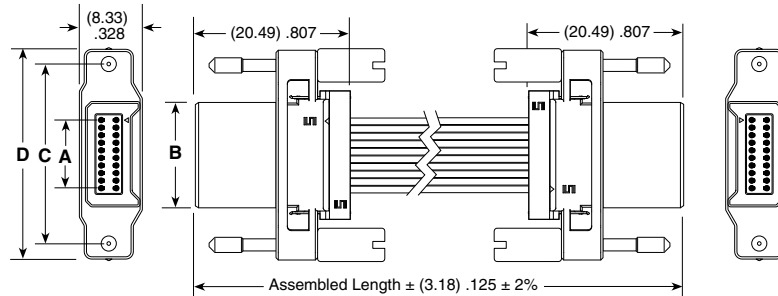

B1SDX-10-XXX-H-XX.X-3 SHOWN

NO. OF POSITIONS	A	B	C	D
-10	(9.00) .354	(13.94) .549	(23.75) .935	(27.75) 1.093
-15	(14.00) .551	(18.94) .746	(28.75) 1.132	(32.75) 1.289
-25	(24.00) .945	(28.94) 1.139	(38.75) 1.526	(42.75) 1.683
-30	(29.00) 1.142	(33.94) 1.336	(43.75) 1.722	(47.75) 1.880

*Teflon™ is a trademark of The Chemours Company FC, LLC used under license by Samtec.

Notes:
Teflon™ Fluoropolymer Cable is intended for crimp only. Contact Samtec for solderable cable applications.

Some lengths, styles and options are non-standard, non-returnable.

B1SD CABLE HOLDER (Required for use with IBT1)

SERIES	NUMBER OF POSITIONS
B1SDR	-10, -15, -25, -30

View complete specifications at: samtec.com?B1SD & samtec.com?B1SDT

B1SDS	NO. OF POSITIONS	N	OPTION
-------	------------------	---	--------

-10, -15, -25, -30

-CS
= Captive Screw

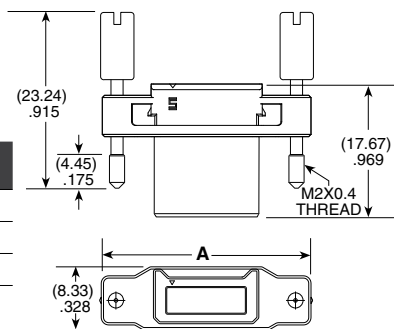
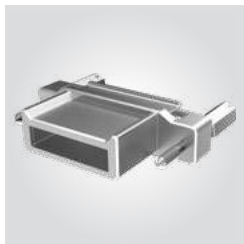

NO. OF POSITIONS	A
-10	(27.75) 1.093
-15	(32.75) 1.289
-25	(42.75) 1.683
-30	(47.75) 1.880

Note:
Some lengths, styles and options are non-standard, non-returnable.

TOOLING

Hand Tool: TBD

Mini Applicator: TBD

IBT1	NO. OF POSITIONS	1
------	------------------	---

-10, -15, -25, -30

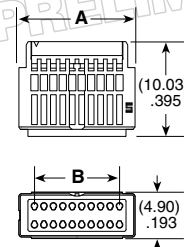

NO. OF POSITIONS	A	B
-10	(12.290) .484	(9.00) .354
-15	(17.290) .681	(14.00) .551
-25	(27.290) 1.074	(24.00) .945
-30	(32.290) 1.271	(29.00) 1.142

CC508	01	PLATING	PACKAGING
-------	----	---------	-----------

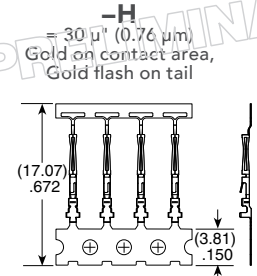
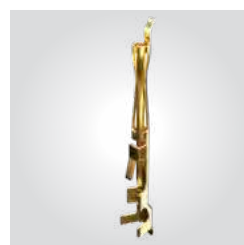

-R
= Full Reel
(25,000 Contacts Per Reel)

-M
= Mini Reel
(1,000 to 5,000 Contacts Per Reel)

-B
= Bubble Bag
(35 Contacts)

View complete specifications at: samtec.com?B1SDS, samtec.com?IBT1 & samtec.com?CC508

(1.00 mm) .0394" PITCH • PANEL MOUNT I/O CABLE/COMPONENTS

SERIES	NO. OF POSITIONS	WIRE GAUGE	COLOR CODE	PLATING	ASSEMBLED LENGTH	END OPTION	PINOUT
--------	------------------	------------	------------	---------	------------------	------------	--------

P1PD
= Double Row Panel Mount PVC Cable

P1PDT
= Double Row Panel Mount Blue *Teflon™ Fluoropolymer Cable

-10, -15, -25, -30
(Per Row)

-28
= 28 AWG
-30
= 30 AWG

(Leave blank for standard wire)
C
= Color Code Wire (Not available with P1PDT)

-H
= 30 μ" (0.76 μm) Gold on contact area, Gold flash on tail

-"XX.X"
= Length in inches 06.0" (152.4 mm) minimum

(Leave blank for single ended)

(Leave blank for single ended)

-B
= B1SD
-S
= SFSD

1
= Pin 1 to Pin 1
2
= Pin 1 to Pin 2
3
= Pin 1 to Pin N
4
= Pin 1 to Pin N-1

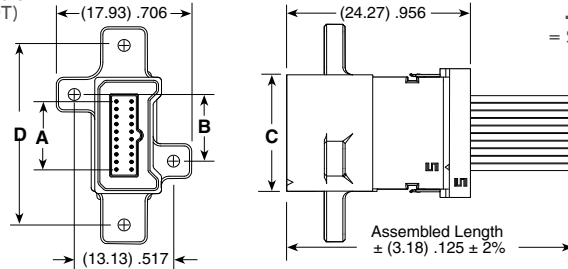

P1PDX-10-XXX-H-XX.X SHOWN

NO. OF POSITIONS	A	B	C	D
-10	(9.00) .354	(8.79) .346	(15.39) .606	(23.75) .935
-15	(14.00) .551	(13.79) .543	(20.39) .803	(28.75) 1.132
-25	(24.00) .945	(23.79) .937	(30.39) 1.196	(38.75) 1.526
-30	(29.00) 1.142	(28.79) 1.133	(35.39) 1.393	(43.75) 1.722

*Teflon™ is a trademark of The Chemours Company FC, LLC used under license by Samtec.

Notes:
Teflon™ Fluoropolymer Cable is intended for crimp only. Contact Samtec for solderable cable applications.

Some lengths, styles and options are non-standard, non-returnable.

P1PD, P1PDT
Cable Mates:
B1SD, B1SDT



PRELIMINARY

P1PD CABLE HOLDER (Required for use with IPP1)

SERIES	NUMBER OF POSITIONS
P1PDR	-10, -15, -25, -30

View complete specifications at: samtec.com?P1PD & samtec.com?P1PDT

P1PDS	NO. OF POSITIONS	N
-------	------------------	---

-10, -15, -25, -30

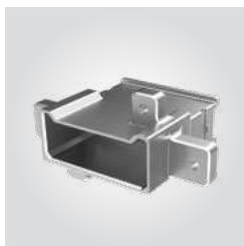

PRELIMINARY

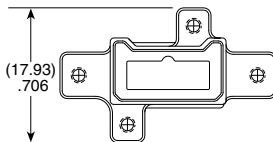
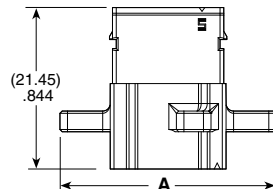

NO. OF POSITIONS	A
-10	(28.75) 1.132
-15	(33.75) 1.329
-25	(43.75) 1.722
-30	(48.75) 1.920

Note:
Some lengths, styles and options are non-standard, non-returnable.

TOOLING

Hand Tool: TBD

Mini Applicator: TBD

IPP1	NO. OF POSITIONS	1
------	------------------	---

-10, -15, -25, -30



PRELIMINARY

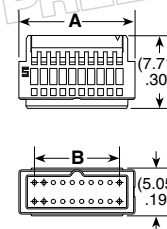

NO. OF POSITIONS	A	B
-10	(12.290) .484	(9.00) .354
-15	(17.290) .681	(14.00) .551
-25	(27.290) 1.074	(24.00) .945
-30	(32.290) 1.271	(29.00) 1.142

TC145	01	PLATING	PACKAGING
-------	----	---------	-----------



PRELIMINARY

-H
= 30 μ" (0.76 μm) Gold on contact area, Gold flash on tail

-R
= Full Reel (25,000 Terminals Per Reel)

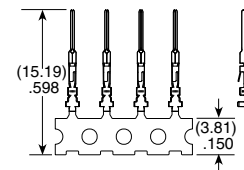

-M
= Mini Reel (1,000 to 5,000 Terminals Per Reel)

-B
= Bubble Bag (35 Terminals)

View complete specifications at: samtec.com?P1PDS, samtec.com?IPP1 & samtec.com?TC145

(1.00 mm) .0394" PITCH • I/O BOARD MOUNT

P1M	NO. OF POSITIONS	LEAD STYLE	PLATING	D	RA	PIN LENGTH	"X"R
-----	------------------	------------	---------	---	----	------------	------

**-10, -15,
-25, -30**
(Per Row)

-01
= Surface Mount

-02
= Through-hole
(1.57 mm PCB)

-03
= Through-hole
(2.36 mm PCB)

-S
= 30 μ" (0.76 μm)
Gold on contact area,
Matte Tin on tail

-STL
= 30 μ" (0.76 μm)
Gold on contact area,
Tin/Lead on tail

(Leave blank for standard)

-H
= Hot Swap

-TR
= Tape & Reel

-FR
= Full Reel
Tape & Reel
(must order max.
quantity per reel;
contact Samtec for
quantity breaks)

PRELIMINARY

P1M
Cable Mates:
B1SD, B1SDT

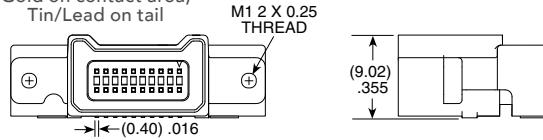

**P1M-10-01-S-D-RA SHOWN
(SURFACE MOUNT)**

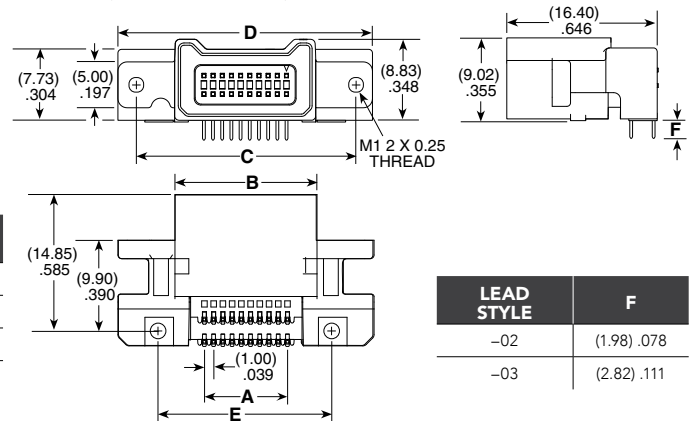

**P1M-10-02-S-D-RA SHOWN
(THROUGH-HOLE)**

NO. OF POSITIONS	A	B	C	D	E
-10	(9.00) .354	(15.39) .606	(23.75) .935	(27.75) 1.093	(18.80) .740
-15	(14.00) .551	(20.39) .803	(28.75) 1.132	(32.75) 1.289	(23.80) .937
-25	(24.00) .945	(30.39) 1.196	(38.75) 1.526	(42.75) 1.683	(33.80) 1.331
-30	(29.00) 1.142	(35.39) 1.393	(43.75) 1.722	(47.75) 1.880	(38.80) 1.528

LEAD STYLE	F
-02	(1.98) .078
-03	(2.82) .111

Note:
Some lengths, styles and options are non-standard, non-returnable.

View complete specifications at: samtec.com?P1M

P1M	NO. OF POSITIONS	LEAD STYLE	PLATING	DV	PIN LENGTH	PICK & PLACE OPTION	"X"R
-----	------------------	------------	---------	----	------------	---------------------	------

**-10, -15, -25,
-30**
(Per Row)

-01
= Surface Mount

-02
= Through-hole
(1.57 mm PCB)

-03
= Through-hole
(2.36 mm PCB)

-S
= 30 μ" (0.76 μm)
Gold on contact area,
Matte Tin on tail

-STL
= 30 μ" (0.76 μm)
Gold on contact area,
Tin/Lead on tail

(Leave blank for standard)

-H
= Hot Swap

(Leave blank for no pad)

-K
= (8.25 mm) .315"
DIA Polyimide
Film Pick &
Place Pad

-TR
= Tape & Reel

-FR
= Full Reel
Tape & Reel
(must order max.
quantity per reel;
contact Samtec for
quantity breaks)

P1M
Cable Mates:
B1SD, B1SDT



PRELIMINARY

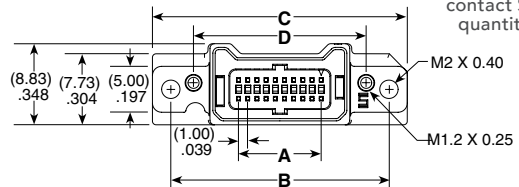

P1M-10-01-S-DV SHOWN

NO. OF POSITIONS	A	B	C	D	E
-10	(9.00) .354	(23.75) .935	(27.75) 1.093	(18.80) .740	(15.22) .599
-15	(14.00) .551	(28.75) 1.132	(32.75) 1.289	(23.80) .937	(20.22) .796
-25	(24.00) .945	(38.75) 1.526	(42.75) 1.683	(33.80) 1.331	(30.22) 1.190
-30	(29.00) 1.142	(43.75) 1.722	(47.75) 1.880	(38.80) 1.528	(35.22) 1.387

Note:
Some lengths, styles and options are non-standard, non-returnable.

View complete specifications at: samtec.com?P1M

ACCLIMATE™

RUGGED SEALED I/O SYSTEMS



FEATURES & BENEFITS

- Meets IP68 & IP67 requirements for dust and waterproof sealing
- Ideal for high reliability in harsh environments
- Bayonet circulars in 12 mm, 16 mm and 22 mm shell sizes with choice of pin configuration and gender (ACX)
- Lightweight plastic mini push-pull system in a small form factor for increased panel density (MCP/MCR)
- Threaded sealed circular systems available with USB or Ethernet
- Rectangular systems offer a 25-45% panel area savings
- Rugged dust caps available

KEY SPECIFICATIONS

SERIES	TYPE	INSULATOR MATERIAL	TERMINAL MATERIAL	CONTACT MATERIAL	OPERATING TEMP RANGE
ACP-12/ACR-12	Bayonet Circular	Thermoplastic	Brass	Brass/BeCu	-10 °C to +80 °C
ACP-16/ACR-16					-10 °C to +105 °C
ACP-22/ACR-22					-10 °C to +105 °C
MCP/MCR	Mini Push-Pull	PPS	Phosphor Bronze	Phosphor Bronze	-20 °C to +80 °C
BCU/BPCU/BRU	Threaded Circular	Thermoplastic	--	Copper Alloy	-40 °C to +80 °C
SCRUS/SCRES		PBT	--	Phosphor Bronze	-20 °C to +75 °C (SCRUS) -40 °C to +70 °C (SCRES)
RPBE/RPCE		Rectangular	Black LCP (RPBE)	--	Phosphor Bronze
RPBU/RPCU	Glass Filled Thermoplastic (RPCE)		--	Phosphor Bronze	-20 °C to +80 °C
		Black LCP	--	Phosphor Bronze	-20 °C to +80 °C

IP68 SEALED BAYONET CIRCULAR - 12 mm SHELL



Series	Gender	Current Carrying Capacity	Housing	Web Address
ACP-12	Terminal	MAX 5.0 A m p s	Metal or Plastic	samtec.com?acp-12
ACR-12	Socket			samtec.com?acr-12

Kitted components available for field assembly, visit samtec.com/acpk-12 or samtec.com/acrk-12

IP68 SEALED BAYONET CIRCULAR - 16 mm SHELL



Series	Gender	Current Carrying Capacity	Housing	Web Address
ACP-16	Terminal	MAX 11.6 A m p s	Metal or Plastic	samtec.com?acp-16
ACR-16	Socket			samtec.com?acr-16

Kitted components available for field assembly, visit samtec.com/acpk-16 or samtec.com/acrk-16

IP68 SEALED BAYONET CIRCULAR - 22 mm SHELL



Series	Gender	Current Carrying Capacity	Housing	Web Address
ACP-22	Terminal	MAX 8.3 A m p s	Metal or Plastic	samtec.com?acp-22
ACR-22	Socket			samtec.com?acr-22

Kitted components available for field assembly, visit samtec.com/acpk-22 or samtec.com/acrk-22

IP67 SEALED MINI PUSH-PULL - 8 SERIES



Series	Gender	Current Carrying Capacity	Housing	Web Address
MCP	Terminal	MAX 3.4 A m p s	Plastic	samtec.com?mcp
MCR	Socket			samtec.com?mcr

Dust caps: DCA-MCR-8 and DCA-MCP-8

IP67 THREADED CIRCULAR SYSTEM - USB TYPE C



Series	Gender	Current Carrying Capacity	Housing	Web Address
BCU	Terminal (Cable)	Supports 100 W power delivery (5 A @ 20 V)	Plastic	samtec.com?bcu
BPCU	Socket (Cable)			samtec.com?bpcu
BRU	Socket (Board Mount)			samtec.com?bru

Dust cap: DCA-BRU-C-01

IP68 SEALED THREADED CIRCULAR SYSTEM - USB TYPE A/B & ETHERNET



Series	Gender	Current Carrying Capacity	Housing	Mates With	Web Address
SCRUS	Socket (USB)	4.3 Amps MAX	Plastic	SCPU	samtec.com?scrus
SCRES	Socket (Ethernet)	3.8 Amps MAX		SCPE	samtec.com?scres

Dust caps: DCA-17-03, DCA-17-01 and SCPPA-17-01 (panel plug)

IP68 SEALED RECTANGULAR SYSTEM - ETHERNET



Series	Gender	Housing	Mates With	Web Address
RPBE	Socket	Plastic	RCE	samtec.com?rpbe
RPCE	Socket		RCE	samtec.com?rpce

Dust caps: DCA-RPBE-01-01-P (no latch) and DCA-RPBE-XX-01-L (latching)

IP68 SEALED RECTANGULAR SYSTEM - USB TYPE A/B



Series	Gender	Current Carrying Capacity	Housing	Mates With	Web Address
RPBU	Socket	4.5 Amps MAX	Plastic	RCU (Single Port Only)	samtec.com?rpbu
RPCU	Socket			RCU	samtec.com?rpcu

Dust caps: DCA-RPBU-XX-01-X

RUGGED TIGER EYE™ SYSTEMS

HIGH-RELIABILITY • MULTI-FINGER BeCu CONTACT • HIGH MATING CYCLES



220-225

.050" (1.27 mm) PITCH TIGER EYE™ SYSTEMS

Standard Pitch Sockets & Terminals (SFM, TFM)	220-222
Cost-Effective Tiger Eye™ Lite Sockets & Terminals (SFC, TFC)	223
Quad Row Strips (MOLC, FOLC)	224
Flexible Pin Count Tiger Eye™ Sockets (SFMC)	225

226-227

0.80 mm PITCH TIGER EYE™ SYSTEMS

Micro Pitch Sockets & Terminals (SEM, SEMS, TEM, TEMS)	226-227
--	---------

228-230

2.00 mm PITCH TIGER EYE™ SYSTEMS

2.00 mm Pitch Sockets & Terminals (S2M, T2M)	228-229
2.00 mm Pitch Flex Stack & IDC Cable Socket (SMM)	230

RUGGED TIGER EYE™ SYSTEMS

(1.27 mm) .050" PITCH

MAX
3.2
Amps

8
Gbps

FEATURES & BENEFITS

- Screw down, locking clip, friction latching and weld tab ruggedizing options
- Shrouded, polarized and keyed
- Surface mount or through-hole tails
- High-density, four row design (FOLC/MOLC Series)
- Discrete wire assemblies available in single or double row, 28 and 30 AWG PVC or *Teflon™ Fluoropolymer (See pages 238-239). Contact asp@samtec.com for custom solutions.
- Cable components (ISDF/CC03) and tooling available: samtec.com/tooling
- Severe Environment Testing qualified (SFM/TFM); aligns with MIL-DTL-55302. Visit samtec.com/set

*Teflon™ is a trademark of The Chemours Company FC, LLC used under license by Samtec.

KEY SPECIFICATIONS

SERIES	STACK HEIGHTS	INSULATOR MATERIAL	CONTACT MATERIAL	PLATING	OPERATING TEMP RANGE	CURRENT RATING	VOLTAGE RATING	MAX. CYCLES	LEAD-FREE SOLDERABLE
SFM/TFM	6 to 12 mm	Black LCP	BeCu (SFM) Phosphor Bronze (TFM)	Au or Sn over 50 μ" (1.27 μm) Ni	-55 °C to +125 °C	3.2 A per pin (2 pins powered)	250 VAC	10,000 with 30 μ" (0.76 μm) Au	Yes
SFC/TFC	6 to 12 mm	Black LCP	Phosphor Bronze	Au or Sn over 50 μ" (1.27 μm) Ni	-55 °C to +125 °C	3.1 A per pin (2 pins powered)	350 VAC	(Call Samtec for E.L.P.™ plating option)	Yes

**TIGER™
EYE**
CONTACT



IDC cable assemblies with rugged strain relief (FFSD/FFMD, FFTP/FMTP)

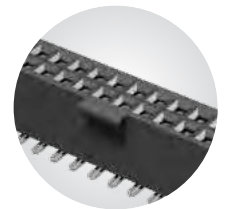

Locking for increased unmating force (SFML/TFML)

(1.27 mm) .050" PITCH • SMT/THROUGH-HOLE SOCKET

SERIES	1	NO. PINS PER ROW	LEAD STYLE	PLATING OPTION	ROW OPTION	OPTIONS
SFM = Standard		03, 04, 06, 08 (SFM only)	(Surface Mount) (Through-hole)	-L = 10 μm (0.25 μm) Gold on contact, Matte Tin on tail (Call Samtec for E.L.P.™ plating option)	-S = Single Row (SFM only)	Specify only -A, -LC or -DS (Not available with -DH, -SH)
SFML = Locking		05, 07, 10, 15, 20, 25, 30, 35, 40, 45, 50 (Standard sizes)	-02 = Tiger Eye™ Contact (BeCu)	-01, -03 = Tiger Eye™ Contact (BeCu)	-D = Double Row	Specify only -K or -P (Lead styles -02, -L2, -T2 only)
			-L2 = Low Insertion Force Tiger Eye™ Contact (BeCu)	-L1, -L3 = Low Insertion Force Tiger Eye™ Contact (BeCu)	-SH = Single Horizontal (05 thru 30 positions only) (SFM only) (Lead style -02 only)	-A = Alignment Pin
			-T2 = Tiger Eye™ LITE Contact (Phosphor Bronze)	-T1 = Tiger Eye™ LITE Contact (Phosphor Bronze)	-DH = Double Horizontal (05 thru 30 positions only) (SFM only) (Lead style -02 only)	-LC = Locking Clip (Manual placement required)
						-DS = Dual Screw Down for (1.60 mm) .062" PCB (05 thru 40 positions only) (Lead styles -01, -02 & -03 only) (Requires -D row option) (Not available with SFML) (Mates with TFM-DS option) (Not available with -A, -LC, -K, -P, -XR)
						-K = Polyimide film Pick & Place Pad (Not available with -DH, -SH)
						-P = Plastic Pick & Place Pad (Not available with -DH, -SH)
						Specify -TR or -FR last; Required for -DH & -SH. (Lead styles -02, -L2 & -T2 only)
						-TR = Tape & Reel
						-FR = Full Reel Tape & Reel (must order max. quantity per reel; contact Samtec for quantity breaks)

SFM
Board Mates:
TFM
Cable Mates:
TFSD, TFSS

SFML
Board Mates:
TFML
Cable Mates:
TFSD

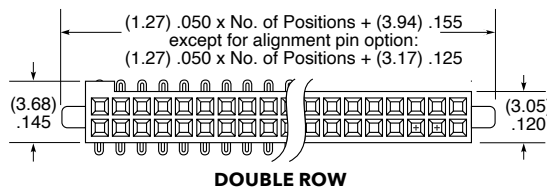
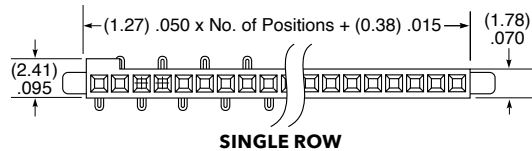

LEAD STYLE	A	B
-01, -L1, -T1	(3.05) .120	(0.51) .020
-03, -L3	(1.91) .075	(0.41) .016

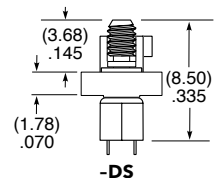
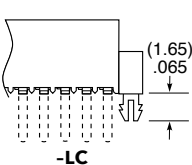
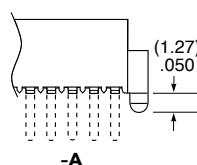
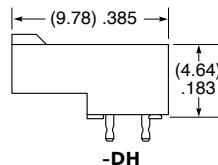
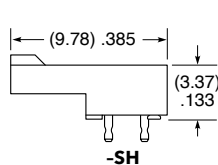
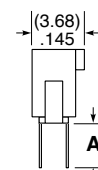
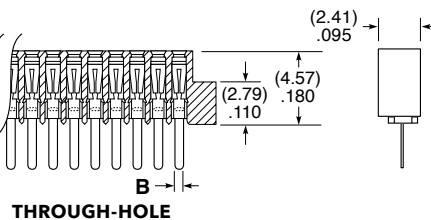
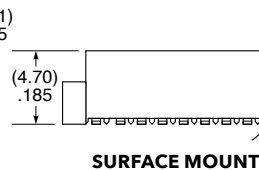
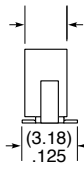
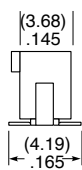

Notes:
Severe Environment Testing qualified (SFM); aligns with MIL-DTL-55302. Visit samtec.com/set

Some lengths, styles and options are non-standard, non-returnable.

View complete specifications at: samtec.com?SFM & samtec.com?SFML

(1.27 mm) .050" • SMT/THROUGH-HOLE HEADER

SERIES	1	NO. PINS PER ROW	LEAD STYLE	PLATING OPTION	ROW OPTION	OPTIONS
--------	---	------------------	------------	----------------	------------	---------

TFM
= Standard

TFML
= Locking (-01 & -02 lead style only)

03, 04, 06, 08
(TFM -01 & -02 only)

05, 07, 10, 15, 20, 25, 30, 35, 40, 45, 50
(Standard sizes)

Specify **LEAD STYLE** from chart

-L
= 15 μm (0.38 μm)
Gold on post, Matte Tin on tail (Call Samtec for E.L.P.™ plating option)

-S
= Single Row (TFM only)

-D
= Double Row

-DH*
= Double Horizontal (TFM lead style -02 only) (05 thru 50 positions only) (-TR or -FR option only available)

Specify only -RA, -RE1 or -RE2

-RA
= Right-angle (Lead style -01 only)

-RE1
= Right-angle Elevated for (1.60 mm) .062" PCB (Requires TFM lead style -01, -D row and -WT)

-RE2
= Right-angle Elevated for (2.36 mm) .093" PCB (Requires TFM lead style -01, -D row and -WT)

Specify only -A, -LC, -DS or -WT
Not available with -RA, -RE1 and -RE2 unless otherwise noted.

-A
= Alignment Pin

-LC
= Locking Clip (Manual Placement required)

-DS
= Dual Screw Down for (1.60 mm) .062" PCB (05, 07, 10, 15, 20, 25, 30, 35, 40 positions only) (TFM lead styles -01 and -02 only) (Requires -D row option) (Mates with SFM-DS option and SFSD/SFSDT -SS and -DS option only) (Not available with -A, -LC, -WT, -K, -P, -XR)

-WT
= Weld Tab (TFM lead styles -01 and -02 only) (Required callout for -RE1 & -RE2) (Mates to SFSS/SFSD -SR and -DR option only) (05, 07, 10, 15, 20, 25, 30, 35, 40, 45, 50 positions only)

SMT lead styles only
Specify only -K or -P

-K
= Polyimide Film Pick & Place Pad

-P
= Plastic Pick & Place Pad (5 positions min.) (Not available with 5 position with -WT)

Specify -TR or -FR last (Not available with -DS)

-TR
= Tape & Reel

-FR
= Full Reel Tape & Reel (must order max. quantity per reel; contact Samtec for quantity breaks)

TFM

Board Mates: SFM, SFMC
Cable Mates: SFSD, SFSS



TFML

Board Mates: SFML
Cable Mates: SFSD, TFSD, TFSD (-T end option)

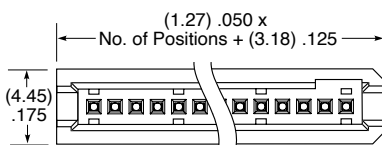

SINGLE ROW

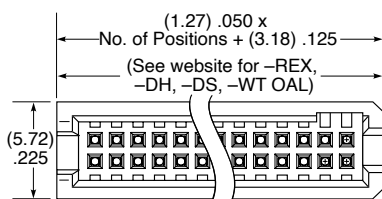

DOUBLE ROW

MATED HEIGHTS*		
LEAD STYLE (SMT)		MATED HEIGHT*
TFM	SFM	
-02	-02	(6.35) .250
-12		(8.13) .320
-22		(9.91) .390
-32		(11.81) .465
LEAD STYLE (T/H)		MATED HEIGHT*
TFM	SFM	
-01	-01	(5.97) .235
-03		(5.97) .235
-11		(7.75) .305
-13		(7.75) .305
-21		(9.53) .375
-23		(9.53) .375
-31		(11.43) .450

*Processing conditions will affect mated height.

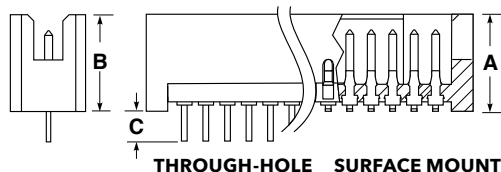

THROUGH-HOLE SURFACE MOUNT

LEAD STYLE (SMT)	A
-02	(5.72) .225
-12*	(7.49) .295
-22*	(9.27) .365
-32*	(11.18) .440

* N/A with 07, -DH or -S row option

LEAD STYLE (T/H)	B	C
-01	(5.59) .220	(1.97) .078
-03*	(5.59) .220	(2.77) .109
-11*	(7.37) .290	(1.97) .078
-13*	(7.37) .290	(2.77) .109
-21*	(9.14) .360	(1.97) .078
-23*	(9.14) .360	(2.77) .109
-31*	(11.05) .435	(1.97) .078

* Not Available with 07 or -S row option

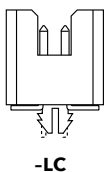

-LC

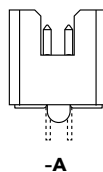

-A

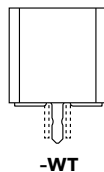

-WT

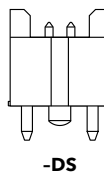

-DS

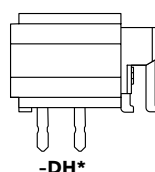

-DH*

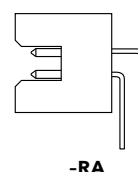

-RA

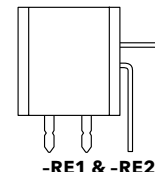

-RE1 & -RE2

Notes:

Severe Environment Testing qualified (TFM); aligns with MIL-DTL-55302. Visit samtec.com/set

Some lengths, styles and options are non-standard, non-returnable.

View complete specifications at: samtec.com?TFM & samtec.com?TFML

(1.27 mm) .050" PITCH • COST-EFFECTIVE HEADER/SOCKET

SFC	1	NO. PINS PER ROW	LEAD STYLE	PLATING OPTION	D	OPTIONS
		04, 05, 10, 15, 20, 25, 30, 35, 40, 45, 50 (Standard sizes)	-T1 = Through-hole Tiger Eye™ LITE -T2 = Surface Mount Tiger Eye™ LITE	-F = Gold flash on contact, Matte Tin on tail -L = 10 μ" (0.25 μm) Gold on contact, Matte Tin on tail		-A = Alignment Pin -K = (4.00 mm) .157" DIA Polyimide film Pick & Place Pad -TR = Tape & Reel (-T2 only) -FR = Full Reel Tape & Reel (must order max. quantity per reel; contact Samtec for quantity breaks) (-T2 only)

SFC
Board Mates:
TFC
Cable Mates:
TFS, TFSDT

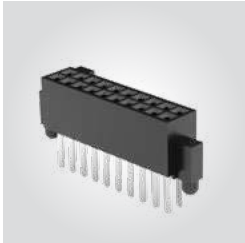
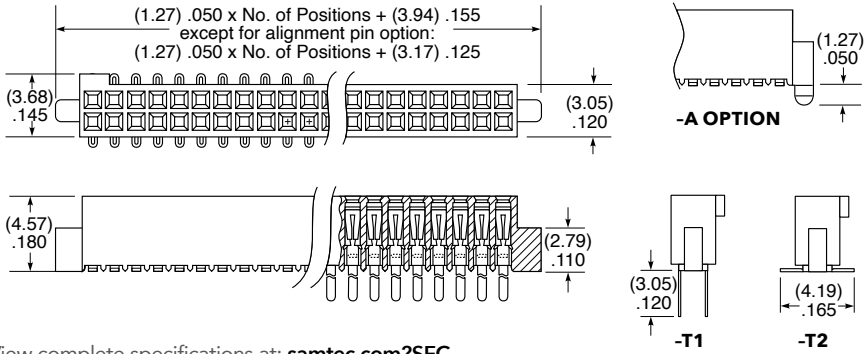
View complete specifications at: samtec.com?SFC

TFC	1	NO. PINS PER ROW	LEAD STYLE	PLATING OPTION	D	OPTIONS
		03, 04, 06, 08 (Lead Style -01 & -02 only) 05, 07, 10, 15, 20, 25, 30, 35, 40, 45, 50 (Standard sizes)	-X1 = Through-hole -X2 = Surface Mount	-F = Gold flash on post, Matte Tin on tail -L = 15 μ" (0.38 μm) Gold on post, Matte Tin on tail		-RA = Right-angle (-01 only) -A = Alignment Pin -LC = Locking Clip (Manual Placement required) (not available with -RA) -K = (6.75 mm) .266" DIA Polyimide film Pick & Place Pad (not available with -RA) -P = Plastic Pick & Place Pad (5 positions min.) (not available with -RA) -TR = Tape & Reel (-X2 only) (not available with -RA) -FR = Full Reel Tape & Reel (must order max. quantity per reel; contact Samtec for quantity breaks) (-X2 only) (not available with -RA)

TFC
Board Mates:
SFC
Cable Mates:
SFS, SFSDT

SMT LEAD STYLE	A	B	TH LEAD STYLE	A	B
-02	(5.72) .225	(3.38) .133	-01	(5.59) .220	(3.38) .133
-12	(7.49) .295		-11	(7.37) .290	
-22	(9.27) .365	(3.30) .130	-21	(9.14) .360	(3.30) .130
-32	(11.18) .440		-31	(11.05) .435	

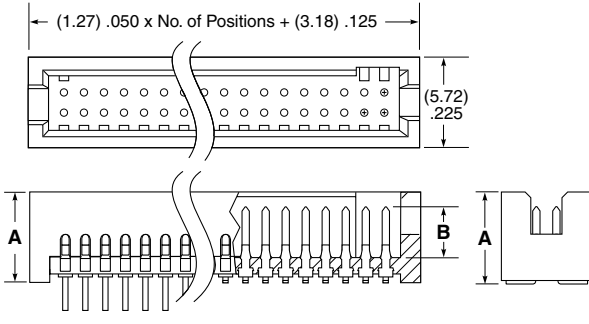
Note:
Some lengths, styles and options are non-standard, non-returnable.

View complete specifications at: samtec.com?TFC

QUAD ROW TERMINAL/SOCKET

(1.27 mm) .050" PITCH • FOLC/MOLC SERIES



FOLC
Board Mates:
MOLC

MOLC
Board Mates:
FOLC

FOLC	1	NO. PINS PER ROW	LEAD STYLE	PLATING OPTION	Q	OPTION	PACKAGING
------	---	------------------	------------	----------------	---	--------	-----------

20, 25,
30, 35,
40, 45, 50
(Standard sizes)

-01 & -04
= Through-hole
-M1 & -M2
= Mixed Technology
-L1 & -L4
= Low Insertion Force Through-hole

-L
= 10 μm
(0.25 μm)
Gold on contact,
Matte Tin on tail

-LC
= Locking Clip
(Manual placement required)

Leave blank for tubes
-TR
= Tape & Reel (-MX only)
-FR
= Full Reel Tape & Reel (must order max. quantity per reel; contact Samtec for quantity breaks) (-MX only)

SPECIFICATIONS

Insulator Material:
Black Liquid Crystal Polymer
Contact Material (FOLC):
BeCu
Terminal Material (MOLC):
Phosphor Bronze
Plating:
Au or Sn over
50 μm (1.27 μm) Ni
Current Rating:
2.6 A per pin
(4 pins powered)
Operating Temp Range:
-55 °C to +125 °C
Voltage Rating:
165 VAC/230 VDC
Insertion Depth (FOLC):
(3.30 mm) .130" to
(4.06 mm) .160"
Max Cycles (FOLC):
100

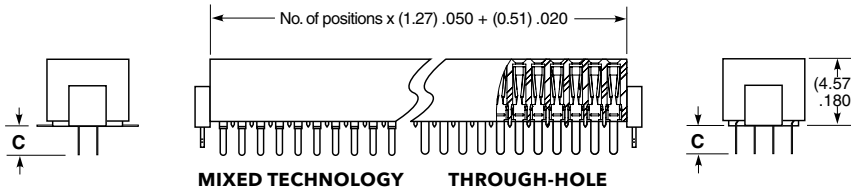
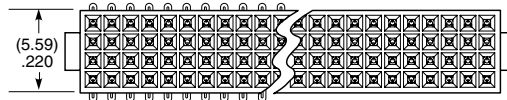

LEAD STYLE	C
-01, -M1	(1.91) .075
-04, -M2	(3.04) .120

View complete specifications at: samtec.com?FOLC

PROCESSING

Lead-Free Solderable:
Yes
SMT Lead Coplanarity (MOLC):
(0.10 mm) .004" max (20-25)
(0.15 mm) .006" max (30-50)*
*(.004" stencil solution may be available; contact ipg@samtec.com)

MOLC	1	NO. PINS PER ROW	LEAD STYLE	PLATING OPTION	Q	OPTION	PACKAGING
------	---	------------------	------------	----------------	---	--------	-----------

20, 25,
30, 35,
40, 45, 50
(Standard sizes)

-X'1
= Through-hole (Specify from chart)
-02
= Surface Mount
-M1
= Mixed Technology

-L
= 10 μm
(0.25 μm)
Gold on post,
Matte Tin on tail

-LC
= Locking Clip (Manual placement required)
-P
= Pick & Place Pad (-02 only)

Leave blank for tubes
-TR
= Tape & Reel (-02 & -M1 only)
-FR
= Full Reel Tape & Reel (must order max. quantity per reel; contact Samtec for quantity breaks) (-02 & -M1 only)

APPLICATIONS

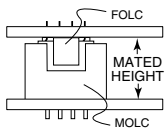

LEAD STYLE		MATED HEIGHT*
MOLC	FOLC	
-01		(5.97) .235
-11	-01	(7.75) .305
-31		(11.43) .450

*Processing conditions will affect mated height.

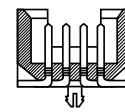
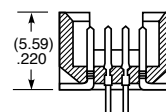
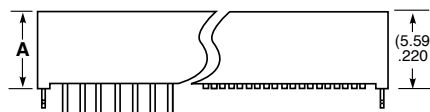
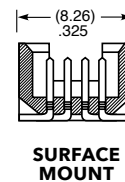
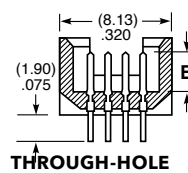
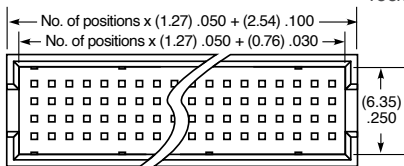

LEAD STYLE	A	B
-01	(5.59) .220	(3.38) .133
-11	(7.34) .289	(3.66) .144
-31	(11.05) .435	

View complete specifications at: samtec.com?MOLC

FLEXIBLE PIN COUNT TIGER EYE™ SOCKET

(1.27 mm) .050" PITCH • SFMC SERIES

MAX
2.9
A m p s

8
G b p s

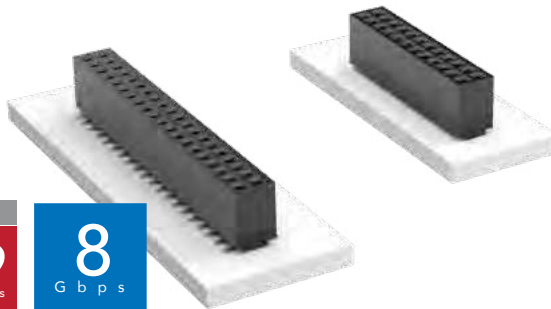

SFMC
Board Mates:
TFM

Cable Mates:
FMTP, FFMD*

*Note: Standard FFMD callout will not mate with FLE, SFMC. Must use gold plated callouts. (See drawing on web.)

SFMC	1	NO. PINS PER ROW	LEAD STYLE	PLATING OPTION	D	OPTIONS
------	---	------------------	------------	----------------	---	---------

02 thru 50

-01, -03
= Through-hole

-L1, -L3
= Low Insertion Force Through-hole

-02
= Surface Mount

-L2
= Low Insertion Force Surface Mount

-T1
= Through-hole Tiger Eye™ LITE

-T2
= Surface Mount Tiger Eye™ LITE

-L
= 10 μ" (0.25 μm) Gold on contact, Matte Tin on tail

-K
= (4.00 mm) .157" DIA Polyimide film Pick & Place Pad (4 positions min.)

-P
= Plastic Pick & Place Pad (5 positions min.)

-TR
= Tape & Reel

-FR
= Full Reel Tape & Reel (must order max. quantity per reel; contact Samtec for quantity breaks)

SPECIFICATIONS

Insulator Material:
Black Liquid Crystal Polymer

Contact Material:
Tiger Eye™ = BeCu
Tiger Eye™ LITE = Phosphor Bronze

Plating:
Au or Sn over 50 μ" (1.27 μm) Ni

Current Rating:
2.9 A per pin (2 pins powered)

Voltage Rating:
220 VAC/310 VDC

Operating Temp Range:
-55 °C to +125 °C

Insertion Depth:
(3.05 mm) .120" to (4.06 mm) .160"

Max Cycles:
10,000 with 30 μ" (0.76 μm) Au

PROCESSING

Lead-Free Solderable:
Yes

SMT Lead Coplanarity:
(0.10 mm) .004" max (02-26)
(0.15 mm) .006" max (27-50)*
*(.004" stencil solution may be available; contact ipg@samtec.com)

ALSO AVAILABLE

Other plating (MOQ Required)

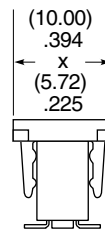
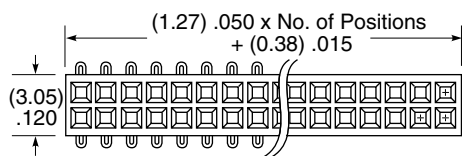

-P OPTION

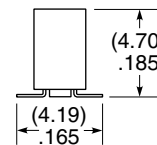
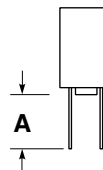
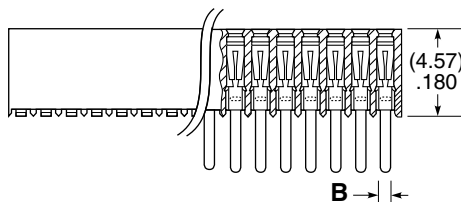

LEAD STYLE	A	B
-01, -L1, -T1	(3.05) .120	(0.51) .020
-03, -L3	(1.91) .075	(0.41) .016

Note:
Some lengths, styles and options are non-standard, non-returnable.

View complete specifications at: samtec.com?SFMC

RUGGED TIGER EYE™ SYSTEMS

(0.80 mm) .0315" PITCH



FEATURES & BENEFITS

- High-reliability, multi-finger BeCu contact
- Micro pitch and slim body for space savings
- 6 mm, 7 mm and 10 mm stack heights
- Locking clip, alignment pins and weld tab ruggedizing features
- Rugged latching system for increased withdrawal force
- Vertical and right-angle mating headers
- Discrete wire assembly available with 32 AWG *Teflon™ Fluoropolymer (See page 241). Contact asp@samtec.com for custom solutions.
- Extended Life Product™ testing available

*Teflon™ is a trademark of The Chemours Company FC, LLC used under license by Samtec.

MAX
2.9
A m p s

8
G b p s

TIGER™
EYE
CONTACT



Locking for increased unmating force
(Visit samtec.com?SEML for more information)



Components (ISDE/CC396) and tooling available:
samtec.com/tooling

KEY SPECIFICATIONS (SEM/TEM)

STACK HEIGHTS	INSULATOR MATERIAL	CONTACT MATERIAL	PLATING	OPERATING TEMP RANGE	CURRENT RATING	MAX. CYCLES	VOLTAGE RATING	LEAD-FREE SOLDERABLE
6 - 10 mm	Black LCP	BeCu (SEM) Phosphor Bronze (TEM)	Au or Sn over 50 μ" (1.27 μm) Ni	-55 °C to +125 °C	2.9 A per pin (2 pins powered)	100 with 10 μ" (0.25 μm) Au	235 VAC/330 VDC	Yes

(0.80 mm) .0315" PITCH • MICRO TIGER EYE™ SOCKET AND HEADER

SERIES	1	NO. PINS PER ROW	02	STACK HEIGHT	PLATING OPTION	D	OPTIONS	OTHER OPTIONS
SEM Socket		05, 10, 15, 20, 25 (SEM, SEMS, TEM, TEMS only)		-03.0 = 6 mm Stack Height (-03.0 required for SEM/SEMS Series)	-FG = Gold Flash		Leave blank for SEMS/TEMS	-K = (3.50 mm) .138" DIA Polyimide film Pick & Place Pad (Required for SEMS)
SEMS Slim Socket		30, 35, 40, 45, 50 (SEM/TEM only) (Standard sizes)		-04.0 = 7 mm Stack Height (TEM/TEMS only)	-G = 10 μ" (0.25 μm) Gold on contact, Gold Flash on tail		-A = Alignment Pin (Not available with -LC or -WT)	= (5.50 mm) .217" DIA Polyimide film Pick & Place Pad (Required for TEMS)
TEM Header				-07.0 = 10 mm Stack Height (TEM/TEMS only)	-H = 30 μ" (0.76 μm) Gold on contact, Gold Flash on tail		-LC = Locking Clip (Not available with -A or -WT) (Manual placement required)	-TR = Tape & Reel
TEMS Slim Header							-WT = Weld Tab (Not available with -A or -LC)	-FR = Full Reel Tape & Reel (must order max. quantity per reel; contact Samtec for quantity breaks)

SEM
Board Mates:
TEM

SEMS
Board Mates:
TEMS

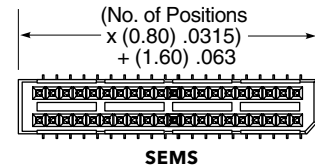
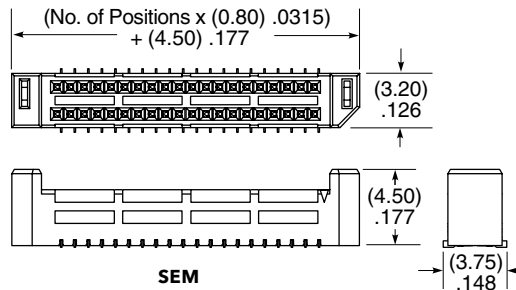

View complete specifications at: samtec.com?SEM & samtec.com?SEMS

TEM
Board Mates:
SEM, SEML

TEMS
Board Mates:
SEMS

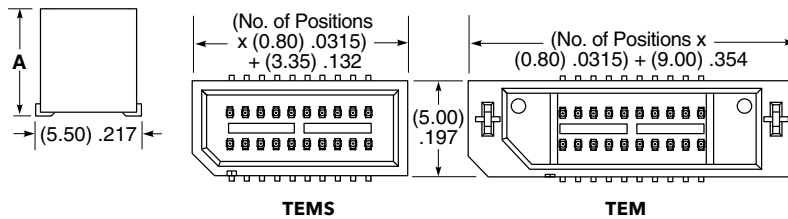

MATED HEIGHTS		
STACK HEIGHT	A	MATED HEIGHT*
-03.0	(5.610) .2209	6 mm
-04.0	(6.610) .2602	7 mm
-07.0	(9.610) .3783	10 mm

*Processing conditions will affect mated height.

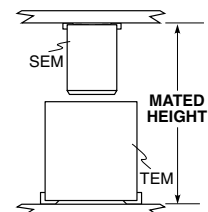

Note:
Some lengths, styles and options are non-standard, non-returnable.

View complete specifications at: samtec.com?TEM & samtec.com?TEMS

RUGGED TIGER EYE™ SYSTEMS

(2.00 mm) .0787" PITCH

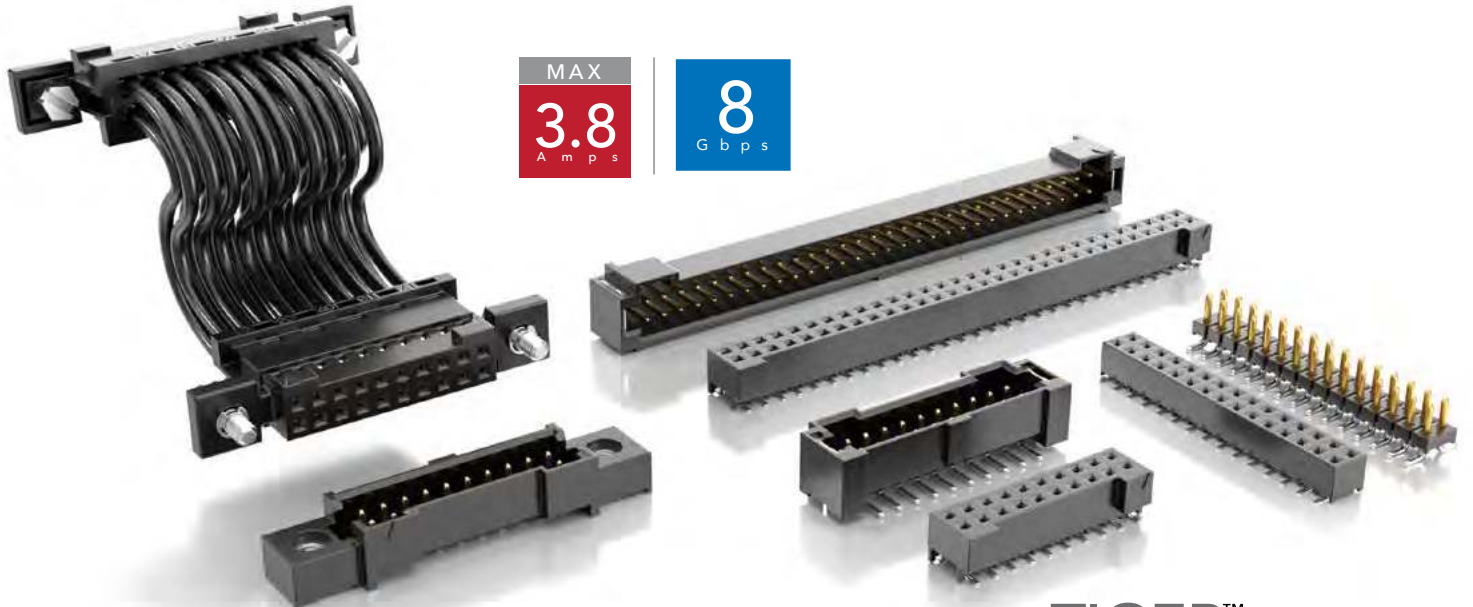

MAX
3.8
A m p s

8
G b p s

FEATURES & BENEFITS

- Rugged Tiger Eye™ contact system for high reliability
- Wide range of stack heights (SMM/TMM Series)
- Right-angle mating headers available
- Optional metal latching, screw downs, weld tabs and locking clips
- Surface mount or through-hole
- Discrete wire assemblies available in 24-30 AWG PVC or *Teflon™ Fluoropolymer (See page 240). Contact asp@samtec.com for custom solutions
- Severe Environment Testing qualified (S2M/T2M); aligns with MIL-DTL-55302. Visit samtec.com/set

*Teflon™ is a trademark of The Chemours Company FC, LLC used under license by Samtec.



Optional strain relief and variety of wiring options



Components (ISD2/CC81) & tooling available: samtec.com/tooling

KEY SPECIFICATIONS (S2M/T2M)

STACK HEIGHTS	INSULATOR MATERIAL	CONTACT MATERIAL	PLATING	OPERATING TEMP RANGE	CURRENT RATING	MAX. CYCLES	VOLTAGE RATING	LEAD-FREE SOLDERABLE
6 & 7 mm	Black LCP	BeCu (S2M) Phosphor Bronze (T2M)	Au or Sn over 50 μ" (1.27 μm) Ni	-55 °C to +125 °C	3.8 A (T2M) 2.6 A (S2M) (2 pins powered)	100 with 10 μ" (0.25 μm) Au	350 VAC	Yes

(2.00 mm) .0787" PITCH • HIGH-RELIABILITY CABLE INTERCONNECTS

SERIES	1	NO. OF POSITIONS	LEAD STYLE	PLATING OPTION	D	OPTIONS	PACKAGING
S2M Socket		05, 07, 10, 15, 20, 25, 30 (Per Row)	-01 = Through-hole -02 = Surface Mount	-F = Gold flash on contact, Matte Tin on tail -L = 10 μ" (0.25 μm) Gold on contact, Matte Tin on tail		-K = (5.50 mm) .217" DIA Polyimide film Pick & Place Pad (-02 only) -LC = Locking Clip (Manual placement required) (-02 only) -DS = Screw Down (N/A with -LC) (mates with -T2M-DS)	Leave blank for tube packaging -TR = Tape & Reel (-02 only) -FR = Full Reel Tape & Reel (must order max. quantity per reel; contact Samtec for quantity breaks) (-02 only)

S2M
Board Mates:
T2M
Cable Mates:
T2SD



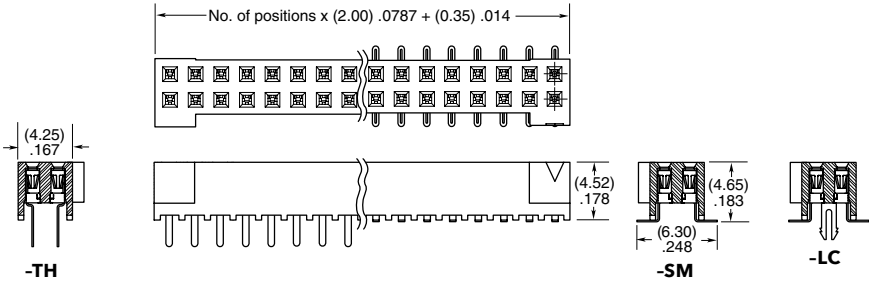

View complete specifications at: samtec.com?S2M

SERIES	1	NO. OF POSITIONS	01	PLATING OPTION	D	TAIL OPTION	OTHER OPTIONS	PACKAGING
T2M Header		05, 07, 10, 15, 20, 25, 30 (Per Row)		-L = 10 μ" (0.25 μm) Gold on contact, Matte Tin on tail		-TH = Through-hole -RA = Right-angle -SM = Surface Mount	-WT = Weld Tab (S2SD & S2SDT, -SR/-DR required mate) -DS = Screw Down (N/A with -RA) (mates with -S2M-DS, S2SD/S2SDT -SS/-DS option) -K = (7.50 mm) .295" DIA Polyimide film Pick & Place Pad (-SM only)	Leave blank for tube packaging -TR = Tape & Reel (-SM only) -FR = Full Reel Tape & Reel (must order max. quantity per reel; contact Samtec for quantity breaks) (-SM only)

T2M
Board Mates:
S2M
Cable Mates:
S2SD, S2SDT



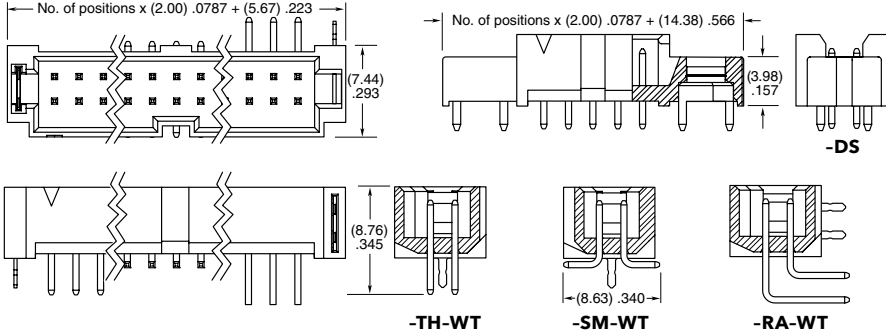

View complete specifications at: samtec.com?T2M

MATED HEIGHT

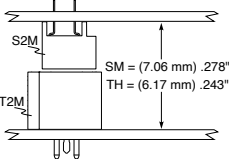

SM = (7.06 mm) .278"
TH = (6.17 mm) .243"

Notes:
Severe Environment Testing qualified; aligns with MIL-DTL-55302. Visit samtec.com/set

Some lengths, styles and options are non-standard, non-returnable.

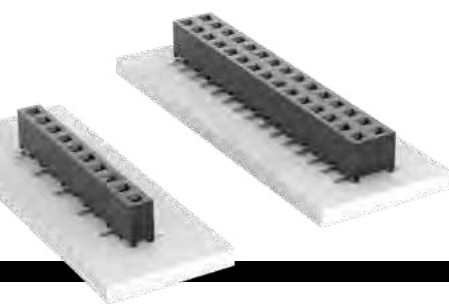

(2.00 mm) .0787" PITCH • TIGER EYE™ SOCKET

SMM	1	NO. PINS PER ROW	02	PLATING OPTION	ROW OPTION	OTHER OPTIONS
		02 thru 40		<p>-F = Gold flash on contact, Matte Tin on tail</p> <p>-L = 10 μ" (0.25 μm) Gold on contact, Matte Tin on tail</p> <p>-S = 30 μ" (0.76 μm) Gold on contact, Matte Tin on tail</p>	<p>-S = Single Row</p> <p>-D = Double Row</p>	<p>-"XX" = Polarized Position</p> <p>-K = (5.50 mm) .217" DIA Polyimide Film Pick & Place Pad (2 positions minimum, -02 thru -05 requires -TR)</p> <p>-P = Plastic Pick & Place Pad (-02 thru -05 requires -TR)</p> <p>-TR = Tape & Reel Packaging (27 positions maximum)</p> <p>-FR = Full Reel Tape & Reel (must order maximum quantity per reel; contact Samtec for quantity breaks) (27 positions maximum)</p>

SMM
Board Mates:
 TMM, TMMH, MTMM, MMT, LTMM, TW, PTT, ZLTMM
Cable Mates:
 TCMD

SPECIFICATIONS

Insulator Material:
 Black Liquid Crystal Polymer
Contact Material:
 BeCu
Plating: Sn or Au over
 50 μ" (1.27 μm) Ni
Current Rating (TMM/SMM):
 3.2 A per pin
 (2 pins powered)
Voltage Rating:
 350 VAC
Operating Temp Range:
 -55 °C to +125 °C
Insertion Depth:
 (3.05 mm) .120" to
 (3.25 mm) .128"
Max Cycles:
 100 with 10 μ" (0.25 μm) Au

PROCESSING

Lead-Free Solderable:
 Yes
SMT Lead Coplanarity:
 (0.10 mm) .004" max

ALSO AVAILABLE
 MOQ Required

Locking Clip
 (Manual placement required)
 Other platings

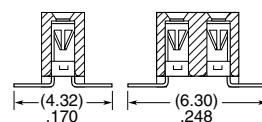
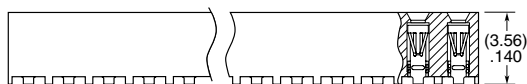
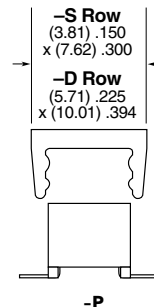
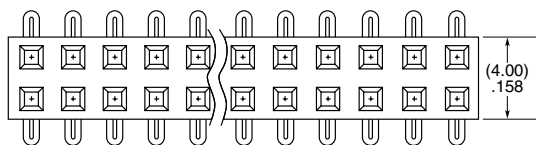
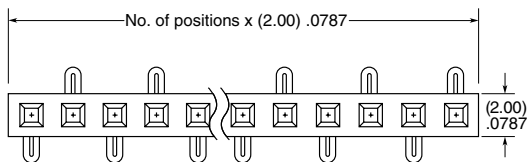

Note:
 Some lengths, styles and options are non-standard, non-returnable.

View complete specifications at: samtec.com?SMM

DISCRETE WIRE SYSTEMS

MICRO PITCH • HIGH-CYCLE CONTACTS • ISOLATED POWER • COMPONENTS & TOOLING



232-237

1.00 mm PITCH MICRO MATE™ SYSTEMS

Socket Cable Assemblies/Components (T1M, S1SS(T), S1SD(T), ISS1, ISD1, CC09)	232-235
Single Row Terminal Cable Assemblies/Components (T1SS(T), T1PS(T), IST1, ISP1, TC37)	236
Double Row Terminal Cable Assemblies/Components (T1SD(T), T1PD(T), IDT1, IDP1, TC37)	237

238-242

TIGER EYE™ SYSTEMS

1.27 mm Pitch Socket Cable Assembly/Components (SFSS(T), SFSD(T), ISDF, CC03)	238-239
2.00 mm Pitch Socket Cable Assembly/Components (S2SD(T), ISD2, CC81)	240
0.80 mm Pitch Socket Cable Assembly/Components (SESST, ISDE, CC396, TEM)	241-242

243-245

RUGGED POWER SYSTEMS

Power Mate® Cables & Components (PMSS(T), PMSD(T), IPBD, CC69)	243
Mini Mate® Cable System (MMSD(T) MMSS(T), IPD1, CC79, IPL1)	244-245

246-248

FLEX POWER SYSTEMS

PowerStrip™/30 Cables & Components (MPSS, IMS5, CC46)	246
PowerStrip™/30 Signal/Power Combo Cables & Components (MPCC, IMSC5, CC46, CC81)	247
PowerStrip™/40 Cables & Components (PESS, IPS6, CC10)	248

MICROMATE™

RUGGED MICRO CABLE SYSTEMS

(1.00 mm) .0394" PITCH

MAX
3.3
A m p s



FEATURES & BENEFITS

- Cable-to-cable, panel-to-board and cable-to-board applications
- Extremely small form factors
- 28 and 30 AWG wire options in PVC or Teflon™ Fluoropolymer
- Rugged positive latching for increased retention
- Socket or terminal, single or double row assemblies
- Vertical and right-angle mating headers

Teflon™ is a trademark of The Chemours Company FC, LLC used under license by Samtec.

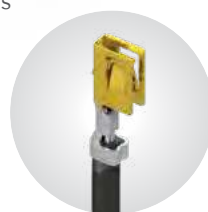

Dual leaf contact system for a reliable connection

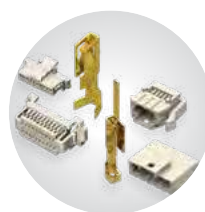

Components and tooling available:
samtec.com/tooling

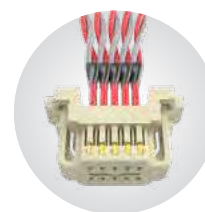

Custom solutions available contact:
asp@samtec.com

KEY SPECIFICATIONS (S1SX(T)/T1M, T1SX(T) & T1PX(T))

PITCH	INSULATOR MATERIAL	CONTACT MATERIAL	PLATING	OPERATING TEMP RANGE	CURRENT RATING	VOLTAGE RATING
1.00 mm	Black LCP (S1SS(T) without latch) Natural LCP (T1M) Natural Nylon (S1SS(T) with Latch, S1SD(T), T1XD(T)) Nylon, Light Green (T1XS(T))	Phosphor Bronze	Au or Sn over 50 μ" (1.27 μm) Ni	-10 °C to +85 °C (PVC) -40 °C to +125 °C (Teflon™ Fluoropolymer)	3.3 A per pin (1 pin powered) (Max.)	250 VAC/ 353 VDC

(1.00 mm) .0394" PITCH • DISCRETE WIRE TERMINAL STRIP

SERIES	NO. OF POSITIONS	PLATING OPTION	ROW OPTION	LATCH	OPTIONS	"X"R
T1M	-02, -03, -05, -07, -10, -15, -20	-F = 3 μ" (0.07 μm) Gold on contact, Matte Tin on tail	-SH = Single Row Horizontal -SV = Single Row Vertical	(Required in callout) -L = Positive Latch	-K = (4.00 mm) .157" DIA Polyimide Film Pick & Place Pad (-SH only) -P = Pick & Place Pad (-SV only)	(Leave blank for Tape & Reel) -FR = Full Reel Tape & Reel (must order max. quantity per reel; contact Samtec for quantity breaks)

T1M-SH/SV
Cable Mates:
S1SS(T), S1SD(T)

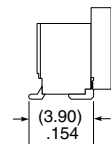
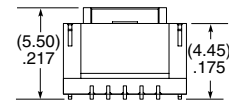
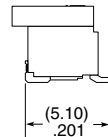
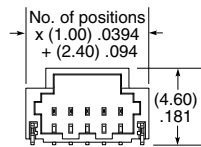
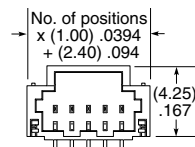
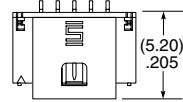
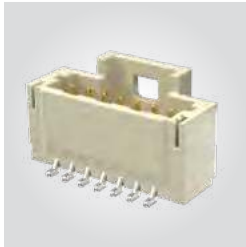

SPECIFICATIONS

Insulator Material:
Natural LCP
Terminal Material:
Phosphor Bronze
Plating:
Sn or Au over
50 μ" (1.27 μm) Ni
Operating Temp Range:
-55 °C to +125 °C
(Component only)
Voltage Rating:
250 VAC/353 VDC

View complete specifications at: samtec.com?T1M

SERIES	NO. OF POSITIONS	PLATING OPTION	ROW OPTION	OPTION	"X"R
T1M	-02, -03, -04, -05, -10, -15, -20 (Per Row)	-GF = 3 μ" (0.07 μm) Gold contact and tail	-DH = Double Row Horizontal -DV = Double Row Vertical	-K = (4.00 mm) .157" DIA Polyimide Film Pick & Place Pad (-DV only)	(Leave blank for Tape & Reel) -FR = Full Reel Tape & Reel (must order max. quantity per reel; contact Samtec for quantity breaks)

T1M-DH/DV
Cable Mates:
S1SS(T), S1SD(T)

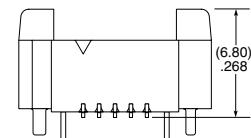
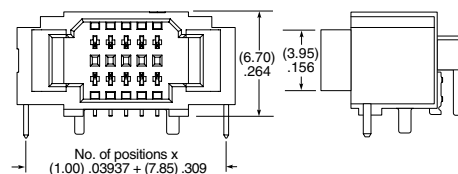
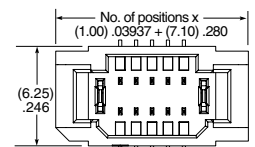
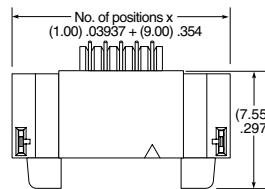
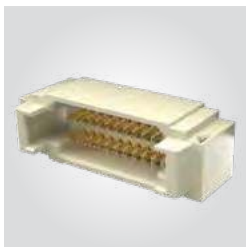

SPECIFICATIONS

Insulator Material:
Natural LCP
Terminal Material:
Phosphor Bronze
Plating: Sn or Au over
50 μ" (1.27 μm) Ni
Operating Temp Range:
-55 °C to +125 °C
(Component only)
Voltage Rating:
250 VAC/353 VDC

View complete specifications at: samtec.com?T1M

Note:
Some lengths, styles and options
are non-standard, non-returnable.

(1.00 mm) .0394" PITCH • SINGLE ROW DISCRETE WIRE SOCKET



SERIES	PINS PER ROW	WIRE GAUGE	PLATING OPTION	ASSEMBLED LENGTH	OPTION
S1SS = Single Row PVC Cable	-02, -03, -05, -07, -10 -15, -20 (Standard sizes)	-28 = 28 AWG -28C = 28 AWG Color Coded Cable (S1SS only)	-GF = 3 μ" (0.07 μm) Gold on contact and tail	-"XX.XX" = Assembled Length in Inches (45.72 mm) 01.80" min.	(Required Callout) -L = Single Ended With Latch -L1 = Double Ended Latch down, straight (Pin 1 to Pin 1) -L3 = Double Ended Latch up, straight (Pin 1 to Pin N) -S = Single Ended No Latch -D-NUS = Double Ended No Latch, "N" up, straight -D-NDS = Double Ended No Latch, "N" down, straight

S1SS(T)

Board Mates:

T1M

Cable Mates:

T1SS(T), T1PS(T)

SPECIFICATIONS

Insulator Material:

Nylon, White (with latch)

Black, LCP (without latch)

Contact Material:

Phosphor Bronze

Plating:

Au over 50 μ" (1.27 μm) Ni

Operating Temp Range (S1SS(T)/T1M):

-10 °C to +85 °C (PVC)

-40 °C to +125 °C (*Teflon™ Fluoropolymer)

Current Rating (28 AWG):

2.7 A per pin (1 pin powered)

Voltage Rating:

250 VAC/353 VDC

Wire: 28 or 30 AWG

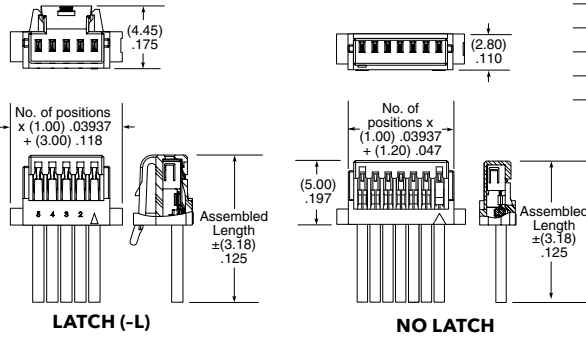

S1SS CABLE COLOR CODING

PIN	COLOR
1	BROWN
2	RED
3	ORANGE
4	YELLOW
5	GREEN
6	BLUE
7	VIOLET
8	GRAY
9	WHITE
10	BLACK
ETC	REPEAT

*Teflon™ is a trademark of The Chemours Company FC, LLC used under license by Samtec.

Note: Teflon™ Fluoropolymer cable is intended for crimp only. Contact Samtec for solderable cable applications.

View complete specifications at: samtec.com?S1SS & samtec.com?S1ST

SERIES	NO. OF POSITIONS	LATCH	SERIES	01	PLATING
ISS1 = Single Row Body	-02, -03, -05, -07, -10, -15, -20	(Leave blank for no latch) -L = Positive Latch	CC09R = Contact, Full Reel (25,000 Parts per Reel)		-GF = 3 μ" (0.07 μm) Gold contact and tail

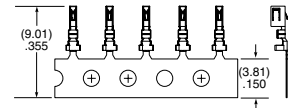
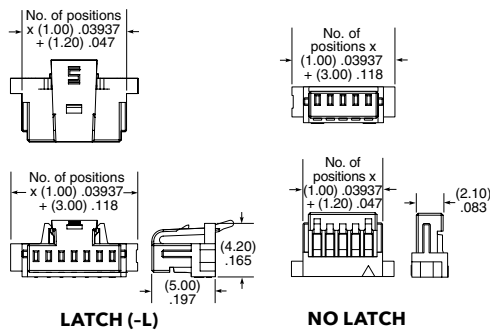

TOOLING

Hand Tool: CAT-HT-309-2830-12

Clamp for mounting hand tool: CAT-HT-MNT-01

Mini Applicator: CAT-MC-309-2830-XX-01

Note:

Some lengths, styles and options are non-standard, non-returnable.

View complete specifications at: samtec.com?ISS1, samtec.com?CC09R & samtec.com?CC09M

(1.00 mm) .0394" PITCH • DOUBLE ROW DISCRETE WIRE SOCKET

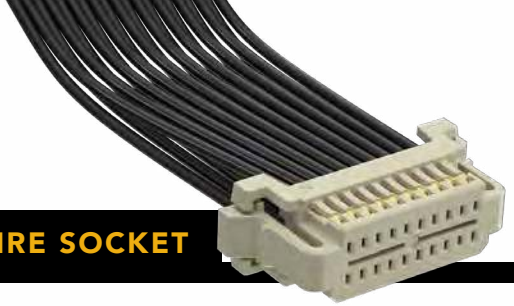

SERIES	PINS PER ROW	WIRE GAUGE	PLATING OPTION	ASSEMBLED LENGTH	WIRING OPTION
S1SD = Double Row PVC Cable S1SDT = Double Row Blue *Teflon™ Fluoropolymer Cable	-02, -03 -04, -05, -10, -15, -20 (Standard sizes)	-28 = 28 AWG -30 = 30 AWG	-GF = 3 μ" (0.07 μm) Gold on contact and tail	-"XX.XX" = Assembled Length in Inches (45.72 mm) 01.80" min.	Double Ended Assemblies -L1 = Pin 1 to Pin 1 -L2 = Pin 1 to Pin 2 -L3 = Pin 1 to Pin N -L4 = Pin 1 to Pin N-1 Single Ended Assembly -L = Latching

S1SD(T)
Board Mates:
T1M
Cable Mates:
T1SD(T), T1PD(T)

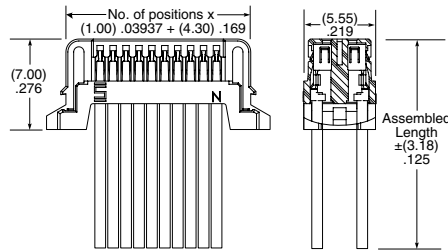
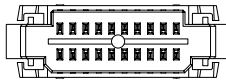



SPECIFICATIONS

Insulator Material:
White Nylon
Contact Material:
Phosphor Bronze
Plating:
Au over 50 μ" (1.27 μm) Ni
Operating Temp Range (S1SD(T)/T1M):
-10 °C to +85 °C (PVC)
-40 °C to +125 °C (*Teflon™ Fluoropolymer)
Current Rating (28 AWG):
2.3 A per pin
(2 pins powered)
Voltage Rating:
250 VAC/353 VDC
Wire:
28 or 30 AWG

*Teflon™ is a trademark of The Chemours Company FC, LLC used under license by Samtec.

Note:
Teflon™ Fluoropolymer cable is intended for crimp only. Contact Samtec for solderable cable applications.

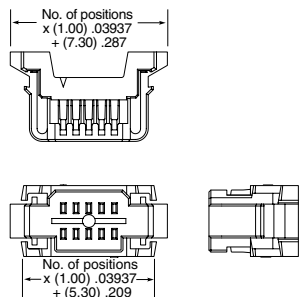
View complete specifications at: samtec.com?S1SD & samtec.com?S1SDT

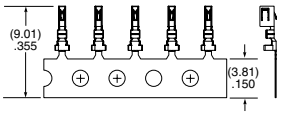
SERIES	NO. OF POSITIONS	SERIES	01	PLATING
ISD1 = Double Row Body	-02, -03, -04, -05, -10, -15, -20 (Per Row)	CC09R = Contact, Full Reel (25,000 Parts per Reel) CC09M = Contact, Mini Reel (5,000 Parts per Reel)		-GF = 3 μ" (0.07 μm) Gold contact and tail
				

TOOLING

Hand Tool: CAT-HT-309-2830-12

Clamp for mounting hand tool: CAT-HT-MNT-01

Mini Applicator: CAT-MC-309-2830-XX-01

Note:
Some lengths, styles and options are non-standard, non-returnable.

View complete specifications at: samtec.com?ISD1, samtec.com?CC09R & samtec.com?CC09M



(1.00 mm) .0394" • SINGLE ROW DISCRETE WIRE TERMINAL

SERIES	NO. OF POSITIONS	WIRE GAUGE	PLATING OPTION	ASSEMBLED LENGTH	PANEL OPTION	PINOUT
T1SS = Single Row Non-Panel Mount PVC Cable T1PS = Single Row Panel Mount PVC Cable T1SST = Single Row Non-Panel Mount Blue *Teflon™ Fluoropolymer Cable T1PST = Double Row Panel Mount Blue *Teflon™ Fluoropolymer Cable T1SS(T), T1PS(T) Cable Mates: S1SS, S1SST	-02 positions not available with T1PS or T1PST) -02 thru -10 (Per Row)	-28 = 28 AWG -28C = 28 AWG Color Coded Cable (T1SS & T1PS only) -30 = 30 AWG -30C = 30 AWG Color Coded Cable (T1SS & T1PS only)	-GF = 3 μ" (0.07 μm) Gold on contact and tail	-"XX.X" = Assembled Length in Inches (45.7 mm) 01.8" min.	(Leave blank for non-panel mount) -A = Fits .033" (0.84 mm), .062" (1.57 mm) and .090" (2.29 mm) Thick Panels	(Leave blank for single ended assembly) -D1 = Double Ended down (Not available with T1PS or T1PST) -D3 = Double Ended up (Not available with T1PS or T1PST) -T1 = Transfer to socket up -T3 = Transfer to socket up

-28C, -30C CABLE COLOR CODING

PIN	COLOR
1	BROWN
2	RED
3	ORANGE
4	YELLOW
5	GREEN
6	BLUE
7	VIOLET
8	GRAY
9	WHITE
10	BLACK
ETC	REPEAT

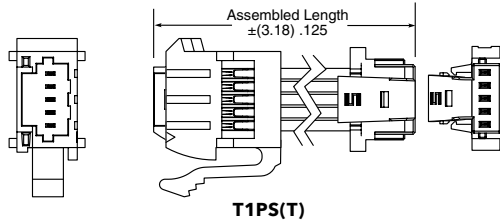
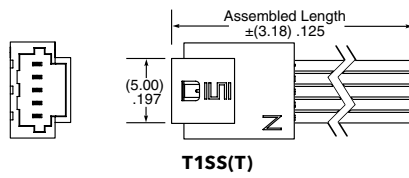

SPECIFICATIONS

Insulator Material: Nylon, Light Green
Contact Material: Phosphor Bronze
Plating: Au over 50 μ" (1.27 μm) Ni
Operating Temp Range: -10 °C to +80 °C (PVC) -40 °C to +125 °C (*Teflon™ Fluoropolymer)
Wire: 28 or 30 AWG

*Teflon™ is a trademark of The Chemours Company FC, LLC used under license by Samtec.

Note: Teflon™ Fluoropolymer cable is intended for crimp only. Contact Samtec for solderable cable applications.

View complete specifications at: samtec.com?T1SS, samtec.com?T1SST, samtec.com?T1PS & samtec.com?T1PST

SERIES	NO. OF POSITIONS	PANEL THICKNESS	SERIES	01	PLATING
IST1 = Single Row Body ISP1 = Single Row Panel Mount Body	-02 thru -10 (IST1 Body) -03 thru -10 (ISP1 Body)	(Leave blank for IST1) -A = Fits 0.84 mm, 1.57 mm & 2.29 mm Thick Panels	TC37R = Contact, Full Reel (25,000 Parts per Reel) TC37M = Contact, Mini Reel (1,000 - 5,000 Parts per Reel)		-GF = 3 μ" (0.07 μm) Gold contact and tail

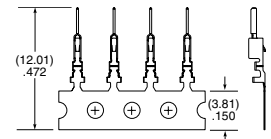
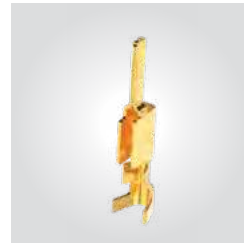
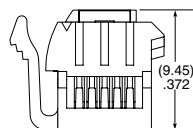
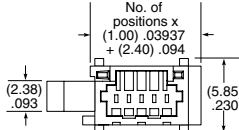
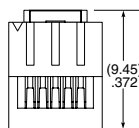
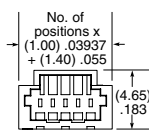

TOOLING

Hand Tool: CAT-HT-1137-2830-12

Mini Applicator: CAT-MC-309-2830-XX-01

Note: Some lengths, styles and options are non-standard, non-returnable.

View complete specifications at: samtec.com?IST1, samtec.com?ISP1, samtec.com?TC37R & samtec.com?TC37M

(1.00 mm) .0394" PITCH • DOUBLE ROW DISCRETE WIRE TERMINAL



SERIES	NO. OF POSITIONS	WIRE GAUGE	PLATING OPTION	ASSEMBLED LENGTH	PANEL OPTION	PINOUT																										
T1SD = Double Row Non-Panel Mount PVC Cable T1PD = Double Row Panel Mount PVC Cable T1SDT = Double Row Non-Panel Mount Blue *Teflon™ Fluoropolymer Cable T1PDT = Double Row Panel Mount Blue *Teflon™ Fluoropolymer Cable	-02 thru -10 (Per Row)	-28 = 28 AWG -28C = 28 AWG Color Coded Cable (T1SD & T1PD only) -30 = 30 AWG -30C = 30 AWG Color Coded Cable (T1SD & T1PD only)	-GF = 3 μ" (0.07 μm) Gold on contact and tail <table border="1"> <thead> <tr> <th colspan="2">-28C, -30C CABLE COLOR CODING</th> </tr> <tr> <th>PIN</th> <th>COLOR</th> </tr> </thead> <tbody> <tr><td>1</td><td>BROWN</td></tr> <tr><td>2</td><td>RED</td></tr> <tr><td>3</td><td>ORANGE</td></tr> <tr><td>4</td><td>YELLOW</td></tr> <tr><td>5</td><td>GREEN</td></tr> <tr><td>6</td><td>BLUE</td></tr> <tr><td>7</td><td>VIOLET</td></tr> <tr><td>8</td><td>GRAY</td></tr> <tr><td>9</td><td>WHITE</td></tr> <tr><td>10</td><td>BLACK</td></tr> <tr><td>ETC</td><td>REPEAT</td></tr> </tbody> </table>	-28C, -30C CABLE COLOR CODING		PIN	COLOR	1	BROWN	2	RED	3	ORANGE	4	YELLOW	5	GREEN	6	BLUE	7	VIOLET	8	GRAY	9	WHITE	10	BLACK	ETC	REPEAT	-"XX.X" = Assembled Length in Inches (45.7 mm) 01.8" min.	(Leave blank for non-panel mount) -A = Fits .033" (0.84 mm), .062" (1.57 mm) and .090" (2.29 mm) Thick Panels	(Leave blank for single ended assembly) -D1 = Double Ended down (Not available with T1PD or T1PDT) -D3 = Double Ended up (Not available with T1PD or T1PDT) -T1 = Transfer to socket down -T3 = Transfer to socket up
-28C, -30C CABLE COLOR CODING																																
PIN	COLOR																															
1	BROWN																															
2	RED																															
3	ORANGE																															
4	YELLOW																															
5	GREEN																															
6	BLUE																															
7	VIOLET																															
8	GRAY																															
9	WHITE																															
10	BLACK																															
ETC	REPEAT																															

T1SD(T), T1PD(T)
Cable Mates:
S1SD, S1SDT

SPECIFICATIONS

Insulator Material: Nylon, White
Contact Material: Phosphor Bronze
Plating: Au over 50 μ" (1.27 μm) Ni
Operating Temp Range: -10 °C to +80 °C (PVC)
 -40 °C to +125 °C (*Teflon™ Fluoropolymer)
Wire: 28 or 30 AWG

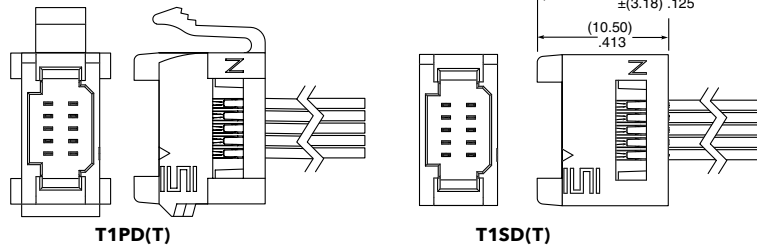

*Teflon™ is a trademark of The Chemours Company FC, LLC used under license by Samtec.

Note: Teflon™ Fluoropolymer cable is intended for crimp only. Contact Samtec for solderable cable applications.

View complete specifications at: samtec.com?T1SD, samtec.com?T1SDT, samtec.com?T1PD & samtec.com?T1PDT

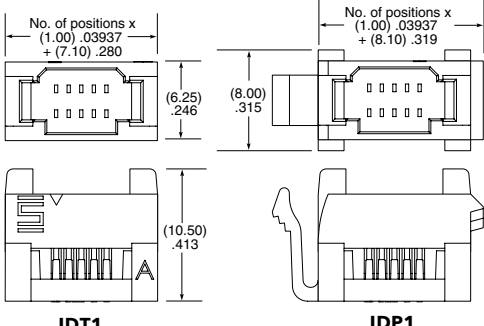
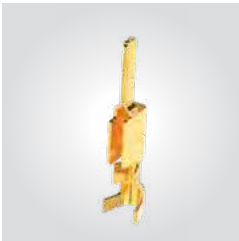
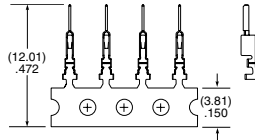
SERIES	NO. OF POSITIONS	PANEL THICKNESS	SERIES	01	PLATING
IDT1 = Double Row Body IDP1 = Double Row Panel Mount Body	-02 thru -10 (per row)	(Leave blank for IDT1) -A = Fits 0.84 mm, 1.57 mm & 2.29 mm Thick Panels	TC37R = Contact, Full Reel (25,000 Parts per Reel) TC37M = Contact, Mini Reel (1,000 - 5,000 Parts per Reel)		-GF = 3 μ" (0.07 μm) Gold contact and tail
					

Note: Some lengths, styles and options are non-standard, non-returnable.

TOOLING

Hand Tool: CAT-HT-1137-2830-12

Mini Applicator: CAT-MC-309-2830-XX-01

View complete specifications at: samtec.com?IDT1, samtec.com?IDP1, samtec.com?TC37R & samtec.com?TC37M

(1.27 mm) .050" PITCH • DISCRETE WIRE ASSEMBLY/COMPONENTS

SERIES	POSITIONS PER ROW	WIRE GAUGE	PLATING OPTION	ASSEMBLED LENGTH	END OPTION	END 2 OPTION
--------	-------------------	------------	----------------	------------------	------------	--------------

SFSS
= Single Row
PVC Cable

SFSST
= Single Row
Blue *Teflon™
Fluoropolymer
Cable

-03, -04, -05,
-07, -10, -15,
-20, -25, -40, -50
(Standard sizes)

-28
= 28 AWG

-28C
= Color
Coded Cable
(SFSS only)

-30
= 30 AWG

-G
= 10 μm
(0.25 μm)
Gold on
contact,
Gold Flash
on balance

-"XX.XX"
= Assembled
Length in Inches
(76.20 mm)
03.00" min. for
-S end option
(82.60 mm)
03.25" min. for
-D end option

-S
= Single Ended

-D
= Double Ended

-SR
= Single Ended
Retention Latch
(TFM-WT option
required for mating)

-DR
= Double Ended
Retention Latch
(TFM-WT option
required for mating)

Requires
-D or -DR
(End 1 Notch Up)

-NUS
= Notch up,
straight
(Pin 1 to Pin N)

-NDS
= Notch down,
straight
(Pin 1 to Pin 1)

-28C CABLE COLOR CODING	
PIN	COLOR
1	BROWN
2	RED
3	ORANGE
4	YELLOW
5	GREEN
6	VIOLET
7	GRAY
8	WHITE
9	BLACK
10	BLUE
ETC	REPEAT

SFSS(T)

Board Mates:

TFM, TFC

(-SR & -DR requires
-WT option)

SPECIFICATIONS

Insulator Material:

Black LCP

Contact Material:

BeCu

Plating:

Au over 50 μm (1.27 μm) Ni

Current Rating:

2.9 A per pin (2 pins powered)

Operating Temp Range:

-10 °C to +80 °C (PVC)

-40 °C to +125 °C

(*Teflon™ Fluoropolymer)

Voltage Rating:

275 VAC (PVC)

235 VAC

(*Teflon™ Fluoropolymer)

Wire:

28 or 30 AWG

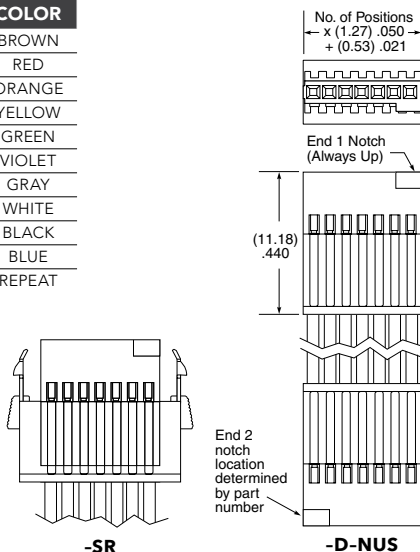

-SR

-D-NUS

SFSS OR SFSST

*Teflon™ is a trademark of The Chemours Company FC, LLC used under license by Samtec.

Notes:
Teflon™ Fluoropolymer cable is intended for crimp only. Contact Samtec for solderable cable applications.

For wiring option information refer to drawings on web.

View complete specifications at: samtec.com?SFSS & samtec.com?SFSST

ISDF	POSITIONS PER ROW	ROW OPTION	OPTION	SERIES	WIRE GAUGE	01	PLATING
------	-------------------	------------	--------	--------	------------	----	---------

-03, -04, -05,
-07, -10, -15,
-20, -25, -40, -50
(Standard sizes)

-S
= Single
Row

-M
= Metal
Retention
Latch

CC03R
= Contact, Full Reel
(35,000 Parts per Reel)

-2830
= 28 to 30
AWG

-GF
= Gold flash
contact

CC03M
= Contact, Mini Reel
(1,000 - 5,000 Parts
per Reel)

-G
= 10 μm (0.25 μm)
Gold on contact

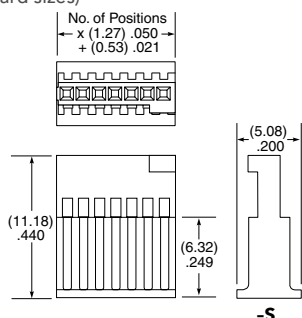

-S

-M

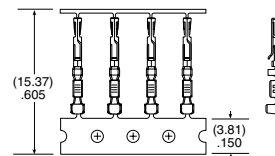

TOOLING

Hand Tool: CAT-HT-203-2830-12

Mini Applicator: CAT-MC-203-2830-XX-01

Clamp for mounting hand tool: CAT-HT-MNT-01

Extraction Tool: CAT-EX-169-01

Note:
Some lengths, styles and
options are non-standard,
non-returnable.

View complete specifications at: samtec.com?ISDF, samtec.com?CC03R & samtec.com?CC03M

(1.27 mm) .050" PITCH • DISCRETE WIRE ASSEMBLY/COMPONENTS

SERIES	POSITIONS PER ROW	WIRE GAUGE	PLATING OPTION	ASSEMBLED LENGTH	END OPTION	END 2 OPTION
SFSD = Double Row PVC Cable SFSDT = Double Row Blue *Teflon™ Fluoropolymer Cable	-03, -04, -05, -07, -10, -15, -20, -25, -40, -50 (Standard sizes)	-28 = 28 AWG -28C = Color Coded Cable (SFSD only) -30 = 30 AWG	-G = 10 μ" (0.25 μm) Gold on contact, Gold Flash on balance	-"XX.XX" = Assembled Length in Inches (76.20 mm) 03.00" min. for -S end option (82.60 mm) 03.25" min. for -D end option	-S = Single Ended -D = Double Ended For -(X) specify "S" for single ended and "D" for double ended. -(X)R = Retention Latch (TFM-WT option required for mating) -(X)S = Screw Down (Not available in -03, -04 & -50 positions) (Mates with TFM-DS option)	Requires -D, -DS, -DR (End 1 Notch Up) -NUS = Notch up, straight (Pin 1 to Pin N-1) -NDS = Notch down, straight (Pin 1 to Pin 2) -NUX = Notch up, crossed (Pin 1 to Pin N) -NDX = Notch down, crossed (Pin 1 to Pin 1)

SFSD(T) Board Mates: TFM, TFML, TFC (-SR & -DR requires -WT option)

SPECIFICATIONS

Insulator Material: Black LCP
Contact Material: BeCu
Plating: Au over 50 μ" (1.27 μm) Ni
Current Rating: 2.9 A per pin (2 pins powered)
Operating Temp Range: -10 °C to +80 °C (PVC) -40 °C to +125 °C (*Teflon™ Fluoropolymer)
Voltage Rating: 280 VAC (PVC) 313 VAC (*Teflon™ Fluoropolymer)
Wire: 28 or 30 AWG

PIN	COLOR
1	BROWN
2	RED
3	ORANGE
4	YELLOW
5	GREEN
6	VIOLET
7	GRAY
8	WHITE
9	BLACK
10	BLUE
ETC	REPEAT

End 1 Notch (Always Up)
 End 2 notch location determined by part number

*Teflon™ is a trademark of The Chemours Company FC, LLC used under license by Samtec.

Notes: Teflon™ Fluoropolymer cable is intended for crimp only. Contact Samtec for solderable cable applications.

For wiring option information refer to drawings on web.

View complete specifications at: samtec.com?SFSD & samtec.com?SFSDT

ISDF	POSITIONS PER ROW	ROW OPTION	OPTION	SERIES	WIRE GAUGE	01	PLATING
	-03, -04, -05, -07, -10, -15, -20, -25, -40, -50 (Standard sizes)	-D = Double Row	-M = Metal Retention Latch -S = Screw Down	CC03R = Contact, Full Reel (35,000 Parts per Reel) CC03M = Contact, Mini Reel (1,000 - 5,000 Parts per Reel)	-2830 = 28 to 30 AWG		-GF = Gold flash contact -G = 10 μ" (0.25 μm) Gold on contact

End 1 Notch (Always Up)
 End 2 notch location determined by part number

TOOLING

Hand Tool: CAT-HT-203-2830-12	Mini Applicator: CAT-MC-203-2830-XX-01
Clamp for mounting hand tool: CAT-HT-MNT-01	Extraction Tool: CAT-EX-169-01

Note: Some lengths, styles and options are non-standard, non-returnable.

View complete specifications at: samtec.com?ISDF, samtec.com?CC03R & samtec.com?CC03M

(2.00 mm) .0787" PITCH • CABLE ASSEMBLY/COMPONENTS



SERIES	PINS PER ROW	WIRE GAUGE	PLATING OPTION	ASSEMBLED LENGTH	END OPTIONS	END 2 OPTIONS
S2SD = Double Row PVC Cable	-05, -07, -10, -15, -20, -25, -30 (Standard sizes)	-24 -24C = Color Coded Cable (S2SD only)	-L = 10 μ" (0.25 μm) Gold on contact	-"XX.XX" = Wire Length in Inches (69.85 mm) 02.75" min.	-S = Single End -D = Double End Specify "S" for single ended and "D" for double ended. -(X)R = Retention Latch (-SR mates with T2M-WT) -(X)S = Screw Down (10 positions minimum) (mates with T2M-DS)	(Only available with -D, -DR & -DS) -NUS = Notch up, straight (Pin 1 to Pin N-1) -NDS = Notch down, straight (Pin 1 to Pin 2) -NUX = Notch up, crossed (Pin 1 to Pin N) -NDX = Notch down, crossed (Pin 1 to Pin 1)
S2SDT = Double Row Blue *Teflon™ Fluoropolymer Cable (24, 28, 30 AWG only)		-26 -28 -30				

S2SD(T)

Board Mates:

T2M

SPECIFICATIONS

Insulator Material: Black LCP
Contact Material: BeCu
Plating: Au over 50 μ" (1.27 μm) Ni
Wire: 24, 26, 28 or 30 AWG
Operating Temp Range: -10 °C to +105 °C (PVC) -40 °C to +125 °C (*Teflon™ Fluoropolymer)
Current Rating (S2SD-24/T2M): 3.8 A per pin (2 pins powered)
Voltage Rating: 250 VAC

-24C CABLE COLOR CODING

PIN	COLOR
1	BROWN
2	RED
3	ORANGE
4	YELLOW
5	GREEN
6	VIOLET
7	GRAY
8	WHITE
9	BLACK
10	BLUE
ETC	REPEAT

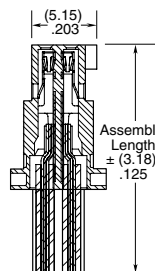
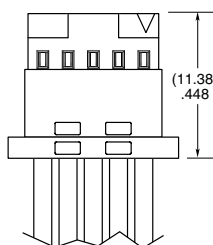
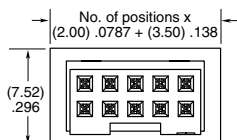

*Teflon™ is a trademark of The Chemours Company FC, LLC used under license by Samtec.

Notes: Teflon™ Fluoropolymer cable is intended for crimp only. Contact Samtec for solderable cable applications.

For wiring option information refer to drawings on web.

View complete specifications at: samtec.com?S2SD & samtec.com?S2SDT

ISD2	POSITIONS PER ROW	ROW OPTION	LATCH OPTION	SERIES	WIRE GAUGE	01	PLATING OPTION
	-05, -07, -10, -15, -20, -25, -30 (Standard sizes)	-D = Double Row	-M = Metal Retention Latch -S = Screw Down	CC81L = Contact, Loose CC81R = Contact, Full Reel (17,000 Parts per Reel)	-2426 = 24 to 26 AWG -2830 = 28 to 30 AWG		-L = 10 μ" (0.25 μm) Gold on contact

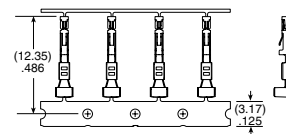
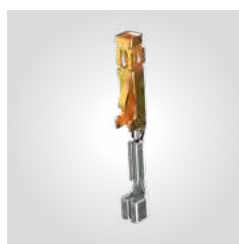
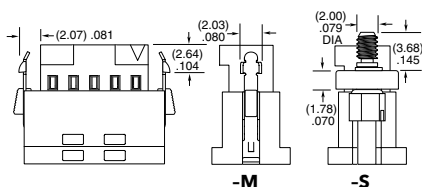

TOOLING

Hand Tool: CAT-HT-281-2430-13	Mini Applicator: CAT-MC-281-2426-XX-01 (24-26 AWG)
Extraction Tool: CAT-EX-169-01	Mini Applicator: CAT-MC-281-2830-XX-01 (28-30 AWG)

Note: Some lengths, styles and options are non-standard, non-returnable.

View complete specifications at: samtec.com?ISD2, samtec.com?CC81R & samtec.com?CC81L



(0.80 mm) .0315" PITCH • DISCRETE WIRE CABLE ASSEMBLY/COMPONENTS

SESDT	POSITIONS PER ROW	32	PLATING OPTION	ASSEMBLED LENGTH	OPTIONS
-------	-------------------	----	----------------	------------------	---------

= Double Row
Blue *Teflon™
Fluoropolymer Cable
(32 AWG)

-05, -10, -15, -20
(Standard sizes)

-G
= 10 μ" (0.25 μm)
Gold on contact area,
3 μ" (0.08 μm) Gold on tail

-"XX.X"
= Assembled
Length in Inches
(76.2 mm) 03.0" min.

Double Ended Assemblies

-L1
= Pin 1 to Pin 1

-L2
= Pin 1 to Pin 2

-L3
= Pin 1 to Pin N-1

-L4
= Pin 1 to Pin N

Single Ended Assembly

-L
= Latching

SESDT

Board Mates:

TEM-L1

SPECIFICATIONS

Insulator Material:

Natural Nylon

Contact Material:

BeCu

Plating:

Au over 50 μ" (1.27 μm) Ni

Wire:

Tinned Copper

Wire Insulation:

FEP

Operating Temp Range:

-55 °C to +125 °C

Current Rating:

1.9 A per pin

(2 pins powered)

Voltage Rating:

200 VAC/280 VDC

*Teflon™ is a trademark of The Chemours Company FC, LLC used under license by Samtec.

Note:

Teflon™ Fluoropolymer cable is intended for crimp only. Contact Samtec for solderable cable applications.

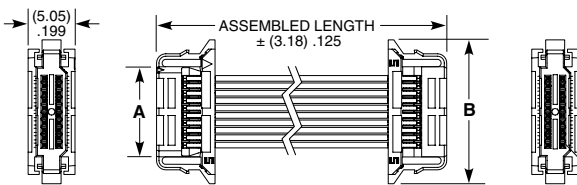

DOUBLE ENDED

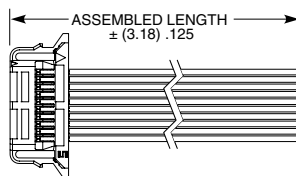

SINGLE ENDED

NO. OF POSITIONS	A	B
-05	(5.70) .224	(11.50) .453
-10	(9.70) .382	(15.50) .610
-15	(13.70) .539	(19.50) .768
-20	(17.70) .697	(23.50) .925

View complete specifications at: samtec.com?SESDT

ISDE	POSITIONS PER ROW	D	L	SERIES	WIRE GAUGE	PLATING	REEL OPTIONS
------	-------------------	---	---	--------	------------	---------	--------------

-05, -10, -15, -20
(Standard sizes)

-D
= Dual Row

-L
= Latch

CC396
= Contact

-3234
= 32 to 34 AWG

-G
= 10 μ" (0.25 μm)
Gold on contact area,
3 μ" (0.08 μm)
Gold on tail

-U
= Micro Reel
(4K Contacts)

-M
= Mini Reel
(15K Contacts)

-R
= Reel
(50K Contacts)

POSITIONS PER ROW	A	B
-05	(9.50) .374	(11.50) .453
-10	(13.50) .531	(15.50) .610
-15	(17.50) .689	(19.50) .768
-20	(21.50) .846	(23.50) .925

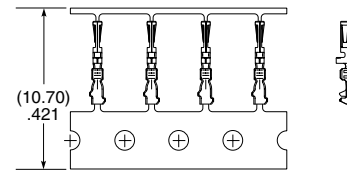
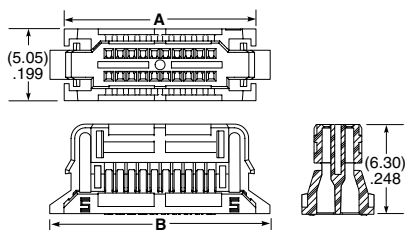

TOOLING

Hand Tool: CAT-HT-396-3232-12

Mini Applicator: CAT-MC-396-3232-XX-03

Note:

Some lengths, styles and options are non-standard, non-returnable

View complete specifications at: samtec.com?ISDE & samtec.com?CC396

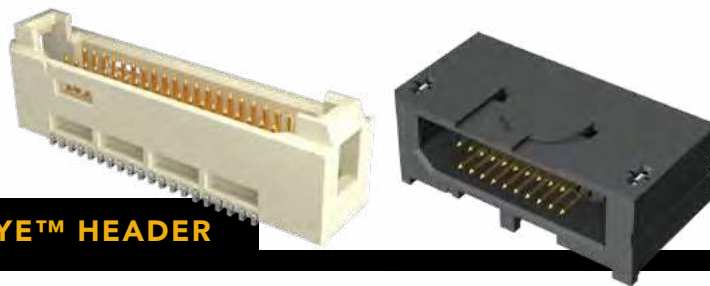

(0.80 mm) .0315" PITCH • MICRO TIGER EYE™ HEADER

TEM	1	NO. OF POSITIONS	02	DH1	PLATING OPTION	D	OPTION
		10, 15, 20, 25, 30, 35, 40, 45, 50 (Per Row) (Standard sizes)			-F = Gold Flash on contact, Matte Tin on tail		-A = Alignment Pin
					-L = 10 μ" (0.25 μm) Gold on contact, Matte Tin on tail		
					-S = 30 μ" (0.76 μm) Gold on contact, Matte Tin on tail		

TEM-DH
Board Mates:
SEM, SEML

SPECIFICATIONS

Insulator Material:
Black Liquid Crystal Polymer
Terminal Material:
Phosphor Bronze
Plating:
Au or Sn over
50 μ" (1.27 μm) Ni
Current Rating:
2.9 A per pin
(2 pins powered)
Voltage Rating:
235 VAC/330 VDC
Operating Temp Range:
-55 °C to +125 °C

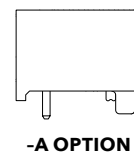
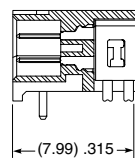
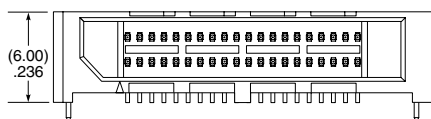
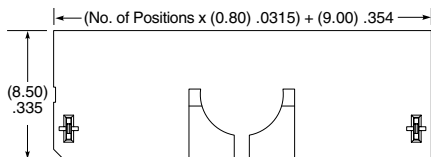

PROCESSING

Lead-Free Solderable:
Yes
SMT Lead Coplanarity:
(0.10 mm) .004" max.

View complete specifications at: samtec.com?TEM

TEM	1	POSITIONS PER ROW	02	03.0	PLATING OPTION	D	L1	OPTIONS
		05, 10, 15, 20 (Standard sizes)			-G = 10 μ" (0.25 μm) Gold on contact, Gold Flash on tail		-L1 = Latching	-K = (5.50 mm) .217" DIA. Polyimide film Pick & Place Pad
								-TR = Tape & Reel
								-FR = Full Reel Tape & Reel (must order max. quantity per reel; contact Samtec for quantity breaks)

TEM-L1
Cable Mates:
SESDT

SPECIFICATIONS

Insulator Material:
Natural Liquid Crystal Polymer
Terminal Material:
Phosphor Bronze
Plating:
Au over 50 μ" (1.27 μm) Ni
Current Rating:
1.9 A per pin (2 pins powered)
Voltage Rating:
235 VAC/330 VDC
Operating Temp Range:
-55 °C to +125 °C

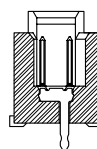
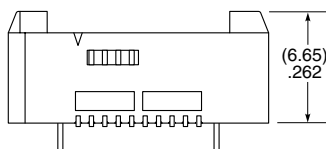
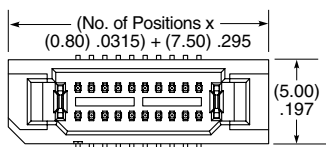

PROCESSING

Lead-Free Solderable:
Yes
SMT Lead Coplanarity:
(0.10 mm) .004" max.

Note:
Some lengths, styles and
options are non-standard,
non-returnable

View complete specifications at: samtec.com?TEM



SERIES	PINS PER ROW	WIRE GAUGE	K	ASSEMBLED LENGTH	END OPTION	LATCH OPTION
PMSD = Double Row PVC Cable	-02,	-16	-K = Keyed Polarization	-"XX.XX" = Wire length in inches (88.90 mm) 03.50" min.	-S = Single Ended	-LUS = Plastic Latch up, straight
PMSDT = Double Row Blue *Teflon™ Fluoropolymer Cable (24 AWG only)	-03, -04,	-18			-D = Double Ended (Latch Required)	-LDS = Plastic Latch down, straight
PMSS = Single Row PVC Cable	-05, -08,	-206 (20 AWG/ 600 volts)				-LUX* = Plastic Latch up, crossed
PMSST = Single Row Blue *Teflon™ Fluoropolymer Cable (24 AWG)	-10, -15* (Standard sizes) *Only available for double row	-22				-LDX* = Plastic Latch down, crossed
		-24				*(PMSD/PMSDT only)

PMSD, PMSDT, PMSS, PMSST
Board Mates:
IPBT

SPECIFICATIONS

Insulator Material: Valox 457
Contact Material: Phosphor Bronze
Plating: Sn over 50 μm (1.27 μm) Ni
Operating Temp Range: -10 °C to +105 °C (PVC)
 -40 °C to +105 °C (Teflon™ Fluoropolymer)

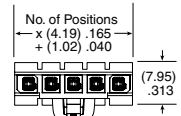

PMSD/PMSST

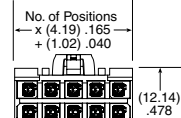

PMSS/PMSSST

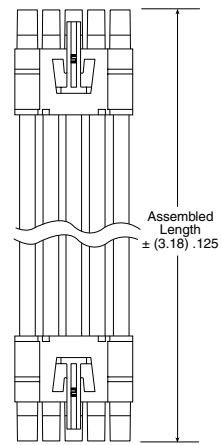

PMSD/IPBT		
WIRE GAUGE	CURRENT RATING (PER PIN)	VOLTAGE RATING
16 AWG	*10.3 A	424 VAC/600 VDC (PVC)
18 AWG	*8.8 A	
22 AWG	*5.7 A	300 VAC/424 VDC (PVC)
24 AWG	*5.2 A	424 VAC/600 VDC (PVC)
		300 VAC/424 VDC (PMSXT)

*2 PINS POWERED

*Teflon™ is a trademark of The Chemours Company FC, LLC used under license by Samtec.

Notes: Teflon™ Fluoropolymer cable is intended for crimp only. Contact Samtec for solderable cable applications.

For wiring option information refer to drawing on web.

View complete specifications at: samtec.com?PMSD, samtec.com?PMSDT, samtec.com?PMSS & samtec.com?PMSST

IPBD	POSITIONS PER ROW	ROW OPTION	K	SERIES	WIRE GAUGE	01	T	SP
	-02, -03, -04, -05, -08, -10, -15 (Standard sizes)	-S = Single Row -D = Double Row	-K = Keyed Polarization	CC69L = Contact, Loose CC69R = Contact, Full Reel (4,000 Parts per Reel)	-2024 = 20 to 24 AWG -1620 = 16 to 20 AWG		-T = Tin	



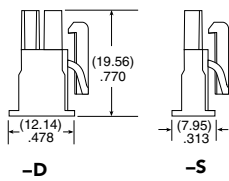

-D



-S



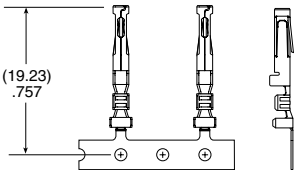

TOOLING

Hand Tool: CAT-HT-169-1620-13 (16-20 AWG) Hand Tool: CAT-HT-169-2024-13 (20-24 AWG)	Mini Applicator: CAT-MC-169-1620-XX-02 (16-20 AWG) Mini Applicator: CAT-MC-169-2024 XX-01 (20-24 AWG) Extraction Tool: CAT-EX-169-01
--	--

Note: Some lengths, styles and options are non-standard, non-returnable.

View complete specifications at: samtec.com?IPBD, samtec.com?CC69L & samtec.com?CC69R



SERIES	PINS PER ROW	WIRE GAUGE	PLATING OPTION	ASSEMBLY LENGTH	END OPTION	K	LATCH OPTION
MMSD = Double Row PVC Cable	-02, -03, -04, -05, -06, -08, -10, -12, -15, -16, -20, -25 (Standard sizes)	-20 -20C = Color Coded Cable (MMSD & MMSS only)	-L = 10 μ" (0.25 μm) Gold on contact, Tin on tail	-"XX.XX" = Assembly Length in Inches (82.55 mm) 03.25" min.	-S = Single Ended -D = Double Ended (Latch Required)	-K = Keyed Polarization	(Metal latches for more rugged environments; -02, -05 & -10 positions only) -M = Single Ended, Metal Latches (Leave blank for plastic) Double Ended (-D) Crossed requires MMSD/MMSDT -LUS = Plastic Latch up, straight -LDS = Plastic Latch down, straight -LUX = Plastic Latch up, crossed -LDX = Plastic Latch down, crossed -MUS = Metal Latch up, straight -MDS = Metal Latch down, straight -MUX = Metal Latch up, crossed -MDX = Metal Latch down, crossed
MMSDT = Double Row Blue *Teflon™ Fluoropolymer Cable (20, 24, 28, 30 AWG only)		-24C = Color Coded Cable (MMSD & MMSS only)					
MMSS = Single Row PVC Cable		-26, -28					
MMSST = Single Row Blue *Teflon™ Fluoropolymer Cable (20, 24, 28, 30 AWG)		-28C = Color Coded Cable (MMSD & MMSS only)					
MMSD, MMSDT, MMSS, MMSST Board Mates: IPL1 (Does not mate with IPT1) Cable Mates: MMTD(T), MMTS(T)		-30					

PIN	COLOR
1	BROWN
2	RED
3	ORANGE
4	YELLOW
5	GREEN
6	BLUE
7	VIOLET
8	GRAY
9	WHITE
10	BLACK
ETC	REPEAT

SPECIFICATIONS

Insulator Material: Nylon 66
Contact Material: Phosphor Bronze
Plating: Au or Sn over 50 μ" (1.27 μm) Ni
Voltage Rating: 300 VAC

*Teflon™ is a trademark of The Chemours Company FC, LLC used under license by Samtec.
 Teflon™ Fluoropolymer cable is intended for crimp only. Contact Samtec for solderable cable applications.

View complete specifications at: samtec.com?MMSD, samtec.com?MMSDT, samtec.com?MMSS & samtec.com?MMSST

IPD1	POSITIONS PER ROW	ROW OPTION	K	LATCH OPTION	SERIES	WIRE GAUGE	01	PLATING OPTION
	-02, -03, -04, -05, -06, -08, -10, -12, -15, -16, -20, -25 (Standard sizes)	-S = Single Row -D = Double Row	-K = Keyed Polarization	-M = Metal Latch (Metal for more rugged environments) (-02, -05 & -10 positions only) (Leave blank for plastic latch)	CC79L = Contact, Loose CC79R = Contact, Full Reel (12,000 Parts per Reel)	-2630 = 26 to 30 AWG -2024 = 20 to 24 AWG		-L = 10 μ" (0.25 μm) Gold on contact, Tin on tail

TOOLING

Hand Tool: CAT-HT-179-2030-13 (20-30 AWG)

Mini Applicator: CAT-MC-179-2024-XX-01 (20-24 AWG)
 Mini Applicator: CAT-MC-179-2630 XX-01 (26-30 AWG)
 Extraction Tool: CAT-EX-179-01

Not: Some lengths, styles and options are non-standard, non-returnable.

View complete specifications at: samtec.com?IPD1, samtec.com?CC79L & samtec.com?CC79R

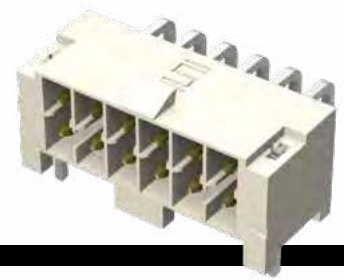

IPL1	1	PINS PER ROW	LEAD STYLE	PLATING OPTION	ROW OPTION	TAIL OPTION	K	OPTION
		02, 03, 04, 05, 06, 08, 10, 12, 15, 16, 20, 25 (Standard sizes)	-01 = Through-hole -02 = Surface Mount	-L = 10 μm (0.25 μm) Gold on contact, Matte Tin on tail	-S = Single Row -SH = Single Row Horizontal (-02 lead style only) -D = Double Row	-RA = Right-angle (-01 lead style only) -RE1 = Right-angle Elevated (-01 lead style only) (-K is a required callout)	-K = Keyed Polarization	-TR = Tape & Reel (-02 lead style only) Comes with Polyimide Pick & Place Pad -FR = Full Reel Tape & Reel (must order max. quantity per reel; contact Samtec for quantity breaks) (-02 lead style only) Comes with Polyimide Pick & Place Pad

IPL1

Cable Mates:

MMSD, MMSS,
MMSDT, MMSST

SPECIFICATIONS

Insulator Material:

Natural LCP

Terminal Material:

Phosphor Bronze

Plating:

Sn or Au over

50 μm (1.27 μm) Ni

Operating Temp Range:

-55 °C to +125 °C

Voltage Rating:

675 VAC/954 VDC

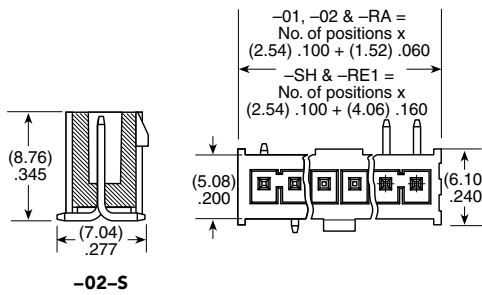

MMSD/IPL1	
WIRE GAUGE	CURRENT RATING (PER PIN)
20	4.8 A
22	4.3 A
24	3.9 A
26	3.5 A
28	2.6 A
30	2.1 A

2 PINS POWERED

PROCESSING

Lead-Free Solderable:

Yes

-S & -D (-02 Lead Style)

SMT Lead Coplanarity:

(0.10 mm) .004" max (02-05)

(0.13 mm) .005" max (06-10)*

(0.15 mm) .006" max (11-25)*

*(.004" stencil solution

may be available; contact

IPG@samtec.com)

-SH SMT Lead Coplanarity:

(0.15 mm) .006" max (02-25)*

*(.004" stencil solution

may be available; contact

ipg@samtec.com)

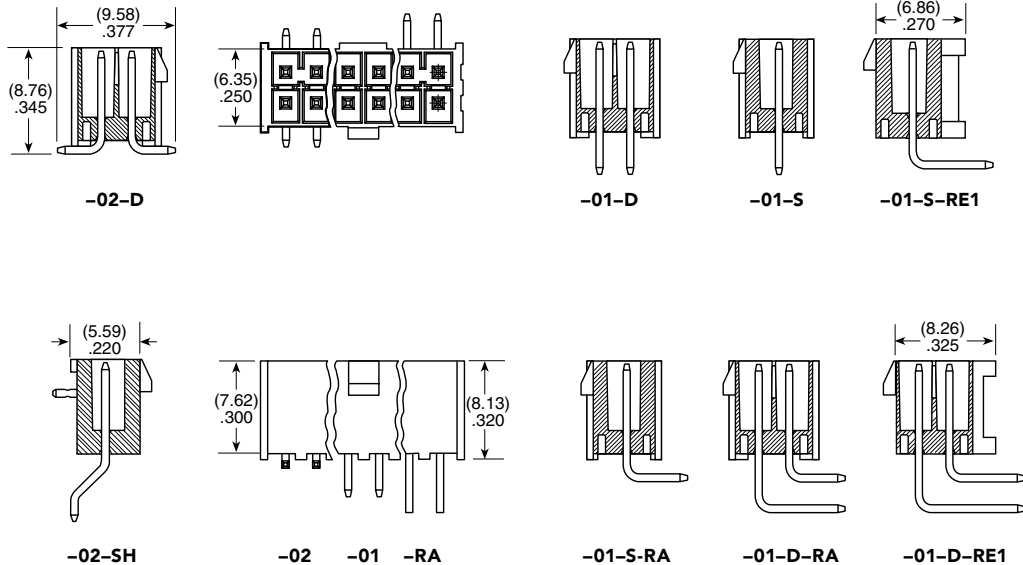

ALSO AVAILABLE

MOQ Required

Other sizes

With or without plug polarization

Guide post holes

Other platings

Weld tab

Note:

Some lengths, styles and options are non-standard, non-returnable.

View complete specifications at: samtec.com?IPL1



(5.00 mm) .1969" PITCH • 30 A CABLE ASSEMBLY/COMPONENTS

MPSS	NO. OF POSITIONS	WIRE GAUGE	PLATING OPTION	ASSEMBLED LENGTH	END 1 OPTION	END 2 OPTION
------	------------------	------------	----------------	------------------	--------------	--------------

-02, -03,
-04, -06, -08

-14
-16

-L
= 10 μ" (0.25 μm)
Gold on contact

-T
= Matte Tin

-"XX.XX"
= Wire length in
inches (83.00 mm)
03.25" min.

-SR
= Single End

-DR
= Double End

(Available with -DR only)

-NUS
= Notch up, straight

-NDS
= Notch down, straight

MPSS

Board Mates:

MPT

SPECIFICATIONS

Insulator Material:

Nylon 6/6

Contact Material:

Copper Alloy

Plating:

Au or Sn over

50 μ" (1.27 μm) Ni

Latch:

Nylon 6/6

Operating Temp Range:

-30 °C to +105 °C

Voltage Rating:

600 VAC/848 VDC

Wire:

14 or 16 AWG

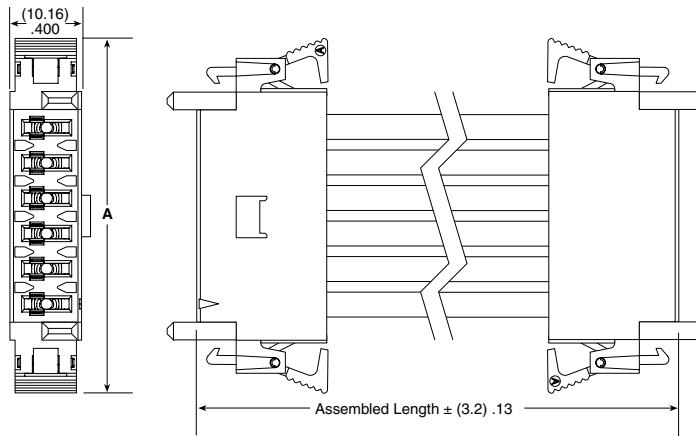

NO. OF POSITIONS	A
-02	(30.07) 1.184
-03	(35.07) 1.381
-04	(40.08) 1.578
-06	(50.09) 1.972
-08	(60.10) 2.366

MPSS/MPT-V	
WIRE GAUGE	CURRENT RATING (PER PIN)
14 AWG	19.7 A
16 AWG	15.9 A
1 PIN POWERED	

View complete specifications at: samtec.com?MPSS

IMS5	POSITIONS PER ROW	02	SERIES	WIRE GAUGE	01	PLATING OPTION
------	-------------------	----	--------	------------	----	----------------

-02, -03, -04, -06, -08

CC46L
= Contact, Loose

-1416
= 14 to 16 AWG

-L
= 10 μ"
(0.25 μm)
Gold on contact

CC46R
= Contact,
Full Reel

-T
= Matte Tin

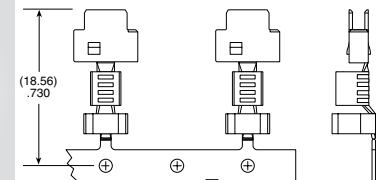
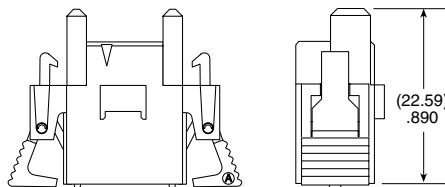
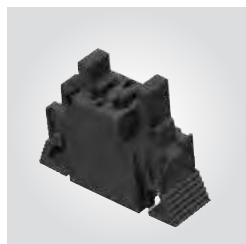

TOOLING

Hand Tool: CAT-HT-246-1416-14 (14-16 AWG)

Mini Applicator: CAT-MC-246-1416-XX-02 (14-16 AWG)

Extraction Tool: CAT-EX-MPSS-01

Note:

Some lengths, styles and options are non-standard, non-returnable

View complete specifications at: samtec.com?IMS5, samtec.com?CC46L & samtec.com?CC46R



30 SIGNAL/POWER COMBO CABLE ASSEMBLY/COMPONENTS

MPCC	2	SIGNAL PINS	2	PLATING OPTION	LEAD STYLE	LENGTH	END 1 OPTION	END 2 OPTION
		-16 = Total Signal Pins		-L = 10 μ" (0.25 μm) Gold on contact, Tin on tail (Power & Signal)	Specify LEAD STYLE from chart	-"XX.XX" = Assembled Length in Inches (101.60 mm) 04.00" min.	-S = Single End	(Available with -D only)
		-24 = Total Signal Pins		-T = Tin on contact and tail (Power), Gold on contact, Tin on tail (Signal)			-D = Double End	-NUS = Notch up, straight (Pin A1 to Pin AX)

MPCC
Board Mates:
MPTC

SPECIFICATIONS

Insulator Material:
Black LCP
Contact Material:
Signal: BeCu
Power: Copper Alloy
Plating:
Sn or Au over 50 μ" (1.27 μm) Ni
Current Rating:
Signal Pin (24 AWG):
3.4 A per pin
(4 adjacent pins powered)
Power Pin (14 AWG):
23.2 A per pin
(1 pin powered)
Operating Temp Range:
-10 °C to +105 °C
Voltage Rating:
250 VAC

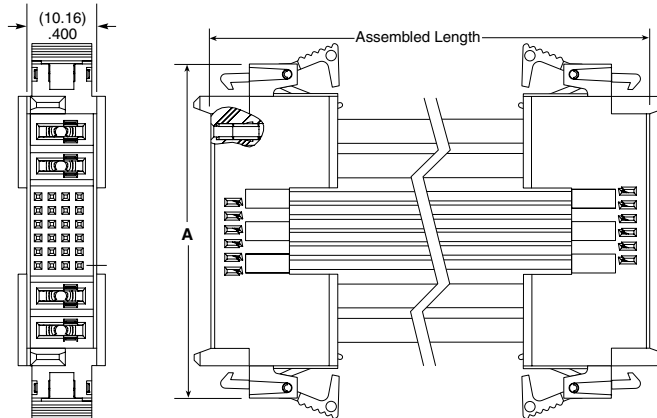

SIGNAL PINS	A
16	(44.55) 1.754
24	(48.55) 1.911

LEAD STYLE	PWR/SIG	AWG
-44	PWR	14
	SIG	24
-46	PWR	14
	SIG	26
-48	PWR	14
	SIG	28
-40	PWR	14
	SIG	30
-64	PWR	16
	SIG	24
-66	PWR	16
	SIG	26
-68	PWR	16
	SIG	28
-60	PWR	16
	SIG	30

View complete specifications at: samtec.com?MPCC

IMSC5	POWER PINS	SIGNAL PINS	POWER PINS	L	SERIES	WIRE GAUGE	01	PLATING OPTION
	-02 = Power Pins Per End	-16 = Total Signal Pins	-02 = Power Pins Per End	-L = Latch	CC81L = Contact, Loose	-2426 = 24 to 26 AWG		-L = 10 μ" (0.25 μm) Gold on contact
		-24 = Total Signal Pins			CC81R = Contact, Full Reel (17,000 Parts per Reel)	-2830 = 28 to 30 AWG		

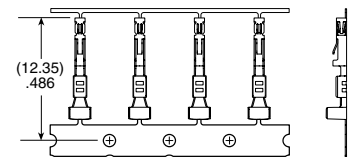
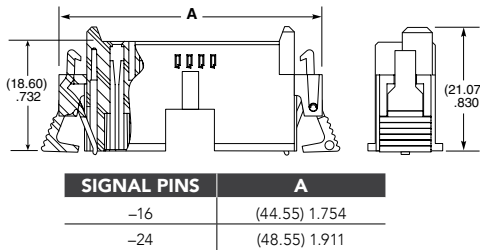

Note: Power contact (CC46 Series) information on page 246.

TOOLING

Hand Tool: CAT-HT-281-2430-13 (Signal: 24-30 AWG)
CAT-HT-246-1416-13 (Power: 14-16 AWG)

Extraction Tool: CAT-EX-169-01 (Signal)
CAT-EX-MPSS-01 (Power)

Mini Applicator: CAT-MC-246-1416-XX-01 (Power 14-16 AWG)
CAT-MC-281-2426-XX-01 (Signal: 24-26 AWG)
CAT-MC-281-2830-XX-01 (Signal: 28-30 AWG)

Note: Some lengths, styles and options are non-standard, non-returnable

View complete specifications at: samtec.com?IMSC5, samtec.com?CC81R & samtec.com?CC81L



(6.35 mm) .250" PITCH • 40 A CABLE ASSEMBLY/COMPONENTS

PESS	NO. OF POSITIONS	WIRE GAUGE	PLATING OPTION	ASSEMBLED LENGTH	END 1 OPTION	END 2 OPTION
	-02, -04, -06, -08	-10 -12	-L = 10 μ" (0.25 μm) Gold on contact, Matte Tin on tail -T = Matte Tin on tail	-"XX.XX" = Wire length in inches (152.4 mm) 06.00" min.	-SR = Single End -DR = Double End	(Available with -DR only) -NUS = Notch up, straight (Available with -DR only) -NDS = Notch down, straight

PESS
Board Mates:
PET

SPECIFICATIONS

Insulator Material:
Nylon Black
Contact Material:
Copper Alloy
Plating:
Sn or Au over
50 μ" (1.27 μm) Ni
Operating Temp Range:
-30 °C to +105 °C
Voltage Rating:
600 VAC
846 VDC
Wire:
10 or 12 AWG

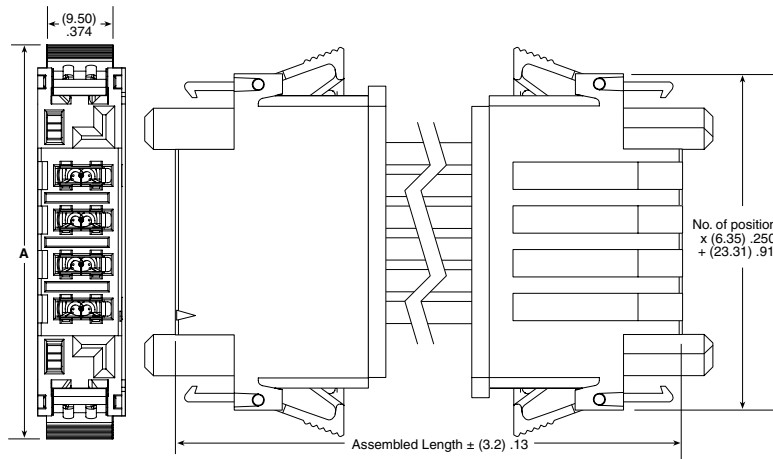

NO. OF POSITIONS	A
-02	(43.9) 1.73
-04	(56.6) 2.23
-06	(69.3) 2.73
-08	(82.0) 3.23

PESS/PET	
WIRE GAUGE	CURRENT RATING (PER PIN)
10 AWG	34.5 A
12 AWG	29.7 A
1 PIN POWERED	

View complete specifications at: samtec.com?PESS

IPS6	POSITIONS PER ROW	01	LATCH	SERIES	WIRE GAUGE	PLATING OPTION
	-02, -04, -06, -08		-L = Latch	CC10R = Contact, Full Reel CC10L = Contact, Loose	-1012 = 10 to 12 AWG	-L = 10 μ" (0.25 μm) Gold on contact, Matte Tin on tail -T = Matte Tin on tail

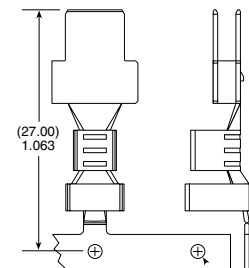
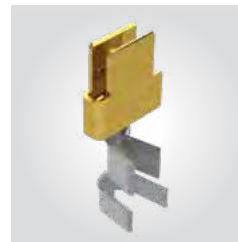
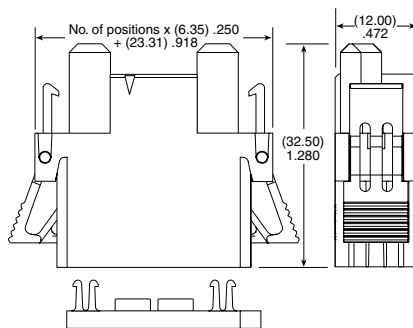

TOOLING

Hand Tool: CAT-HT-310-1012-14
Mini Applicator: CAT-MC-310-1012-XX-02

Note:
Some lengths, styles and options are non-standard, non-returnable

View complete specifications at: samtec.com?IPS6, samtec.com?CC10L & samtec.com?CC10R

FLEXIBLE STACKING

VARIETY OF PITCHES, CONTACT SYSTEMS & ORIENTATIONS • HIGHLY CUSTOMIZABLE



254-255

ONE-PIECE INTERFACES

1.00 mm (.0394") Pitch (FSI)	254
1.00" (2.54 mm) (SIB, SIR1)	255

256-261

MICRO BLADE & BEAM

0.50 mm (.0197") Pitch Low Profile Systems (LTH, LSH)	256
Floating Contact Systems (FT5, FS5)	257
Basic Blade & Beam Systems (BXH, BXS, BXE)	258-261

262-278

MICRO PIN & SOCKET

0.80 mm (.0315") Pitch Headers & Sockets (FTE, CLE, AW)	262-263
1.00 mm (.0394") Pitch Headers, Stackers & Sockets (FTMH, FTM, MW, CLM, MLE)	264-266
Quad Row Headers & Sockets (SOLC, TOLC)	267
.050" (1.27 mm) Pitch Headers, Stackers & Sockets (FTSH, FTS, FW, CLP, FLE)	268-273
.050" (1.27 mm) x 100" (2.54 mm) Pitch Headers, Stackers & Sockets (TMS, HTMS, TML, ZML, DWM, FTR, RSM, SLM, SMS)	274-278

279-312

BOARD-TO-BOARD

2.00 mm (.0787") Pitch Headers & Stackers (TMM, MMT, MTMM, TMMH, LTMM, ZLTMM, TMMS, TSH, TW)	279-286
2.00 mm (.0787") Pitch Press-Fit Headers & Sockets (PTT, PTF, PTHF, ESQT-368)	287-288
2.00 mm (.0787") Pitch Sockets (SQW, SQT, MMS, TLE, CLT)	289-291
2.00 mm (.0787") Pitch Self Mating Hermaphroditic Strips (LS2)	292
.100" (2.54) Pitch Square Post Headers & Stackers (PHT, PHF, TSW, HTSW, TSM, MTSW, HMTSW, TLW, MTLW, HW, DW, EW, ZW, TSS, HTSS, ZSS)	293-303
.100" (2.54 mm) Pitch Square Post Sockets (SSW, SSQ, SSM, ESW, ESQ, HLE, BCS, BSW, SLW, CES)	304-311
Shunts & Jumpers (SNT, MNT, 2SN, SNM, JL)	312

FLEXIBLE STACKING

With the largest variety of board-to-board interconnects, Samtec makes it easy to find board stackers for any application. Header and socket systems are available in a variety of pitch, density, stack height, orientation and many more standard or custom options.

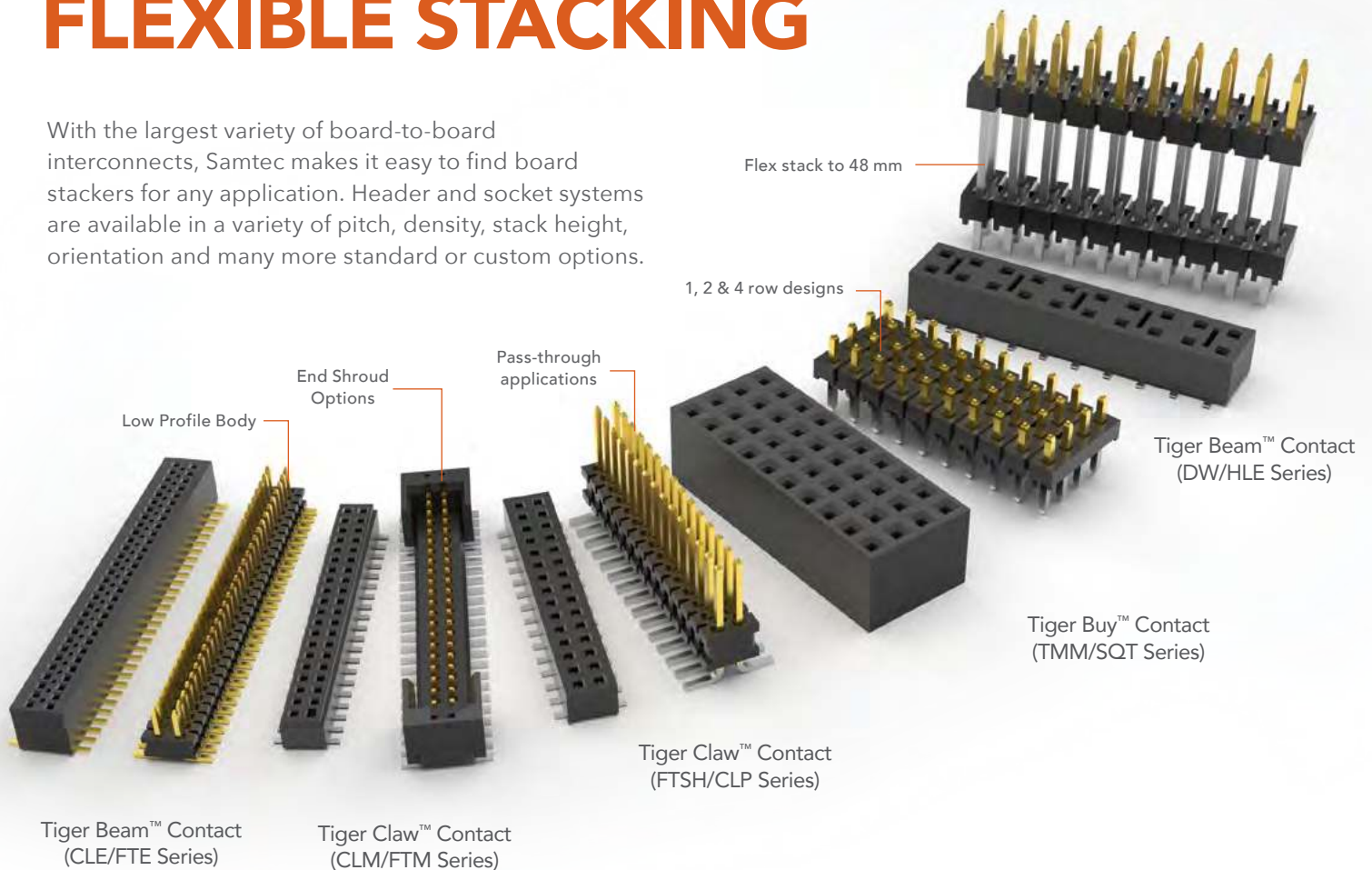

INCREDIBLE FLEXIBILITY

- Post height: Adjustable in .005" (0.13 mm) increments
- Body positions: Adjustable in .005" (0.13 mm) increments
- Board stacking distance: 1.65 mm (.065") – 48.51 mm (1.910")
- Number of pins: 2-300
- Number of rows: 1-6

CUSTOMIZABLE

- Mix-and-match headers and sockets to find the right solution
- Quick and easy custom parts are available. Contact asp@samtec.com

VARIETY OF PITCHES

- 0.80 mm (.0315")
- 1.00 mm (.0394")
- .050" (1.27 mm)
- .050" x .050" (1.27 x 1.27 mm)
- .050" x .100" (1.27 x 2.54 mm)
- 2.00 mm (.0787")
- .100" (2.54 mm)
- .156" (3.96 mm)
- .200" (5.08 mm)

BUILD IT YOURSELF

Check out Solutionator® to quickly build a mated set for your specific application. Visit samtec.com/solutionator

Solutionator
GET A MATED SET IN SECONDS

FLEX
STACKING

VARIETY OF CONTACTS

TIGER EYE™ CONTACT

- High-reliability
- High mating cycles
- Multi-finger contact



TIGER CLAW™ CONTACT

- Pass-through
- Ultra-low profile
- Dual wipe contact

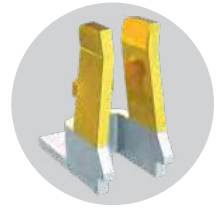

TIGER BUY™ CONTACT

- High-retention
- Cost-effective
- Tuning fork contact

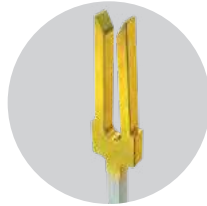

TIGER BEAM™ CONTACT

- Best cost
- Reliable performance
- Post & beam contact



VARIETY OF ORIENTATIONS/APPLICATIONS

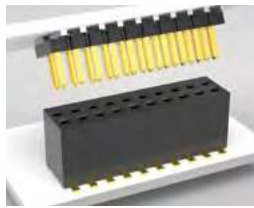

Standard

- Choice of contact system
- Single, double and triple row designs
- Largest variety

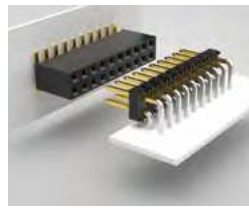

Right-Angle

- Design flexibility
- Tiger Claw™ & Tiger Buy™ contacts
- Through-hole, surface mount



Low Profile

- Down to 1.65 mm (.065") stack height
- Tiger Claw™ contacts
- Space saving

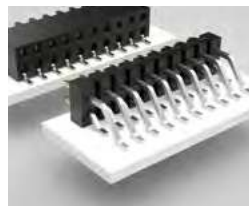

Coplanar

- 1-4 row designs
- Surface mount, through-hole or mixed technology
- Tiger Claw™ & Tiger Beam™ contacts



Elevated

- Up to 48.51 mm (1.910") stack height
- Design flexibility
- Clearance, air flow

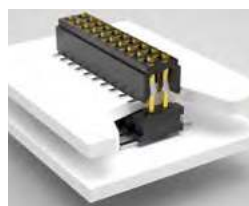

Bottom Entry

- Tiger Claw™ contacts
- Access to components when mated
- Space savings



Pass-Through

- Connect three or more boards
- Tiger Claw™ & Tiger Beam™ contact systems
- Surface mount or offset through-hole



Self-Nesting

- Tiger Buy™ contacts
- Press-fit or through-hole tails
- PC/104-Plus™ embedded applications

BOARD STACKING REFERENCE

Focused/most popular series in charts. For all flexible stacking solutions, visit samtec.com/connectors

ONE-PIECE, 0.80 mm (.0315") & 1.00 mm (.0394") PITCH



SERIES	FSI	SEI	SIB	CLE	FTE	CLM	FTMH/FTM	MLE	MW	
PITCH	1.00 mm (.0394")		.100" (2.54 mm)	0.80 mm (.0315")		1.00 mm (.0394")				
ORIENTATION	V				V & RA	V	V & RA	V		
BOARD STACKING (MM)	MIN	3	1.65	3.8	5	5	3.48		4.57	4.62
	MAX	10			9.14		8.43	5.11	9.27	
CONTACT SYSTEM					Tiger Beam™		Tiger Claw™		Tiger Beam™	
MATES	One-Piece				FTE, AW	CLE	FTM, FTMH, MW	CLM, MLE	FTM, FTMH, MW	CLM, MLE
PAGE	254	See Website	255	262	262	266	264	266	265	

.050" (1.27 mm) PITCH HEADERS & SOCKETS

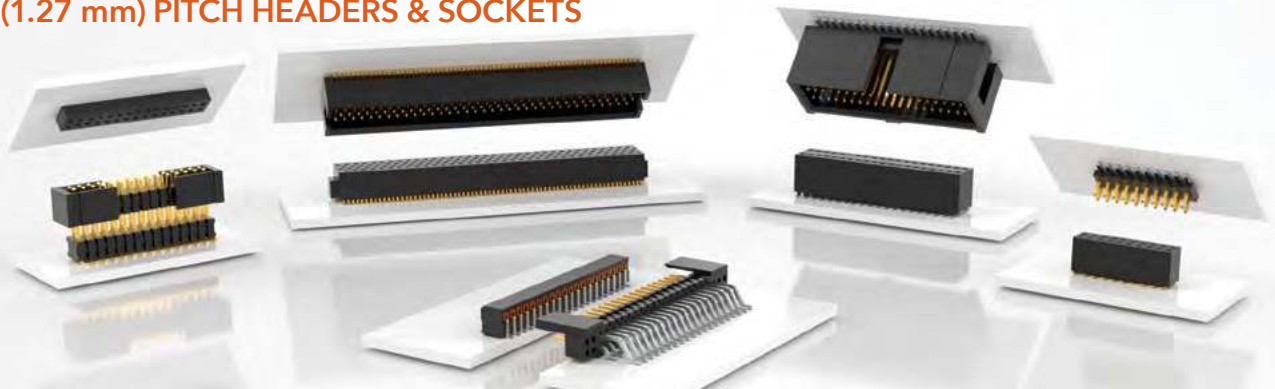

SERIES	CLP	FLE	FTS	FTSH	FW	SOLC	TOLC	DWM/HDWM	FTR	RSM	SLM
PITCH	.050" x .050" (1.27 mm x 1.27 mm)							.050" x .100" (1.27 mm x 2.54 mm)			
ORIENTATION	V & RA	V		V & RA	V						
BOARD STACKING (MM)	MIN	3.53	5.82	3.53	5.18	7.72	6.35	9.65	9.78		7.11
	MAX	17.75	19.15	5.82	7.49	19.15	12.00	22.99	14.73	19.69	19.43
CONTACT SYSTEM	Tiger Claw™	Tiger Beam™				Tiger Buy™					Tiger Buy™
MATES	FTSH, FTS, FW			CLP, FLE		TOLC	SOLC	SMS, SLM, RSM		FTR, HTMS, HDWM, DWM, TML, ZML, TMS	HTMS, TMS, MTMS, DWM, HDWM, FTR, HMTMS
PAGE	272	273	270	268-269	271	267	267	276	277	277	278

2.00 mm (.0787") PITCH HEADERS & SOCKETS



SERIES	MMT	TMM/ MTMM	TMMH	TW	ZLTMM	CLT	ESQT/ -368	MMS	SMM	SQT	SQW	TLE
ORIENTATION	RA	V & RA		V				V & RA	V	V & RA	V	
TERMINATION	SMT & MT	T/H & SMT			T/H	T/H & SMT	T/H	T/H & SMT	SMT	T/H	T/H & SMT	SMT
BOARD STACKING (MM)	MIN	2	3.63	4.14	7.49	7.62	3.63	9.37	5.94	6.07	7.85	6.99
	MAX	4	18.87	22.07	43.31	13.34	4.98	43.31	19.81	17.78	29.59	17.53
CONTACT SYSTEM						Tiger Claw™	Tiger Buy™	Tiger Claw™	Tiger Eye™	Tiger Buy™		Tiger Beam™
MATES	CLT, SQT, SQW, ESQT, TLE, SMM, MMS				SQT, SQW, ESQT, SMM	TMM, TMMH, MTMM, MMT, TW, TSH	TMMH, TMM, MTMM, MMT, TW, ZLTMM, TSH	TMM, TMMH, MTMM, MMT, TW, ZLTMM	TMMH, TMM, MTMM, MMT, TW, LTMM, ZLTMM, PTT, ESQT, TSH	TMMH, TMM, MTMM, MMT, TW, TSH, LTMM, PTT	TMMH, TMM, MTMM, MMT, TW, TSH, LTMM, PTT	TMMH, TMM, MTMM, MMT, TW, LTMM, ZLTMM, TSH
PAGE	281	279-281	282-283	286	284	291	288	290	230	289	289	291

.100" (2.54 mm) PITCH HEADERS & SOCKETS



SERIES	DW, EW, ZW	HW	MTSW/ HMTSW	TLW/ MTLW	TSM	TSW/ HTSW	BCS	ESW, ESQ	HLE	SSM	SSQ	SSW
ORIENTATION	V		V & RA				V & RA	V			V & RA	
TERMINATION	T/H	T/H & SMT	T/H		SMT & MT	T/H			T/H & SMT	SMT	T/H	T/H & SMT
BOARD STACKING (MM)	MIN	13.59	10.03	7.24	6.1	7.47	7.87	9.02	13.59	7.47	11.18	10.03
	MAX	48.51	30.73	46.36	20.96	14.48	35.69	18.92	48.51	26.16	30.1	38.35
CONTACT SYSTEM							Tiger Claw™	Tiger Buy™	Tiger Beam™	Tiger Claw™	Tiger Buy™	
MATES	SSW, SSQ, ESW, ESQ, CES, SLW, BSW, BCS, SSM, HLE, PHF		SSW, SSQ, ESW, ESQ, BCS, BSW, CES, SLW, HLE, SSM	BSW, CES, SLW, HLE	SSW, SSQ, SSM, BSW, ESW, ESQ, BCS, BSW, CES, SLW, HLE	SSW, SSQ, SSM, ESW, ESQ, BCS, BSW, CES, SLW	TSW, MTSW, HTSW, HMTSW, TSS, ZSS, DW, EW, ZW, HW, TSM, MTLW, PHT	TSW, MTSW, EW, MTLW, TSS, ZSS, TSM, DW, ZW, HW, TSSH, HTSS	TSW, MTSW, DW, EW, ZW, TLW, TSM, MTLW, HW	TSW, MTSW, TST, TSS, ZST, ZSS, DW, EW, ZW, TSM, HMTSW, HTSW, TSSH, BST, HTSS, TLW, MTLW	TSW, MTSW, MTLW, EW, ZW, TSS, ZSS, TSM, TSSH, HTSS	TSW, MTSW, HTSW, HMTSW, MTLW, EVW, ZW, TSS, HTSS, ZSS, TSM, TSSH, DW, HW
PAGE	302	301	298-299	300	296-297	294-295	309	307	308	306	304-305	

LOW PROFILE AND ELEVATED ONE-PIECE

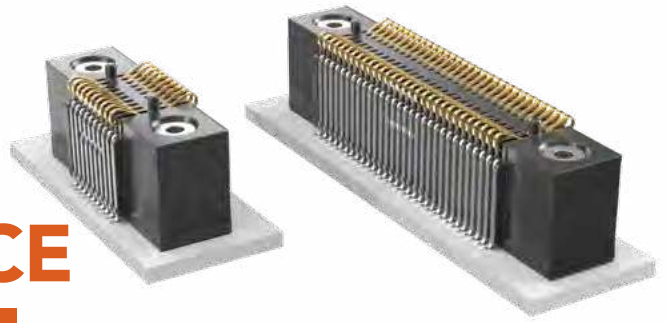

(1.00 mm) .0394" PITCH • FSI SERIES

SPECIFICATIONS

Insulator Material:
Liquid Crystal Polymer
Contact Material:
BeCu
Current Rating:
2.8 A per pin
(2 pins powered)
Operating Temp Range:
-55 °C to +125 °C
Plating:
Au over 50 μ" (1.27 μm) Ni

PROCESSING

Lead-Free Solderable:
Yes
SMT Lead Coplanarity:
(0.10 mm) .004" max (05-30)
(0.15 mm) .006" max (50)*
*(.004" stencil solution may be available; contact ipg@samtec.com)
Compression Board:
Gold Pads required

OTHER SOLUTIONS

Low Profile

See www.samtec.com?SEI

.050" (1.27 mm) Pitch

See www.samtec.com?SIBF

FSI	1	PINS PER ROW	BODY HEIGHT	PLATING OPTION	ROW OPTION	INSERT OPTION	ALIGNMENT OPTION	OTHER OPTION
-----	---	--------------	-------------	----------------	------------	---------------	------------------	--------------

10, 20,
30, 50
(Insert/Screw
Option)

-03
= 3 mm

-06
= 6 mm

-10
= 10 mm

-G
= 10 μ"
(0.25 μm)
Gold
(-03 only)

-L
= 10 μ"
(0.25 μm)
Gold on
contact,
Matte Tin
on tail
(Not
available
with
-03 body
height)

-S
= Single
Row
(Available
with 5, 10
& 20 pins
with -AD
alignment
pin)

-D
= Double
Row

Leave blank
for Short
Version
(No screw
down
inserts or
holes)

-E
= #2-56 x
1/16" screw
thread

-M
= 2.00 mm
x 0.40 mm
screw thread

Leave blank
for no
Alignment Pin

-AD
= Alignment Pin
Top & Bottom

-WT
= Weld Tab
(Available
with -S row
option & -06
& -10 body
height only)

-K
= Polyimide
Film Pick &
Place Pad
(50 position
with threaded
insert option
only)

-P
= Plastic Pick
& Place Pad
(5.08 mm)
.200" x
(12.45 mm)
.490"
(50 not
available
with -E)
(Not available
with -S
row option
or -03 body
height)

-TR
= Tape &
Reel

-FR
= Full Reel
Tape & Reel
(must order
max. quantity
per reel;
contact
Samtec for
quantity
breaks)

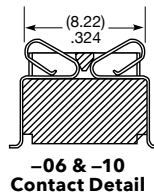
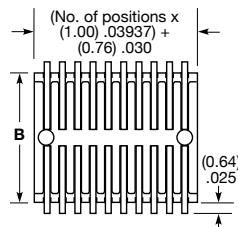

-06 & -10
Contact Detail

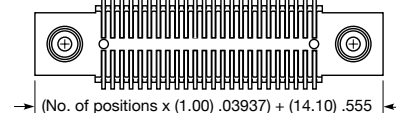

Insert Option (10, 20 & 30 pins/row)

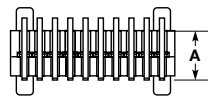

Short Version

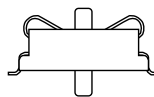

-03-AD
Shown

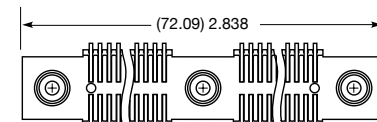

Insert Option (50 pins/row)

Double Row Version -03, -06, -10

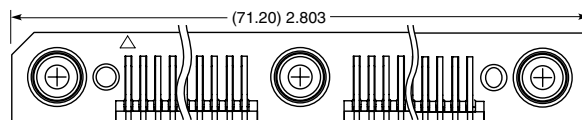

Insert Option (50 pins/row)

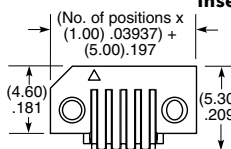

-03, -06 & -10
Contact Detail

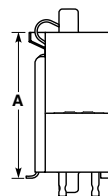

-WT Option
(-06 & -10 Body only)

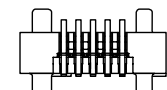

Short Version

-03-AD Shown

Single Row Version -03, -06, -10

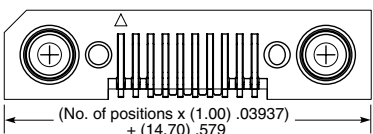

Insert Option (10, 20 & 30 pins/row)

BODY HEIGHT	A	B
-03	(3.00) .118	(8.76) .345
-06	(6.00) .236	(9.02) .355
-10	(10.00) .394	(9.02) .355

ALSO AVAILABLE

MOQ Required

No alignment pin
Top side alignment pin
Bottom side alignment pin
Other platings

Notes:
Applications requiring 40-50
positions without threaded
inserts, please contact
Samtec Interconnect
Processing Group.

Some lengths, styles and
options are non-standard,
non-returnable.

ONE-PIECE INTERFACES

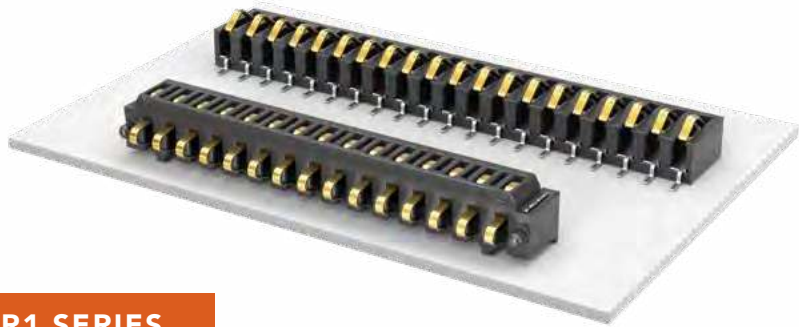

(2.54 mm) .100" PITCH • SIB/SIR1 SERIES

SPECIFICATIONS

Insulator Material:
Black Liquid Crystal Polymer
Contact Material:
Phosphor Bronze
Plating:
Au or Sn over
50 μ " (1.27 μ m) Ni
Current Rating:
2.6 A per pin
(1 pin powered)
Operating Temp Range:
-55 °C to +125 °C

SIB	-	1	NO. OF POSITIONS	-	02	PLATING OPTION	-	S	-	OPTION
------------	---	----------	-------------------------	---	-----------	-----------------------	---	----------	---	---------------

02 thru 30
(Per Row)

-F
= Gold flash
on contact,
Matte Tin on tail

-LC
= Locking
Clip
(Manual
placement
required)

PROCESSING

Lead-Free Solderable:
Yes
SMT Lead Coplanarity:
(0.10 mm) .004" max (02-19)
(0.15 mm) .005" max (20-30)*
*(.004" stencil solution
may be available; contact
ipg@samtec.com)

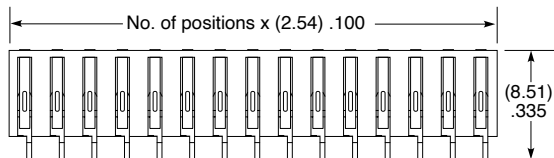

Notes:
The SIB Series
is intended for vertical
mating only.

Some lengths, styles and
options are non-standard,
non-returnable.

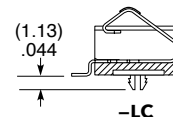
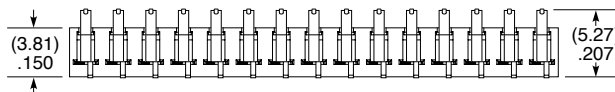

-LC

SPECIFICATIONS

Insulator Material:
Black LCP
Contact Material:
Phosphor Bronze
Weld Tab:
Phosphor Bronze
Plating:
Au or Sn over
50 μ " (1.27 μ m) Ni
Current Rating:
2.8 A per pin
(1 pin powered)

SIR1	-	NO. OF POSITIONS	-	PLATING OPTION	-	S	-	OPTION
-------------	---	-------------------------	---	-----------------------	---	----------	---	---------------

-03, -05, -10, -15
(Per Row)

-L
= 10 μ " (0.25 μ m)
Gold on contact,
Matte Tin on tail

-S
= 30 μ " (0.76 μ m)
Gold on contact,
Matte Tin on tail

-A
= Alignment Pin

-K
= (4.00 mm) .157"
DIA Polyimide
Film Pick &
Place Pad

-TR
= Tape & Reel

-FR
= Full Reel
Tape & Reel
(must order max.
quantity per reel;
contact Samtec for
quantity breaks)

PROCESSING

Lead-Free Solderable:
Yes
SMT Lead Coplanarity:
(0.10 mm) .004" max

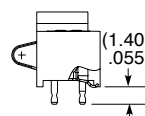
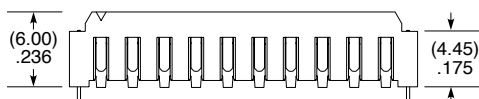
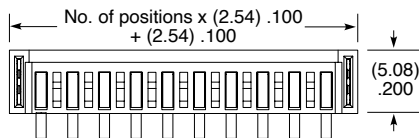

Note:
Some lengths, styles and
options are non-standard,
non-returnable.

LOW PROFILE BLADE AND BEAM

(0.50 mm) .0197" PITCH • LTH/LSH SERIES



LTH
Mates:
LSH

LSH
Mates:
LTH

LTH	NO. OF POSITIONS PER ROW	01	PLATING OPTION	D	A	OTHER OPTION
------------	---------------------------------	-----------	-----------------------	----------	----------	---------------------

-010, -020,
-030, -040, -050

-G
= 10 μm
(0.25 μm)
Gold

-K
= (5.50 mm)
.217" DIA
Polyimide
film Pick &
Place Pad

-TR
= Tape & Reel

-FR
= Full Reel
Tape & Reel
(must order max.
quantity per reel;
contact Samtec for
quantity breaks)

SPECIFICATIONS

Insulator Material:

Liquid Crystal
Polymer

Terminal Material:

Phosphor Bronze

Contact Material:

BeCu

Plating:

Au over 50 μm (1.27 μm) Ni

Current Rating:

2.6 A per pin
(2 pins powered)

Operating Temp Range:

-55 °C to +125 °C

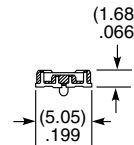
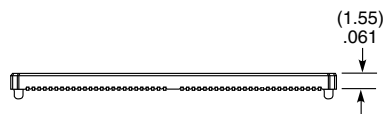
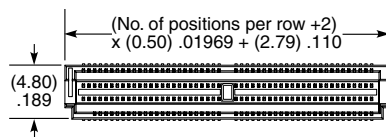

PROCESSING

Lead-Free Solderable:

Yes

SMT Lead Coplanarity:

(0.10 mm) .004" max

Board Stacking:

For applications requiring more than two connectors per board, contact ipg@samtec.com

LSH	NO. OF POSITIONS PER ROW	01	PLATING OPTION	D	A	OTHER OPTION
------------	---------------------------------	-----------	-----------------------	----------	----------	---------------------

-010, -020,
-030, -040, -050

-G
= 10 μm
(0.25 μm)
Gold

-K
= (7.50 mm)
.295" DIA
Polyimide
film Pick &
Place Pad

-TR
= Tape & Reel

-FR
= Full Reel
Tape & Reel
(must order max.
quantity per reel;
contact Samtec for
quantity breaks)

MATED HEIGHT

LEAD STYLE	MATED HEIGHT*
-01	(2.31 mm) .091"

*Processing conditions will affect mated height.

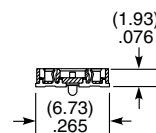
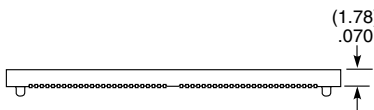
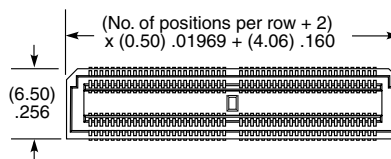

Note:
Some lengths, styles and options are non-standard, non-returnable.

HIGH-SPEED FLOATING CONTACT SYSTEM

(0.50 mm) .0197" PITCH • FT5/FS5 SERIES



FT5
Mates:
FS5

FS5
Mates:
FT5

SPECIFICATIONS

Insulator Material:
Black Liquid Crystal Polymer
Contact Material:
Phosphor Bronze (FT5)
BeCu (FS5)
Weld Tab:
Phosphor Bronze
Plating:
Au or Sn over
50 μ" (1.27 μm) Ni
Current Rating:
1.8 A per pin
(2 pins powered)
Operating Temp Range:
-55 °C to +125 °C
Lead-Free Solderable:
Yes

FT5	NO. OF POSITIONS	LEAD STYLE	PLATING OPTION	ROW OPTION	TH	OPTION
-----	------------------	------------	----------------	------------	----	--------

-15, -30
(Per Row)

-01.0
= 1 mm
Body
Height

-L
= 10 μ"
(0.25 μm)
Gold on
contact,
Matte Tin
on tail

-DV
= Vertical

Leave blank
for -RA

Required
callouts

-RA
= Right-
angle

-TH
= Through-hole
weld tab

-P
= Pick &
Place Pad
(-DV only)

-K
= (5.00 mm)
.197" DIA
Polyimide
Film Pick &
Place Pad
(-RA only)

-TR
= Tape &
Reel

-FR
= Full Reel
Tape & Reel
(must order
max. quantity
per reel;
contact
Samtec for
quantity
breaks)

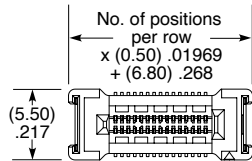

LEAD STYLE	A
-01.0	(3.72) .146
-03.0	(5.72) .225

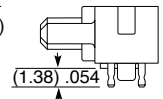
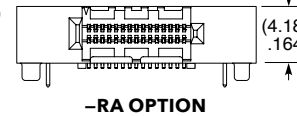
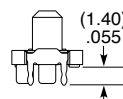
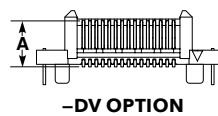
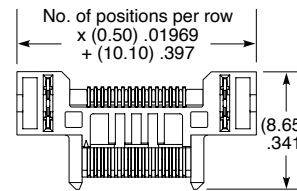

MATED HEIGHT *

FS5 LEAD STYLE	FT5 LEAD STYLE	
	-01.0	-03.0
-04.0	(5.00 mm) .197"	(7.00 mm) .276"

*Processing conditions will affect mated height.

FS5	NO. OF POSITIONS	LEAD STYLE	PLATING OPTION	DV	TH	K	XR
-----	------------------	------------	----------------	----	----	---	----

-15, -30
(Per Row)

-04.0
= 4 mm
Body
Height

-L
= 10 μ"
(0.25 μm)
Gold on
contact,
Matte Tin
on tail

-TH
= Through-hole
weld tab

-K
= (8.25 mm)
.325" DIA
Polyimide
Film Pick &
Place Pad

-TR
= Tape & Reel

-FR
= Full Reel
Tape & Reel
(must order
max. quantity
per reel;
contact
Samtec for
quantity
breaks)

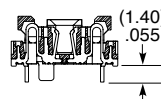
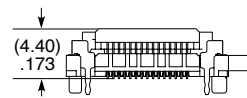
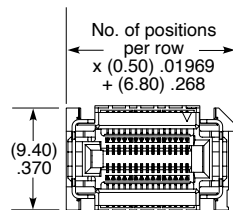

Notes:

Floating contact system provides 0.50 mm float in X and Y directions.

Some lengths, styles and options are non-standard, non-returnable.

BASIC BLADE & BEAM HEADER

(0.50 mm) .0197" PITCH • BTH SERIES

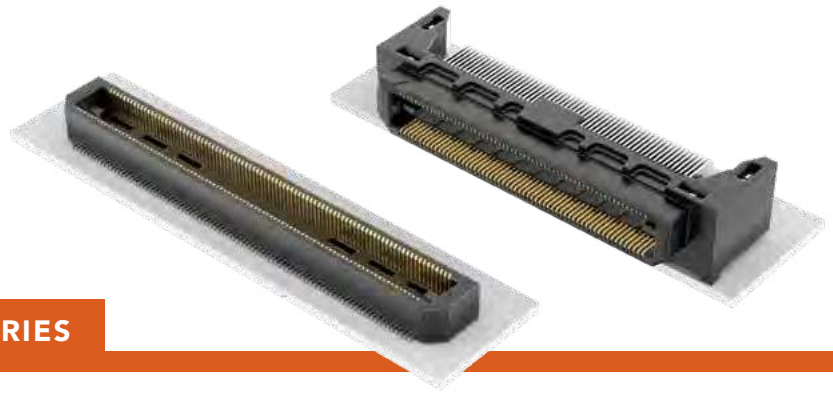

BTH
Mates:
BSH

SPECIFICATIONS

Insulator Material:
Black LCP
Contact Material:
Phosphor Bronze
Plating:
Au or Sn over
50 μ" (1.27 μm) Ni
Current Rating:
2.0 A per pin
(2 pins powered)
Operating Temp Range:
-55 °C to +125 °C
Voltage Rating:
175 VAC
Max Cycles:
100

PROCESSING

Lead-Free Solderable:
Yes
SMT Lead Coplanarity:
Vertical=
(0.10 mm) .004" max (030-090),
(0.15 mm) .006" max (120-150)*
Right-angle=
(0.15 mm) .006" max (030-090)*
*(.004" stencil solution
may be available; contact
ipg@samtec.com)
Board Stacking:
For applications requiring more
than two connectors per board
or 90 positions or higher,
contact ipg@samtec.com

ALSO AVAILABLE

MOQ Required

30 μ" (0.76 μm) Gold
Edge Mount Capability
8 mm, 11 mm, 16 mm,
19 mm and 22 mm Stack
Height (Caution: Some
automatic placement/
inspection machines may
have component height
restrictions. Please consult
machinery specifications.)
(11 mm, 16 mm, 19 mm
and 22 mm not available
with 50 positions)



Note:
Some lengths, styles and
options are non-standard,
non-returnable.

BTH	NO. OF POSITIONS PER ROW	01	PLATING OPTION	D	A	OTHER OPTION
------------	---------------------------------	-----------	-----------------------	----------	----------	---------------------

**-030, -050, -060,
-090, -120, -150**

-F
= Gold Flash
on contact,
Matte Tin on tail

-L
= 10 μ" (0.25 μm)
Gold on contact,
Matte Tin on tail

-C*
= Electro-Polished Selective
50 μ" (1.27 μm) min
Au over 150 μ" (3.81 μm)
Ni on Signal Pins in contact
area, Matte Tin over
50 μ" (1.27 μm) min
Ni on all solder tails
(* -C Plating passes
10 year MFG testing)

-K
= (7.00 mm) .276"
DIA Polyimide
Film Pick
& Place Pad

-TR
= Tape & Reel
(120 positions
maximum)

-FR
= Full Reel
Tape & Reel
(must order
maximum
quantity per reel;
contact
Samtec for
quantity breaks)
(120 positions
maximum)

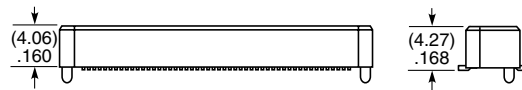
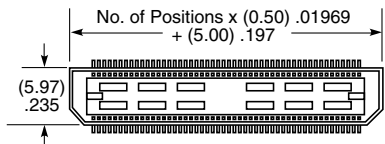

MATED HEIGHT

LEAD STYLE	MATED HEIGHT*
-01	(5.00 mm) .1971"

*Processing conditions
will affect mated height.

BTH	NO. OF POSITIONS PER ROW	01	PLATING OPTION	D	RA	WT	OTHER OPTION
------------	---------------------------------	-----------	-----------------------	----------	-----------	-----------	---------------------

-030, -060, -090

-F
= Gold Flash on
contact, Matte
Tin on tail

-L
= 10 μ" (0.25 μm)
Gold on contact,
Matte Tin on tail

-K
= (7.00 mm)
.276" DIA
Polyimide
Film Pick &
Place Pad

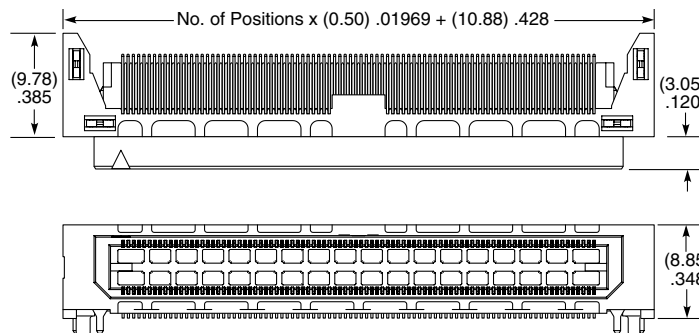

BASIC BLADE & BEAM SOCKET

(0.50 mm) .0197" PITCH • BSH SERIES



BSH
Mates:
BTH

SPECIFICATIONS

Insulator Material:
Black LCP
Contact Material:
Phosphor Bronze
Plating:
Au or Sn over
50 μ" (1.27 μm) Ni
Current Rating:
2 A per pin
(2 pins powered)
Operating Temp Range:
-55 °C to +125 °C
Voltage Rating:
175 VAC
Max Cycles:
100

PROCESSING

Lead-Free Solderable:
Yes
SMT Lead Coplanarity:
(0.10 mm) .004" max (030-090)
(0.15 mm) .006" max (120-150)*
*(.004" stencil solution
may be available; contact
ipg@samtec.com)
Board Stacking:
For applications requiring more
than two connectors per board
or 90 positions or higher,
contact ipg@samtec.com

ALSO AVAILABLE

MOQ Required

30 μ" (0.76 μm) Gold
Edge Mount Capability
8 mm, 11 mm, 16 mm, 19 mm
and 22 mm Stack Height
(Caution: Some automatic
placement/inspection
machines may have
component height
restrictions. Please consult
machinery specifications.)
(11 mm, 16 mm, 19 mm
and 22 mm not available
with 50 positions)



Note:
Some lengths, styles and
options are non-standard,
non-returnable.

BSH	NO. OF POSITIONS PER ROW	01	PLATING OPTION	D	A	OTHER OPTION
------------	---------------------------------	-----------	-----------------------	----------	----------	---------------------

**-030, -050, -060,
-090, -120, -150**

-F
= Gold Flash
on contact,
Matte Tin on tail

-L
= 10 μ" (0.25 μm)
Gold on contact,
Matte Tin on tail

-C*
= Electro-Polished
Selective
50 μ" (1.27 μm) min
Au over 150 μ" (3.81 μm)
Ni on Signal Pins in
contact area,
Matte Tin over
50 μ" (1.27 μm) min
Ni on all solder tails
(*-C Plating passes
10 year MFG testing)

-TR
= Tape & Reel
(120 positions
maximum)

-FR
= Full Reel
Tape & Reel
(must order
maximum
quantity
per reel;
contact
Samtec for
quantity breaks
(120 positions
maximum)

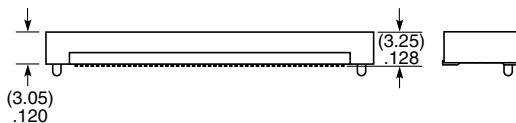
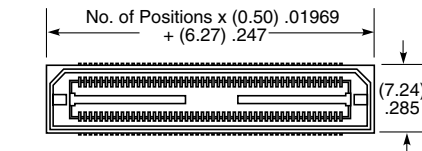

MATED HEIGHT

LEAD STYLE	MATED HEIGHT*
-01	(5.00 mm) .1971"

*Processing conditions
will affect mated height.

BSH	NO. OF POSITIONS PER ROW	01	PLATING OPTION	D	RA	WT	OTHER OPTION
------------	---------------------------------	-----------	-----------------------	----------	-----------	-----------	---------------------

-030, -060, -090

-F
= Gold Flash
on contact,
Matte Tin on tail

-L
= 10 μ" (0.25 μm)
Gold on contact,
Matte Tin on tail

-GP
= Guide
Post

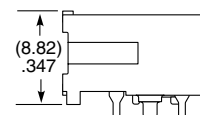
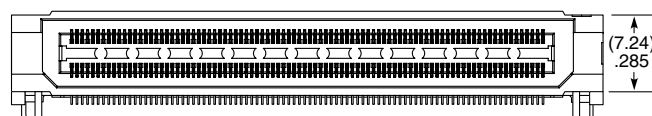
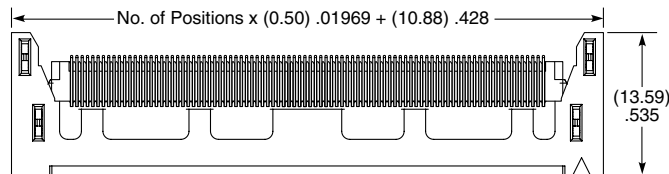

BASIC BLADE & BEAM HEADER & SOCKET

(0.635 mm) .025" PITCH • BTS/BSS SERIES



BTS
Mates:
BSS

BSS
Mates:
BTS

SPECIFICATIONS

Insulator Material:
Liquid Crystal Polymer
Terminal Material:
Phosphor Bronze
Contact Material:
Phosphor Bronze
Plating:
Au or Sn over 50 μ" (1.27 μm) Ni
Current Rating:
1.8 A per pin
(2 pins powered)
Operating Temp Range:
-55 °C to +125 °C

PROCESSING

Lead-Free Solderable:
Yes
SMT Lead Coplanarity:
(0.10 mm) .004" max
Board Stacking:
For applications requiring more than two connectors per board or 100 positions or higher, contact ipg@samtec.com

ALSO AVAILABLE

MOQ Required

30 μ" (0.76 μm) Gold
Other platings
Other positions

MATED HEIGHT

LEAD STYLE	MATED HEIGHT*
-01	(5.00 mm) .197"

*Processing conditions will affect mated height.



Note:
Some lengths, styles and options are non-standard, non-returnable.

BTS	NO. OF POSITIONS PER ROW	01	PLATING OPTION	D	A	OTHER OPTION
------------	---------------------------------	-----------	-----------------------	----------	----------	---------------------

-025, -050,
-075, -100

-F
= Gold Flash on contact,
Matte Tin on tail

-L
= 10 μ" (0.25 μm)
Gold on contact,
Matte Tin on tail

-K
= (7.00 mm)
.275" DIA
Polyimide Film
Pick & Place Pad

-TR
= Tape & Reel
(-100 positions max.)

-FR
= Full Reel
Tape & Reel
(must order max.
quantity per reel;
contact Samtec for
quantity breaks)
(-100 positions max.)

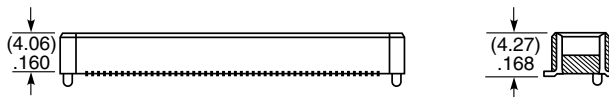
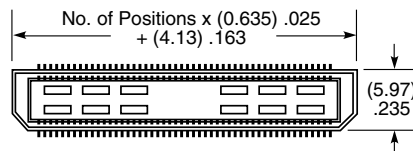

BSS	NO. OF POSITIONS PER ROW	01	PLATING OPTION	D	A	OTHER OPTION
------------	---------------------------------	-----------	-----------------------	----------	----------	---------------------

-025, -050,
-075, -100

-F
= Gold Flash on contact,
Matte Tin on tail

-L
= 10 μ" (0.25 μm)
Gold on contact,
Matte Tin on tail

-TR
= Tape & Reel
(-100 positions maximum)

-FR
= Full Reel
Tape & Reel
(must order maximum
quantity per reel;
contact Samtec for
quantity breaks)
(-100 positions maximum)

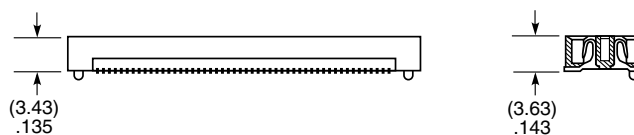
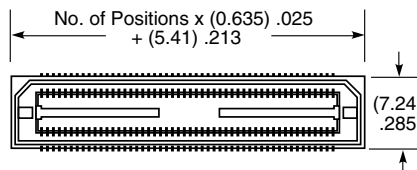

BASIC BLADE & BEAM HEADER & SOCKET

(0.80 mm) .0315" PITCH • BTE/BSE SERIES



BTE
Mates:
BSE

BSE
Mates:
BTE

SPECIFICATIONS

Insulator Material:
Liquid Crystal Polymer
Contact Material:
Phosphor Bronze
Plating:
Au or Sn over 50 μ" (1.27 μm) Ni
Current Rating:
2 A per pin
(2 pins powered)
Operating Temp Range:
-55 °C to +125 °C
Voltage Rating:
225 VAC with 5 mm Stack Height
Max Cycles:
100

PROCESSING

Lead-Free Solderable:
Yes
SMT Lead Coplanarity:
(0.10 mm) .004" max (020-080)
(0.15 mm) .006" max (100-120)*
*(.004" stencil solution may be available; contact ipg@samtec.com)
Board Stacking:
For applications requiring more than two connectors per board or 80 positions or higher, contact ipg@samtec.com

ALSO AVAILABLE

MOQ Required

30 μ" (0.76 μm) Gold
Edge Mount Capability
Friction Lock option
11 mm, 14 mm, 16.10 mm, 19.10 mm, 22 mm, 25 mm and 30 mm Stack Height (Caution: Some automatic placement/inspection machines may have component height restrictions. Please consult machinery specifications.)



Note:
Some lengths, styles and options are non-standard, non-returnable.

BTE	NO. OF POSITIONS PER ROW	LEAD STYLE	PLATING OPTION	D	A	OTHER OPTION
------------	---------------------------------	-------------------	-----------------------	----------	----------	---------------------

-020, -040, -060,
-080, -100, -120

Specify
LEAD
STYLE
from
chart

-F
= Gold Flash on contact,
Matte Tin on tail

-L
= 10 μ" (0.25 μm)
Gold on contact,
Matte Tin on tail

-C*
= Electro-Polished Selective
50 μ" (1.27 μm) min
Au over 150 μ" (3.81 μm)
Ni on Signal Pins in contact
area, Matte Tin over
50 μ" (1.27 μm) min
Ni on all solder tails
(*-C Plating passes
10 year MFG testing)

-K
= (7.00 mm)
.275" DIA
Polyimide Film
Pick & Place Pad

-TR
= Tape & Reel
(80 positions
maximum)

-FR
= Full Reel
Tape & Reel
(must order
maximum
quantity per
reel; contact
Samtec for
quantity breaks)
(80 positions
maximum)

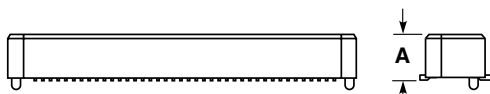
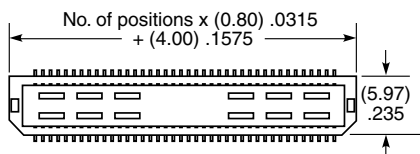

LEAD STYLE	A
-01	(4.27) .168
-02	(7.21) .284

MATED HEIGHT

LEAD STYLE	MATED HEIGHT*
-01	(5.00 mm) .1971"
-02	(8.00 mm) .315"

*Processing conditions will affect mated height.

BSE	NO. OF POSITIONS PER ROW	01	PLATING OPTION	D	A	OTHER OPTION
------------	---------------------------------	-----------	-----------------------	----------	----------	---------------------

-020, -040, -060,
-080, -100, -120

-F
= Gold Flash on contact,
Matte Tin on tail

-L
= 10 μ" (0.25 μm)
Gold on contact,
Matte Tin on tail

-C*
= Electro-Polished Selective
50 μ" (1.27 μm) min
Au over 150 μ" (3.81 μm)
Ni on Signal Pins in contact
area, Matte Tin over
50 μ" (1.27 μm) min
Ni on all solder tails
(*-C Plating passes
10 year MFG testing)

-TR
= Tape & Reel
(80 positions
maximum)

-FR
= Full Reel
Tape & Reel
(must order
maximum
quantity per
reel; contact
Samtec for
quantity breaks)
(80 positions
maximum)

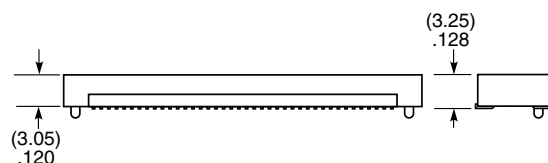
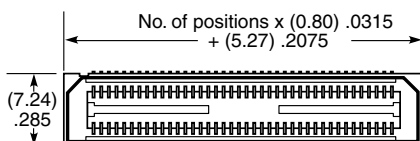

SMT MICRO HEADER & SOCKET

(0.80 mm) .0315" PITCH • FTE/CLE SERIES



FTE
Mates:
CLE

CLE
Mates:
FTE, AW

SPECIFICATIONS

Insulator Material:
Black Liquid Crystal Polymer
Terminal Material:
Phosphor Bronze
Contact Material:
BeCu
Plating:
Au over 50 μ" (1.27 μm) Ni
Current Rating (FTE/CLE):
2.7 A per pin
(2 pins powered)
Operating Temp Range:
-55 °C to +125 °C
Insertion Depth (CLE):
Top Entry =
(1.73 mm) .068" to (3.18 mm) .125"
with (0.38 mm) .015"
wipe, or pass-through
Bottom Entry =
(3.23 mm) .127" minimum plus
board thickness
Max Cycles (CLE):
100 with 10 μ" (0.25 μm) Au

PROCESSING

Lead-Free Solderable:
Yes
SMT Lead Coplanarity (FTE):
-DV: (0.10 mm) .004" max
-DH: (0.10 mm) .004" max (05-25)
(0.15 mm) .006" max (26-50)*
*(.004" stencil solution
may be available; contact
ipg@samtec.com)
SMT Lead Coplanarity (CLE):
(0.10 mm) .004" max (04-65)
(0.15 mm) .006" max (66-90)*
*(.004" stencil solution
may be available; contact
ipg@samtec.com)



05
thru
90

Specify
LEAD
STYLE
from
chart

-G
= 10 μ"
(0.25 μm)
Gold on
post,
Gold flash
on balance

-DV
= Dual
Vertical
-DH
= Dual
Horizontal
(50 positions
maximum)

Style -01 -DV only
(11 pins/row
minimum)
-ES
= End Shroud
-EC
= End Shroud with
Locking Clips
(Manual placement
required)
-EP
= End Shroud with
Guide Posts

-A
= Alignment
Pin
(5 positions
minimum)
Metal or
plastic at
Samtec
discretion
(-DV only)
-K
= (2.50 mm)
.098" DIA
Polyimide
Film Pick &
Place Pad
(-DH only)

-P
= Plastic Pick
& Place Pad
(8 positions
minimum)
-DV only

-TR
= Tape & Reel

-FR
= Full Reel
Tape & Reel
(must order
max. quantity
per reel;
contact
Samtec for
quantity
breaks)

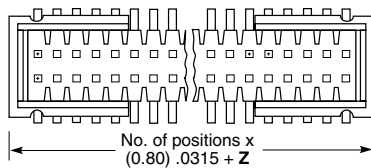
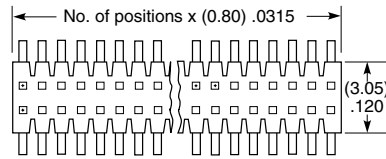

OPTION	Z	LEAD STYLE	A
-ES	(1.57) .062	-01	(1.90) .075
-EC	(4.11) .162	-02	(4.45) .175
-EP	(5.51) .217	-03	(3.05) .120

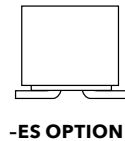
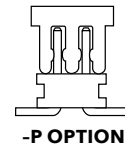
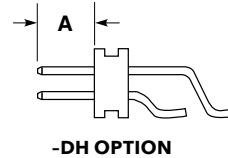
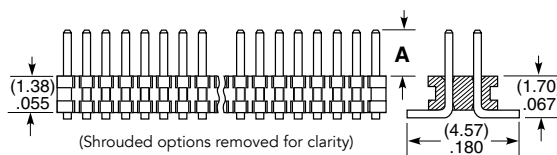

04 thru 90

-G
= 10 μ"
(0.25 μm)
Gold

-A
= Alignment Pin
(4 positions minimum)
Metal or plastic at
Samtec discretion.
-K
= (3.50 mm) .138" DIA
Polyimide film
Pick & Place Pad
(8 positions minimum)

-P
= Metal Pick & Place Pad
(8 positions minimum)

-TR
= Tape & Reel

-FR
= Full Reel Tape & Reel
(must order max. quantity
per reel; contact Samtec
for quantity breaks)

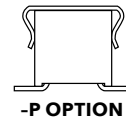
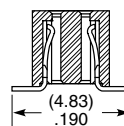
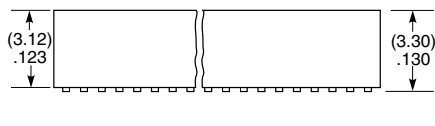
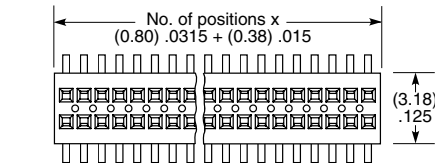

Note:
Some lengths, styles and
options are non-standard,
non-returnable.

SMT MICRO BOARD STACKER

(0.80 mm) .0315" PITCH • AW SERIES

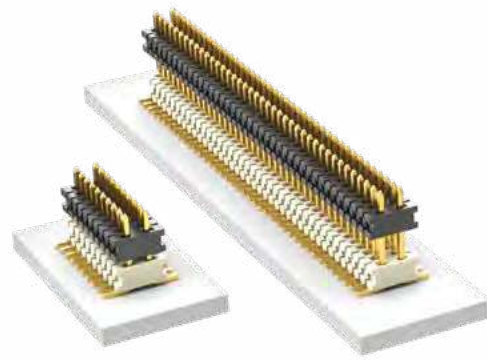

AW

Mates:
CLE

SPECIFICATIONS

Insulator Material:

Top: Black LCP
Bottom: Natural LCP

Terminal Material:

Phosphor Bronze

Plating:

Au over 50 μ " (1.27 μ m) Ni

Operating Temp Range:

-55 °C to +125 °C

PROCESSING

Lead-Free Solderable:

Yes

SMT Lead Coplanarity:

(0.10 mm) .004" max (05-40)

(0.15 mm) .006" max (41-90)*

*(.004" stencil solution

may be available; contact

ipg@samtec.com)

OPTIONS

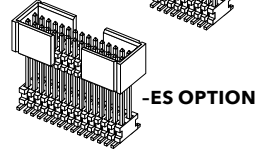
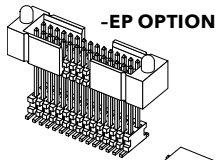

Notes:

For added mechanical stability, Samtec recommends mechanical board spacers be used in applications with gold or selective gold plated connectors. Contact ipg@samtec.com for more information.

Some lengths, styles and options are non-standard, non-returnable.

AW	NO. PINS PER ROW	03	PLATING OPTION	D	STACKER HEIGHT	POST HEIGHT	OTHER OPTION
----	------------------	----	----------------	---	----------------	-------------	--------------

05 thru 90

-G
= 10 μ "
(0.25 μ m)
Gold

-"XXX"
= Stacker Height
(in inches)
(3.09 mm)
.122" to
(5.84 mm)
.230"

Example:
-175
= (4.45 mm)
.175"

-"XXX"
= Post Height
(in inches)
(1.91 mm)
.075"
minimum

Example:
-075
= (1.91 mm)
.075"

-ES
= End Shroud
11 pins/row min.
(-075 Post Height only)

-EP
= End Shroud with Guide Post
(-075 Post Height only)
11 pins/row min.

-A
= Alignment Pin
(4 positions min.)
(Available for board stacks between
(4.06 mm) .160" to
(5.84 mm) .230")
(Metal or plastic at Samtec discretion.)

-P
= Pick & Place Pad
(8 positions min.)

-TR
= Tape & Reel
(84 positions max.)

-FR
= Full Reel
Tape & Reel
(must order max. quantity per reel; contact Samtec for quantity breaks)
(84 positions max.)

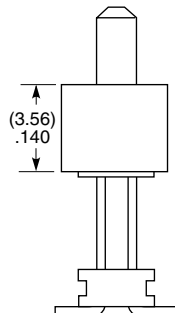
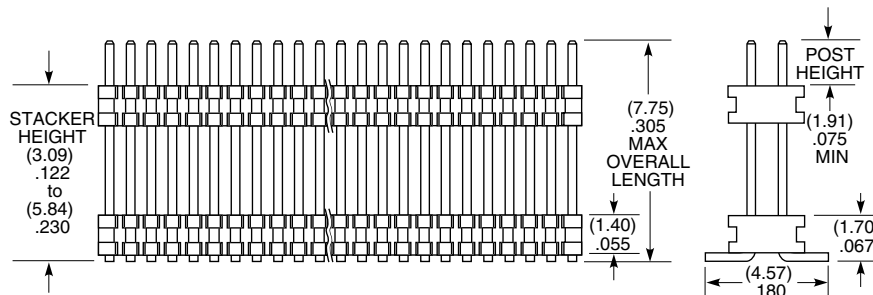
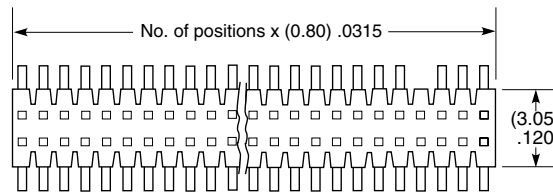

-EP OPTION

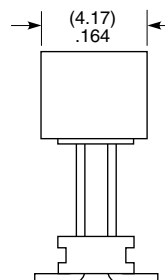

-ES OPTION

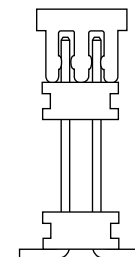

-P OPTION

SMT MICRO TERMINAL STRIPS

(1.00 mm) .0394" PITCH • FTMH/FTM SERIES

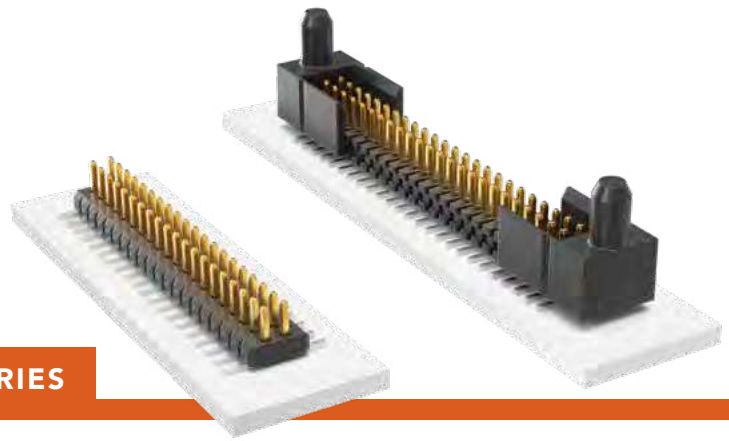

FTMH
Mates:
CLM, MLE

FTM
Mates:
CLM, MLE

FTMH	1	NO. PINS PER ROW	LEAD STYLE	PLATING OPTION	ROW OPTION	FLEX SHROUD OPTION	OTHER OPTION
------	---	------------------	------------	----------------	------------	--------------------	--------------

05
thru
50

-02
= (1.91 mm)
.075" Post
(Mates with MLE)

-F
= Gold flash
on post,
Matte Tin
on tail

-DV
= Dual
Vertical

(-DV only with
9 pins/row
minimum)

-A
= Alignment Pin
(3 positions min.)
Metal or plastic at
Samtec discretion
(-DV only)

-ES
= End Shroud

-DH
= Dual
Horizontal

-EC
= End Shroud
with Locking Clip
(Manual placement
required)

-K
= (2.50 mm)
.098" DIA
Polyimide Film
Pick & Place Pad
(-DH only)

-EP
= End Shroud
with Guide Post
(Use only when
mating with CLM)

-P
= Plastic Pick
& Place Pad
(6 positions min.)
(-DV only)

-TR
= Tape & Reel

-FR
= Full Reel
Tape & Reel
(must order max.
quantity per reel;
contact Samtec for
quantity breaks)

SPECIFICATIONS

Insulator Material:
Black Liquid Crystal
Polymer
Terminal Material:
Phosphor Bronze
Plating:
Sn or Au over
50 μ" (1.27 μm) Ni
Current Rating (FTMH/CLM):
3.1 A per pin
(2 pins powered)
Operating Temp Range:
-55 °C to +125 °C
Voltage Rating:
FTMH: 270 VAC

PROCESSING

Lead-Free Solderable:
Yes
SMT Lead Coplanarity:
-DV: (0.10 mm) .004" max
-DH: (0.10 mm) .004" max (05-25)
(0.15 mm) .006" max (26-50)*
*(.004" stencil solution
may be available; contact
ipg@samtec.com)

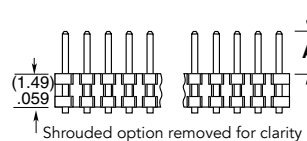
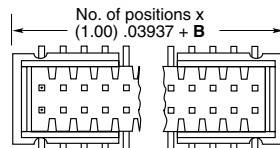
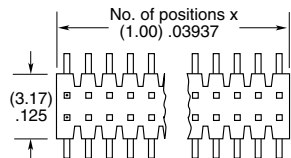

OPTION	B
-ES	(1.57) .062
-EC	(4.06) .160
-EP	(5.49) .216

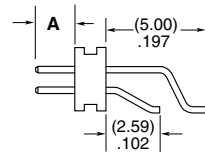
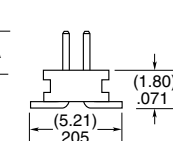

LEAD STYLE	A
-02	(1.91) .075
-03	(1.65) .065

FTM	1	NO. PINS PER ROW	LEAD STYLE	PLATING OPTION	DV	FLEX SHROUD OPTION	OTHER OPTION
-----	---	------------------	------------	----------------	----	--------------------	--------------

02 thru 50
= Unshrouded
05 thru 46
= Shrouded

-02
= (1.91 mm)
.075" Post
(Mates with MLE)

-F
= Gold flash
on post,
Matte Tin
on tail

-S
= End Shroud
(05 positions
minimum).
Molded or
press-fit shroud
at Samtec's
discretion

-P
= Plastic Pick
& Place Pad
(7 positions min.)

-TR
= Tape & Reel

-FR
= Full Reel
Tape & Reel
(must order max.
quantity per reel;
contact Samtec for
quantity breaks)

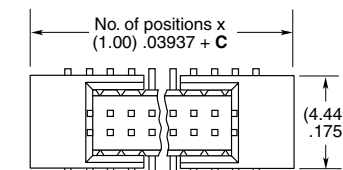
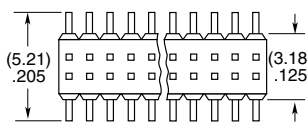

OPTION	C
-S	(4.00) .157
-SA	(7.00) .276

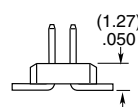
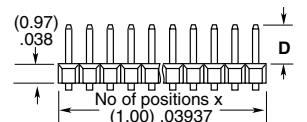

LEAD STYLE	D
-02	(1.91) .075
-03	(1.65) .065

ALSO AVAILABLE

MOQ Required

End shrouds with board locks
Molded end shrouds for
05 through 08 positions
Other platings



Note:
Some lengths, styles and
options are non-standard,
non-returnable.

FLEX STACK

SMT MICRO BOARD HEADER

(1.00 mm) .0394" PITCH • MW SERIES

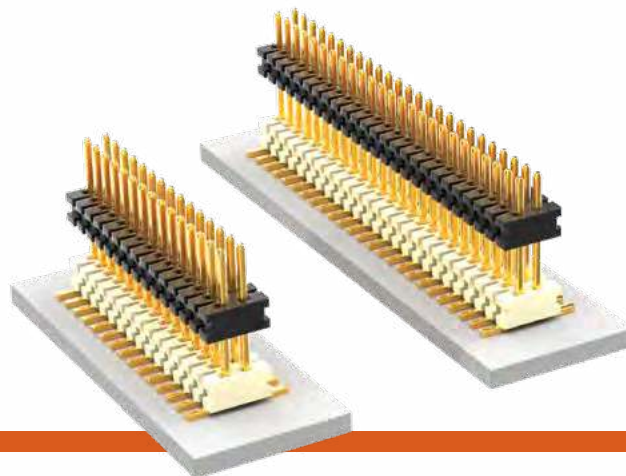

MW

Mates:

CLM, MLE

SPECIFICATIONS

Insulator Material:

Top: Black LCP
Bottom: Natural LCP

Terminal Material:

Phosphor Bronze

Plating:

Au over 50 μ" (1.27 μm) Ni

Operating Temp Range:

-55 °C to +125 °C

PROCESSING

Lead-Free Solderable:

Yes

SMT Lead Coplanarity:

(0.10 mm) .004" max (02-30)

(0.15 mm) .006" max (31-50)*

*(.004" stencil solution

may be available; contact

ipg@samtec.com)

MW	-	NO. PINS PER ROW	-	03	-	PLATING OPTION	-	D	-	STACKER HEIGHT	-	POST HEIGHT	-	OPTION
-----------	----------	-------------------------	----------	-----------	----------	-----------------------	----------	----------	----------	-----------------------	----------	--------------------	----------	---------------

02 thru 50

-G
= 10 μ"
(0.25 μm)
Gold

-"XXX"
= Stacker
Height
(in inches)

(2.41 mm)
.095" to
(6.22 mm)
.245"

Example:
-245
= (6.22 mm)
.245"

-"XXX"
= Post
Height
(in inches)

(1.65 mm)
.065"
minimum

Example:
-065
= (1.65 mm)
.065"

-A
= Alignment
Pin
(5 positions
minimum)
Metal or
plastic at
Samtec's
discretion

-P
= Pick &
Place Pad
(7 positions
minimum)

-TR
= Tape & Reel

-FR
= Full Reel
Tape & Reel
(must order
maximum
quantity per
reel; contact
Samtec for
quantity
breaks)

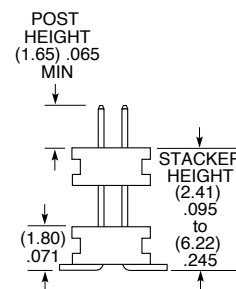
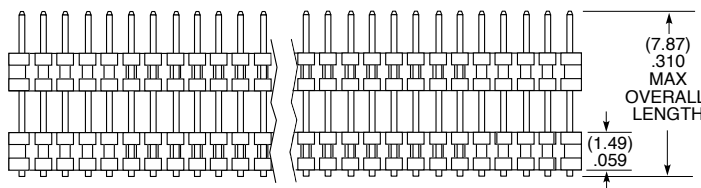
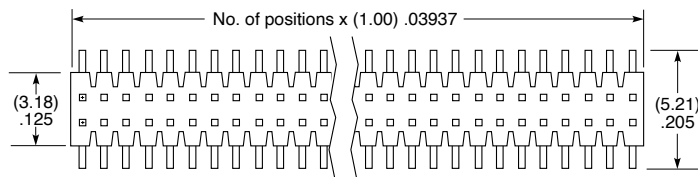

ALSO AVAILABLE

MOQ Required

End shrouds

End shrouds with
guide posts

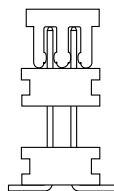
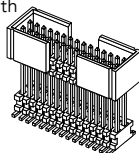

-P OPTION

Notes:

For added mechanical stability, Samtec recommends mechanical board spacers be used in applications with gold or selective gold plated connectors. Contact ipg@samtec.com for more information.

This Series is non-standard, non-returnable.

APPLICATION

EXAMPLES		
LEAD STYLE		MATED HEIGHT*
MW	CLM	
-163-065	-02	(6.35 mm) .250"
-233-065		(8.13 mm) .320"

*Processing conditions will affect mated height.

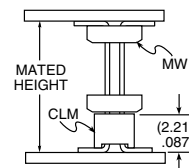

RUGGED RELIABLE MICRO SOCKETS

(1.00 mm) .0394" PITCH • CLM/MLE SERIES

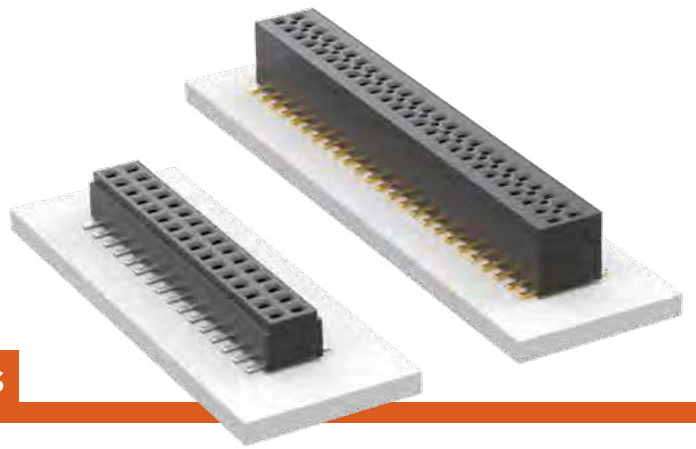

CLM

Mates:
FTM, FTMH, MW

MLE

Mates:
FTM, FTMH, MW

SPECIFICATIONS

Insulator Material: Black LCP
Contact Material:
 CLM: Phosphor Bronze
 MLE: BeCu
Plating:
 CLM: Au or Sn over
 50 μ " (1.27 μ m) Ni
 MLE: Au over 10 μ " (0.25 μ m) Ni
Current Rating (CLM/FTM):
 3.1 A per pin
 (2 pins powered)
Current Rating (MLE/FTM):
 2.9 A per pin (2 pins powered)
Operating Temp Range:
 -55 °C to +125 °C
Max Cycles:
 CLM: 100 with 10 μ " (0.25 μ m) Au
Voltage Rating:
 CLM: 270 VAC
 MLE: 310 VAC
Insertion Depth:
 CLM:
 Top Entry = (1.40 mm) .055" min.,
 Bottom Entry =
 (2.41 mm) .095" min.
 (Add board thickness for
 correct post OAL)
 MLE:
 (1.63 mm) .064" to
 (3.18 mm) .125" with
 (0.38 mm) .015" wipe,
 pass-through, or (2.44 mm) .096"
 minimum for bottom entry

PROCESSING

Lead-Free Solderable:
 Yes
SMT Lead Coplanarity:
 (0.10 mm) .004" max (02-25)
 (0.15 mm) .006" max (26-50)*
 *(.004" stencil solution
 may be available; contact
 ipg@samtec.com)

ALSO AVAILABLE

MOQ Required

Alignment pin
 Other Gold plating options



Note:
 Some lengths, styles and
 options are non-standard,
 non-returnable.



02 thru 50

-F
 = Gold flash on
 contact,
 Matte Tin on tail

-L
 = 10 μ " (0.25 μ m)
 Gold on contact,
 Matte Tin on tail

-BE
 = Bottom Entry
 (Required for bottom entry)

-K
 = (3.50 mm) .138" DIA
 Polyimide film
 Pick & Place Pad
 (7 positions minimum)

-P
 = Pick & Place Pad
 (7 positions minimum)

-PA
 = Pick & Place Pad with
 integral Alignment Pin

-TR
 = Tape & Reel

-FR
 = Full Reel Tape & Reel
 (must order maximum
 quantity per reel;
 contact Samtec for
 quantity breaks)

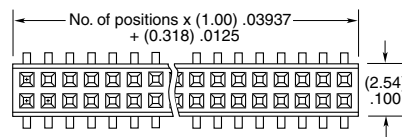

PIN/ROW	A
04-15	(3.56) .140
16-50	(7.11) .280

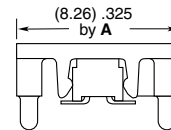

-PA

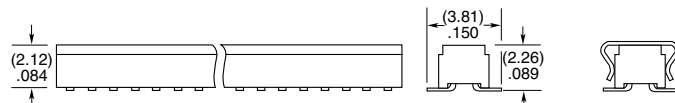

-P



02 thru 50

-G
 = 10 μ "
 (0.25 μ m)
 Gold

-A
 = Alignment Pin
 (3 positions minimum)
 Metal or plastic
 at Samtec discretion

-K
 = (4.00 mm) .1575" DIA
 Polyimide film
 Pick & Place Pad
 (5 positions minimum)

-P
 = Metal Pick & Place Pad
 (5 positions minimum)

-TR
 = Tape & Reel

-FR
 = Full Reel Tape & Reel
 (must order maximum
 quantity per reel;
 contact Samtec for
 quantity breaks)

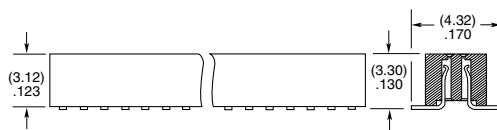
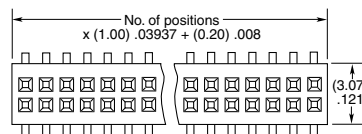

-P

-A

QUAD ROW SMT TERMINAL & SOCKET

(1.27 mm) .050" PITCH • TOLC/SOLC SERIES



TOLC
Mates:
SOLC

SOLC
Mates:
TOLC

SPECIFICATIONS

Insulator Material:
Black Liquid Crystal Polymer
Contact Material:
Phosphor Bronze
Plating:
Au over 50 μ" (1.27 μm) Ni
Current Rating:
2.4 A per pin
(6 adjacent pins powered)
Operating Temp Range:
-55 °C to +125 °C
Insertion Depth (SOLC):
(1.68 mm) .066" to
(3.61 mm) .142" with
(0.38 mm) .015" wipe
Max Cycles (SOLC):
100+

PROCESSING

Lead-Free Solderable:
Yes
SMT Lead Coplanarity:
(0.10 mm) .004" max (05-35)
(0.15 mm) .006" max (40-50)*
*(.004" stencil solution
may be available; contact
ipg@samtec.com)

TOLC	1	NO. PINS PER ROW	LEAD STYLE	PLATING OPTION	Q	OTHER OPTION
-------------	----------	-------------------------	-------------------	-----------------------	----------	---------------------

05, 10, 15, 20, 25,
30, 35, 40, 45, 50
(Standard Sizes)

Specify
LEAD
STYLE
from
chart

-F
= Gold flash
on contact,
Gold flash
on tail
-L
= 10 μ"
(0.25 μm)
Gold on
contact,
Gold flash
on tail

-A
= Alignment Pin
(N/A with -LC)
-LC
= Locking Clip
(N/A with -A)
(Manual
placement required)
-K
= (9.00 mm) .354" DIA
Polyimide film
Pick & Place Pad

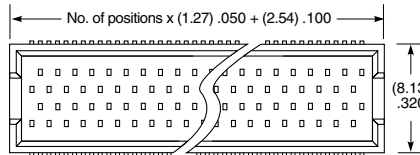

LEAD STYLE	A	MATED HEIGHT
-02	(5.59) .220	(6.35) .250
-12	(7.24) .285	(8.00) .315
-22	(9.25) .364	(10.00) .394
-32	(11.23) .442	(12.00) .472

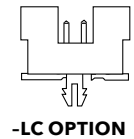
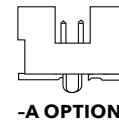
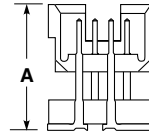
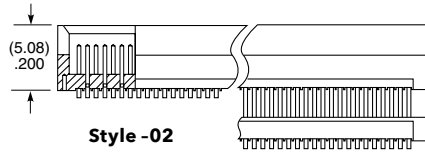

SOLC	1	NO. PINS PER ROW	02	PLATING OPTION	Q	OTHER OPTION
-------------	----------	-------------------------	-----------	-----------------------	----------	---------------------

05, 10, 15, 20, 25,
30, 35, 40, 45, 50
(Standard Sizes)

-F
= Gold flash
on contact,
Gold flash
on tail
-L
= 10 μ" (0.25 μm)
Gold on contact,
Gold flash
on tail

-A
= Alignment Pin
(N/A with -LC)
-LC
= Locking Clip
(N/A with -A)
(Manual
placement required)
-K
= (7.00 mm) .276" DIA
Polyimide film
Pick & Place Pad
-P
= Pick & Place Pad
-TR
= Tape & Reel
-FR
= Full Reel Tape & Reel
(must order max.
quantity per reel;
contact Samtec for
quantity breaks)

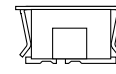
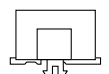
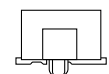
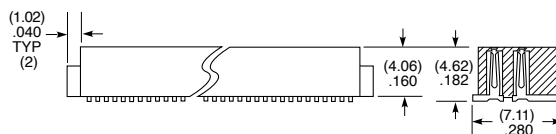
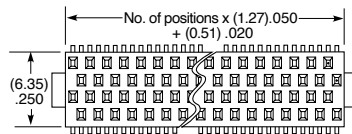

ALSO AVAILABLE

MOQ Required

Other sizes
Other platings

Note:
Some lengths, styles and
options are non-standard,
non-returnable.

SURFACE MOUNT MICRO HEADER

(1.27 mm) .050" PITCH • FTSH SERIES

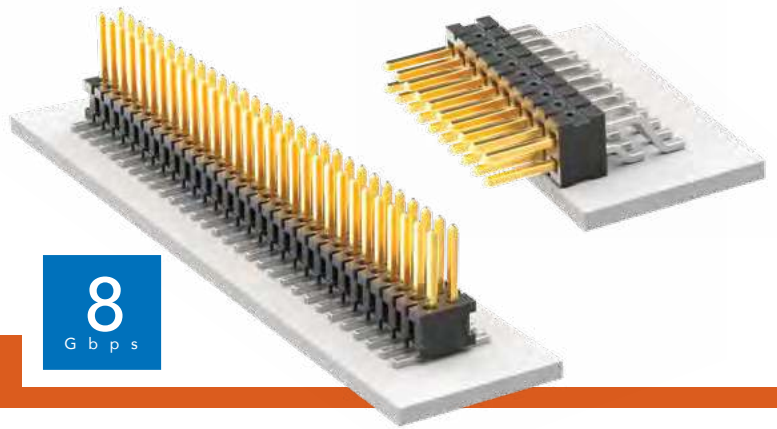

FTSH

Board Mates:

CLP, FLE

Cable Mates:

FFSD, FFTP

SPECIFICATIONS

Insulator Material:

Black Liquid Crystal Polymer

Terminal Material:

Phosphor Bronze

Plating:

Sn or Au over

50 μ" (1.27 μm) Ni

Current Rating (FTSH/CLP):

3.4 A per pin

(2 pins powered)

Operating Temp Range:

-55 °C to +125 °C

PROCESSING

Lead-Free Solderable:

Yes

SMT Lead Coplanarity:

-MT & -DV Tail Option:

(0.10 mm) .004" max (02-25)

-MT & -DH Tail Option:

(0.15 mm) .006" max (26-50)*

*(.004" stencil solution

may be available; contact

ipg@samtec.com)

ALSO AVAILABLE

MOQ Required

Molded Pick & Place pads

Latches

Other platings



Notes:

Severe Environment Testing qualified; aligns with MIL-DTL-55302. Visit samtec.com/set

Some sizes, styles and options are non-standard, non-returnable.

See SFM/TFM for positive alignment feature.

FTSH	1	NO. PINS PER ROW	LEAD STYLE	PLATING OPTION	TAIL OPTION	OPTION	FLEX SHROUD OPTIONS	OTHER OPTIONS
------	---	------------------	------------	----------------	-------------	--------	---------------------	---------------

02 thru 50

-01
= (3.05 mm) .120" Post (Mates with FFSD)

-02
= (1.91 mm) .075" Post (Mates with FLE)

-03
= (1.65 mm) .065" Post (Mates with CLP-D)

-04
= (3.81 mm) .150" Post (Mates with CLP-DH)

-05
= (4.32 mm) .170" Post (Mates with CLP-BE)

-F
= Gold flash on post, Matte Tin on tail

-L
= 10 μ" (0.25 μm) Gold on post, Matte Tin on tail

-DV
= Double Vertical

-DH
= Double Horizontal (Styles -01, -02 & -04 only)

-MT
= Mixed Technology (Styles -01, -02 & -04 only)

Leave Blank for -DH & -MT

-"XXX"
= Polarized Position (Specify position of omitted pin) (Not available with -EX options)

(Style -02 & -03 only, -DH & -MT not available) 9 pins/row minimum (Other positions available. Call Samtec.)

-ES
= End Shroud

-EC
= End Shroud with Locking Clip (Manual placement required)

-EP
= End Shroud with Guide Post

-EL
= End Shroud with Board Lock (Boards are positively locked and cannot be unmated)

-EJ
= Ejector Shroud (Style -01 only) -DH & -MT not available 10 pins/row minimum 25 pins/row maximum

-K
= Keying Shroud for mating with FFSD (Style -01 only, 05 thru 25 pins/row only. 13, 17, 20 & 25 only with -EJ option) (-DV only)

-A
= Alignment Pin (-DV 3 positions minimum) (-DH 5 positions minimum) (Metal or plastic at Samtec discretion)

-C
= (5.00 mm) .197" DIA Polyimide film Pick & Place Pad (-DH only)

-P
= Pick & Place Pad (-DV 4 positions minimum) (-DH & -MT not available)

-TR
= Tape & Reel (Flex Shroud options not available except -ES & -EJ)

-FR
= Full Reel Tape & Reel (must order maximum quantity per reel; contact Samtec for quantity breaks)

OPTION	Z
-ES	(2.57) .101
-EJ	(15.77) .621
-EC	(3.33) .131
-EP	(5.87) .231
-EL	(6.53) .257

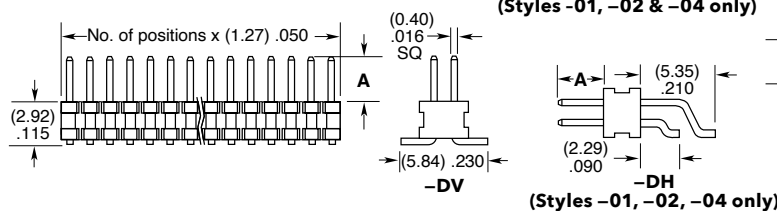
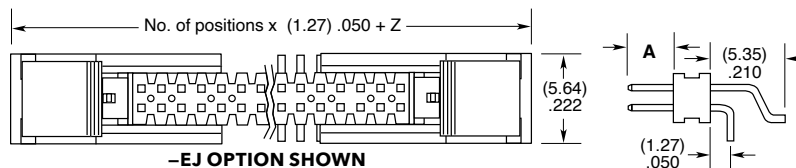
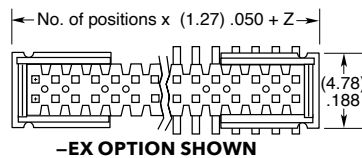

LEAD STYLE	A
-01	(3.05) .120
-02	(1.91) .075
-03	(1.65) .065
-04	(3.81) .150
-05	(4.32) .170

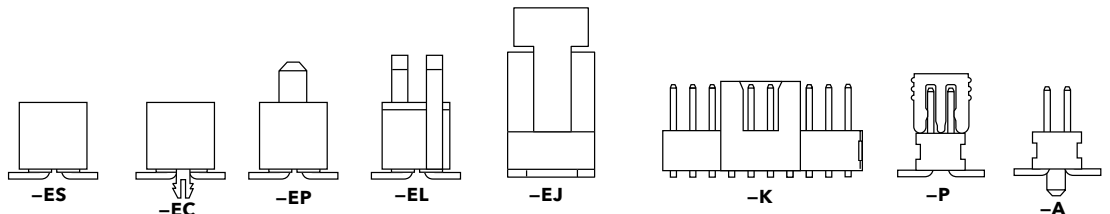

THROUGH-HOLE MICRO HEADER

(1.27 mm) .050" PITCH • FTSH SERIES

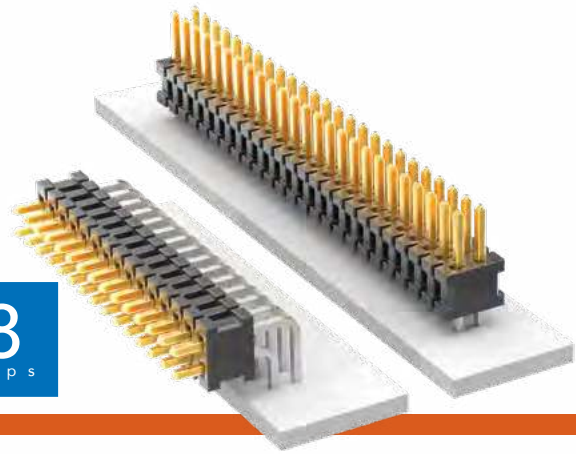

FTSH

Board Mates:
CLP, FLE

Cable Mates:
FFSD, FFTP

SPECIFICATIONS

Insulator Material:
Black Liquid Crystal Polymer
Terminal Material:
Phosphor Bronze
Plating:
Sn or Au over 50 μ" (1.27 μm) Ni
Current Rating (FTSH/CLP):
3.4 A per pin
(2 pins powered)
Operating Temp Range:
-55 °C to +125 °C

PROCESSING

Lead-Free Solderable:
Yes

LOCKING CLIP

For single mating cycle with the FFSD. Specify -LC after tail option. Lead Style -01 and 10 pins/row minimum. 5-9 pins/row not available in combination with keying shroud (-K).

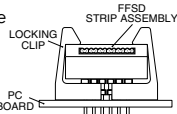

FTSH	1	NO. PINS PER ROW	LEAD STYLE	PLATING OPTION	D	OPTION	TAIL OPTION	OTHER OPTIONS
------	---	------------------	------------	----------------	---	--------	-------------	---------------

02 thru 50

Specify LEAD STYLE from chart

-F
= Gold flash on post, Matte Tin on tail
-L
= 10 μ" (0.25 μm) Gold on post, Matte Tin on tail

Leave blank for Right-angle
-"XXX"
= Polarized Position (Specify position of omitted pin) (Not available with -EX options)

Leave blank for straight tail
-RA
= Right-angle

-ES
= End Shroud (Style -02 & -03) 9 pins/row minimum

-EP
= End Shroud with Guide Post (Style -02 & -03) 9 pins/row minimum

-EL
= End Shroud with Board Lock (Style -02 & -03) 9 pins/row minimum

-EJ
= Ejector Shroud (Style -01 only) 10 pins/row minimum 25 pins/row maximum -RA not available

-K
= Keying Shroud for mating with FFSD (Style -01 only, 05 thru 25 pins/row only. 13, 17, 20 & 25 only with -EJ option)

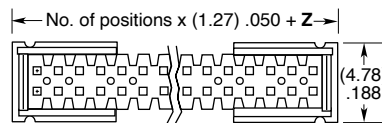

-EX OPTION SHOWN

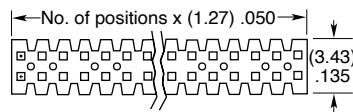

OPTION	Z
-ES	(1.55) .061
-EJ	(15.77) .621
-EP	(5.87) .231
-EL	((6.53) .257

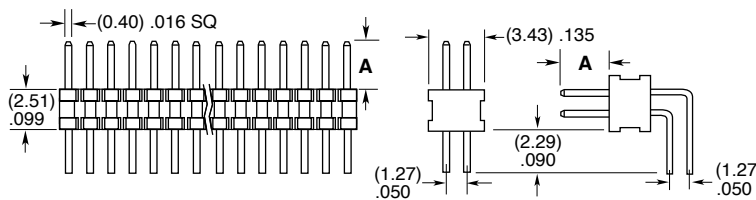

LEAD STYLE	A	MATES WITH
-01	(3.05) .120	FFSD
-02	(1.91) .075	FLE
-03	(1.65) .065	CLP-D
-04	(3.81) .150	N/A

ALSO AVAILABLE

MOQ Required

Molded Pick & Place pads
Other platings



Notes:
Severe Environment Testing qualified; aligns with MIL-DTL-55302. Visit samtec.com/set

Some sizes, styles and options are non-standard, non-returnable.

See SFM/TFM for positive alignment feature.

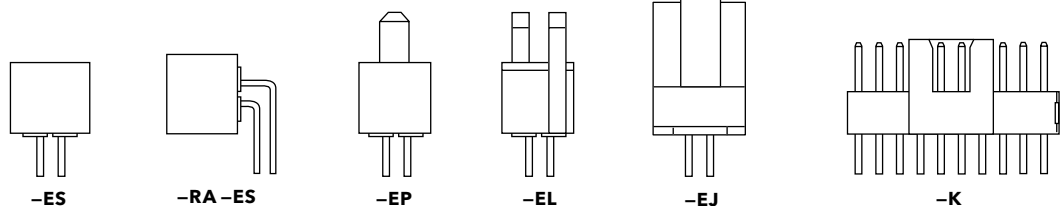

MICRO LOW PROFILE TERMINAL STRIPS

(1.27 mm) .050" PITCH • FTS SERIES

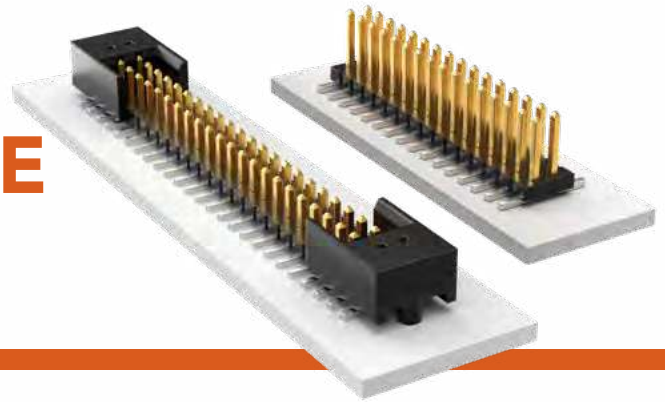

FTS

Board Mates:
CLP, FLE

Cable Mates:
FFSD

SPECIFICATIONS

Insulator Material:
Black Liquid Crystal Polymer
Terminal Material:
Phosphor Bronze
Operating Temp Range:
-55 °C to +125 °C
Plating:
Sn or Au over 50 μ" (1.27 μm) Ni
Current Rating:
3.4 A per pin
(2 pins powered)

PROCESSING

Lead-Free Solderable:
Yes
SMT Lead Coplanarity:
.004" (0.10 mm) max

ALSO AVAILABLE

Alignment pin
(MOQ Required)

OPTIONS

-TR OPTION

-SA OPTION

-P OPTION

-S OPTION

FTS	1	NO. PINS PER ROW	LEAD STYLE	PLATING OPTION	ROW OPTION	OTHER OPTION
------------	----------	-------------------------	-------------------	-----------------------	-------------------	---------------------

02 thru 50
(except -S & -SA
option = 05 thru 46)

-01
= (3.05 mm)
.120" Post
(Mates with FFSD)

-02
= (1.91 mm)
.075" Post
(Mates with FLE)

-03
= (1.65 mm)
.065" Post
(Mates with CLP)

-04
= (3.81 mm)
.150" Post
(-D & -DV only)

-F
= Gold flash
on post,
Matte Tin
on tail

-L
= 10 μ"
(0.25 μm)
Gold on post,
Matte Tin
on tail

-D
= Double
Through-hole

-DV
= Double
Vertical SMT

-S
= Single
Through-hole

-SV
= Single
Vertical SMT

(-D & -DV only)

-SA
= End Shroud
with Alignment Pin
(05 thru 46 positions.
Style -02 & -03 only)

-S
= End Shroud
(05 thru 46 positions.
Style -02 & -03 only)

-P
= Pick & Place Pad
(04 positions min.)

-TR
= Tape & Reel
(-DV only)
(Required callout for
positions 02 thru 04)

-FR
= Full Reel
Tape & Reel
(must order max.
quantity per reel;
contact Samtec for
quantity breaks)
(-DV only)

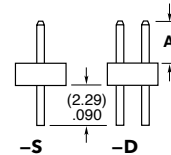
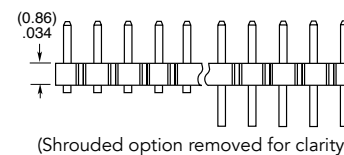
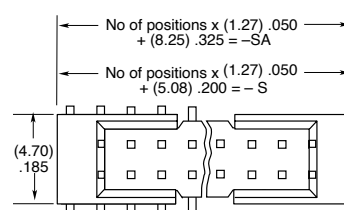
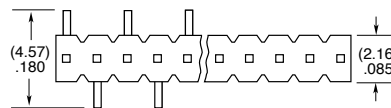
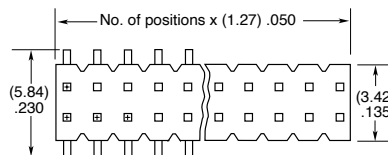

LEAD STYLE	A
-01	(3.05) .120
-02	(1.91) .075
-03	(1.65) .065
-04	(3.81) .150

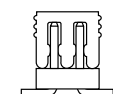
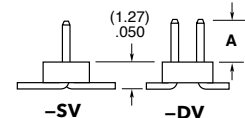

-P OPTION

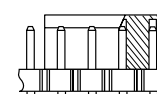

-S OPTION

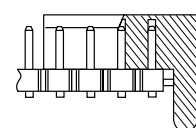

-SA OPTION

Note:
Some lengths, styles and
options are non-standard,
non-returnable.

FLEX STACK

MICRO BOARD STACKER

(1.27 mm) .050" PITCH • FW SERIES

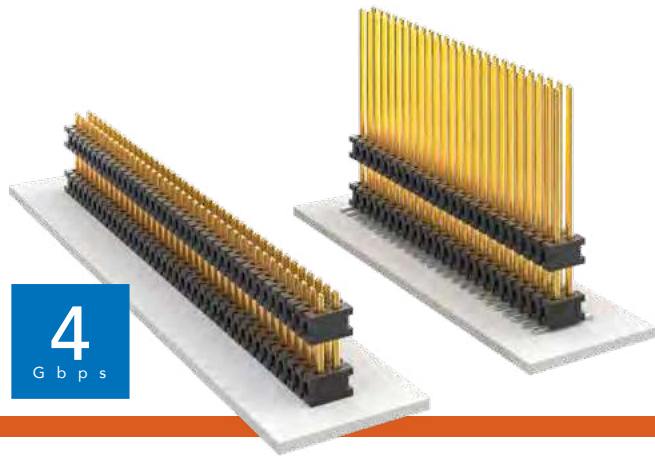

FW

Board Mates:

CLP, FLE

Cable Mates:

FFSD

SPECIFICATIONS

Insulator Material:

Black Liquid Crystal Polymer

Terminal Material:

Phosphor Bronze

Plating:

Sn or Au over 50 μ" (1.27 μm) Ni

Operating Temp Range:

-55 °C to +125 °C

PROCESSING

Lead-Free Solderable:

Yes

SMT Lead Coplanarity:

(0.10 mm) .004" max (02-30)

(0.15 mm) .006" max (31-50)*

*(.004" stencil solution

may be available; contact

ipg@samtec.com)

MATED HEIGHT

FW LEAD STYLE	CLP LEAD STYLE	MATED HEIGHT*
FW-XX-03-X-X-233-065	-02	8.13 mm) .329"
FW-XX-03-X-X-303-065		9.91 mm) .390"

*Processing conditions will affect mated height.

ALSO AVAILABLE

Smaller stack heights
(MOQ Required)

Notes:

For added mechanical stability, Samtec recommends mechanical board spacers be used in applications with gold or selective gold plated connectors. Contact ipg@samtec.com for more information.

This Series is non-standard, non-returnable.

FW	NO. OF PINS PER ROW	LEAD STYLE	PLATING OPTION	D	STACKER HEIGHT	POST HEIGHT	OPTION
----	---------------------	------------	----------------	---	----------------	-------------	--------

02 thru 50

Specify LEAD STYLE from chart

-F
= Gold flash on post, Matte Tin on tail

-L
= 10 μ" (0.25 μm) Gold on post, Matte Tin on tail

-G
= 10 μ" (0.25 μm) Gold on post, Gold flash on tail

-"XXX"
= Stacker Height (in inches)

Example:
-250 = (6.35 mm) .250"

-"XXX"
= Post Height (in inches)

(1.65 mm) .065" minimum

Example:
-.065 = (1.65 mm) .065"

-ES
= End Shroud (-075 post height only. Mate only with CLP) (5.46 mm) .215" to (15.49 mm) .610" stacker height only 9 pins/row min.

-EP
= End Shroud with Guide Post (-075 post height only. Mate only with CLP) (5.46 mm) .215" to (15.49 mm) .610" stacker height only 9 pins/row min.

-A
= Alignment Pin (3 positions min.) (5.46 mm) .215" to (15.75 mm) .620" stacker height only (SMT only)

-P
= Pick & Place Pad (5 positions min.) (SMT only)

-TR
= Tape & Reel (Max overall height = Post+Stacker Height+Pad+ Alignment Pin = (17.78) .700") (SMT only)

-FR
= Full Reel Tape & Reel (must order max. quantity per reel; contact Samtec for quantity breaks) (SMT only)

LEAD STYLE	STACKER HEIGHT	STACKER + POST
-03	(5.46) to (8.51) .215 to .335	(7.11) to (10.16) .280 to .400
-05	(8.64) to (15.49) .340 to .610	(10.29) to (17.15) .405 to .675

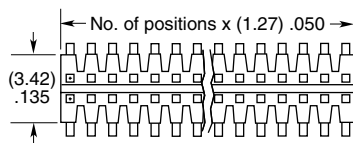

SURFACE MOUNT

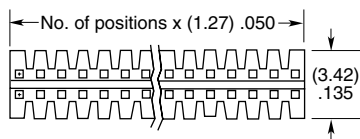
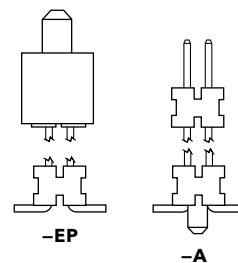
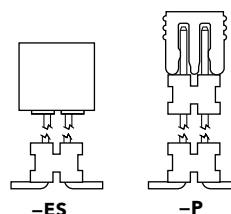
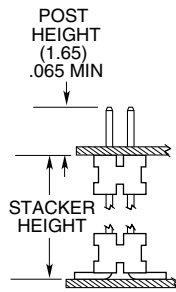
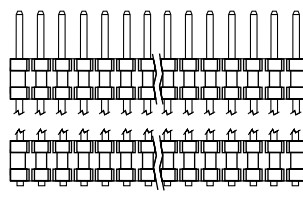

THROUGH-HOLE

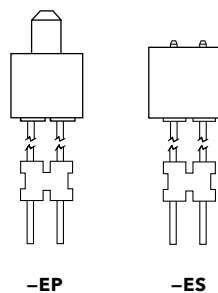
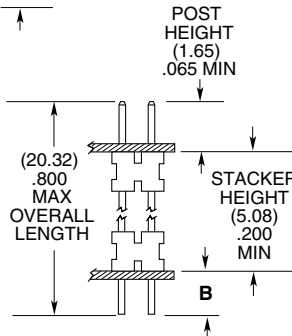
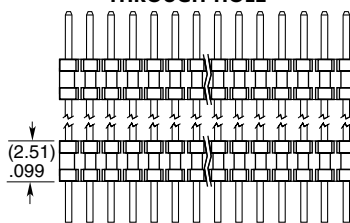

LEAD STYLE	TAIL (B)
-01	(1.14) .045
-02	(1.91) .075
-04	(2.29) .090

LOW PROFILE DUAL WIPE SOCKET

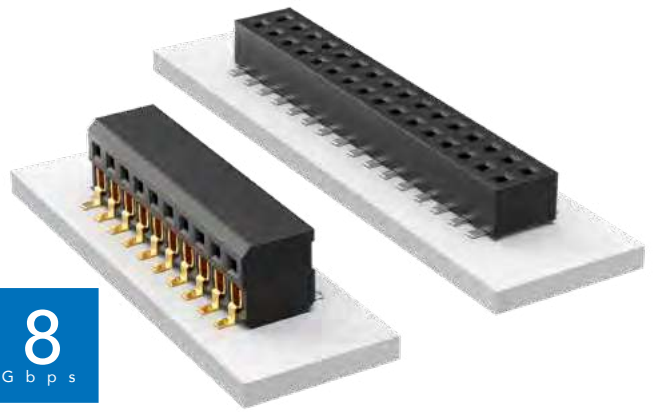

(1.27 mm) .050" PITCH • CLP SERIES

CLP

Mates:
FTSH, FTS, FW



02 thru 50

SPECIFICATIONS

Insulator Material:
Black Liquid Crystal Polymer
Contact Material:
Phosphor Bronze
Plating:
Sn or Au over
50 μ" (1.27 μm) Ni
Current Rating (CLP/FTSH):
3.4 A per pin
(2 pins powered)
Voltage Rating:
280 VAC/395 VDC
Operating Temp Range:
-55 °C to +125 °C
Insertion Depth:
Top Entry =
(1.40 mm) .055" minimum
Bottom Entry =
(2.41 mm) .095" minimum
plus board thickness
DH Entry =
(2.31 mm) .091" to (2.67 mm) .105"
Max Cycles:
100 with 10 μ" (0.25 μm) Au

PROCESSING

Lead-Free Solderable:
Yes
SMT Lead Coplanarity:
(0.10 mm) .004" max (02-35)
(0.15 mm) .006" max (36-50)*
*(.004" stencil solution
may be available; contact
ipg@samtec.com)

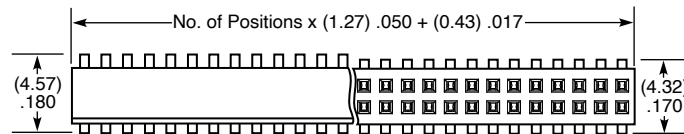

ALSO AVAILABLE

MOQ Required

Single row
Other platings

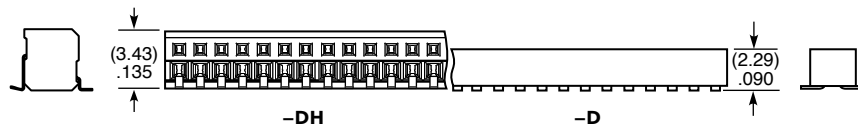

Notes:

Severe Environment
Testing qualified; aligns
with MIL-DTL-55302.
Visit samtec.com/set

Some lengths, styles and
options are non-standard,
non-returnable.

PIN/ROW	A
04-15	(3.56) .140
16-50	(7.11) .280

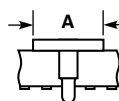

If odd pins/row, alignment pins are on
middle position on centerline of the part.
If even pins/row, then alignment pins are
between middle two positions.

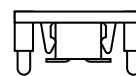

-PA OPTION



-P OPTION

OTHER OPTIONS

-BE
= Bottom Entry
(Required for bottom
entry applications)

-A
= Alignment Pin
(Not available with -PA option)
(05, 06, 07, 08, 10, 12, 15,
20, 25, 30, 40 positions only)
(-DH option and other sizes.
Contact Samtec.)

-K
= (4.00 mm) .157" DIA
Polyimide film Pick & Place Pad

-P
= Pick & Place Pad
(5 positions min. -D only)
(Not always necessary
for auto placement.
See Flex Processing.)

-PA
= Pick & Place Pad
with Alignment Pin
(-D only)
(Not available with -A option)

-TR
= Tape & Reel

-FR
= Full Reel Tape & Reel
(must order maximum
quantity per reel;
contact Samtec for
quantity breaks)

COST-EFFECTIVE RELIABLE SOCKET

(1.27 mm) .050" PITCH • FLE SERIES

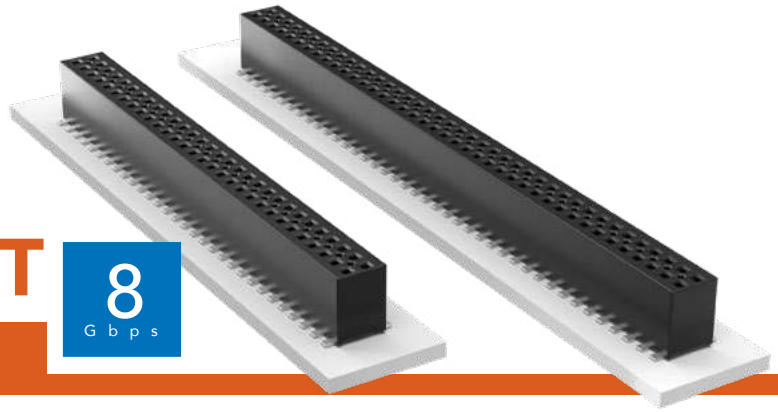

FLE

Board Mates:
FTSH, FTS, FW

Cable Mates:
FFMD*, FMTP

***Note:**
Standard FFMD callout will not mate with FLE, SFMC. Must use gold plated callouts. (See drawing on web.)



02 thru 50

-G
= 10 μm (0.25 μm) Gold

-A
= Alignment Pin (Metal or plastic at Samtec discretion) (3 positions minimum)

-K
= (4.25 mm) .167" DIA Polyimide film Pick & Place Pad (5 positions minimum)

-P
= Metal Pick & Place Pad (5 positions minimum)

-TR
= Tape & Reel

-FR
= Full Reel Tape & Reel (must order maximum quantity per reel; contact Samtec for quantity breaks)

SPECIFICATIONS

Insulator Material:
Black Liquid Crystal Polymer

Contact Material:
Phosphor Bronze

Plating:
Au over 50 μm (1.27 μm) Ni

Current Rating:
2.9 A per pin
(2 pins powered)

Operating Temp Range:
-55 °C to +125 °C

Insertion Depth:
(1.83 mm) .072" to (4.37 mm)
.172" or pass-through

Max Cycles:
100+

PROCESSING

Lead-Free Solderable:
Yes

SMT Lead Coplanarity:
(0.10 mm) .004" max

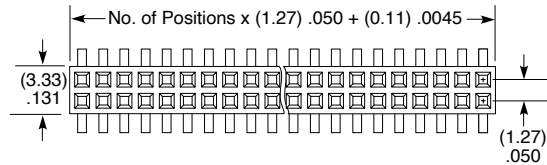

ALSO AVAILABLE

Other Plating
(MOQ Required)

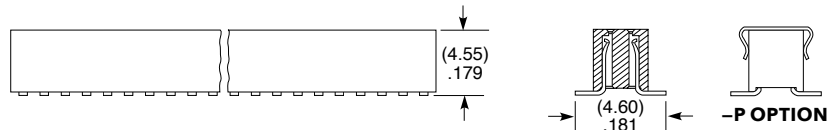

Note:
Some lengths, styles and options are non-standard, non-returnable.

THROUGH-HOLE MICRO HEADER

(1.27 mm) .050" PITCH • TMS/HTMS SERIES

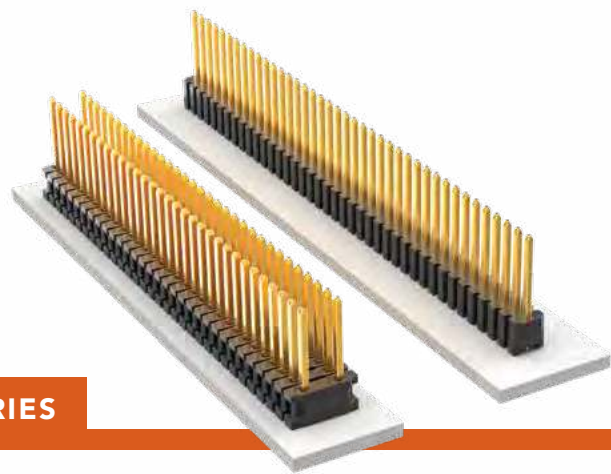

TMS/HTMS

Mates:
SMS, SLM, RSM

SPECIFICATIONS

Insulator Material:
Black Liquid Crystal Polymer
Terminal Material:
Phosphor Bronze
Plating:
Au or Sn over
50 μ " (1.27 μ m) Ni
Current Rating (TMS/SMS):
5 A per pin
(2 pins powered)
Operating Temp Range:
-55 °C to +105 °C with Tin;
-55 °C to +125 °C with Gold

PROCESSING

Lead-Free Solderable:
Yes

SERIES	1	NO. PINS PER ROW	LEAD STYLE	PLATING OPTION	ROW OPTION	OPTION
--------	---	------------------	------------	----------------	------------	--------

TMS
= Standard

01 thru 50

Specify
**LEAD
STYLE**
from
chart

-L
= 10 μ "
(0.25 μ m)
Gold on post,
Matte Tin
on tail

-S
= Single
Row
-D
= Double
Row

-RA
= Right-
angle
-"XXX"
= Polarized
Position
(Specify position
of omitted pin)

HTMS
= High Temp

-G
= 10 μ "
(0.25 μ m)
Gold on post,
Gold flash
on tail

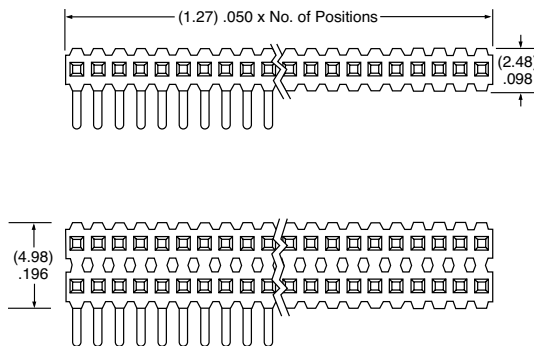

T/H LEAD STYLE	A	B	C
-01	(11.43) .450	(5.84) .230	(3.05) .120
-02	(8.13) .320	(2.54) .100	
-21	(12.83) .505	(5.84) .230	(4.45) .175
-51	(10.41) .410	(4.83) .190	
-52	(10.80) .425	(5.21) .205	
-53	(12.83) .505	(7.24) .285	
-54	(14.10) .555	(8.51) .335	
-55	(15.49) .610	(9.91) .390	(3.05) .120
-56	(15.88) .625	(10.29) .405	
-57	(16.51) .650	(10.92) .430	
-58	(17.91) .705	(12.32) .485	
-59	(19.18) .755	(13.59) .535	
-60	(20.96) .825	(15.37) .605	

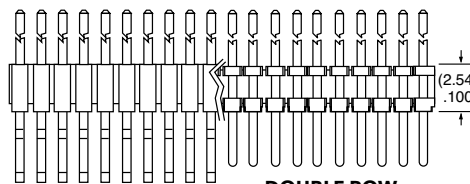

SINGLE ROW

DOUBLE ROW

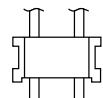
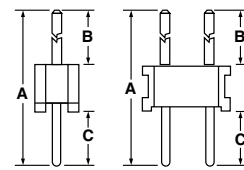

**HTMS
-D
BODY
DESIGN**

ALSO AVAILABLE

MOQ Required

Other Plating

Important Note:

Style -02 does not mate with SMS Series.

RA LEAD STYLE	D
-01	(5.84) .230
-02	(2.54) .100
-03	(3.18) .125

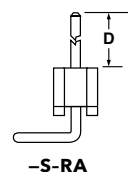

-S-RA

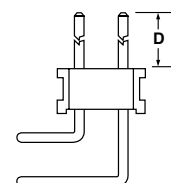

-D-RA

Note:

Some lengths, styles and options are non-standard, non-returnable.

SHROUDED HEADERS & STACKERS

(1.27 mm) .050" PITCH • TML/ZML SERIES



TML/ZML

Mates:
SMS, RSM

SPECIFICATIONS

TML

Insulator Material:
Black Liquid Crystal Polymer
Insulation Resistance:
5000 MΩ min
Terminal Material:
Phosphor Bronze
Plating:
Au or Sn over
50 μ" (1.27 μm) Ni
Operating Temp Range:
-55 °C to +105 °C with Tin;
-55 °C to +125 °C with Gold

ZML

Insulator Material:
Black Liquid Crystal Polymer
Terminal Material:
Phosphor Bronze
Plating:
Au or Sn over
50 μ" (1.27 μm) Ni
Operating Temp Range:
-55 °C to +105 °C with Tin;
-55 °C to +125 °C with Gold

PROCESSING

TML

Lead-Free Solderable:
Yes
SMT Lead Coplanarity:
(0.10 mm) .004" max (05-20)
(0.15 mm) .006" max (32)*
*(.004" stencil solution
may be available; contact
IPG@samtec.com)
ZML
Same as TML except:
SMT Lead Coplanarity:
(0.15 mm) .006" max*
*(.004" stencil solution
may be available; contact
ipg@samtec.com)

ALSO AVAILABLE

MOQ Required

Other sizes
Other platings

Notes:

For added mechanical stability, Samtec recommends mechanical board spacers be used in applications with gold or selective gold plated connectors. Contact ipg@samtec.com for more information.

Some sizes, styles and options are non-standard, non-returnable.

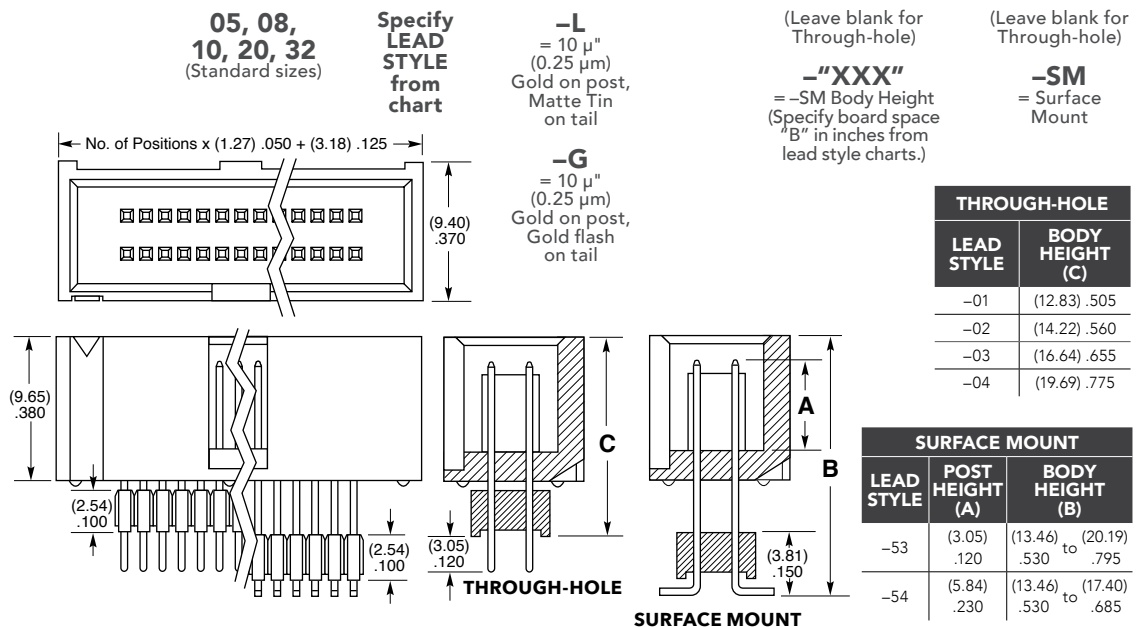
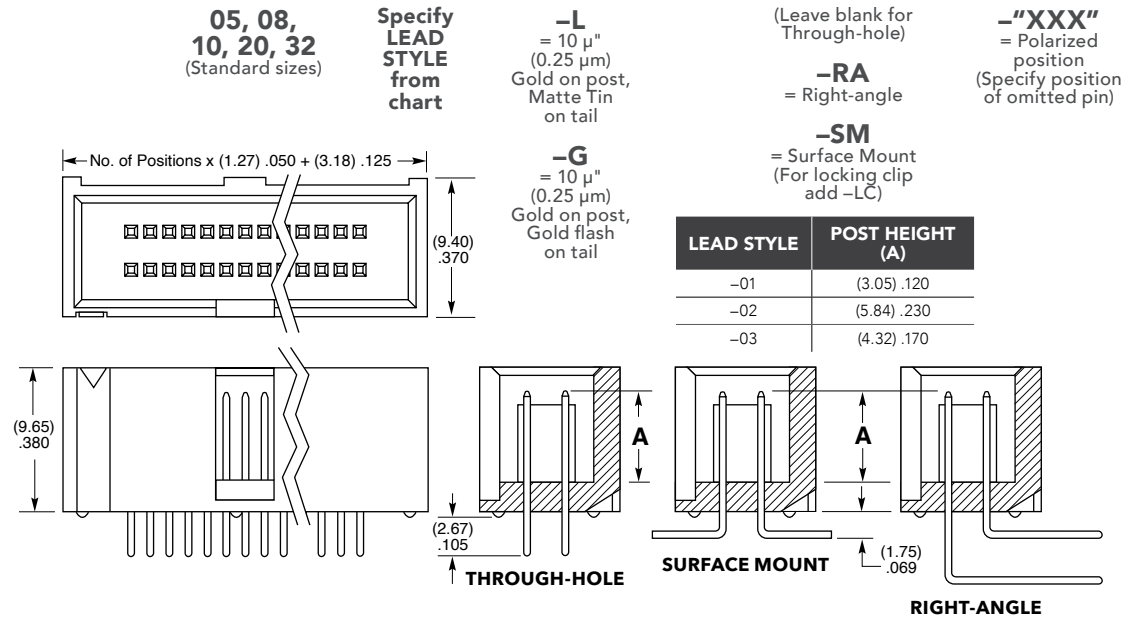

MICRO BOARD STACKER

(1.27 mm) .050" PITCH • DWM/HDWM SERIES

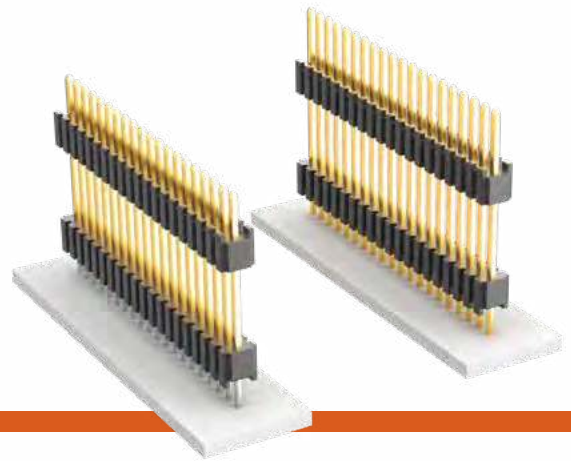

DWM/HDWM

Mates:
SMS, SLM, RSM

SPECIFICATIONS

Insulator Material:
Liquid Crystal Polymer
Terminal Material:
Phosphor Bronze
Plating:
Au or Sn over 50 μ" (1.27 μm) Ni
Operating Temp Range:
-55 °C to +105 °C with Tin
-55 °C to +125 °C with Gold

PROCESSING

Lead-Free Solderable:
Yes
SMT Lead Coplanarity:
(0.15 mm) .006" max*
*(.004" stencil solution may be available; contact ipg@samtec.com)

ALSO AVAILABLE

Other Platings
(MOQ Required)

DWM	NO. PINS PER ROW	LEAD STYLE	PLATING OPTION	ROW OPTION	STACKER HEIGHT	OTHER OPTION
	01 thru 50	Specify LEAD STYLE from chart	-L = 10 μ" (0.25 μm) Gold on contact, Matte Tin on tail -G = 10 μ" (0.25 μm) Gold on contact, Gold flash on tail	-S = Single Row -D = Double Row	- "XXX" = Stacker Height Example: -200 = (5.08 mm) .200"	- "XXX" = Polarized Position (Specify position of omitted pin)

OAL	
LEAD STYLE	THROUGH-HOLE
-01	(11.43) .450
-51	(10.41) .410
-52	(10.80) .425
-53	(12.83) .505
-54	(14.10) .555
-55	(15.49) .610
-56	(15.88) .625
-57	(16.51) .650
-58	(17.91) .705
-59	(19.18) .755
-60	(20.96) .825
-61	(26.67) 1.050

HDWM	NO. PINS PER ROW	LEAD STYLE	PLATING OPTION	ROW OPTION	STACKER HEIGHT	OTHER OPTION
	01 thru 50	Specify LEAD STYLE from chart	-L = 10 μ" (0.25 μm) Gold on contact, Matte Tin on tail -G = 10 μ" (0.25 μm) Gold on contact, Gold flash on tail	-S = Single Row -D = Double Row	- "XXX" = Stacker Height Example: -250 = (6.35 mm) .250"	- "XXX" = Polarized Position (Specify position of omitted pin) - SM = Surface Mount (02 thru 40 positions only) - A = Alignment Pin (6 positions minimum -D only) Metal or plastic at Samtec discretion (Not available with -LC) - LC = Locking Clip (5 positions minimum -D only) (Not available with -A) (Manual placement required) - P = Pick & Place Pad

OAL		
LEAD STYLE	THROUGH-HOLE	SURFACE MOUNT
-01	(11.43) .450	(8.38) .330
-51	(10.41) .410	—
-52	(10.80) .425	—
-53	(12.83) .505	(9.78) .385
-54	(14.10) .555	(11.05) .435
-55	(15.49) .610	(12.45) .490
-56	(15.88) .625	(12.83) .505
-57	(16.51) .650	(13.46) .530
-58	(17.91) .705	(14.86) .585
-59	(19.18) .755	(15.62) .615
-60	(20.96) .825	—
-61	(26.67) 1.050	—

Notes:
For added mechanical stability, Samtec recommends mechanical board spacers be used in applications with gold or selective gold plated connectors. Contact ipg@samtec.com for more information.

This Series is non-standard, non-returnable.

SMT MICRO HEADER & SOCKET

(1.27 mm) .050" PITCH • FTR/RSM SERIES

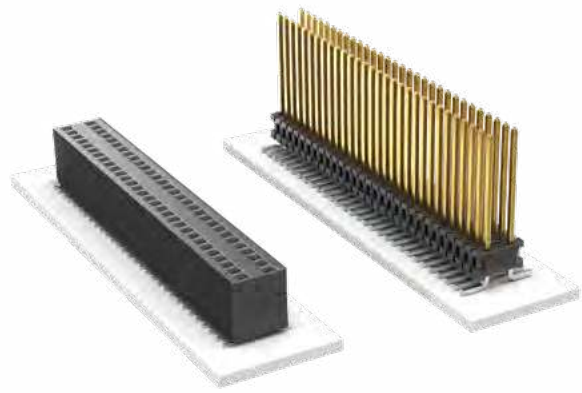

FTR
Mates:
RSM, SMS, SLM

RSM
Mates:
FTR, HTMS, HDWM,
DWM, TML, ZML, TMS

SPECIFICATIONS

Insulator Material:
Black Liquid Crystal Polymer
Contact Material:
RSM: Phosphor Bronze
Terminal Material:
FTR: Phosphor Bronze
Plating:
Au or Sn over
50 μ " (1.27 μ m) Ni
Operating Temp Range:
FTR: -55 °C to +105 °C with Tin;
FTR: -55 °C to +125 °C with Gold
RSM: -55 °C to +125 °C
Current Rating (FTR/RSM):
3.8 A per pin
(2 pins powered)
Voltage Rating:
290 VAC
Lead Size Accepted:
RSM: (0.46 mm) .018" SQ
Insertion Depth:
RSM: Top Entry =
(2.64 mm) .104" to (5.84 mm) .230"
with (0.38 mm) .015" wipe, or
pass-through.
RSM: Bottom Entry =
(5.49 mm) .216" minimum
(Add board thickness for
correct post OAL)

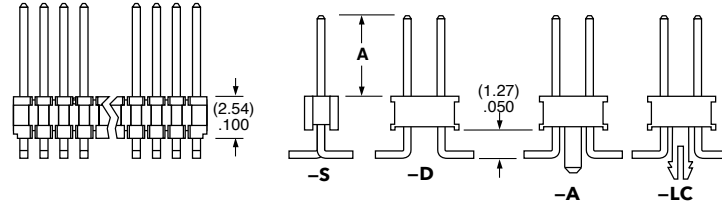
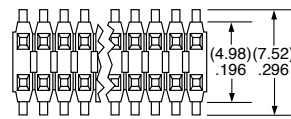
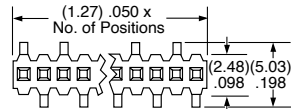

FTR	1	NO. PINS PER ROW	LEAD STYLE	PLATING OPTION	ROW OPTION	OPTION																						
		02 thru 40	Specify LEAD STYLE from chart	-L = 10 μ " (0.25 μ m) Gold on post, Matte Tin on tail -G = 10 μ " (0.25 μ m) Gold on post, Gold flash on tail	-S = Single Row -D = Double Row	-XX = Polarized -A = Alignment Pin (5 positions min. for -D) (Metal or plastic at Samtec discretion) (Not available with -LC) -LC = Locking Clip (6 positions min. for -D) (Not available with -A) (Manual placement required) -P = Plastic Pick & Place Pad (5 positions min. for -D) (8 positions min. for -S) -TR = Tape & Reel (4 positions min. for -S) -FR = Full Reel Tape & Reel (must order max. quantity per reel; contact Samtec for quantity breaks) (4 positions min. for -S)																						
						<table border="1"> <thead> <tr> <th>LEAD STYLE</th> <th>A</th> </tr> </thead> <tbody> <tr><td>-01</td><td>(5.84) .230</td></tr> <tr><td>-02</td><td>(2.54) .100</td></tr> <tr><td>-03</td><td>(3.18) .125</td></tr> <tr><td>-51</td><td>(4.83) .190</td></tr> <tr><td>-52</td><td>(5.21) .205</td></tr> <tr><td>-53</td><td>(7.24) .285</td></tr> <tr><td>-54</td><td>(8.51) .335</td></tr> <tr><td>-55</td><td>(9.91) .390</td></tr> <tr><td>-56</td><td>(10.29) .405</td></tr> <tr><td>-57</td><td>(10.92) .430</td></tr> </tbody> </table>	LEAD STYLE	A	-01	(5.84) .230	-02	(2.54) .100	-03	(3.18) .125	-51	(4.83) .190	-52	(5.21) .205	-53	(7.24) .285	-54	(8.51) .335	-55	(9.91) .390	-56	(10.29) .405	-57	(10.92) .430
LEAD STYLE	A																											
-01	(5.84) .230																											
-02	(2.54) .100																											
-03	(3.18) .125																											
-51	(4.83) .190																											
-52	(5.21) .205																											
-53	(7.24) .285																											
-54	(8.51) .335																											
-55	(9.91) .390																											
-56	(10.29) .405																											
-57	(10.92) .430																											

PROCESSING

Lead-Free Solderable:
Yes
SMT Lead Coplanarity:
RSM: (0.10 mm) .004" max
FTR: (0.10 mm) .004" max (02-20)
FTR: (0.15 mm) .006" max (21-40)*
*(.004" stencil solution
may be available; contact
ipg@samtec.com)

RSM	1	NO. PINS PER ROW	02	PLATING OPTION	ROW OPTION	OPTION
		02 thru 36		-L = 10 μ " (0.25 μ m) Gold on contact, Matte Tin on tail	-S = Single Row -D = Double Row	-K = (6.25 mm) .246" DIA Polyimide film Pick & Place Pad (5 positions minimum for -D) (7 positions minimum for -S) -P = Plastic Pick & Place Pad (5 positions minimum for -D) (6 positions minimum for -S) -TR = Tape & Reel -FR = Full Reel Tape & Reel (must order max. quantity per reel; contact Samtec for quantity breaks)
						<p>ALSO AVAILABLE MOQ Required</p> <p>Other platings Locking clips</p>
						<p>(1.27) .050 x No. of Positions + (0.25) .010</p> <p>(2.54) .100</p> <p>(5.08) .200</p> <p>(6.10) .240</p> <p>(3.94) .155</p> <p>(6.48) .255</p> <p>-S -D</p>

Note:
Some lengths, styles and
options are non-standard,
non-returnable.

THROUGH-HOLE MICRO SOCKETS

(1.27 mm) .050" PITCH • SLM/SMS SERIES

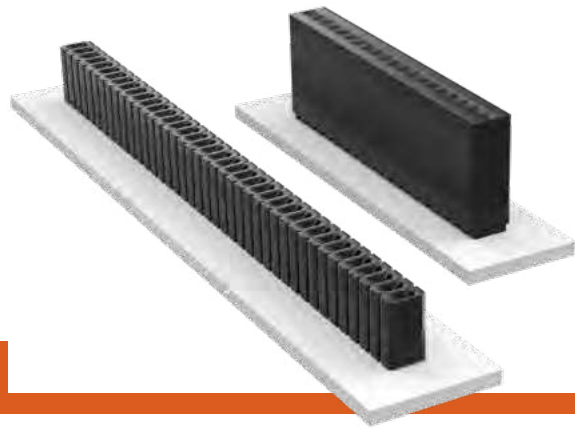

SLM

Mates:
HTMS, TMS, MTMS, DWM,
HDWM, FTR, HMTMS

SMS

Mates:
HTMS, TMS, MTMS,
DWM, HDWM, FTR, TML,
ZML, HMTM

SPECIFICATIONS

Insulator Material:
SLM: Black Glass Filled Polyester
SMS: Black LCP

Contact Material:
Phosphor Bronze

Plating:
Au or Sn over
50 μ" (1.27 μm) Ni

Current Rating (SLM/TMS):
5.2 A per pin
(2 pins powered)

Current Rating (SMS/TMS):
5.0 A per pin
(2 pins powered)

Operating Temp Range:
-55 °C to +125 °C with Gold
-55 °C to +105 °C with Tin

Insertion Depth:
SLM: (2.03 mm) .080"
to (3.05 mm) .120"
SMS: (3.43 mm) .135" to
(6.35 mm) .250" with
(0.38 mm) .015" wipe

PROCESSING

Lead-Free Solderable:
SLM: No, Lead Wave Only
SMS: Yes

ALSO AVAILABLE

Other Platings
(MOQ Required)

Note:
Some lengths, styles and
options are non-standard,
non-returnable.

SLM	-	1	NO. PINS PER ROW	-	01	PLATING OPTION	-	ROW OPTION
-----	---	---	------------------	---	----	----------------	---	------------

01 thru 50

-L
= 10 μ" (0.25 μm) Gold on contact,
Matte Tin on tail

-G
= 20 μ" (0.51 μm) Gold on contact,
Gold flash on balance

-S
= Single Row

-D
= Double Row

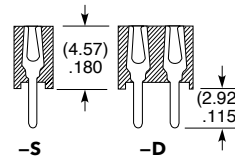
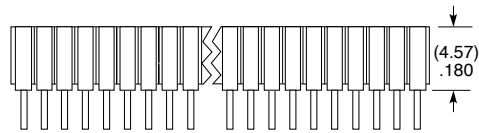
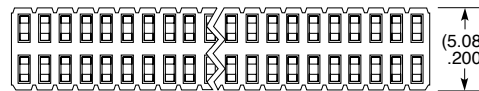
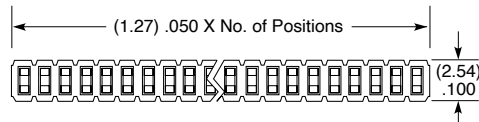

SMS	-	1	NO. PINS PER ROW	-	LEAD STYLE	PLATING OPTION	-	ROW OPTION
-----	---	---	------------------	---	------------	----------------	---	------------

01 thru 50

Specify
LEAD
STYLE
from
chart

-L
= 10 μ" (0.25 μm) Gold on contact,
Matte Tin on tail

-G
= 20 μ" (0.51 μm) Gold on contact,
Gold flash on balance

-S
= Single Row

-D
= Double Row

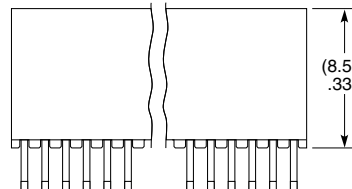
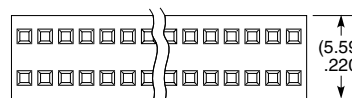
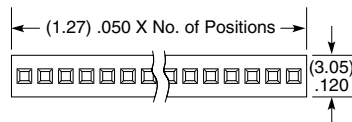

LEAD STYLE	A
-01	(2.54) .100
-02	(4.83) .190

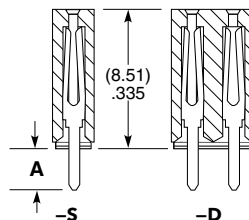

LOW PROFILE SMT HEADER

(2.00 mm) .0787" PITCH • TMM SERIES

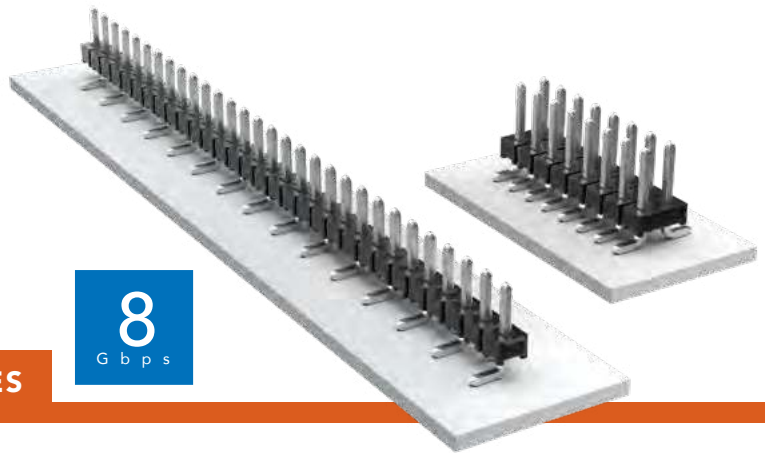

TMM

Board Mates:
CLT, SQT, SQW, ESQT,
TLE, SMM, MMS

Cable Mates:
TCSD

SPECIFICATIONS

Insulator Material:
Black Liquid Crystal Polymer
Terminal Material:
Phosphor Bronze
Plating:
Sn or Au over
50 μ " (1.27 μ m) Ni
Current Rating:
3.2 A per pin
(2 pins powered)
Operating Temp Range:
-55 °C to +105 °C with Tin;
-55 °C to +125 °C with Gold
Voltage Rating:
281 VAC mated with SQW;
250 VAC mated with SQT

PROCESSING

Lead-Free Solderable:
Yes
SMT Lead Coplanarity:
(0.15 mm) .006" max*
*(.004" stencil solution
may be available; contact
ipg@samtec.com)

ALSO AVAILABLE

Other plating
(MOQ Required)



Note:
Some lengths, styles and
options are non-standard,
non-returnable.

TMM	1	NO. PINS PER ROW	LEAD STYLE	PLATING OPTION	ROW OPTION	SM	OTHER OPTION
------------	----------	-------------------------	-------------------	-----------------------	-------------------	-----------	---------------------

02 thru 40

Specify
**LEAD
STYLE**
from
chart

-F
= Gold flash
on post,
Matte Tin on tail

-L
= 10 μ " (0.25 μ m)
Gold on post,
Matte Tin on tail

-S
= 30 μ " (0.76 μ m)
Gold on post,
Matte Tin on tail

-T
= Matte Tin

-S
= Single
Row

-D
= Double
Row

-A
= Alignment Pin
(Metal or plastic
at Samtec's
discretion)
(5 positions
minimum)
(-D only)

-"XXX"
= Polarized
Position
(Specify
position of
omitted pin)

-P
= Pick &
Place Pad
(3 positions
minimum)

-TR
= Tape & Reel
(3 thru 36
positions only)

-FR
= Full Reel
Tape & Reel
(must order max.
quantity per reel;
contact
Samtec for
quantity breaks)
(3 thru 36
positions only)

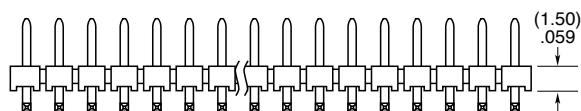
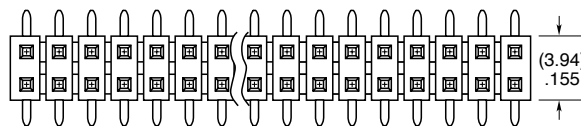
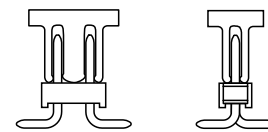
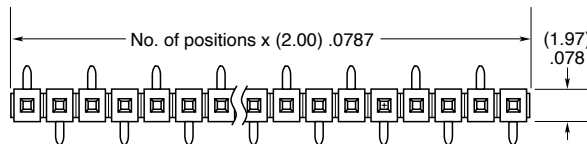

LEAD STYLE	A	MATES WITH
-01	(3.20) .126	SQT, SQW, ESQT, TLE, SMM, MMS, TCSD
-04	(1.91) .075	CLT
-05	(1.65) .065	
-06	(4.27) .168	CLT-BE

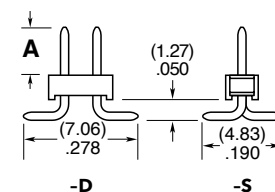

THROUGH-HOLE LOW PROFILE HEADER

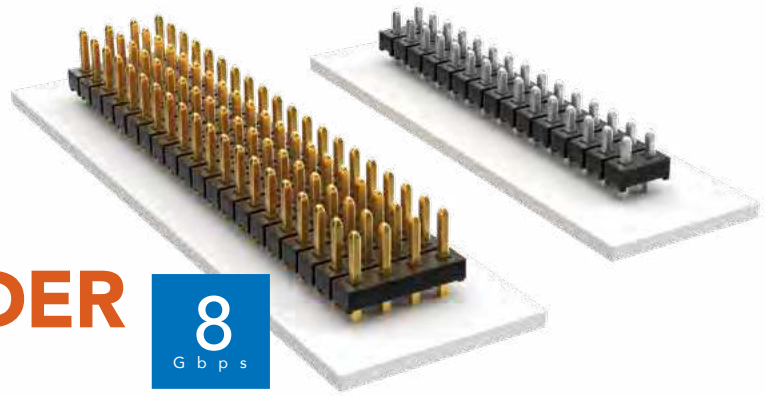

(2.00 mm) .0787" PITCH • TMM SERIES

TMM

Board Mates:
CLT, SQT, SQW, ESQT,
TLE, SMM, MMS

Cable Mates:
TCSD

SPECIFICATIONS

Insulator Material:
Black Liquid Crystal Polymer
Terminal Material:
Phosphor Bronze
Plating:
Sn or Au over
50 μ" (1.27 μm) Ni
Current Rating (SMM/TMM):
3.2 A per row
(2 pins powered)
Operating Temp Range:
-55 °C to +105 °C with Tin;
-55 °C to +125 °C with Gold
Voltage Rating:
281 VAC mated with SQW;
250 VAC mated with SQT

PROCESSING

Lead-Free Solderable:
Yes

APPLICATION

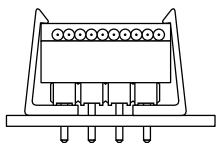

Retention Clip Option (-RC)

ALSO AVAILABLE

MOQ Required

Other Platings



Note:
Some lengths, styles and options are non-standard, non-returnable.

TMM	- 1	NO. PINS PER ROW	LEAD STYLE	PLATING OPTION	ROW OPTION	OTHER OPTION
-----	-----	------------------	------------	----------------	------------	--------------

02 thru 50

Specify LEAD STYLE from chart

-F
= Gold flash on post, Matte Tin on tail

-L
= 10 μ" (0.25 μm) Gold on post, Matte Tin on tail

-S
= 30 μ" (0.76 μm) Gold on post, Matte Tin on tail

-T
= Matte Tin

-S
= Single Row

-D
= Double Row

-Q
= Four Row

-RA & -RE
= Right-angle (Lead Style -01 only) (2 positions minimum, -Q row)

-RC
= Retention Clip (Mates with TCSD) (Double row only, 4 positions minimum, only available -06 lead style)

-"XXX"
= Polarized Position (Specify position of omitted pin)

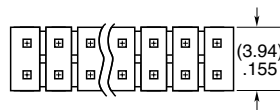
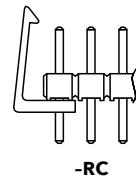
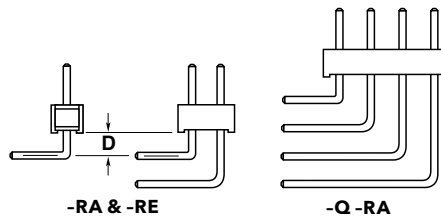
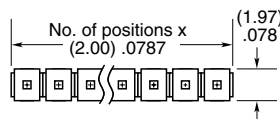

OPTION	D
-RA	(1.27) .050
-RE	(3.56) .140

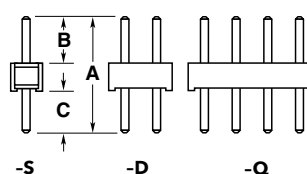
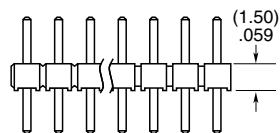
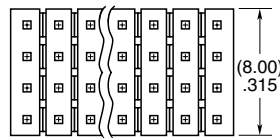

LEAD STYLE	A	B	C
-01		(3.20) .126	(3.50) .138
-02	(8.20) .323	(3.70) .146	(3.00) .118
-03		(4.00) .158	(2.70) .106
-04	(5.69) .224	(1.91) .075	(2.29) .090
-05	(5.43) .214	(1.65) .065	
-06	(9.58) .377	(3.20) .126	(4.88) .192

HORIZONTAL & MODIFIED HEADERS

(2.00 mm) .0787" PITCH • MMT/MTMM SERIES

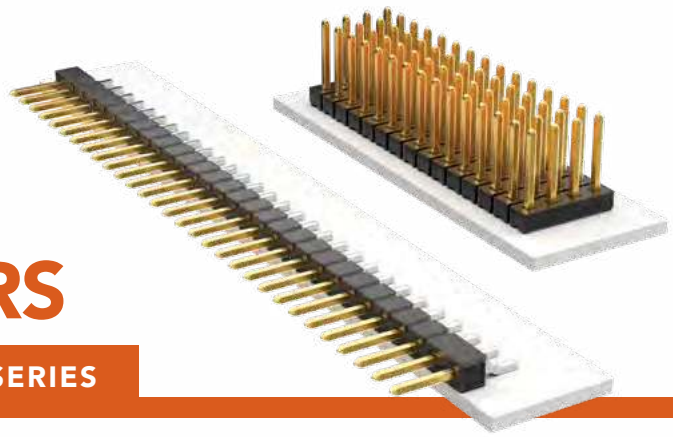

MMT/MTMM

Board Mates:

CLT, SQT*, SQW, ESQT, TLE, SMM, MMS

Cable Mates:

TCSD

*Important Note:

SQT will not mate to the MMT -02 lead style.

SPECIFICATIONS

Insulator Material:

Black Liquid Crystal Polymer

Terminal Material:

Phosphor Bronze

Plating:

Au or Sn over 50 μ" (1.27 μm) Ni

Operating Temp Range:

-55 °C to +105 °C with Tin;
-55 °C to +125 °C with Gold

PROCESSING

Lead-Free Solderable:

Yes

SMT Lead Coplanarity (MMT):

(0.10 mm) .004" max (02-25)
(0.15 mm) .006" max (26-36)*
*(.004" stencil solution may be available; contact ipg@samtec.com)

MMT	1	NO. PINS PER ROW	LEAD STYLE	PLATING OPTION	ROW OPTION	OPTION
		02 thru 36	-01 = (3.20 mm) .126" post -02 = (4.45 mm) .175" post	-F = Gold flash on post, Matte Tin on tail -L = 10 μ" (0.25 μm) Gold post, Matte Tin on tail -T = Matte Tin	-SH = Single Row -DH = Double Row -MT = Double Row Mixed Technology	-K = (4.00 mm) .157" DIA Polyimide Film Pick & Place Pad (3 positions min.) -P = Pick & Place Pad (2 positions min.) -"XXX" = Polarized Position Specify position of omitted pin -TR = Tape & Reel -FR = Full Reel Tape & Reel (must order max. quantity per reel; contact Samtec for quantity breaks)

ALSO AVAILABLE
 MOQ Required
 Alignment pins
 Locking clips
 Molded pick & place pads

MTMM	1	NO. PINS PER ROW	LEAD STYLE	PLATING OPTION	ROW OPTION	POST HEIGHT	OPTION
		01 thru 50	Specify LEAD STYLE from chart	-F = Gold flash on post, Matte Tin on tail -L = 10 μ" (0.25 μm) Gold post, Matte Tin on tail -T = Matte Tin	-S = Single Row -D = Double Row -Q = Quad Row	-"XXX" = Post Height in inches (0.13 mm) .005" increments Example: -.070 = (1.78 mm) .070"	-"XXX" = Polarized Position Specify position of omitted pin

LEAD STYLE	OAL
-02	(6.48) .255
-03	(7.67) .302
-04	(8.20) .323
-05	(9.58) .377
-06	(10.08) .397
-07	(11.58) .456
-08	(12.09) .476
-09	(13.59) .535
-10	(14.10) .555
-11	(15.09) .594
-12	(15.60) .614
-13	(17.09) .673
-14	(19.08) .751
-15	(21.08) .830

Note:

Some lengths, styles and options are non-standard, non-returnable.

FLEXIBLE SMT HEADER

(2.00 mm) .0787" PITCH • TMMH SERIES

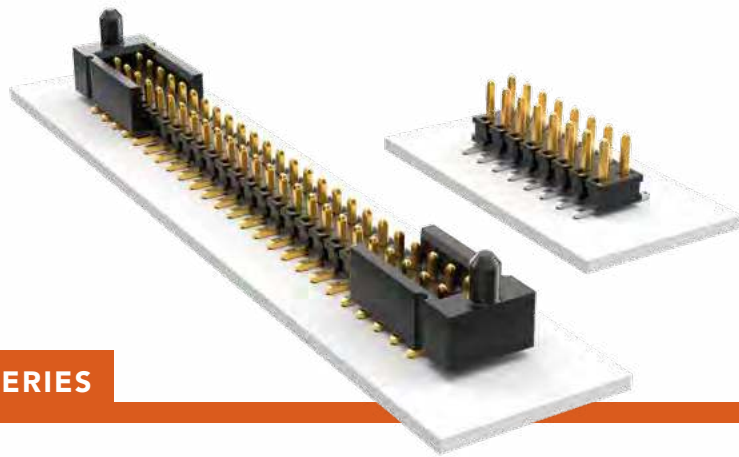

TMMH

Board Mates:

CLT, SQT, SQW, ESQT, TLE, SMM, MMS

Cable Mates:

TCSD

SPECIFICATIONS

Insulator Material:

Black Liquid Crystal Polymer

Terminal Material:

Phosphor Bronze

Plating:

Sn or Au over 50 μ" (1.27 μm) Ni

Current Rating (TMMH/ESQT):

4.5 A per pin

(2 pins powered)

Current Rating (TMMH/SQT):

5.1 A per pin

(2 pins powered)

Operating Temp Range:

-55 °C to +105 °C with Tin;

-55 °C to +125 °C with Gold

Voltage Rating:

281 VAC mated with SQW;

250 VAC mated with SQT

PROCESSING

Lead-Free Solderable:

Yes

SMT Lead Coplanarity:

(0.10 mm) .004" max

TMMH	1	NO. PINS PER ROW	LEAD STYLE	PLATING OPTION	DV	FLEX SHROUD OPTIONS	OTHER OPTIONS
------	---	------------------	------------	----------------	----	---------------------	---------------

03
thru
50

Specify
LEAD
STYLE
from
chart

-F
= Gold flash
on post,
Matte Tin
on tail

-L
= 10 μ"
(0.25 μm)
Gold on
post,
Matte Tin
on tail

-T
= Matte Tin

All Flex Shroud options
require 9 pins/row minimum
(For board-to-board
interfaces. Will not
mate with TCSD)

-ES
= End Shroud
(For best cost also
see TSH Series)

-EC
= End Shroud
with Locking Clip
(For best cost also
see TSH Series)
(Manual placement
required)

-EP
= End Shroud
with Guide Post

-EL
= End Shroud
with Board Lock
(Boards are positively
locked and cannot be
unmated)

-EBC
= End Shroud
with Board Lock
and Locking Clip
(Boards are positively
locked and cannot
be unmated)

-EPC
= End Shroud
with Guide Post
and Locking Clip
(Manual placement
required)

-"XXX"
= Polarized Position.
Specify position of
omitted pin

-A
= Alignment Pin
(3 positions minimum)
(Not available with -LC)

-LC
= Locking Clip
(5 positions minimum)
(Not available with -A)
(Manual placement
required)

-M
= Pick & Place Pad
(5 positions minimum)

-TR
= Tape & Reel Packaging
(36 positions maximum)
(Flex Shroud options
not available except
-ES, -EP & -EL)

-FR
= Full Reel
Tape & Reel
(must order max.
quantity per reel;
contact Samtec for
quantity breaks)
(36 positions maximum)
(Flex Shroud options
not available except
-ES, -EP & -EL)

OPTION	Z
-ES	(2.92) .115
-EC	(4.70) .185
-EP & -EPC	(6.10) .240
-EL & -EBC	(4.45) .175

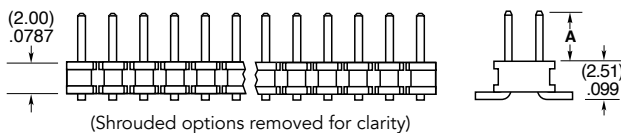
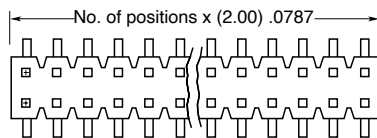
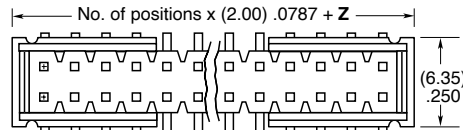

LEAD STYLE	A	MATES WITH
-01	(3.20) .126	SQT, SQW, ESQT, TLE, SMM, MMS, TCSD
-04	(1.91) .075	CLT
-05	(1.65) .065	



ALSO AVAILABLE

MOQ Required

Other Platings

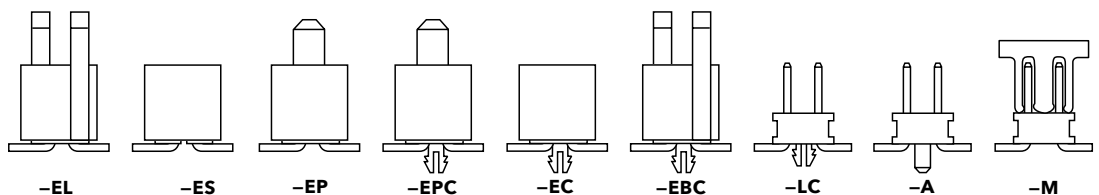

Note:

Some lengths, styles and options are non-standard, non-returnable.

FLEXIBLE THROUGH-HOLE HEADER

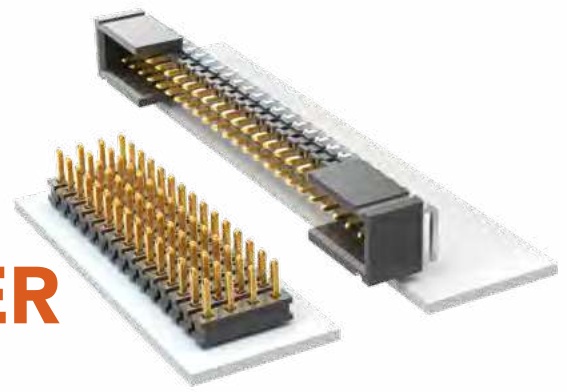

(2.00 mm) .0787" PITCH • TMMH SERIES

TMMH

Board Mates:
CLT, SQT, SQW, ESQT, TLE, SMM, MMS

Cable Mates:
TCSD

SPECIFICATIONS

Insulator Material:
Black Liquid Crystal Polymer

Terminal Material:
Phosphor Bronze

Plating:
Sn or Au over 50 μ" (1.27 μm) Ni

Current Rating (TMMH/ESQT):
4.5 A per pin
(2 pins powered)

Current Rating (TMMH/SQT):
5.1 A per pin
(2 pins powered)

Operating Temp Range:
-55 °C to +105 °C with Tin;
-55 °C to +125 °C with Gold

Voltage Rating:
281 VAC mated with SQW;
250 VAC mated with SQT

PROCESSING

Lead-Free Solderable:
Yes

APPLICATION

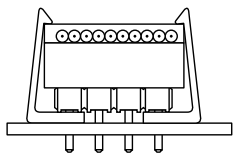

Retention Clip Option (-RC)

ALSO AVAILABLE

MOQ Required

Other Platings



Note:
Some lengths, styles and options are non-standard, non-returnable.

TMMH	1	NO. PINS PER ROW	LEAD STYLE	PLATING OPTION	ROW OPTION	TAIL OPTION	FLEX SHROUD OPTIONS	OTHER OPTIONS
------	---	------------------	------------	----------------	------------	-------------	---------------------	---------------

03
thru
50

Specify
LEAD
STYLE
from
chart

-F
= Gold flash on post, Matte Tin on tail

-D
= Double Row (Required for Flex Shroud option)

-RA
= Right-angle (Double & Triple Row only) (-ES, -EP, -EL Double Row only) (-EC, -EBC and -EPC not available) (-06 Lead style not available)

Flex Shroud requires -D row & 9 pins/row minimum (For board-to-board interfaces. Will not mate with TCSD)

-"XXX"
= Polarized Position (Specify position of omitted pin)

OPTION	Z
-ES	(2.92) .115
-EC	(4.70) .185
-EP & -EPC	(6.10) .240
-EL & -EBC	(4.45) .175

-L
= 10 μ" (0.25 μm) Gold on post, Matte Tin on tail

-T
= Triple Row

-Q
= Four Row

-T
= Matte Tin

-5
= Five Row

-6
= Six Row

-ES
= End Shroud

-EC
= End Shroud with Locking Clip (Manual placement required)

-RC
= Retention Clip (Mates to TCSD) (Double row only, minimum position 4 and available only -06 lead style)

-EP
= End Shroud with Guide Post

-EL
= End Shroud with Board Lock (Boards are positively locked and cannot be unmated)

-EBC
= End Shroud with Board Lock and Locking Clip (Boards are positively locked and cannot be unmated)

-EPC
= End Shroud with Guide Post and Locking Clip (Manual placement required)

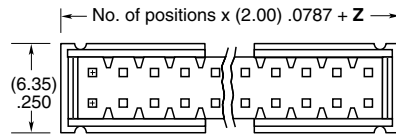

(Shrouded option requires -D)

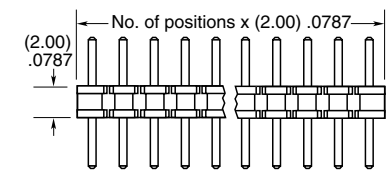
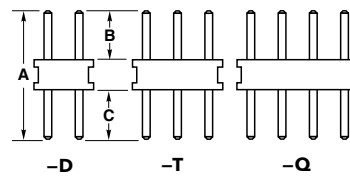
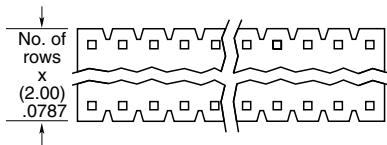

(Shrouded options removed for clarity)

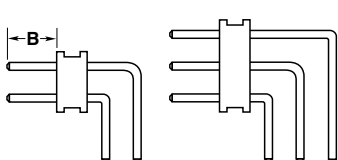
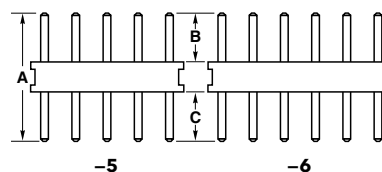

-RA
-T-RA
(Lead style -01 only)

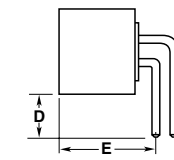

-D-RA-ES
(-RA also available with other flex shroud options)

LEAD STYLE	A	B	C	D	E	F	G
-01	(7.67) .302	(3.20) .126	(2.46) .097	(2.34) .092	(6.60) .260	(5.84) .230	(4.45) .175
-04	(6.45) .254	(1.91) .075	(2.57) .101	(2.62) .103	(5.26) .207	(4.50) .177	(3.02) .119
-05	(6.45) .254	(1.65) .065	(2.29) .090	(3.12) .123	(5.26) .207		
-06	(8.74) .344	(3.20) .126	(3.53) .139	N/A	N/A	N/A	N/A

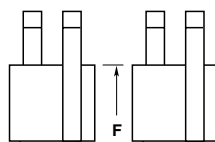

-D-EL
-D-EBC

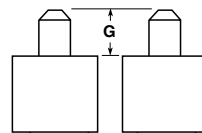

-D-EPC
-D-EP



-D-ES



-D-EC

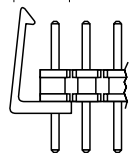

-RC

SHROUDED HEADER & STACKER

(2.00 mm) .0787" PITCH • LTMM/ZLTM SERIES

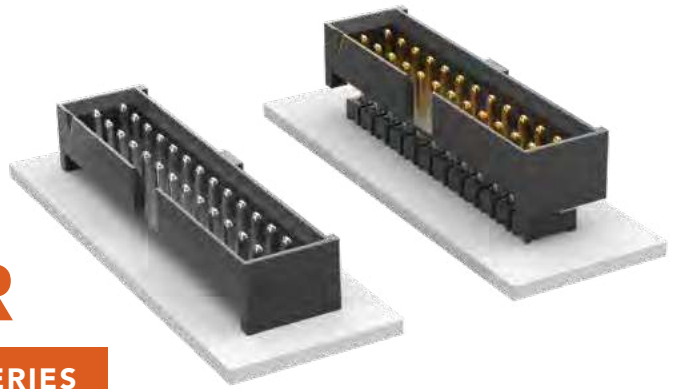

LTMM/ZLTM

Mates:

SQT, SQW, ESQT, SMM

SPECIFICATIONS

Insulator Material:

Black Liquid Crystal Polymer

Terminal Material:

Phosphor Bronze

Plating:

Sn or Au over
50 μ" (1.27 μm) Ni

Operating Temp Range:

-55 °C to +105 °C with Tin;
-55 °C to +125 °C with Gold

PROCESSING

Lead-Free Solderable:

Yes

SMT Lead Coplanarity:

(0.10 mm) .004" max

LTMM	1	NO. PINS PER ROW	PLATING OPTION	D	TAIL OPTION	OTHER OPTION
		04, 05, 06, 07, 08, 10, 12, 13, 15, 17, 20, 22, 25 (Standard sizes)	-F = Gold flash on post, Matte Tin on tail -L = 10 μ" (0.25 μm) Gold on post, Matte Tin on tail -T = Matte Tin		Leave blank for Through-hole -RA = Right-angle -SM = Surface Mount	-“XX” = Polarized Position -LC = Locking Clip (-SM only) (Manual placement required) -K = (7.50 mm) .295" DIA Film Pick & Place Pad (-SM only) -TR = Tape & Reel (-SM only) -FR = Full Reel Tape & Reel (must order max. quantity per reel; contact Samtec for quantity breaks) (-SM only)

ALSO AVAILABLE

MOQ Required

Other sizes
Other plating

ZLTM	1	NO. PINS PER ROW	LEAD STYLE	PLATING OPTION	D	BODY HEIGHT	OTHER OPTION
		04, 05, 06, 07, 08, 10, 12, 13, 15, 17, 20, 22, 25 (Standard sizes)	Specify LEAD STYLE from chart	-F = Gold flash on post, Matte Tin on tail -L = 10 μ" (0.25 μm) Gold on post, Matte Tin on tail -T = Matte Tin		-“XXX” = Body Height	-“XX” = Polarized Position

LEAD STYLE	B (OAL)	MAX BODY HEIGHT
-75	(9.58) 0.377	(7.42) 0.292
-62	(10.08) 0.397	(7.92) 0.312
-65	(10.49) 0.413	(8.33) 0.328
-73	(12.09) 0.476	(9.93) 0.391
-63	(14.10) 0.555	(11.94) 0.470
-66	(15.09) 0.594	(12.93) 0.509
-69	(15.60) 0.614	(13.44) 0.529
-74	(17.09) 0.673	(14.94) 0.588
-70	(17.60) 0.693	(15.44) 0.608
-71	(21.08) 0.830	(18.92) 0.745
-72	(21.62) 0.851	(19.46) 0.766

Note:
This Series is non-standard,
non-returnable.

Note:
For added mechanical stability, Samtec recommends mechanical
board spacers be used in applications with gold or selective gold
plated connectors. Contact ipg@samtec.com for more information.

SHROUDED HEADERS

(2.00 mm) .0787" PITCH • TSH/TMMS SERIES

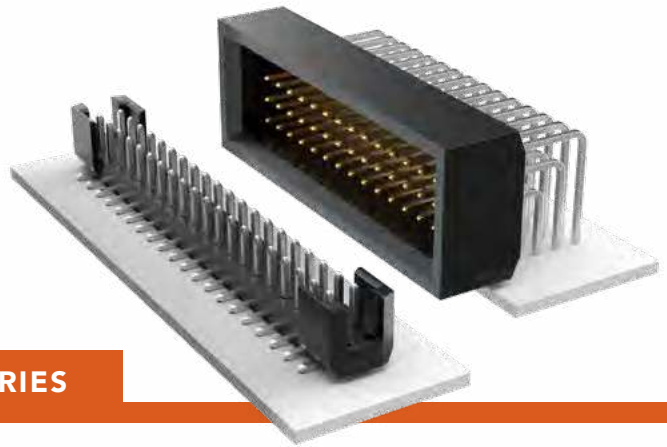

TSH

Mates:

CLT, SQT, SQW, ESQT,
TLE, SMM, MMS, PTF

TMMS

Mates:

SQT, SQW, ESQT

TSH	-	1	NO. PINS PER ROW	-	01	PLATING OPTION	-	ROW OPTION	-	OTHER OPTION
-----	---	---	------------------	---	----	----------------	---	------------	---	--------------

05, 10, 15, 20, 25,
30, 35, 40, 45
(40 & 45 = -D & -RA only)
(Standard sizes)

-F
= Gold flash on post, Matte Tin on tail

-D
= Vertical Through-hole

-LC
= Locking Clip (-DV only)
(Not available with -A)
(Manual placement required)

-L
= 10 μ" (0.25 μm) Gold on post, Matte Tin on tail

-DV
= Vertical Surface Mount

-A
= Alignment Pin (-DV only)
(Not available with -LC)

-RA
= Right-angle Through-hole

-SL
= Solder Locks (-DH only)

-T
= Matte Tin

-DH
= Horizontal Surface Mount

-K
= (4.50 mm) .177" DIA Polyimide Film Pick & Place Pad (-DH only)
(Not available with 15 - 30 positions)

-TR
= Tape & Reel

-FR
= Full Reel Tape & Reel (must order max. quantity per reel; contact Samtec for quantity breaks)

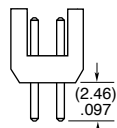
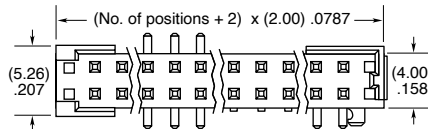

-D

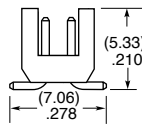

-DV

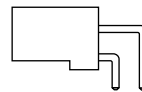

-RA

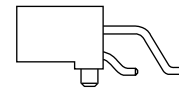

-DH

SPECIFICATIONS

Insulator Material:

Black Liquid Crystal Polymer

Terminal Material:

Phosphor Bronze

Plating:

Sn or Au over 50 μ" (1.27 μm) Ni

Operating Temp Range:

-55 °C to +105 °C with Tin;
-55 °C to +125 °C with Gold

PROCESSING

Lead-Free Solderable:

Yes

SMT Lead Coplanarity (TSH):

(0.15 mm) .006" max*
*(.004" stencil solution may be available; contact ipg@samtec.com)

ALSO AVAILABLE

MOQ Required

Other sizes
Other plating

TMMS	-	1	NO. PINS PER ROW	-	01	PLATING OPTION	-	Q	-	OPTION	-	FS
------	---	---	------------------	---	----	----------------	---	---	---	--------	---	----

05, 10, 15,
20, 30, 40, 50

-F
= Gold flash on post, Matte Tin on tail

-RA
= Right-angle

-L
= 10 μ" (0.25 μm) Gold on post, Matte Tin on tail

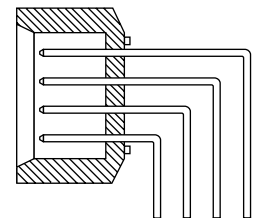
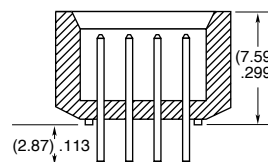
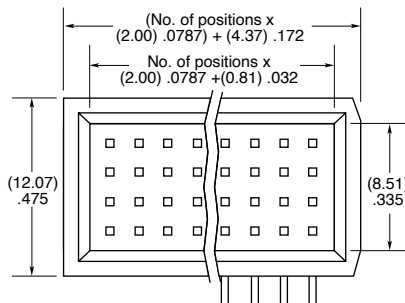

-RA

Note:

Some lengths, styles and options are non-standard, non-returnable.

SMT & THROUGH-HOLE BOARD STACKERS

(2.00 mm) .0787" PITCH • TW SERIES

CLT or MMS	SQT
8	4
G b p s	G b p s

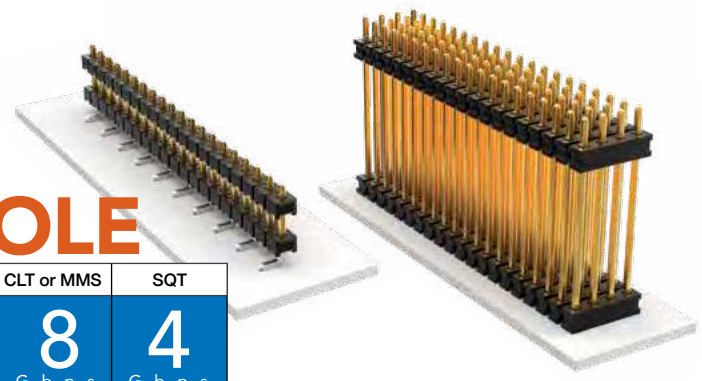

TW
Board Mates:
 CLT, SQT, SQW, ESQT,
 TLE, SMM, MMS

Cable Mates:
 TCS D

SPECIFICATIONS

Insulator Material:
 Black Liquid Crystal Polymer
Terminal Material:
 Phosphor Bronze
Plating:
 Sn or Au over
 50 μ" (1.27 μm) Ni
Current Rating:
 TW-SM = 4.9 A per pin
 (2 pins powered)
 TW-TH = 5.2 A per pin
 (2 pins powered)
Operating Temp Range:
 -55 °C to +105 °C with Tin;
 -55 °C to +125 °C with Gold

PROCESSING

Lead-Free Solderable:
 Yes
SMT Lead Coplanarity:
 (0.15 mm) .006" max*
 *(.004" stencil solution
 may be available; contact
 ipg@samtec.com)

ALSO AVAILABLE

MOQ Required

Other Platings
 End shrouds with or
 without guide post

Notes:
 For added mechanical
 stability, Samtec recommends
 mechanical board spacers be
 used in applications with gold or
 selective gold plated connectors.
 Contact ipg@samtec.com for
 more information.

This Series is non-standard,
 non-returnable.

TW	NO. PINS PER ROW	LEAD STYLE	PLATING OPTION	ROW OPTION	STACKER HEIGHT	SM	OTHER OPTION																				
	02 thru 36	Specify LEAD STYLE from chart	-F = Gold flash on post, Matte Tin on tail -L = 10 μ" (0.25 μm) Gold on post, Matte Tin on tail -T = Matte Tin	-S = Single Row -D = Double Row	- "XXX" = Stacker Height in inches (0.13 mm) .005" increments Example: -250 = (6.35 mm) .250"		- "XXX" = Polarized Position -A = Alignment Pin (Metal or plastic at Samtec discretion) (4.83 mm) .190" min. board space (-D only) -P = Pick & Place Pad (1.91 mm) .075" min. post height (04-36 only) - "X"R Specify "T" for Tape & Reel Specify "F" for Full Reel Tape & Reel (must order max. quantity per reel; contact Samtec for quantity breaks) (-07 lead style N/A) (-06 lead style with -P option N/A as standard)																				
				<table border="1"> <thead> <tr> <th>LEAD STYLE</th> <th>OAL</th> </tr> </thead> <tbody> <tr><td>-02</td><td>(7.85) .309</td></tr> <tr><td>-03</td><td>(11.86) .467</td></tr> <tr><td>-04</td><td>(12.37) .487</td></tr> <tr><td>-06</td><td>(15.37) .605</td></tr> <tr><td>-07</td><td>(17.35) .683</td></tr> <tr><td>-09</td><td>(9.86) .388</td></tr> </tbody> </table>		LEAD STYLE	OAL	-02	(7.85) .309	-03	(11.86) .467	-04	(12.37) .487	-06	(15.37) .605	-07	(17.35) .683	-09	(9.86) .388	<table border="1"> <thead> <tr> <th>ROW OPTION</th> <th>A</th> </tr> </thead> <tbody> <tr><td>-S</td><td>(5.08) .200</td></tr> <tr><td>-D</td><td>(6.35) .250</td></tr> </tbody> </table>		ROW OPTION	A	-S	(5.08) .200	-D	(6.35) .250
LEAD STYLE	OAL																										
-02	(7.85) .309																										
-03	(11.86) .467																										
-04	(12.37) .487																										
-06	(15.37) .605																										
-07	(17.35) .683																										
-09	(9.86) .388																										
ROW OPTION	A																										
-S	(5.08) .200																										
-D	(6.35) .250																										

TW	NO. PINS PER ROW	LEAD STYLE	PLATING OPTION	ROW OPTION	STACKER HEIGHT	TAIL SPEC																																	
	02 thru 50	Specify LEAD STYLE from chart	-F = Gold flash on post, Matte Tin on tail -L = 10 μ" (0.25 μm) Gold on post, Matte Tin on tail -T = Matte Tin	-S = Single Row -D = Double Row -T = Triple Row -Q = Four Row -5 = Five Row -6 = Six Row	- "XXX" = Stacker Height in inches (0.13 mm) .005" increments Example: -250 = (6.35 mm) .250"	- "XXX" = Tail Length in inches (0.13 mm) .005" increments Example: -150 = (3.81 mm) .150" - "XXX" = Polarized Position (Specify position to be removed)																																	
				<table border="1"> <thead> <tr> <th>LEAD STYLE</th> <th>OAL</th> </tr> </thead> <tbody> <tr><td>-01</td><td>(8.20) .323</td></tr> <tr><td>-02</td><td>(9.60) .377</td></tr> <tr><td>-03</td><td>(13.60) .535</td></tr> <tr><td>-04</td><td>(14.10) .555</td></tr> <tr><td>-05</td><td>(15.10) .594</td></tr> <tr><td>-06</td><td>(17.10) .673</td></tr> <tr><td>-07</td><td>(19.10) .751</td></tr> <tr><td>-08*</td><td>(21.10) .830</td></tr> <tr><td>-09</td><td>(11.60) .456</td></tr> <tr><td>-10</td><td>(15.60) .614</td></tr> <tr><td>-11</td><td>(10.08) .397</td></tr> <tr><td>-12*</td><td>(28.19) 1.110</td></tr> </tbody> </table>		LEAD STYLE	OAL	-01	(8.20) .323	-02	(9.60) .377	-03	(13.60) .535	-04	(14.10) .555	-05	(15.10) .594	-06	(17.10) .673	-07	(19.10) .751	-08*	(21.10) .830	-09	(11.60) .456	-10	(15.60) .614	-11	(10.08) .397	-12*	(28.19) 1.110	<table border="1"> <thead> <tr> <th>ROW OPTION</th> <th>STACKER HEIGHT</th> </tr> </thead> <tbody> <tr><td>-S, -D*, -Q</td><td>(3.05) .120 MIN</td></tr> <tr><td>-T, -5, -6</td><td>(4.06) .160 MIN</td></tr> </tbody> </table>		ROW OPTION	STACKER HEIGHT	-S, -D*, -Q	(3.05) .120 MIN	-T, -5, -6	(4.06) .160 MIN
LEAD STYLE	OAL																																						
-01	(8.20) .323																																						
-02	(9.60) .377																																						
-03	(13.60) .535																																						
-04	(14.10) .555																																						
-05	(15.10) .594																																						
-06	(17.10) .673																																						
-07	(19.10) .751																																						
-08*	(21.10) .830																																						
-09	(11.60) .456																																						
-10	(15.60) .614																																						
-11	(10.08) .397																																						
-12*	(28.19) 1.110																																						
ROW OPTION	STACKER HEIGHT																																						
-S, -D*, -Q	(3.05) .120 MIN																																						
-T, -5, -6	(4.06) .160 MIN																																						
				<p>*-D with stacker height greater than (4.06 mm) .160" will not have standoffs.</p>		<p>*Style -08 & -12 = S & D only</p>																																	

PRESS-FIT HEADERS & SOCKETS

(2.00 mm) .0787" PITCH • PTT/PTF SERIES

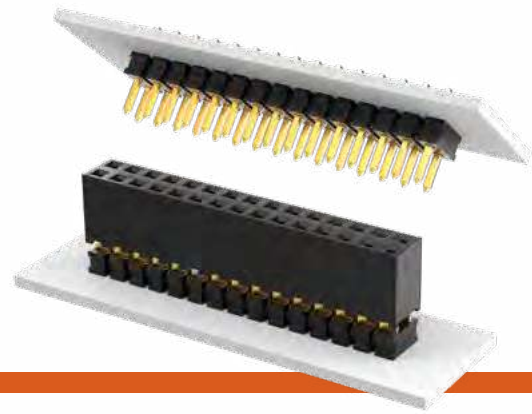

PTT
Mates:
 PTF, ESQT, PTHF,
 SQW, SQT, SMM

PTF
Mates:
 PTT, TMMH, TMM, MTMM,
 MMT, TW, LTMM, ZLTMM

SPECIFICATIONS

Insulator Material:
 Black Liquid Crystal Polymer
Contact Material:
 Phosphor Bronze
Plating:
 Au or Sn over
 50 μ" (1.27 μm) Ni
Current Rating:
 2.9 A per pin
 (2 pins powered)
Operating Temp Range:
 -55 °C to +125 °C
Insertion Depth:
 (2.67 mm) .105" to
 (3.56 mm) .140"
Max Cycles:
 100 with 30 μ" (0.76 μm) Au



-L
 = 10 μ" (0.25 μm)
 Gold contact,
 Matte Tin on tail

-S
 = Single Row
-D
 = Double Row

-"XXX"
 = Polarized
 Position

ROW OPTION	A
-S	(2.00) .079
-D	(4.00) .158
-T	(6.00) .236
-Q	(8.00) .314
-5	(10.00) .393
-6	(12.00) .472

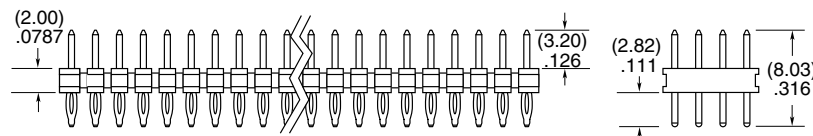
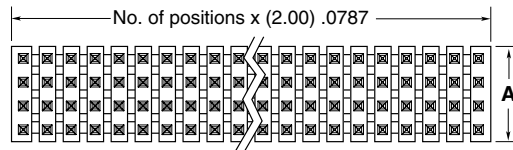

ALSO AVAILABLE

MOQ Required

Other Platings

TOOLING

Press-Fit
 PHT: CAT-PT-PH-1XX-X-X
 PHF: CAT-PT-PH-1XX-X-B
 For more information,
 visit www.samtec.com/tooling



Specify
**LEAD
 STYLE**
 from
 chart

-L
 = 10 μ" (0.25 μm)
 Gold on post,
 Matte Tin on tail

-"XXX"
 = Polarized
 Position

LEAD STYLE	A
-01	(6.35) .250
-03	(9.14) .360

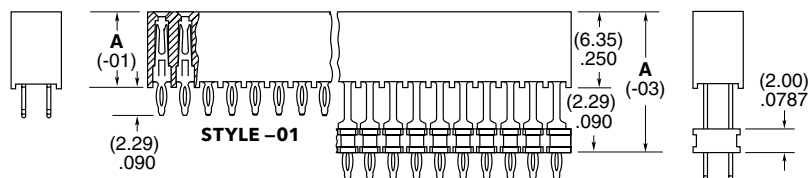
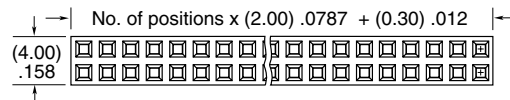

Note:
 Some lengths, styles and
 options are non-standard,
 non-returnable.

FLEXIBLE ELEVATED & SELF-NESTING SOCKETS

(2.00 mm) .0787" PITCH • ESQT/ESQT (-368)/PTHF SERIES

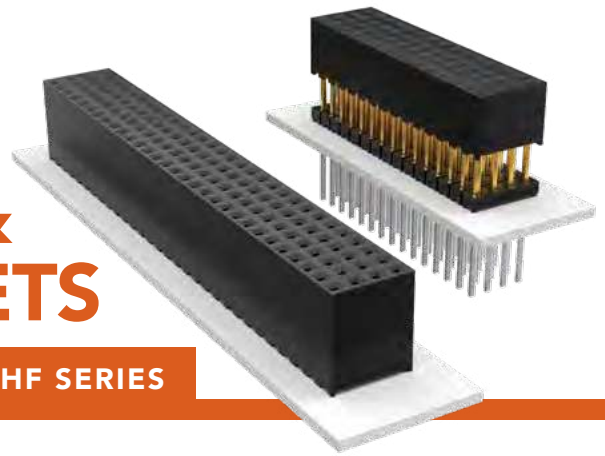

ESQT

Board Mates:
TMMH, TMM, MTMM, MMT, TW, LTMM, ZLTMM, ESQT, PTT, TSH, TMMS

Cable Mates:
TCMD

SPECIFICATIONS

Insulator Material:
Black Liquid Crystal Polymer

Contact Material:
Phosphor Bronze

Plating:
Sn or Au over 50 μ" (1.27 μm) Ni

Current Rating (ESQT/TMMH):
4.5 A per pin (2 pins powered)

Operating Temp Range:
-55 °C to +125 °C

Insertion Depth:
(2.62 mm) .103" to (5.03 mm) .198" with (0.38 mm) .015" wipe

Max Cycles:
100 with 10 μ" (0.25 μm) Au

Lead-Free Solderable:
Yes, for -S, -D & -Q (Wave only for -T, -5 & -6)

ESQT	1	NO. PINS PER ROW	LEAD STYLE	PLATING OPTION	ROW OPTION	BODY HEIGHT	OTHER OPTION
------	---	------------------	------------	----------------	------------	-------------	--------------

02 thru 50

Specify LEAD STYLE from chart

-F
= Gold flash on contact, Matte Tin on tail

-L
= 10 μ" (0.25 μm) Gold on contact, Matte Tin on tail

-M
= 20 μ" (0.51 μm) Gold on contact, Matte Tin on tail

-GF
= 15 μ" (0.38 μm) Gold on contact, Gold flash on tail (Recommended for self-nesting) (-02 lead style only)

-S
= Single Row

-D
= Double Row

-T
= Triple Row

-Q
= Quad Row

-5
= Five Row

-6
= Six Row

"XXX"
= Body Height (in inches)

(7.87 mm) .310" minimum for -S, -D, -Q

(9.53 mm) .375" minimum for -T, -5, -6

"XXX"
= Polarized Position (Indicate position number)

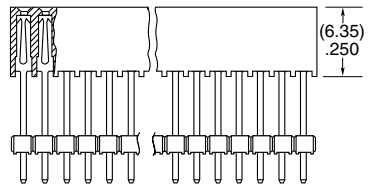
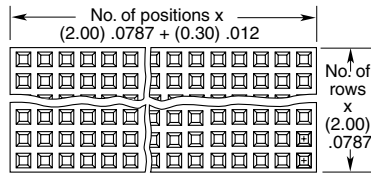

LEAD STYLE	A	MAX TAIL	MAX BODY HEIGHT
-02	(21.59) .850	(13.72) .540	(20.32) .800
-03	(11.63) .458	(3.76) .148	(10.36) .408

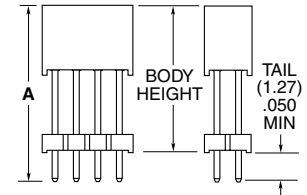

ESQT (-368)/PTHF

Mates:
ESQT, PTHF

SPECIFICATIONS

Insulator Material:
Black Liquid Crystal Polymer (ESQT-368)
Black High Temp Nylon (PTHF)

Contact Material:
Phosphor Bronze

Plating:
Au or Sn over 50 μ" (1.27 μm) Ni

Operating Temp Range:
-55 °C to +125 °C

Max Cycles:
100 with 10 μ" (0.25 μm) Au

Lead-Free Solderable:
Yes (ESQT-368)

SERIES	1	NO. PINS PER ROW	LEAD STYLE	PLATING OPTION	Q	368
--------	---	------------------	------------	----------------	---	-----

ESQT
= Solder Tails

PTHF
= Press-fit Tails

Specify LEAD STYLE from chart

-GF
= 15 μ" (0.38 μm) Gold on contact, Gold flash on tail (-02 Lead Style only)

-M
= 20 μ" (0.51 μm) Gold on contact, Matte Tin on tail (-03 Lead Style only)

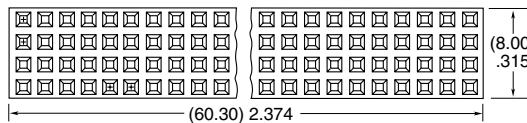
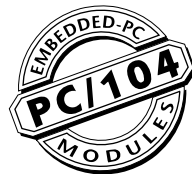

LEAD STYLE	ESQT		PTHF	
	A	B	A	B
-02	(21.59) .850	(12.24) .482	(21.59) .850	(12.24) .482
-03	(11.63) .458	(2.29) .090	(12.34) .486	(3.00) .118

TOOLING

Press-Fit
CAT-PT-130-A-4
For more information, visit www.samtec.com/tooling

Note:
This Series is non-standard, non-returnable.

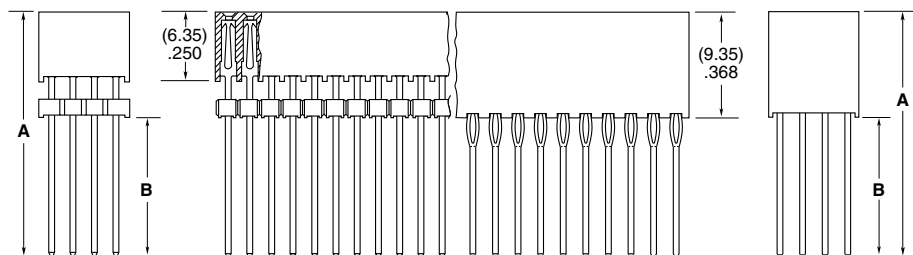

ESQT (-368) SERIES

PTHF SERIES

COST-EFFECTIVE RUGGED SOCKETS

(2.00 mm) .0787" PITCH • SQW/SQT SERIES

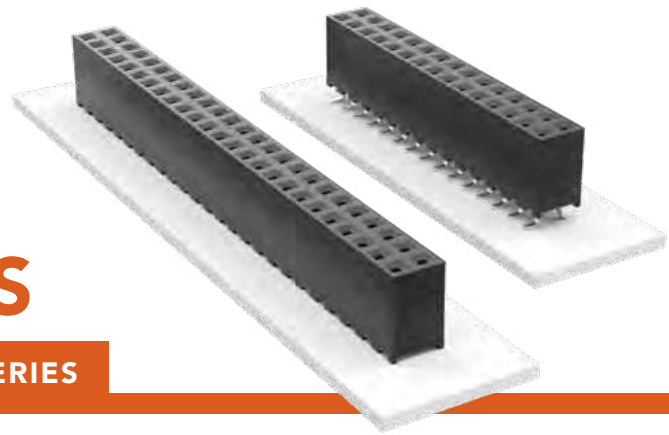

SQW/SQT

Board Mates:

TMMH, TMM5, TMM, MTMM, MMT, TW, TSH, LTMM, ZLTMM, PTT

Cable Mates:

TCMD

SPECIFICATIONS

Insulator Material:

Black Liquid Crystal Polymer

Contact Material:

Phosphor Bronze

Plating:

Sn or Au over
50 μ" (1.27 μm) Ni

SQW Current Rating

(SQW/TMMH):
3.8 A per pin (2 pins powered)

SQT Current Rating

(TMMH/SQT):
5.1 A per pin (2 pins powered)

Voltage Rating:

281 VAC mated with TMM;
250 VAC mated with TMMH

Operating Temp Range:

-55 °C to +125 °C

SQW Insertion Depth:

(2.62 mm) .103" to

(5.03 mm) .198" with

(0.38 mm) .015" wipe

SQT Insertion Depth:

(2.62 mm) .103" to

(5.03 mm) .198"

Max Cycles:

100 with 10 μ" (0.25 μm) Au

SQW	-	1	NO. PINS PER ROW	-	01	PLATING OPTION	-	ROW OPTION	-	OPTION
------------	---	----------	-------------------------	---	-----------	-----------------------	---	-------------------	---	---------------

02 thru 50

-F

= Gold flash on contact, Matte Tin on tail

-L

= 10 μ" (0.25 μm) Gold on contact, Matte Tin on tail

-D

= Double Row

-D-VS

= Double Row Surface Mount

-T

= Triple Row

-Q

= Four Row

-5

= Five Row

-6

= Six Row

-"XXX"

= Polarized Position
-D-VS only options:

-A

= Alignment Pin (5 positions minimum)
Metal or plastic at Samtec discretion. (Not available with -LC)

-LC

= Locking Clip (5 positions minimum)
(Manual placement required)

-K

= (4.25 mm) .167" DIA Polyimide Film Pick & Place Pad (4 positions minimum)

-P

= Pick & Place Pad (4 positions minimum)

-TR

= Tape & Reel (4-28 positions only)

-FR

= Full Reel Tape & Reel (must order max. quantity per reel; contact Samtec for quantity breaks) (4-28 positions only)

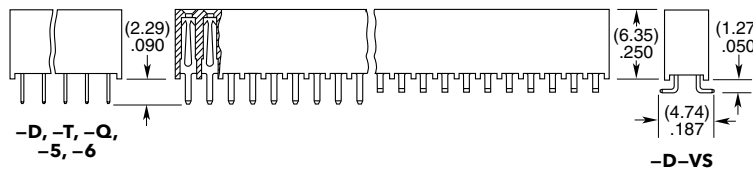
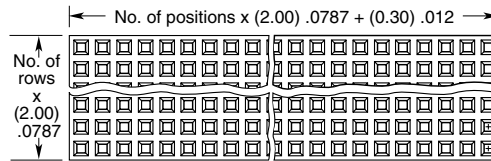

PROCESSING

SQW Lead-Free Solderable:

Yes, for -D & -D-VS

(Wave only for -T, -Q, -5 & -6)

SQT Lead-Free Solderable:

Yes

SMT Lead Coplanarity:

(0.10 mm) .004" max (02-10)

(0.15 mm) .006" max (11-50)*

*(.004" stencil solution may be available; contact

ipg@samtec.com)

SQT	-	1	NO. PINS PER ROW	-	LEAD STYLE	-	PLATING OPTION	-	ROW OPTION	-	OTHER OPTION
------------	---	----------	-------------------------	---	-------------------	---	-----------------------	---	-------------------	---	---------------------

02 thru 50

Specify LEAD STYLE from chart

-F

= Gold flash on contact, Matte Tin on tail

-L

= 10 μ" (0.25 μm) Gold on contact, Matte Tin on tail

-S

= Single Row

-D

= Double Row

-T

= Triple Row

-Q

= Four Row

-5

= Five Row

-6

= Six Row

-RA

= Right-angle (-Q, -5 & -6 Row not available) (Lead Style -01 only)

-"XXX"

= Polarized Position (Indicate position number)

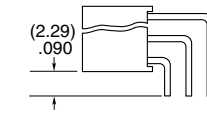
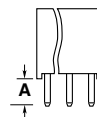
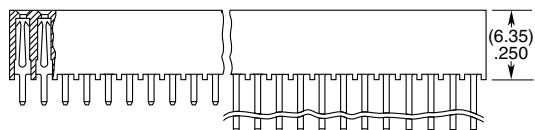

-RA OPTION (-Q, -5 & -6 not available)

Note:

Some lengths, styles and options are non-standard, non-returnable.

TIGER CLAW™ SOCKET STRIP

(2.00 mm) .0787" PITCH • MMS SERIES

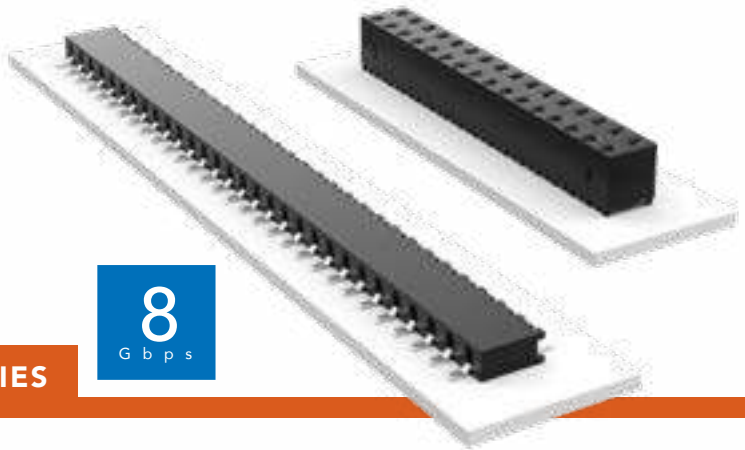

MMS

Board Mates:
TMMH, TMM, MTMM, MMT,
TW, LTMM, ZLTMM, TSH

Cable Mates:
TCMD

MMS	1	NO. PINS PER ROW	01	PLATING OPTION	ROW OPTION	OPTION
------------	----------	-------------------------	-----------	-----------------------	-------------------	---------------

02 thru 40

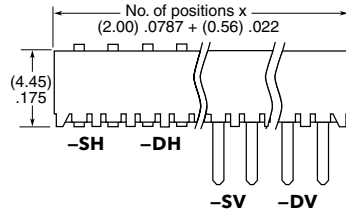
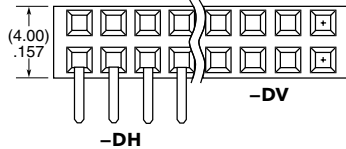
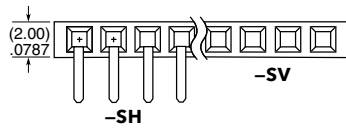

-F
= Gold flash on contact,
Matte Tin on tail

-L
= 10 μ" (0.25 μm)
Gold contact,
Matte Tin on tail

-SV
= Single
Vertical

-SH
= Single
Horizontal

-DV
= Double
Vertical

-DH
= Double
Horizontal

-XX
= Polarized
Position

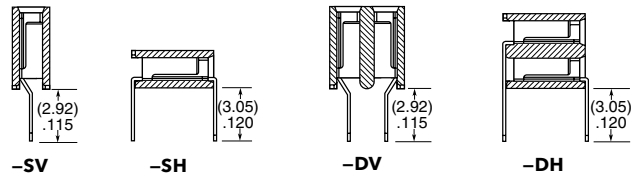

SPECIFICATIONS

Insulator Material:
Black LCP

Contact Material:
Phosphor Bronze

Plating:
Sn or Au over
50 μ" (1.27 μm) Ni

Current Rating (MMS/TMM):
3.9 A per pin
(2 pins powered)

Operating Temp Range:
-55 °C to +125 °C with Gold
-55 °C to +105 °C with Tin

Insertion Depth:
DH = (2.13 mm) .084" to
(2.79 mm) .110"
SH = (2.13 mm) .084"
minimum or pass-through
Top Entry DV/SV =
(2.13 mm) .084" to
(4.32 mm) .170"
Bottom Entry DV/SV =
(4.27 mm) .168" minimum
(Plus board)

PROCESSING

Lead-Free Solderable:
Yes

SMT Lead Coplanarity:
(0.15 mm) .006" max*
*(.004" stencil solution
may be available; contact
ipg@samtec.com)

MMS	1	NO. PINS PER ROW	02	PLATING OPTION	ROW OPTION	OTHER OPTION
------------	----------	-------------------------	-----------	-----------------------	-------------------	---------------------

02 thru 40

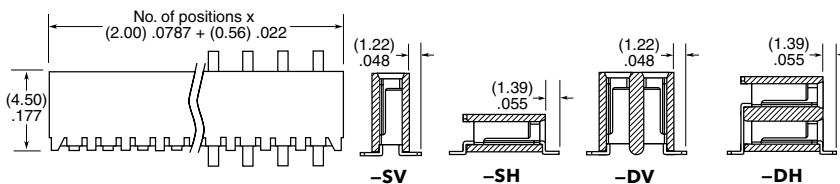
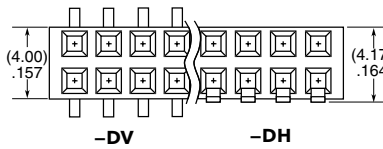
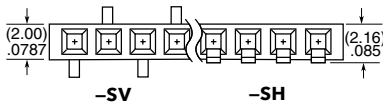

-F
= Gold flash
on contact,
Matte Tin on tail

-L
= 10 μ" (0.25 μm)
Gold contact,
Matte Tin on tail

-SV
= Single
Vertical

-SH
= Single
Horizontal

-DV
= Double
Vertical

-DH
= Double
Horizontal

-XX
= Polarized Position

-K
= (5.50 mm) .217" DIA
Polyimide Film
Pick & Place Pad
(3 positions min.)
(-SV & -DV only)

-M
= Metal Pick & Place Pad
(4 positions min.)
(-DV only)

-P
= Plastic Pick & Place Pad
(4 positions min.)
(-SV & -DV only)

-TR
= Tape & Reel



-FR
= Full Reel
Tape & Reel
(must order max.
quantity per reel;
contact Samtec for
quantity breaks)

ALSO AVAILABLE

MOQ Required

Alignment Pin (-DV only)
Locking clips and Through-hole
pass-through options
Other platings

Note:
Some lengths, styles and
options are non-standard,
non-returnable.

COST-EFFECTIVE & DUAL WIPE SOCKETS

(2.00 mm) .0787" PITCH • TLE/CLT SERIES

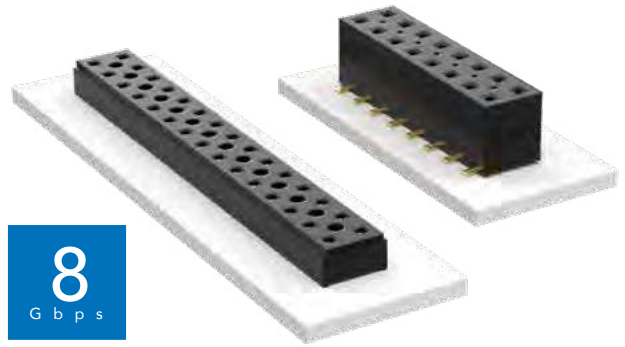

TLE

Mates:
TMMH, TMM, MTMM,
MMT, TW, LTMM, ZLTMM,
TCMD, TSH

CLT

Mates:
TMM, TMMH, MTMM,
MMT, TW, TSH

SPECIFICATIONS

TLE

Insulator Material:
Black Liquid Crystal Polymer
Contact Material:
Phosphor Bronze
Plating:
Au over 50 μ" (1.27 μm) Ni
Current Rating (TLE/TMMH):
3.2 A per pin
(2 pins powered)
Operating Temp Range:
-55 °C to +125 °C
Insertion Depth:
(2.08 mm) .082" to
(4.37 mm) .172" with
(0.38 mm) .015" wipe,
pass-through, or
(3.35 mm) .132" min
for bottom entry

CLT

Same as TLE except:
Plating:
Sn or Au over 50 μ" (1.27 μm) Ni
Current Rating (TMMH/CLT):
4.1 A per pin
(2 pins powered)
Insertion Depth:
Top Entry=
(1.40 mm) .055" minimum
Bottom Entry=
(2.57 mm) .101" minimum
(add board thickness for
correct post OAL)
Max Cycles:
100 with 10 μ" (0.25 μm) Au

PROCESSING

TLE

Lead-Free Solderable:
Yes
SMT Lead Coplanarity:
(0.10 mm) .004" max (02-26)
(0.15 mm) .006" max (27-50)*
*(.004" stencil solution
may be available; contact
ipg@samtec.com)

CLT

Same as TLE except:
SMT Lead Coplanarity:
(0.10 mm) .004" max (02-25)
(0.15 mm) .006" max (26-34)*
(0.20 mm) .008" max (35-50)*
*(.004" stencil solution
may be available; contact
ipg@samtec.com)

Note:
Some lengths, styles and
options are non-standard,
non-returnable.

TLE	- 1	NO. PINS PER ROW	- 01	PLATING OPTION	- DV	OPTIONS
-----	-----	------------------	------	----------------	------	---------



02 thru 50

-G
= 10 μ" (0.25 μm)
Gold

-A
= Alignment Pin
(3 positions minimum)

-K
= (5.00 mm) .197" DIA
Polyimide Film Pick & Place Pad
(3 positions minimum)

-P
= Metal Pick & Place Pad
(4 positions minimum)

-TR
= Tape & Reel Packaging
(2-37 positions only)

-FR
= Full Reel Tape & Reel
(must order maximum
quantity per reel; contact
Samtec for quantity breaks)
(2-37 positions only)

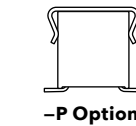
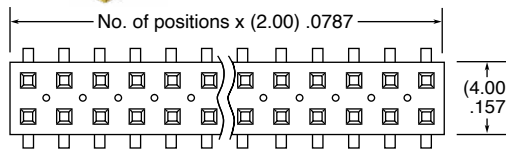

-P Option



-A Option

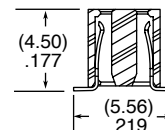

CLT	- 1	NO. PINS PER ROW	- LEAD STYLE	PLATING OPTION	- D	OTHER OPTIONS
-----	-----	------------------	--------------	----------------	-----	---------------



02 thru 50

-01
= Through-hole

-F
= Gold flash
on contact,
Matte Tin on tail

All options require
Style -02

-BE
= Bottom Entry
(Required for bottom
entry applications)

-A
= Alignment Pin
(3 positions minimum)
Metal or plastic at
Samtec's discretion

-K
= (5.00 mm) .197" DIA
Polyimide Film
Pick & Place Pad
(04 thru 50 only)

-P
= Pick & Place Pad
(4 positions minimum)
(Not always necessary
for auto placement.)

-TR
= Tape & Reel
(36 positions max)

-FR
= Full Reel Tape & Reel
(must order maximum
quantity per reel;
contact Samtec for
quantity breaks)
(36 positions max)

ALSO AVAILABLE
MOQ Required

Other Platings

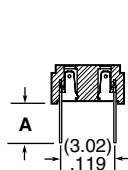
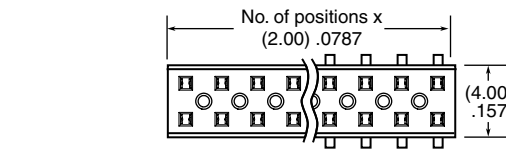

-01 or -03

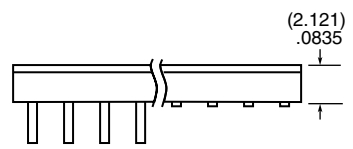

LEAD STYLE	A
-01	(2.16) .085
-03	(2.95) .116

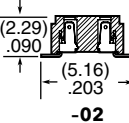

-02

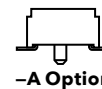

-A Option

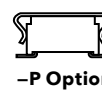

-P Option

SELF MATING HERMAPHRODITIC STRIP

(2.00 mm) .0787" PITCH • LS2 SERIES

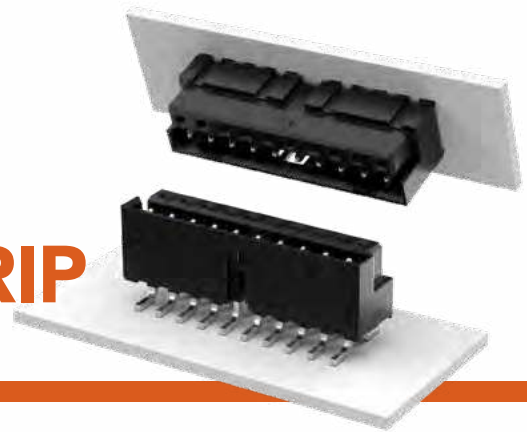

LS2
Mates:
LS2

LS2	1	NO. PINS PER ROW	LEAD STYLE	PLATING OPTION	D	TAIL OPTION	OPTION
-----	---	------------------	------------	----------------	---	-------------	--------

05, 10, 15,
20, 25, 30

-01
= Through-hole

-02
= Surface Mount

-F
= Gold flash on contact,
Matte Tin on tail

-L
= 10 μ" (0.25 μm)
Gold on contact,
Matte Tin on tail

-01 only

-RA1
= Right-angle
(Shroud Down)

-RA2
= Right-angle
(Shroud Up)

-K
= (6.30 mm)
.248" DIA
Polyimide
Film Pick &
Place Pad
(-02 only)

-TR
= Tape &
Reel

-FR
= Full Reel
Tape & Reel
(must order
max. quantity
per reel;
contact
Samtec for
quantity
breaks)

SPECIFICATIONS

Insulator Material:
Black Liquid Crystal
Polymer
Contact Material:
Phosphor Bronze
Plating:
Au or Sn over
50 μ" (1.27 μm) Ni
Current Rating:
3.2 A per pin
(6 adjacent pins powered)
Voltage Rating:
475 VAC mated with LS2
Operating Temp Range:
-55 °C to +125 °C

PROCESSING

Lead-Free Solderable:
Yes
SMT Lead Coplanarity:
(0.15 mm) .006" max*
*(.004" stencil solution
may be available; contact
ipg@samtec.com)

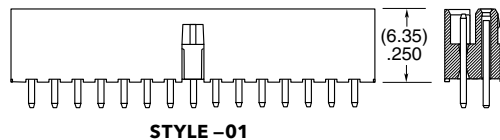
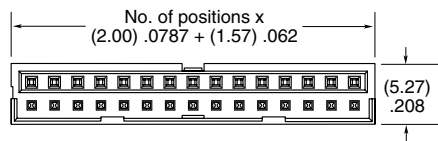
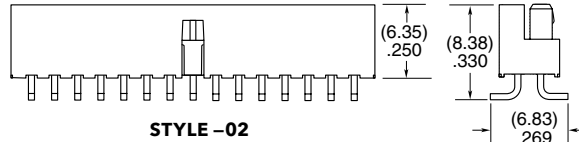
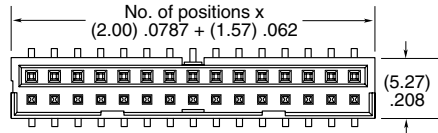

APPLICATION

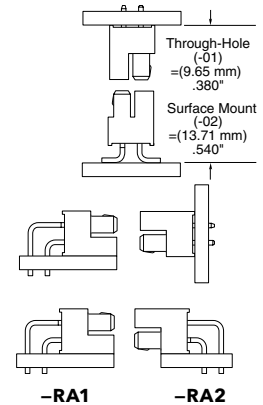

ALSO AVAILABLE

MOQ Required

Alignment pin
Other platings
Other stack heights

Note:
Some lengths, styles and
options are non-standard,
non-returnable.

PRESS-FIT HEADERS & SOCKETS

(2.54 mm) .100" PITCH • PHT/PHF SERIES

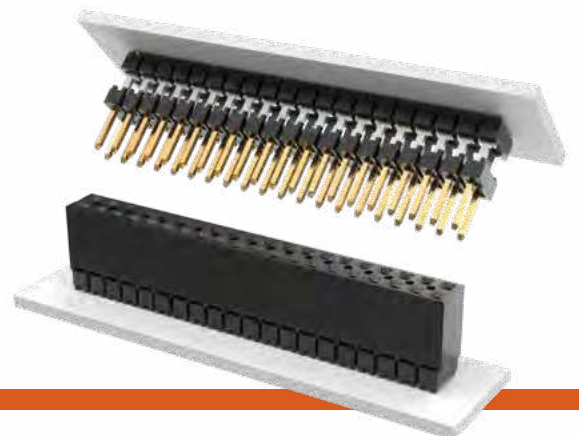

PHT

Board Mates:
SSW, SSQ, ESW,
ESQ, BCS, BSW,
CES, SLW, PHF, SSM

Cable Mates:
IDSJ, IDSS

PHF

Board Mates:
TSW, MTSW, MTLW,
EW, ZW, TSS, ZSS,
TSM, TSSH, PHT, DW, HW

SPECIFICATIONS

Insulator Material:
Liquid Crystal Polymer
Contact Material:
Phosphor Bronze
Plating:
Au or Sn over
50 μ " (1.27 μ m) Ni
Current Rating (PHT/PHF):
4.8 A per pin
(2 pins powered)
Operating Temp Range:
-55 °C to +125 °C with Gold
(PHF) **Insertion Depth:**
(3.68 mm) .145" to
(6.35 mm) .250"



NO. PINS PER ROW
01
= (single row only)
02 thru 50

LEAD STYLE
Specify
LEAD
STYLE
from
chart

PLATING OPTION
-L
= 10 μ " (0.25 μ m)
Gold on post,
Matte Tin on tail

ROW OPTION
-S
= Single
Row
-D
= Double
Row

OTHER OPTION
-"XXX"
= Polarized
Position

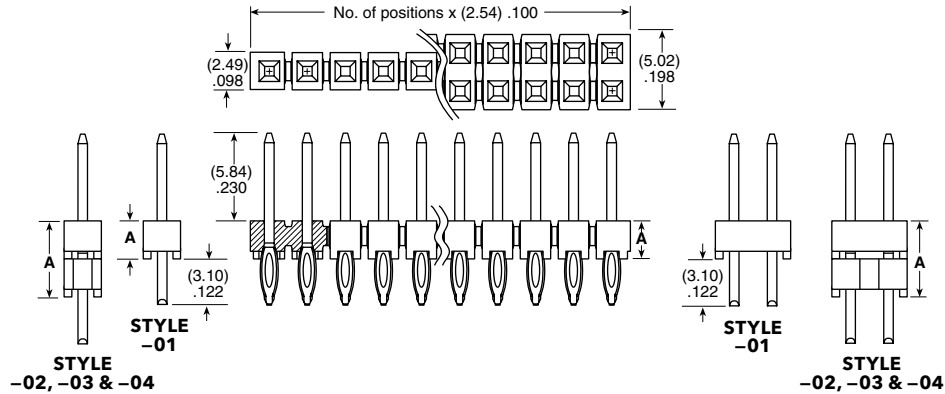

LEAD STYLE	A
-01	(2.54) .100
-02	(5.08) .200
-03	(7.62) .300
-04	(10.16) .400

PROCESSING

Contact ipg@samtec.com



NO. PINS PER ROW
01
= (single row only)
02 thru 50

LEAD STYLE
Specify
LEAD
STYLE
from
chart

PLATING OPTION
-L
= 10 μ " (0.25 μ m)
Gold on post,
Matte Tin on tail

ROW OPTION
-S
= Single
Row
-D
= Double
Row

OTHER OPTION
-"XXX"
= Polarized
Position

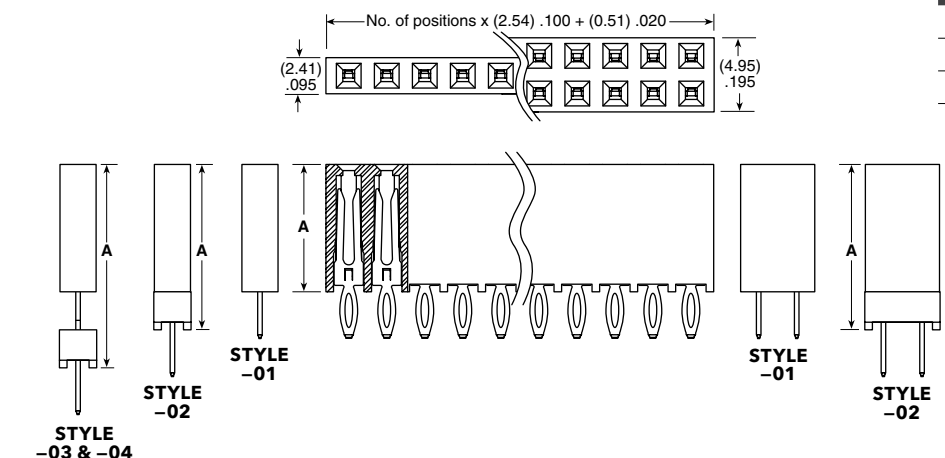

LEAD STYLE	A
-01	(8.50) .335
-02	(11.05) .435
-03	(13.59) .535
-04	(16.13) .635

ALSO AVAILABLE

Other Platings
(MOQ Required)

TOOLING

Press-Fit
PHT: CAT-PT-PH-1XX-X-X
PHF: CAT-PT-PH-1XX-X-B
For more information, visit
www.samtec.com/tooling

Note:
Some lengths, styles and
options are non-standard,
non-returnable.

THROUGH-HOLE .025" SQ POST HEADER

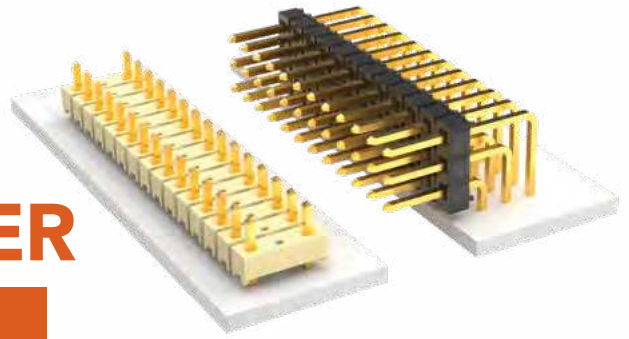

(2.54 mm) .100" PITCH • TSW/HTSW SERIES

TSW/HTSW

Board Mates:

SSW, SSQ, SSM, ESW, ESQ,
BCS, BSW, CES, SLW

Cable Mates:

IDSD, IDSS

SPECIFICATIONS

Insulator Material:

TSW: PBT

HTSW: Natural LCP

Terminal Material:

Phosphor Bronze

Plating:

Au or Sn over 50 μm (1.27 μm) Ni

Operating Temp Range:

-55 °C to +125 °C with Gold

-55 °C to +105 °C with Tin

Voltage Rating:

550 VAC mated with SSW;

500 VAC mated with BCS;

515 VAC mated with ESQ;

450 VAC -RA/-RE mated

with BCS or SSM;

400 VAC mated with CES

Lead-Free Solderable:

HTSW: Yes

TSW: No, Lead Wave Only

CURRENT RATING (PER PIN)

TSW mated with

ESW	SSW	SLW	SSQ	SSM	BCS	SNT
5.2 A	5.7 A	5.2 A	6.3 A	5.2 A	4.6 A	4.3 A

2 POSITIONS POWERED

ALSO AVAILABLE

MOQ Required

Other Platings

OTHER SOLUTIONS

Elevated Right-angle option

Shunts

Note:

Some lengths, styles and options are non-standard, non-returnable.

SERIES

TSW

= Standard Strip

HTSW

= Hi-Temp Strip

PIN CENTERS

-1

= .100" (2.54 mm) Centers,
(All positions filled)

-2

= .200" (5.08 mm) Centers,
(Every other position filled)

NO. PINS PER ROW

01 thru 50

= .100" (2.54 mm)
Center Version

02 thru 25

= .200" (5.08 mm)
Center Version

LEAD STYLE

Specify
LEAD STYLE
from chart

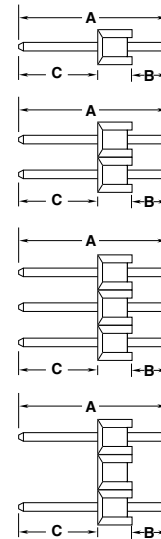
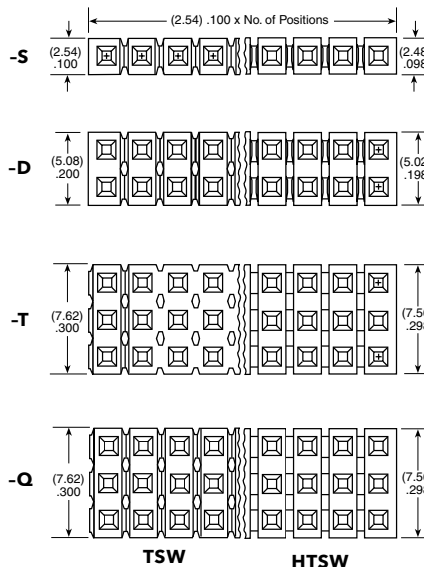

TSW

HTSW

Straight Pin Versions

STRAIGHT PIN VERSIONS

LEAD STYLE	A	B	C
*-05	(8.51) .335	(3.30) .130	(2.67) .105
*-06	(7.62) .300	(2.41) .095	(2.67) .105
*-07	(10.92) .430	(2.54) .100	
*-08	(13.46) .530	(5.08) .200	
-09	(18.54) .730	(10.16) .400	
-10	(21.08) .830	(12.70) .500	(5.84) .230
-11	(23.62) .930	(15.24) .600	
-12	(26.16) 1.030	(17.78) .700	
-13	(31.24) 1.230	(22.86) .900	
-14	(13.46) .530		(8.13) .320
*-15	(18.54) .730	(2.79) .110	(13.21) .520
*-16		(7.87) .310	(8.13) .320
*-17	(21.08) .830		(15.74) .620
*-18	(23.62) .930	(2.79) .110	(18.29) .720

* Available with -LL (Locking Lead) Option

Specify -07 for best mate with IDXX Series IDC Cable

STRAIGHT PIN VERSIONS

LEAD STYLE	A	B	C
*-19	(26.16) 1.030		(20.83) .820
*-20	(31.24) 1.230	(2.79) .110	(25.91) 1.020
*-21	(36.32) 1.430	(2.79) .110	(30.99) 1.220
*-22	(16.00) .630	(7.62) .300	
*-23	(11.30) .445		(5.84) .230
*-24	(12.15) .480	(2.92) .115	(6.73) .265
*-25	(16.00) .630	(5.33) .210	(8.13) .320
▲-26	(11.58) .456	(3.20) .126	
-27	(33.78) 1.330	(25.40) 1.000	(5.84) .230
-28	(28.70) 1.130	(20.32) .800	
-29	(33.78) 1.330	(23.11) .910	(8.13) .320
-30	(28.70) 1.130	(18.03) .710	
+41	(9.27) .365	(0.89) .035	(5.84) .230
+42	(11.94) .470	(1.27) .050	(8.13) .320

† Style -41 & -42 available with HTSW only.

▲ Except: Style -26 (0.46) .018 DIA Tail

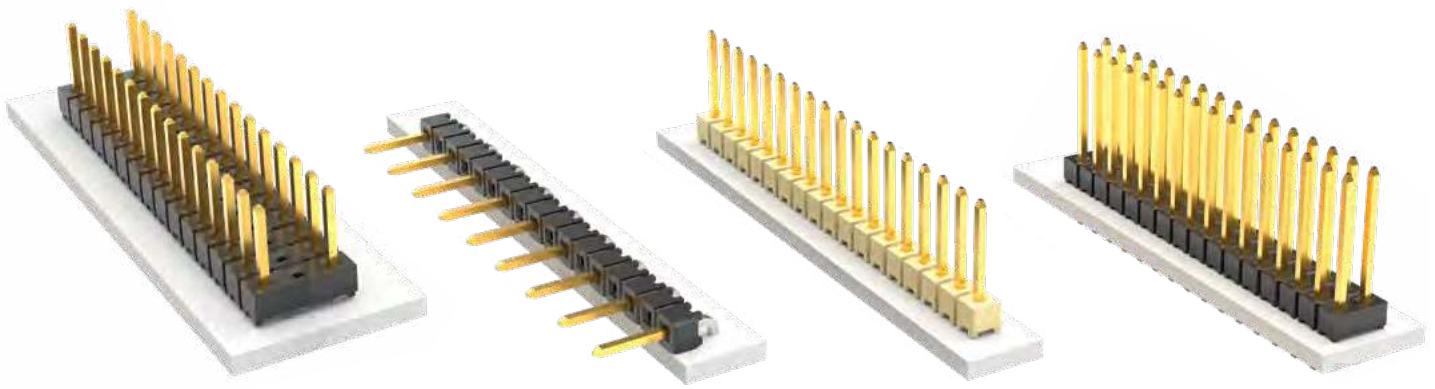

PLATING OPTION

- F**
= Gold flash on post, Matte Tin on tail
- L**
= 10 μ " (0.25 μ m) Gold on post, Matte Tin on tail
- G**
= 10 μ " (0.25 μ m) Gold on post, Gold flash on balance
- T**
= Matte Tin

ROW OPTION

- S**
= Single Row
- D**
= Double Row
- T**
= Triple Row
- Q**
= Double Row
(5.08 mm).200" row space

OTHER OPTION

- RA or -RE**
= Right-angle
- NA**
= Right-angle
(Using straight body for coplanar mating with SSW-RA series)
- LL**
= Locking Lead
See charts for available styles.
Not available with single row
1 or 2 positions.
Recommended hole size
(1.02 mm \pm 0.03 mm) .040" \pm .001)
- LC**
= Locking Clip
(Styles -08 thru -13 & -22 only)
(Requires 4 pin minimum)
(Not available with T, -Q, -RA or -RE)
- LA**
= -RA Option with -LL Option
- "XXX"**
= Polarized Position

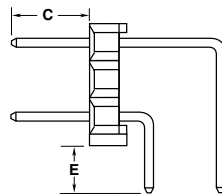
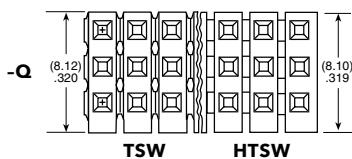
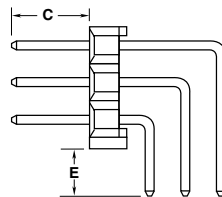
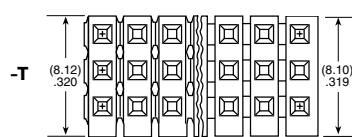
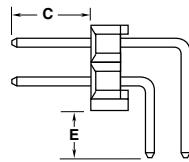
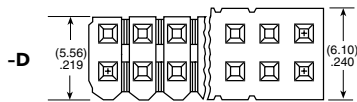
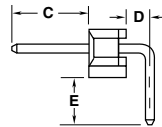
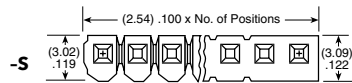

Right-Angle Versions

LEAD STYLE	D
-RA	(1.52) .060
-RE	(4.06) .160

RIGHT-ANGLE VERSIONS		
-RE LEAD STYLE	C	SINGLE E
-09		(4.83) .190
-10		(7.37) .290
-11	(5.84) .230	(9.91) .390
-12		(12.45) .490
-13		(17.53) .690
-16	(8.13) .320	(2.54) .100
-21		(22.61) .890
-22	(5.84) .230	(2.29) .090
-27		(20.07) .790
-28		(14.99) .590

-RA LEAD STYLE	RIGHT-ANGLE VERSIONS			
	SINGLE (-S)		DOUBLE (-D)	TRIPLE (-T & -Q)
	C	E	E	E
-08		(2.29) .090	(2.29) .090	(2.29) .090
-09		(7.37) .290	(7.37) .290	(7.37) .290
-10	(5.84) .230	(9.91) .390	(9.91) .390	(9.91) .390
-11		(12.45) .490	(12.45) .490	(12.45) .490
-12		(14.99) .590	(14.99) .590	(14.99) .590
-13		(20.07) .790	(20.07) .790	N/A
*-16	(8.13) .320	(5.08) .200	(5.08) .200	(5.08) .200
-21	(5.84) .230	(25.15) .990	N/A	N/A
*-22		(4.83) .190	(4.83) .190	(4.83) .190
*-25	(8.13) .320	(2.54) .100	(2.54) .100	(2.54) .100
-27	(5.84) .230	(22.61) .890	N/A	N/A
-28		(17.53) .690	(17.53) .690	
-29		(20.32) .800	N/A	
-30	(8.13) .320	(15.24) .600	(15.24) .600	

* Available with -LA (Locking Lead) Option

SURFACE MOUNT .025" SQ POST HEADER

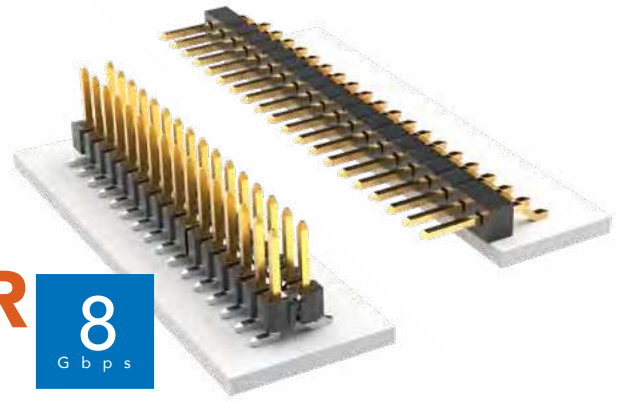

(2.54 mm) .100" PITCH • TSM SERIES

TSM

Board Mates:

SSW, SSQ, SSM, BSW, ESW, ESQ, BCS, SLW, CES, HLE

Cable Mates:

IDSS, IDSD



02 thru 36

Specify
LEAD STYLE
from chart

SPECIFICATIONS

Insulator Material:

Black Liquid Crystal Polymer

Terminal Material:

Phosphor Bronze

Plating:

Au or Sn over

50 μ m (1.27 μ m) Ni

Operating Temp Range:

-55 °C to +105 °C with Tin;

-55 °C to +125 °C with Gold

Voltage Rating:

495 VAC -SV/-DV

mated with the BCS

475 VAC -SV/-DV

mated with the SSM

PROCESSING

Lead-Free Solderable:

Yes

-DH/-SH/-SV Lead Coplanarity:

(0.15 mm) .006" max (02-36)*

-DV Lead Coplanarity:

(0.10 mm) .004" max (02-05)

(0.13 mm) .005" max (06-10)*

(0.15 mm) .006" max (11-36)*

*(.004" stencil solution may be available; contact ipg@samtec.com)

MATES	CURRENT RATING (PER PIN)
TSM/SSW	4.7 A
TSM/SSM	5.4 A
TSM/HLE	4.1 A
TSM/BCS	5.0 A

2 POSITIONS POWERED

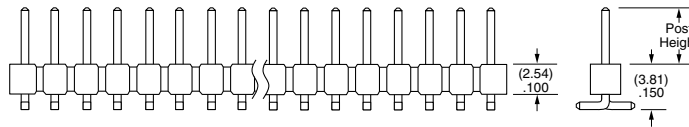
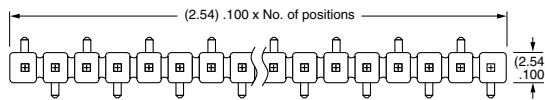

-SV Row Option

LEAD STYLE	POST HEIGHT	MATES WITH
-01	(5.84) .230	SSW, BCS, SSM, IDSS, IDSD
-02	(8.13) .320	SSM -DH
-03	(10.67) .420	Bottom Mount & Pass Through
-04	(3.05) .120	SLW, CES, HLE

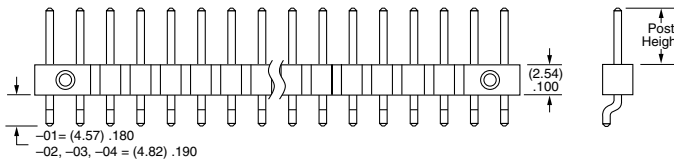
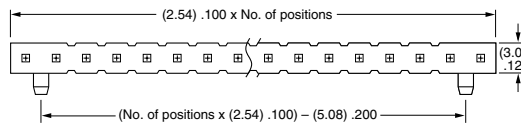

-01 = (4.57) .180
-02, -03, -04 = (4.82) .190

-SH Row Option

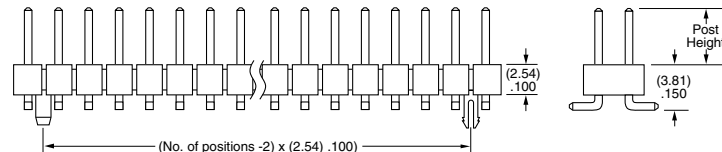
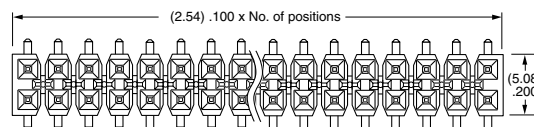

-DV Row Option

Notes:

Severe Environment Testing qualified; aligns with MIL-DTL-55302. Visit samtec.com/set

Some sizes, styles and options are non-standard, non-returnable.

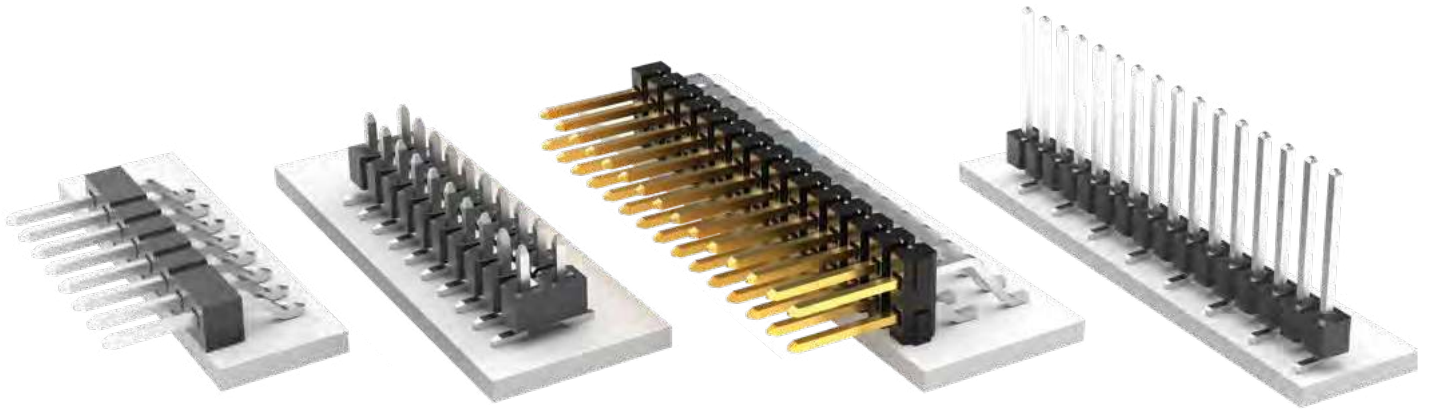

PLATING OPTION

- F**
= Gold flash on post, Matte Tin on tail
- L**
= 10 μ " (0.25 μ m) Gold on post, Matte Tin on tail
- S**
= 30 μ " (0.76 μ m) Gold on post, Matte Tin on tail
- T**
= Matte Tin

ROW OPTION

- SV**
= Single Row Vertical Pin
- DV**
= Double Row Vertical Pin
- SH**
= Single Row Horizontal Pin
- DH**
= Double Row Horizontal Pin (Style -01, -02 or -03 only)
- TM**
= Triple Row Vertical Mixed Technology (Style -01 only) (02 thru 30 positions only)
- MT**
= Mixed Technology Pin (Style -01, -02 or -03 only)

OTHER OPTIONS

- "XXX"**
= Polarized Position
- A**
= Alignment Pin
metal or plastic at Samtec discretion (Not available with -TM or -MT) (02 positions minimum) (Not available with -LC)
- LC**
= Locking Clip
(Not available with -TM) (3 positions minimum) (Not available with -A) (Manual placement required)
- K**
= (6.50 mm) .256" DIA Polyimide Film Pick & Place Pad
(-SH: 4 positions minimum without -TR; 2 & 3 positions available with -TR) (-DH: 4 positions minimum without -TR)
- P**
= Plastic Pick & Place Pad
(-DV: 4 positions minimum without -TR; 2 & 3 positions available with -TR) (-SH: 4 positions minimum without -TR; 2 & 3 positions available with -TR) (-DH: 5 positions minimum without -TR) (-SV: 4 positions minimum without -TR; 2 & 3 positions available with -TR)
- TR**
= Tape & Reel
-SV: 02-22 positions, -DV: 02-28 positions, -SH: 02-30 positions, -DH: 02-29 positions (Not available with -MT or -TM)
- FR**
= Full Reel Tape & Reel
(must order maximum quantity per reel; contact Samtec for quantity breaks)
-SV: 02-22 positions, -DV: 02-28 positions, -SH: 02-30 positions, -DH: 02-29 positions (Not available with -MT or -TM)

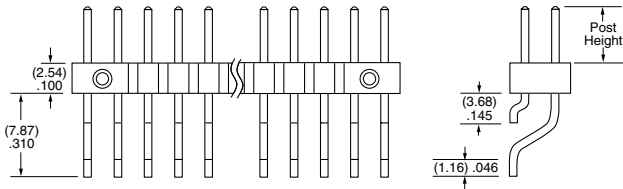
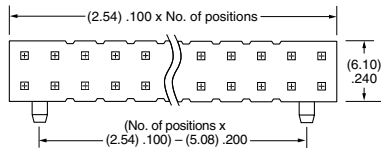

-DH Row Option

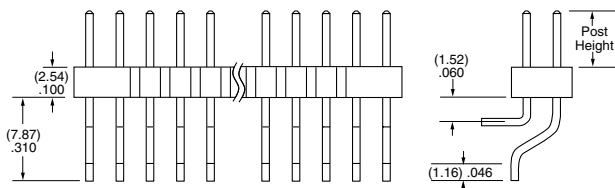
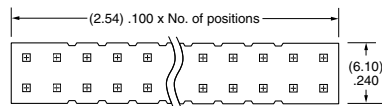

-MT Row Option

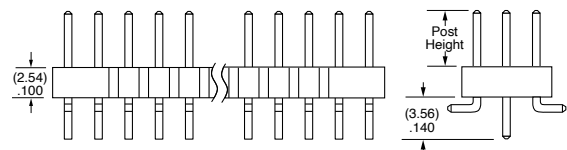
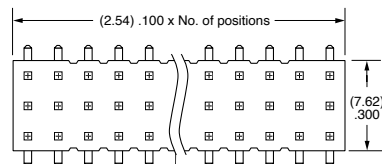

-TM Row Option

MODIFIED .025" SQ POST HEADERS

(2.54 mm) .100" PITCH • MTSW/HMTSW SERIES

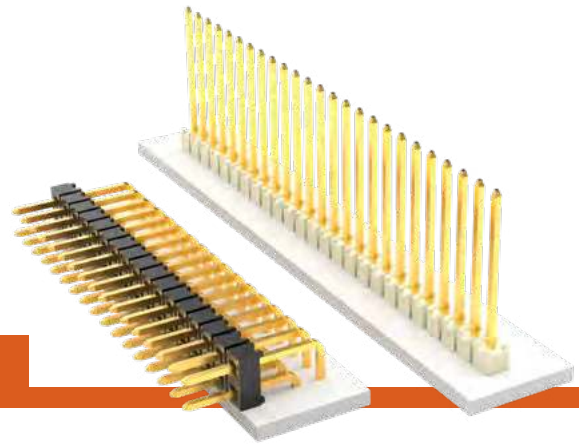

MTSW/HMTSW

Board Mates:

SSW, SSQ, ESW,
ESQ, BCS, BSW
CES, SLW, HLE, SSM

Cable Mates:

IDSD, IDSS

SPECIFICATIONS

Insulator Material:

MTSW: Black Glass
Filled Polyester
HMTSW: Natural Liquid
Crystal Polymer

Terminal Material:

Phosphor Bronze

Plating:

Au or Sn over
50 μm (1.27 μm) Ni

Operating Temp Range:

-55 °C to +125 °C with Gold
-55 °C to +105 °C with Tin

PROCESSING

Lead-Free Solderable:

MTSW: No, Lead Wave Only
HMTSW: Yes

SERIES	PIN CENTERS	NO. PINS PER ROW	LEAD STYLE
MTSW = Modified Strip	-1 = (2.54 mm) .100" Pitch (All positions filled)	01 thru 50 = .100" (2.54 mm) Center Version	Specify LEAD STYLE from chart
HMTSW = Hi-Temp Modified Strip	-2 = (5.08 mm) .200" Pitch (Every other position filled)	02 thru 25 = .200" (5.08 mm) Center Version	

LEAD STYLE	OAL
-06	(7.62) .300
-07	(10.92) .430
-08	(13.46) .530
-09	(18.54) .730
-10	(21.08) .830
-11	(23.62) .930
-12	(26.16) 1.030
-13	(31.24) 1.230
-21	(36.32) 1.430
-22	(16.00) .630
-23	(11.30) .445
-24	(12.19) .480
-27	(33.78) 1.330
-28	(28.70) 1.130

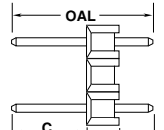
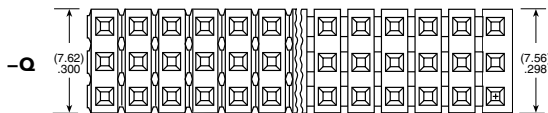
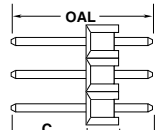
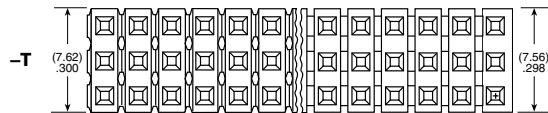
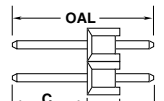
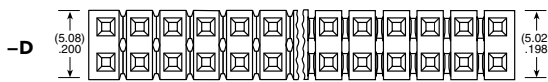
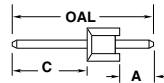
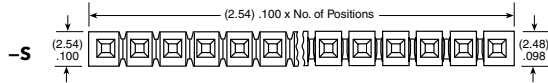
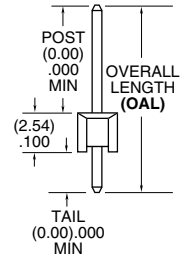

MTSW

HMTSW

Straight Pin Versions: A=OAL-C- (2.54) .100"

FOR "A" = (2.29) .090		
LEAD STYLE	OAL	C MAXIMUM STRAIGHT
-06	(7.62) .300	(2.79) .110
-07	(10.92) .430	(6.10) .240
-08	(13.46) .530	(8.64) .340
-09	(18.54) .730	(13.72) .540
-10	(21.08) .830	(16.26) .640
-11	(23.62) .930	(18.80) .740
-12	(26.16) 1.030	(21.34) .840
-13	(31.24) 1.230	(26.42) 1.040
-21	(36.32) 1.430	(31.50) 1.240
-22	(16.00) .630	(11.18) .440
-23	(11.30) .445	(6.48) .255
-24	(12.19) .480	(7.37) .290
-27	(23.78) 1.330	(28.96) 1.140
-28	(28.70) 1.130	(23.88) .940

Note:

These Series are
non-standard, non-returnable.

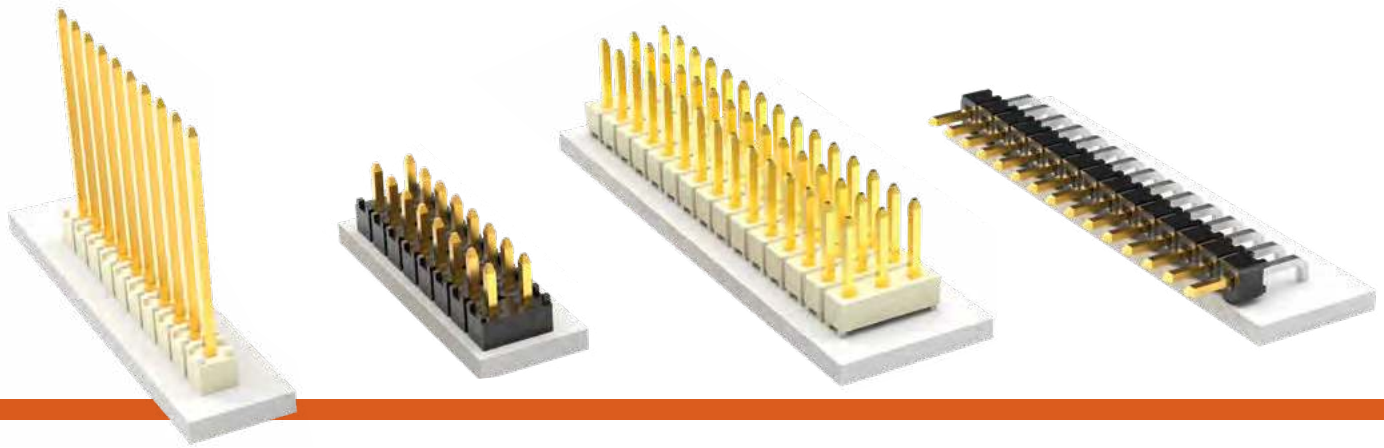

PLATING OPTION

- F**
= Gold flash on post,
Matte Tin on tail
- L**
= 10 μ" (0.25 μm)
Gold on post,
Matte Tin on tail
- G**
= 10 μ" (0.25 μm)
Gold on post,
Gold flash on balance
- T**
= Matte Tin

ROW OPTION

- S**
= Single Row
- D**
= Double Row
- T**
= Triple Row
- Q**
= Double Row
.200" (5.08 mm)
row space

POST HEIGHT

"XXXX"
= "C" Dimension
(Specify post height in
INCHES
.005" (0.13 mm) increments)

OTHER OPTION

- RA or -RE**
= Right-angle
(HMTSW -S & -D =
36 positions maximum)
- LL**
= Locking Lead
(not available with -RE, not available
in single row 1 or 2 positions)
(Available on tails from (2.29 mm) .090"
to (10.16 mm) .400" only)
- LA**
= -RA option with -LL Option
(Maximum "C" = (13.46 mm) .530")

POLARIZED OPTION

"XXX"
= Polarized
(Specify 'XXX' as position number)

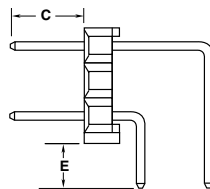
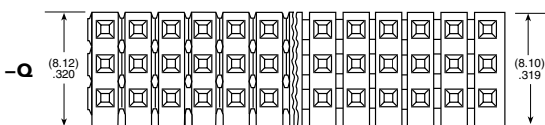
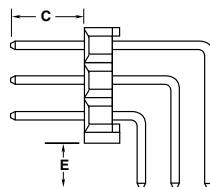
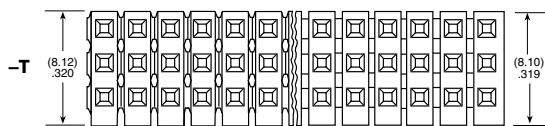
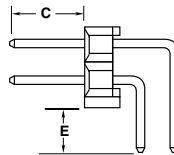
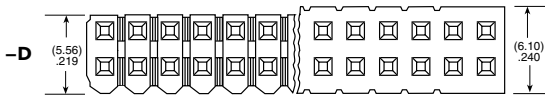
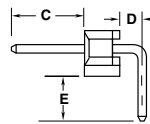
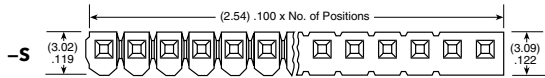

MTSW

HMTSW

-RX OPTION	D
-RA	(1.52) .060
-RE	(4.06) .160

FOR "E" = (2.29) .090 MIN FOR -RA & -RE			
LEAD STYLE	OAL	C MAXIMUM with/-RA	C MAXIMUM with/-RE
-06	(7.62) .300	Not Available	Not Available
-07	(10.92) .430	(3.30) .130	Not Available
-08	(13.46) .530	(5.84) .230	(3.30) .130
-09	(18.54) .730	(10.92) .430	(8.38) .330
-10	(21.08) .830	(13.46) .530	(10.92) .430
-11	(23.62) .930	(16.00) .630	(13.46) .530
-12	(26.16) 1.030	(18.54) .730	(16.00) .630
*-13	(31.24) 1.230	(23.62) .930	(21.08) .830
*-21	(36.32) 1.430	(28.70) 1.130	(26.16) 1.030
-22	(16.00) .630	(8.38) .330	(5.84) .230
*-23	(11.30) .445	(3.68) .145	Not Available
*-24	(12.19) .480	(4.57) .180	
*-27	(23.78) 1.330	(26.16) 1.030	(23.62) .930
*-28	(28.70) 1.130	(21.08) .830	(18.54) .730

* Styles -21, -23, -24, -27 not available with -D Right-angle
Styles -13, -21, -23, -24, -27, -28 not available with -T or -Q Right-angle

Right-Angle Versions (- RA Options): E=OAL-C- (5.33) .210"

Right-Angle Versions (-RE Options) Single Row Only: E=OAL-C- (7.87) .310"

LOW PROFILE .025" SQ POST HEADERS

(2.54 mm) .100" PITCH • TLW/MTLW SERIES

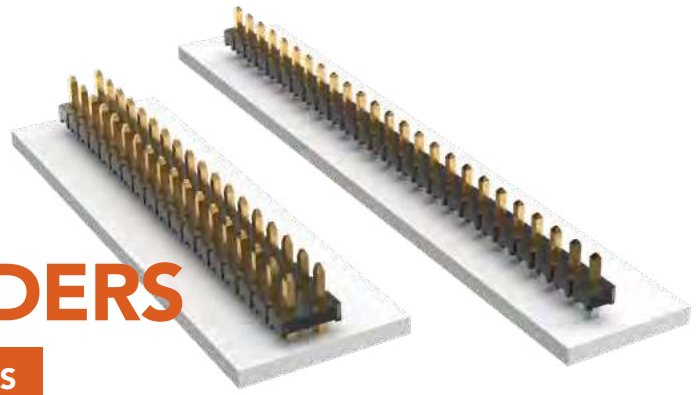

TLW/MTLW

Board Mates:
BSW, CES, SLW, HLE

FEATURES

These headers provide the ultimate low profile (0.64 mm) .025" square post board stacking system. The high quality Phosphor Bronze terminals are available with a standard short post height (TLW Series) for mating with low profile sockets, or the post height can be Modified (MTLW Series) to accommodate IDC assemblies and other applications.

SPECIFICATIONS

Insulator Material:
Black Liquid Crystal Polymer
Terminal Material:
Phosphor Bronze
Plating:

Au or Sn over
50 μ" (1.27 μm) Ni
Current Rating (TLW/SLW):
5.2 A per pin
(2 pins powered)
Operating Temp Range:
-55 °C to +105 °C with Tin
-55 °C to +125 °C with Gold

PROCESSING

Lead-Free Solderable:
Yes

ALSO AVAILABLE

MOQ Required

Other platings
Notch option

Note:
Some lengths, styles and options are non-standard, non-returnable. MTLW Series is non-standard, non-returnable.

TLW	1	NO. PINS PER ROW	LEAD STYLE	PLATING OPTION	ROW OPTION	OTHER OPTION
-----	---	------------------	------------	----------------	------------	--------------

01 thru 40
= Single Row
01 thru 36
= Double Row

Specify
LEAD STYLE
from chart

-F
= Gold flash on post, Matte Tin on tail
-G
= 10 μ" (0.25 μm) Gold on post, Gold flash on tail
-T
= Matte Tin

-S
= Single Row
-D
= Double Row

-RA
= Right-angle (-01 Lead Style only)
-"XX"
= Polarized Position Specify position for omitted pin.

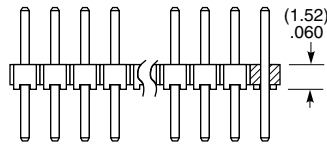
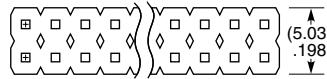
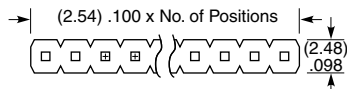

-05 & -06

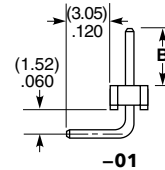

LEAD STYLE	A	B
-01	N/A	(5.84) .230
-05	(4.32) .170	(2.67) .105
-06	(3.43) .135	

MTLW	1	NO. PINS PER ROW	LEAD STYLE	PLATING OPTION	ROW OPTION	POST HEIGHT
------	---	------------------	------------	----------------	------------	-------------

01 thru 40
= Single Row
01 thru 36
= Double Row

Specify
LEAD STYLE
from chart

-F
= Gold flash on post, Matte Tin on tail
-L
= 10 μ" (0.25 μm) Gold on post, Matte Tin on tail
-G
= 10 μ" (0.25 μm) Gold on post, Gold flash on tail
-T
= Matte Tin

-S
= Single Row
-D
= Double Row

-"XXX"
= Post Height Dimension (In inches)

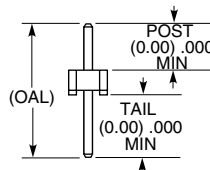
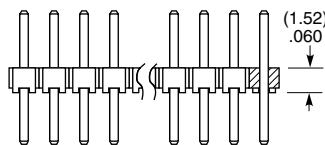
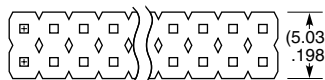
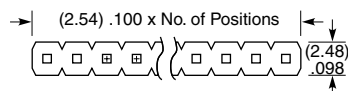

LEAD STYLE	OAL
-05	(8.51) .335
-06	(7.62) .300
-07	(10.92) .430
-08	(13.46) .530
-09	(18.54) .730
-10	(21.08) .830
-22	(16.00) .630
-23	(11.30) .445
-24	(12.19) .480

FLEX STACK

FLEXIBLE .025" SQ BOARD STACKERS

(2.54 mm) .100" PITCH • HW SERIES

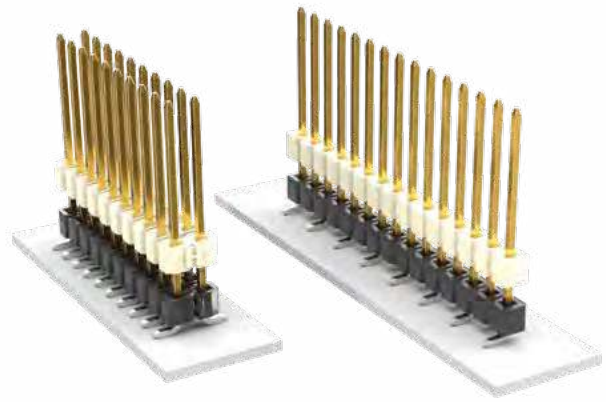

HW

Board Mates:

SSW, SSQ, ESW, ESQ, CES, SLW, BSW, BCS, SSM, HLE, PHF

Cable Mates:

IDSS, IDSD

SPECIFICATIONS

Insulator Material:

HW-SM Top = Natural LCP
HW-SM Bottom = Black LCP
HW-TH = Natural LCP

Terminal Material:

Phosphor Bronze

Plating:

Au or Sn over

50 μ" (1.27 μm) Ni

Operating Temp Range:

-55 °C to +125 °C with Gold

-55 °C to +105 °C with Tin

PROCESSING

Lead-Free Solderable:

Yes

SMT Lead Coplanarity:

(0.15 mm) .006" max*
*(.004" stencil solution may be available; contact ipg@samtec.com)

ALSO AVAILABLE MOQ Required

Other platings

Locking Clip available with double row HW-SM
(Manual placement required)

Notes:

For added mechanical stability, Samtec recommends mechanical board spacers be used in applications with gold or selective gold plated connectors. Contact ipg@samtec.com for more information.

This Series is non-standard, non-returnable.

HW	NO. PINS PER ROW	LEAD STYLE	PLATING OPTION	ROW OPTION	STACKER HEIGHT	SM	OTHER OPTION
----	------------------	------------	----------------	------------	----------------	----	--------------

01 thru 50
(Through-hole)

02 thru 36
(Surface mount)

Specify LEAD STYLE from chart

-F
= Gold flash on contact, Matte Tin on tail

-L
= 10 μ" (0.25 μm) Gold on contact area of longer tail, Matte Tin on tail

-G
= 10 μ" (0.25 μm) Gold on contact area of longer tail, Gold flash on balance

-T
= Matte Tin

-S
= Single Row

-D
= Double Row

-T
= Triple Row (Through-hole only)

-Q
= Double Row .200" (5.08 mm) row space (Through-hole only)

-"XXX"
= Stacker Height (in inches)

Through-hole = (5.08 mm) .200" Min.

Surface mount = (6.35 mm) .250" Min.

Leave blank for Through-hole

-"XXX"

= HW-TH Tail Length (in inches) (1.40 mm) .055" min. Example: -250 = (6.35 mm) .250"

-LL
= Locking Lead (Through-hole only) (Shortest dimension between the tail and the post is the end that will be crimped. Available on tails from (2.29 mm) .090" to (7.87 mm) .310" only.) Single row, 01 & 02 positions & -Q row not available

-"XXX"
= Polarized (Specify omitted pin position)

-A
= Alignment Pin (Metal or plastic at Samtec discretion) (Surface mount only)

-TR
= Tape & Reel (4-27 pins per row only) (Not Available on Lead Styles 10, 11, 12 & 20) (Surface mount only)

-FR
= Full Reel Tape & Reel (must order max. quantity per reel; contact Samtec for quantity breaks) (4-27 pins per row only) (Not Available on Lead Styles 10, 11, 12 & 20) (Surface mount only)

LEAD STYLE	OAL (TH)
-07	(10.92) .430
-08	(13.46) .530
-09	(18.54) .730
-10	(21.08) .830
-11	(23.62) .930
-12	(26.16) 1.030
-13	(31.24) 1.230
-14	(36.32) 1.430
-15	(16.00) .630
-16	(11.30) .445
-17	(12.19) .480
-19	(33.78) 1.330
-20	(28.70) 1.130

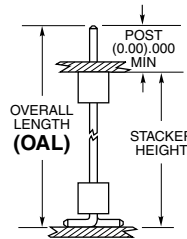

LEAD STYLE	OAL (SMT)
-08	(11.81) .465
-09	(16.89) .665
-10	(19.43) .765
-11	(21.97) .865
-12	(24.51) .965
-15	(14.35) .565
-16	(9.65) .380
-17	(10.54) .415
-20	(27.05) 1.065

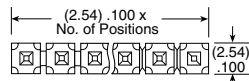

-S

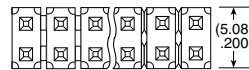

-D

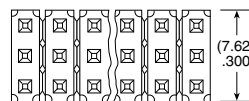

-T or -Q*

-Q* same as -T except middle row pins are removed

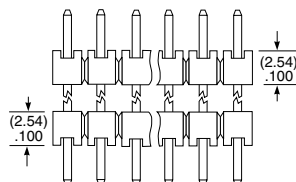

HW-TH

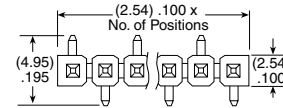

-S

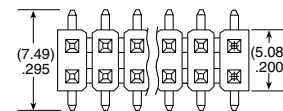

-D

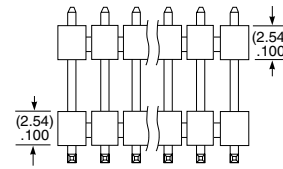

HW-SM

FLEXIBLE .025" SQ BOARD STACKERS

(2.54 mm) .100" PITCH • DW/EW/ZW SERIES



DW/EW/ZW

Board Mates:

SSW, SSQ, ESW, ESQ, CES, SLW, BSW, BCS, SSM, HLE, PHF

Cable Mates:

IDSS, IDSD

SPECIFICATIONS

Insulator Material:

Black Glass Filled Polyester

Terminal Material:

Phosphor Bronze

Plating:

Au or Sn over
50 μ" (1.27 μm) Ni

Operating Temp Range:

-55 °C to +125 °C with Gold
-55 °C to +105 °C with Tin

PROCESSING

Lead-Free Solderable:

No, Lead Wave Only

SERIES	NO. PINS PER ROW	LEAD STYLE	PLATING OPTION	ROW OPTION	STACKER HEIGHT	OTHER OPTION
DW = (2.79 mm) .110" Tail	01 thru 50	Specify LEAD STYLE from chart	-F = Gold flash on contact, Matte Tin on tail	-S = Single Row	-"XXX" = Stacker Height (in inches) (5.08 mm) .200" minimum	-"XXX" = ZW Tail Length (in inches) (1.40 mm) .055" minimum
EW = (8.38 mm) .330" Tail			-L = 10 μ" (0.25 μm) Gold on contact area of longer tail, Matte Tin on tail	-D = Double Row	Example: -250 = (6.35 mm) .250"	Example: -250 = (6.35 mm) .250"
ZW = Custom Tail			-G = 10 μ" (0.25 μm) Gold on contact area of longer tail, Gold flash on balance	-T = Triple Row		-LL = Locking Lead (Shortest dimension between the tail and the post is the end that will be crimped. Available on tails from (2.29 mm) .090" to (7.87 mm) .310" only.) Single row, 01 & 02 positions & -Q row not available
			-T = Matte Tin	-Q = Double Row .200" (5.08 mm) row space		-"XXX" = Polarized (Specify omitted pin position)

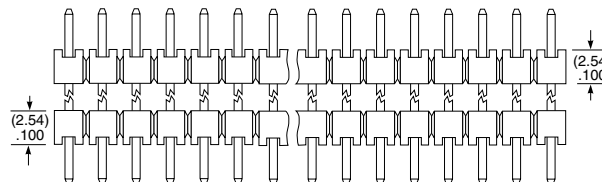
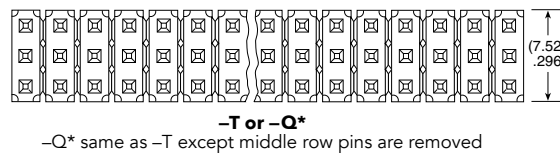
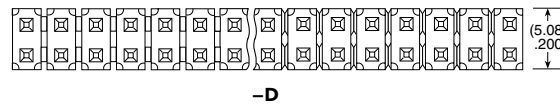
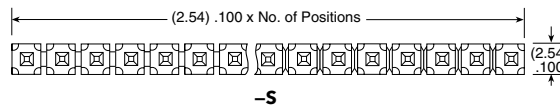

LEAD STYLE	OAL
-07	(10.92) .430
-08	(13.46) .530
-09	(18.54) .730
-10	(21.08) .830
-11	(23.62) .930
-12	(26.16) 1.030
-13	(31.24) 1.230
-14	(36.32) 1.430
-15	(16.00) .630
-16	(11.30) .445
-17	(12.19) .480
-19	(33.78) 1.330
-20	(28.70) 1.130

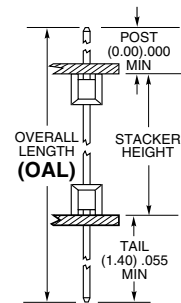

Notes:

For added mechanical stability, Samtec recommends mechanical board spacers be used in applications with gold or selective gold plated connectors. Contact jpg@samtec.com for more information.

This Series is non-standard, non-returnable.

SHROUDED .025" SQ POST HEADERS

(2.54 mm) .100" PITCH • TSS/HTSS/ZSS SERIES

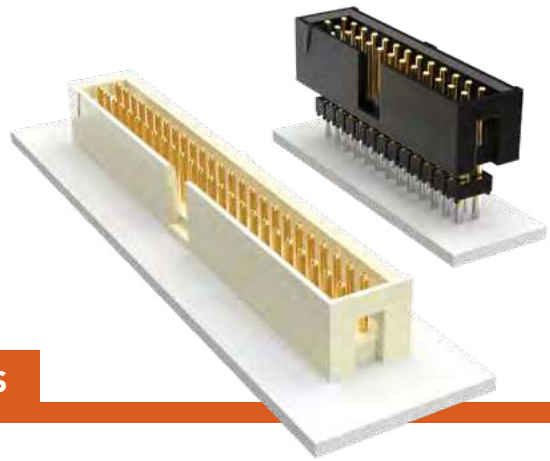

TSS/HTSS/ZSS

Mates:
SSW, SSQ, ESW, ESQ,
SSM, BCS

SPECIFICATIONS

Insulator Material:
TSS, ZSS=Black Glass Filled Polyester
HTSS=Natural PCT
Insulation Resistance:
5000 MΩ min
Terminal Material:
Phosphor Bronze
Plating: Au or Sn over 50 μ" (1.27 μm) Ni
Operating Temp Range:
-55 °C to +125 °C with Gold
-55 °C to +105 °C with Tin
Withstanding Voltage:
1000 VRMS

PROCESSING

Lead-Free Solderable:
HTSS=Yes
TSS, ZSS=No, Lead Wave only
SMT Lead Coplanarity:
(0.15 mm) .006" max*
*(.004" stencil solution may be available; contact ipg@samtec.com)

SERIES	1	NO. PINS PER ROW	LEAD STYLE	PLATING OPTION	ROW OPTION
--------	---	------------------	------------	----------------	------------

TSS
= Connector Strip
HTSS
= High Temp Connector Strip

03
(TSS only)
05, 07, 08, 10, 12, 13, 15, 17, 20, 25, 32, 36
(Standard sizes)

Specify LEAD STYLE from chart

-F
= Gold flash on post, Matte Tin on tail
(Not available on -DV)

-L
= 10 μ" (0.25 μm) Gold on post, Matte Tin on tail

-T
= Matte Tin

-D
= Double Row Through-hole (lead style -01, -02 & -03 only)

-DV
= Double Row Surface Mount (lead style -01 only) (HTSS only)

-D-RA
= Double Row Right-angle (lead style -04 & -05 only)

LEAD STYLE	T/H (A)
-01	(2.92) .115
-02	(4.19) .165
-03	(14.35) .565

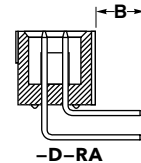
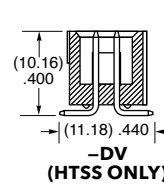
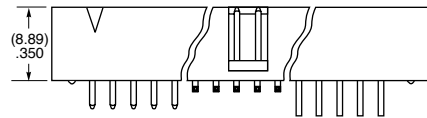
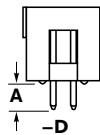
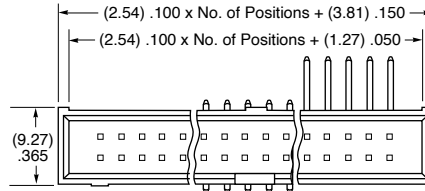

ZSS	1	NO. PINS PER ROW	LEAD STYLE	PLATING OPTION	D	BODY HEIGHT
-----	---	------------------	------------	----------------	---	-------------

03, 05, 07, 08, 10, 12, 13, 15, 17, 20, 25, 32, 36
(Standard sizes)

Specify LEAD STYLE from chart

-F
= Gold flash on post, Matte Tin on tail

-L
= 10 μ" (0.25 μm) Gold on post, Matte Tin on tail

-T
= Matte Tin

"-XXXX"
= Body Height

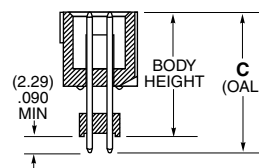
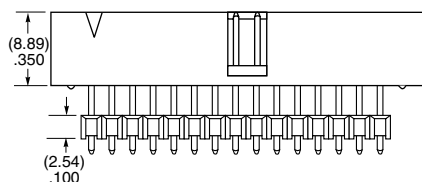
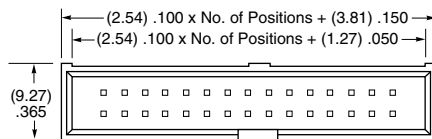

LEAD STYLE	C (OAL)	MAX BODY HEIGHT
-01	(16.00) .630	(13.72) .540
-02	(18.54) .730	(16.26) .640
-03	(21.08) .830	(18.80) .740
-04	(23.62) .930	(21.34) .840
-05	(26.16) 1.030	(23.88) .940
-06	(28.70) 1.130	(26.42) 1.040
-07	(31.24) 1.230	(28.96) 1.140
-08	(33.78) 1.330	(31.50) 1.240
-09	(36.32) 1.430	(34.04) 1.340

Note:
Some lengths, styles and options are non-standard, non-returnable. ZSS is non-standard, non-returnable.

Note:
For added mechanical stability, Samtec recommends mechanical board spacers be used in applications with gold or selective gold plated connectors. Contact ipg@samtec.com for more information.

THROUGH-HOLE .025" SQ POST SOCKET

(2.54 mm) .100" PITCH • SSW/SSQ SERIES

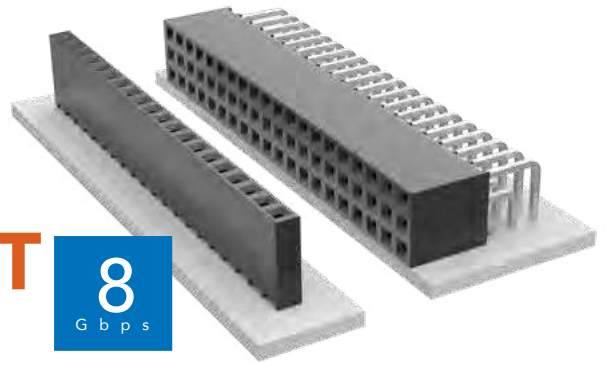

SSW/SSQ

Mates:

TSW, MTSW, MTLW,
DW, EW, ZW, TSS, ZSS,
TSM, TSSH, HTSS

SPECIFICATIONS

Insulator Material:

Black Liquid Crystal Polymer (-S & -D) or
Black High Temperature Thermoplastic (-T)

Contact Material:

Phosphor Bronze

Plating:

Au or Sn over
50 μ" (1.27 μm) Ni

Current Rating (SSW/TSM):

4.7 A per pin
(2 pins powered)

Current Rating (SSQ/TSW):

6.3 A per pin
(2 pins powered)

Operating Temp Range:

-55 °C to +125 °C with Gold
-55 °C to +105 °C with Tin

Insertion Depth:

(3.68 mm) .145" to
(6.35 mm) .250"

Max Cycles:

100 with 10 μ" (0.25 μm) Au

Voltage Rating:

465 VAC / 655 VDC

PROCESSING

Lead-Free Solderable:

Yes:
-S and -D row option
No, Lead Wave only:
-P, -T and -Q row option

SERIES	1	NO. PINS PER ROW	LEAD STYLE	PLATING OPTION	ROW OPTION	TAIL OPTION	OTHER OPTION
--------	---	------------------	------------	----------------	------------	-------------	--------------

SSW
= Solder Tail

01 thru 50

Specify
LEAD STYLE
from chart

-F
= Gold flash on contact,
Matte Tin on tail

-S
= Single Row

Leave blank for straight pin version)

-LL
= Locking Lead

SSQ
= Square Tail

-L
= 10 μ" (0.25 μm)
Gold on contact,
Matte Tin on tail

-P
= Single Row
(36 pins max)

-RA
= Right-angle

Available on tails from
(2.29 mm) .090" to
(7.87 mm) .310" only.
Not Available with single row 1 or 2 positions)

-G
= 20 μ" (0.51 μm)
Gold on contact,
Gold flash on tail

-D
= Double Row

-T
= Triple Row

-Q
= Double Row
.200" (5.08 mm)
row space (outer rows filled only)

"XXX"
= Polarized
(Specify "XXX" as position number)

-T
= Matte Tin
(-T N/A on LIF contacts)

THROUGH-HOLE		
LEAD STYLE		SINGLE DOUBLE OR TRIPLE A
Standard Insertion Force	Low Insertion Force*	
-01	-21	(2.64) .104
-02	-22	(4.93) .194
-03	-23	(10.00) .394
-04	-24	(14.83) .584
-06**	N/A	(3.15) .124

* LIF not available with Tin Plating
**Style -06 Not available with SSQ

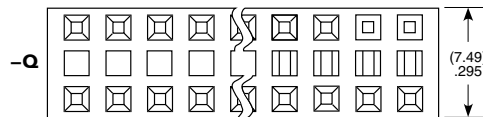
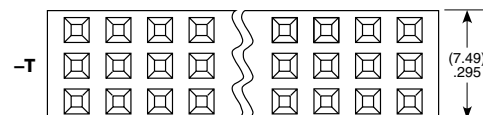
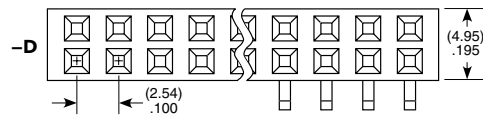
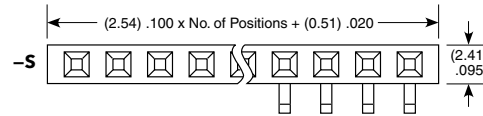

Through-hole

Right-angle

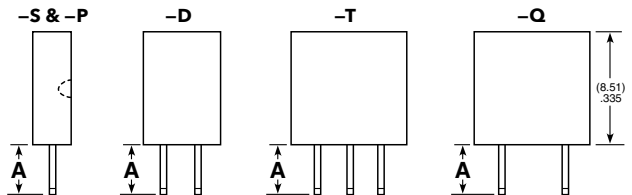

Straight Pin Versions

RIGHT-ANGLE				
LEAD STYLE		SINGLE	DOUBLE	TRIPLE
Standard Insertion Force	Low Insertion Force*	(-S) B	(-D) B	(-T & -Q) B
-02	-22	(2.54) .100	(2.54) .100	(2.54) .100
-03	-23	(7.62) .300	(7.62) .300	N/A
-04	-24	(12.45) .490	N/A	N/A

*LIF not available with Tin Plating

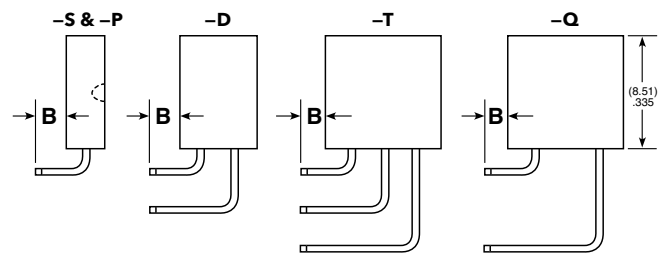

Right-angle Versions

Note:

Some lengths, styles and options are non-standard, non-returnable.

SURFACE MOUNT .025" SQ POST SOCKET

(2.54 mm) .100" PITCH • SSW SERIES

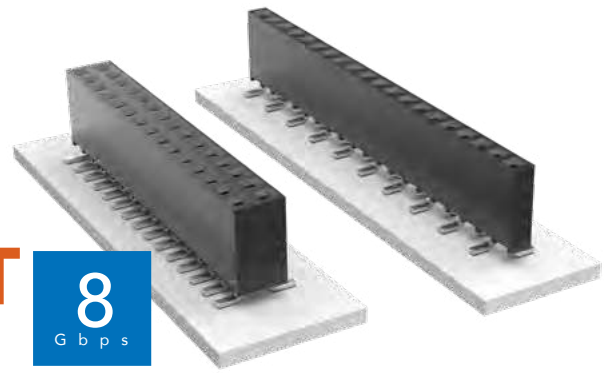

SSW

Mates:

TSW, MTSW, HTSW,
HMTSW, MTLW, EW, ZW,
TSS, HTSS, ZSS, TSM,
TSSH, DW, HW

SPECIFICATIONS

Insulator Material:

Black LCP

Contact Material:

Phosphor Bronze

Plating:

Au or Sn over

50 μ" (1.27 μm) Ni

Current Rating (SSW/TSM):

4.7 A per pin

(2 pins powered)

Operating Temp Range:

-55 °C to +125 °C with Gold

-55 °C to +105 °C with Tin

Insertion Depth:

(3.68 mm) .145" to

(6.35 mm) .250"

Max Cycles:

100 with 10 μ" (0.25 μm) Au

Voltage Rating:

465 VAC / 655 VDC

PROCESSING

Lead-Free Solderable:

Yes

SMT Lead Coplanarity:

(0.10 mm) .004" max

ALSO AVAILABLE

MOQ Required

Other platings

Notch option

Note:

Some lengths, styles and options are non-standard, non-returnable.

SSW	1	NO. PINS PER ROW	22	PLATING OPTION	ROW OPTION	VS	OTHER OPTION
		02 thru 36		<p>-F = Gold flash on contact, Matte Tin on tail</p> <p>-L = 10 μ" (0.25 μm) Gold on contact, Matte Tin on tail</p> <p>-G = 20 μ" (0.51 μm) Gold on contact, Gold flash on tail</p>	<p>-S = Single Row</p> <p>-D = Double Row</p>		<p>-"XX" = Polarized Position</p> <p>-K = -S: (3.50 mm) .138" DIA, -D: (6.50 mm) .256" DIA Polyimide film Pick & Place Pad (03 positions min.)</p> <p>-P = Pick & Place Pad (05 positions min.)</p> <p>-TR = Tape & Reel (-02 thru -28)</p> <p>-FR = Full Reel Tape & Reel (must order max. quantity per reel; contact Samtec for quantity breaks) (-02 thru -28)</p>

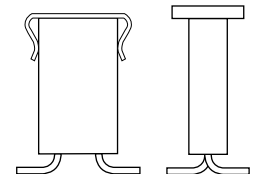
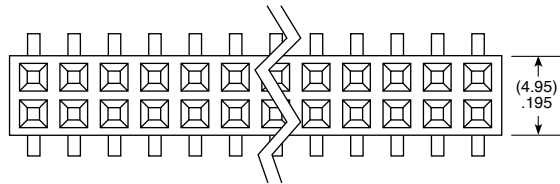
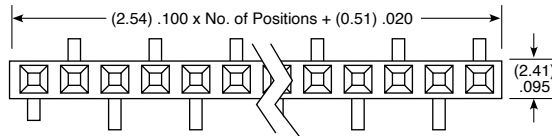

-P OPTION

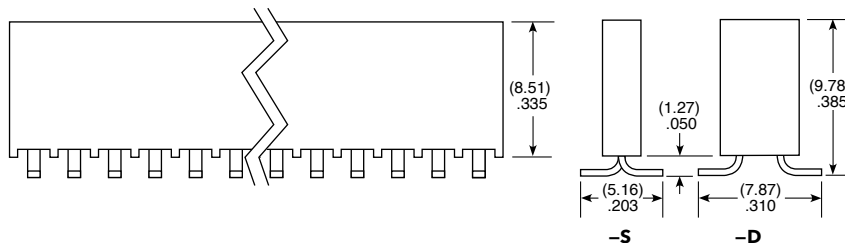

TIGER CLAW™ SURFACE MOUNT SOCKET

(2.54 mm) .100" PITCH • SSM SERIES

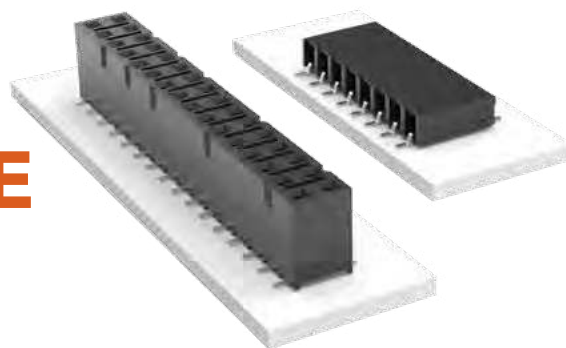

SSM

Mates:

TSW, MTSW,
TST, TSS, ZST, ZSS,
DW, EW, ZW, TSM,
HMTSW, HTSW, TSSH,
BST, HTSS, TLW, MTLW

SPECIFICATIONS

Insulator Material:

Black Liquid Crystal Polymer

Contact Material:

Phosphor Bronze

Plating:

Au or Sn over
50 μ" (1.27 μm) Ni

Current Rating (SSM/TSW):

5.2 A per pin
(2 pins powered)

Voltage Rating:

405 VAC / 572 VDC

Operating Temp Range:

-55 °C to +125 °C with Gold
-55 °C to +105 °C with Tin

Insertion Depth:

SV/DV = (4.34 mm) .171" to
(7.24 mm) .285" or pass-through
from top; (5.56 mm) .219"
plus board thickness minimum
from bottom;
SH/DH = (4.34 mm) .171" to
(6.35 mm) .250"

PROCESSING

Lead-Free Solderable:

Yes

-DH Coplanarity:

Less than 28 positions
(0.15 mm) .006" max*
More than 27 positions
(0.20 mm) .008" max*

-SH, -SV, -DV Coplanarity:

(0.15 mm) .006" max*
*(.004" stencil solution
may be available; contact
ipg@samtec.com)

ALSO AVAILABLE

MOQ Required

Alignment pin



Notes:

Severe Environment
Testing qualified; aligns
with MIL-DTL-55302.
Visit samtec.com/set

Some sizes, styles and
options are non-standard,
non-returnable.

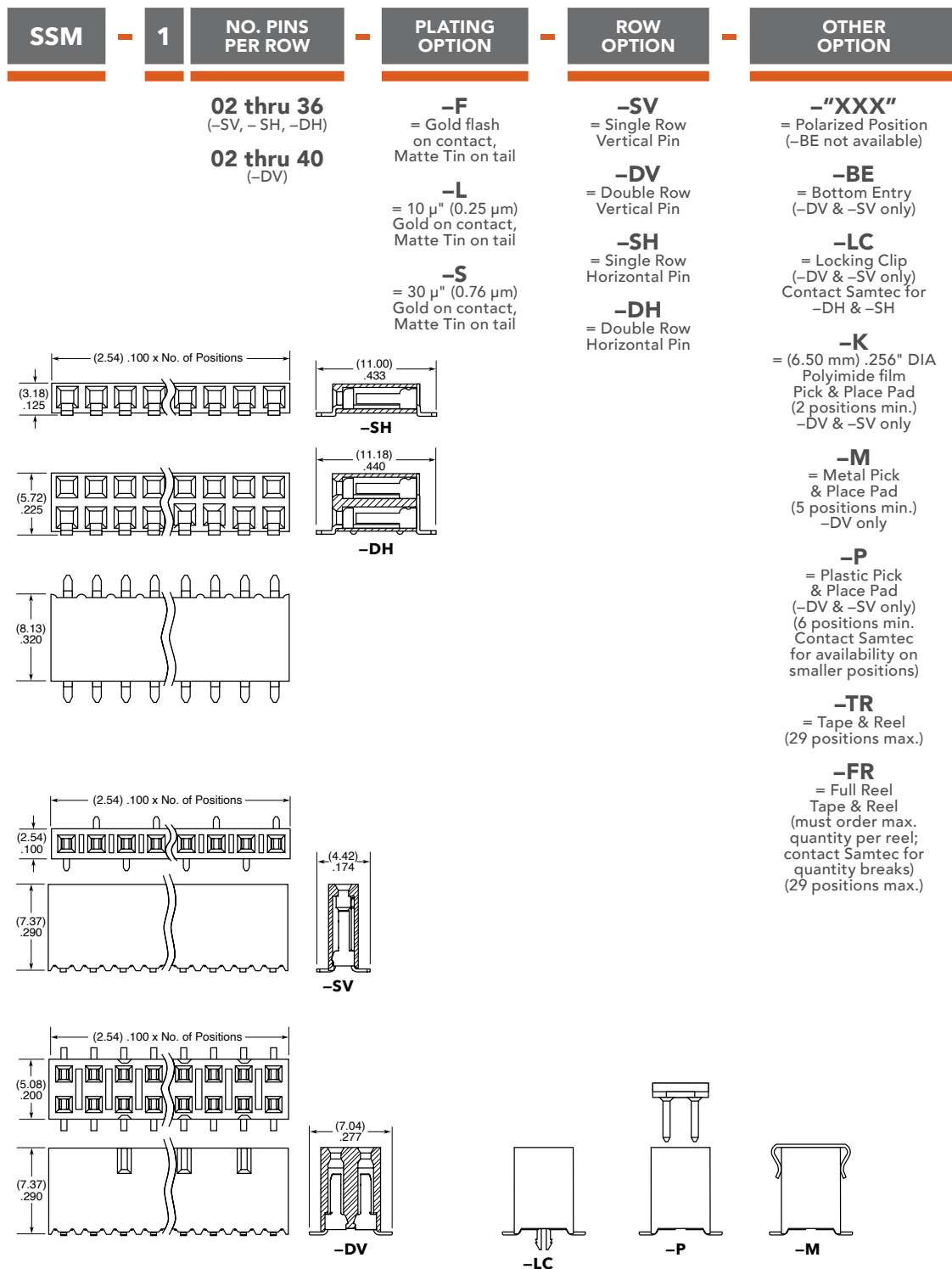

ELEVATED SOCKETS

(2.54 mm) .100" PITCH • ESW/ESQ SERIES

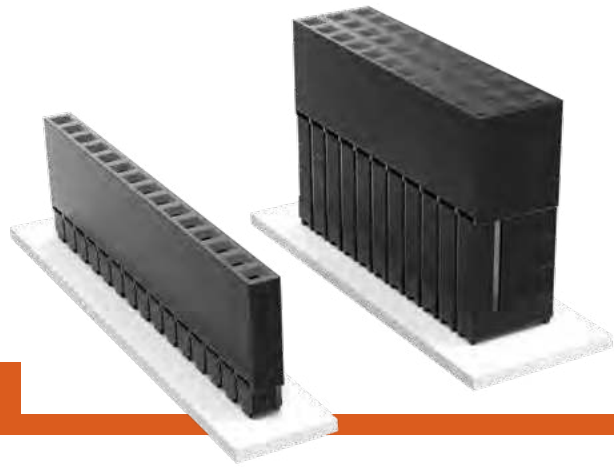

ESW/ESQ

Mates:

TSW, MTSW, EW, MTLW, TSS, ZSS, TSM, DW, ZW, HW, TSSH, HTSS

SPECIFICATIONS

Insulator Material:

Black Glass Filled Polyester

Contact Material:

Phosphor Bronze

Plating:

Au or Sn over 50 μ" (1.27 μm) Ni

Current Rating (ESW/TSW):

5.2 A per pin (2 pins powered)

Current Rating (ESQ/TSW):

5.7 A per pin (2 pins powered)

Voltage Rating:

515 VAC mated with TSW or ESQ

Operating Temp Range:

-55 °C to +125 °C with Gold

-55 °C to +105 °C with Tin

Insertion Depth:

(3.68 mm) .145" to (6.35 mm) .250"

Max Cycles:

100 with 10 μ" (0.25 μm) Au

PROCESSING

Lead-Free Solderable:

No, Lead Wave only

SERIES	1	NO. PINS PER ROW	LEAD STYLE	PLATING OPTION	ROW OPTION	OTHER OPTION
--------	---	------------------	------------	----------------	------------	--------------

ESW
= Solder Tail

ESQ
= Square Tail

01 thru 36

Specify **LEAD STYLE** from chart

-L
= 10 μ" (0.25 μm) Gold contact, Matte Tin on tail

-G
= 20 μ" (0.51 μm) Gold contact, Gold Flash on Balance

-T
= Matte Tin (Not available with LIF contact)

-S
= Single Row

-D
= Double Row

-T
= Triple Row (ESQ only)

-LL
= Locking Lead (Two leads per strip crimped. Not available with single row 1 or 2 positions)

"XXX"
= Polarized

LEAD STYLE			
STANDARD INSERTION FORCE	LOW INSERTION FORCE	A	B
-12	-37	(2.29) .090	(11.05) .435
-13	-38	(7.36) .290	
-23	-48	(4.83) .190	(13.59) .535
-33	-58	(2.29) .090	(16.13) .635
-14	-39	(12.19) .480	(11.05) .435
-24	-49	(9.65) .380	(13.59) .535
-34	-59	(7.11) .280	(16.13) .635
-44	-69	(4.57) .180	(18.67) .735

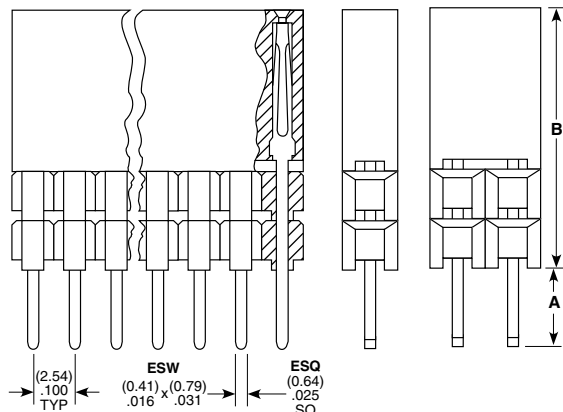
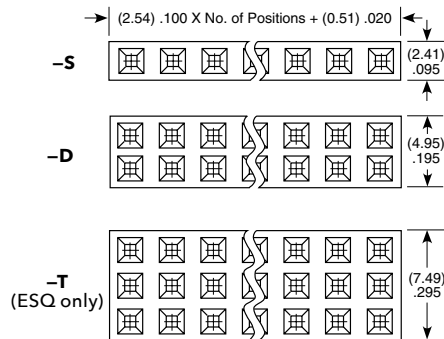

APPLICATIONS

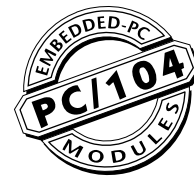

Self Nesting Sockets

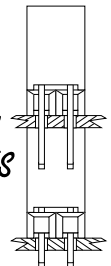

(ESQ SERIES)

ALSO AVAILABLE

MOQ Required

Other Platings

Note: Some lengths, styles and options are non-standard, non-returnable.

PC/104™ J1/P1 "Stackthrough" Connectors	
Standard Insertion Force	ESQ-132-14-G-D
Low Insertion Force	ESQ-132-39-G-D
PC/104™ J1 "Non-Stackthrough" Connectors	
Standard Insertion Force	ESQ-132-12-G-D
Low Insertion Force	ESQ-132-37-G-D
PC/104™ J2/P2 "Stackthrough" Connectors	
Standard Insertion Force	ESQ-120-14-G-D
Low Insertion Force	ESQ-120-39-G-D

PC/104 is a trademark of the PC/104 Consortium.

COST-EFFECTIVE RELIABLE SOCKET

(2.54 mm) .100" PITCH • HLE SERIES

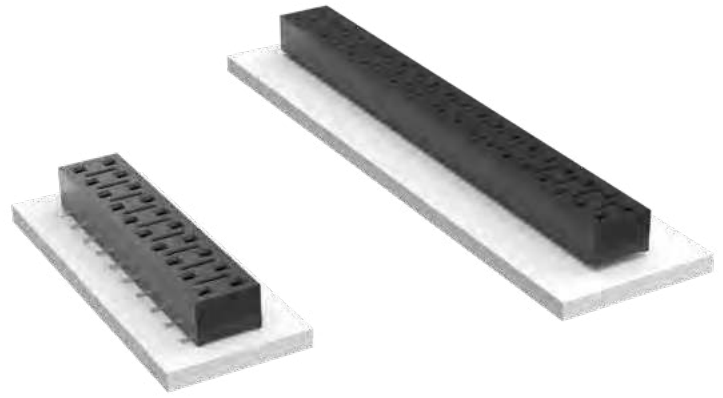

HLE

Board Mates:

TSW, MTSW, DW, EW,
ZW, TLW, TSM, MTLW, HW



02 thru 50

-F
= Gold flash on contact,
Matte Tin on tail

-L
= 10 μ" (0.25 μm)
Gold on contact,
Matte Tin on tail

Leave blank for
Surface Mount
(Requires -BE for
Bottom Entry)

-TE
= Through-hole
Top Entry

-PE
= Through-hole
Pass-through
Entry
(Requires -BE for
Bottom Entry)

-BE
= Bottom Entry
(Not available
with -TE)

-A
= Alignment Pin
(4 positions min.)
Metal or plastic at
Samtec discretion
(Not available with
-TE, -PE & -LC)

-LC
= Locking Clip
(2 positions min.)
(Not available with -A)
(Manual placement
required)

-K
= (6.50 mm)
.256" DIA
Polyimide Film
Pick & Place Pad
(3 positions min.)
Not available
with -TE or
-PE tail option

-P
= Metal Pick
& Place Pad
(3 positions min.)

-TR
= Tape & Reel
(29 positions max.)

-FR
= Full Reel
Tape & Reel
(must order max.
quantity per reel;
contact Samtec for
quantity breaks)

SPECIFICATIONS

Insulator Material:

Black Liquid Crystal Polymer

Contact Material:

BeCu

Plating:

Au or Sn over
50 μ" (1.27 μm) Ni

Current Rating (HLE/TSM):

4.1 A per pin
(2 pins powered)

Voltage Rating:

400 VAC

Operating Temp Range:

-55 °C to +125 °C

Insertion Depth:

(1.78 mm) .070" to
(3.43 mm) .135" pass-through,
or (2.59 mm) .102" min
plus board thickness for
bottom entry

PROCESSING

Lead-Free Solderable:

Yes

SMT Lead Coplanarity:

(0.10 mm) .004" max (02-20)
(0.15 mm) .006" max (21-50)*

*(.004" stencil solution
may be available; contact
ipg@samtec.com)

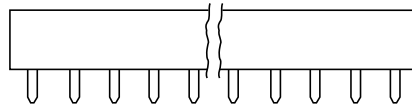
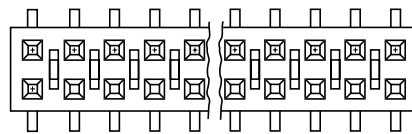
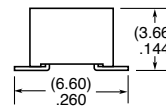
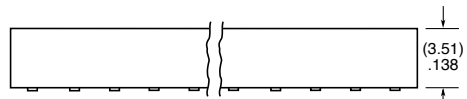
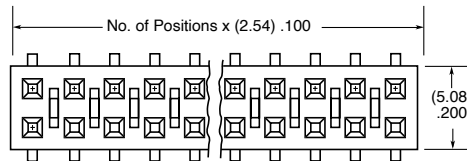

-PE

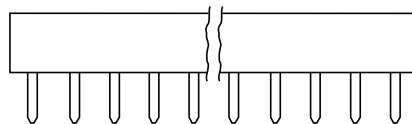
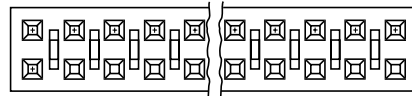
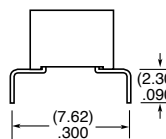

-TE

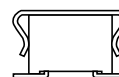
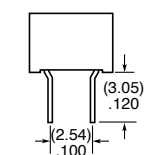

-P



-LC

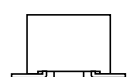

-A

ALSO AVAILABLE

MOQ Required

Other Platings

Note:

Some lengths, styles and
options are non-standard,
non-returnable.

TIGER CLAW™ PASS-THROUGH SOCKET

(2.54 mm) .100" PITCH • BCS SERIES

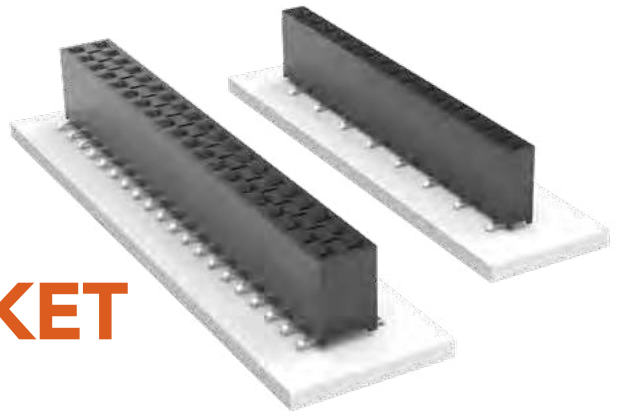

BCS

Mates:

TSW, MTSW, HTSW,
HMTSW, TSS, ZSS, DW, EW,
ZW, HW, TSM, MTLW, PHT

SPECIFICATIONS

Insulator Material:

Black Liquid Crystal Polymer

Contact Material:

Phosphor Bronze

Plating:

Au or Sn over
50 μ" (1.27 μm) Ni

Voltage Rating:

495 VAC
(-TE/-DE/-PE mated with TSM)
450 VAC
(-HE mated with TSW)

Operating Temp Range:

-55 °C to +125 °C

Insertion Depth:

(4.34 mm) .171" to
(7.24 mm) .285" from top,
(5.64 mm) .222" plus board
thickness minimum from bottom.
-HE is (4.34 mm) .171"
to (6.35 mm) .250"

PROCESSING

Lead-Free Solderable:

Yes

MATES	CURRENT RATING (PER PIN)
BCS/TSW	4.6 A
BCS/TSM	5.0 A

2 POSITIONS POWERED

ALSO AVAILABLE
MOQ Required

Other Platings

BCS	1	NO. PINS PER ROW	PLATING OPTION	ROW OPTION	ENTRY OPTION	OTHER OPTION
-----	---	------------------	----------------	------------	--------------	--------------

01 thru 50

-F
= Gold flash on contact,
Matte Tin on tail

-L
= 10 μ" (0.25 μm)
Gold on contact,
Matte Tin on tail

-S
= Single

-D
= Double

-TE
= Top Entry

-DE
= Top Entry
(For Bottom Entry
specify -DE-BE)
Cannot be used with
plated through-holes

-PE
= Pass-through Entry
(For Bottom Entry
specify -PE-BE)

-HE
= Horizontal Entry

-"XXX"
= Polarized Position
(-BE not available)

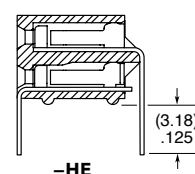
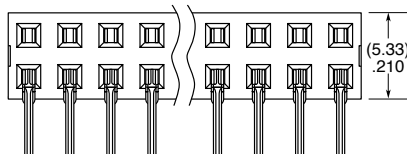
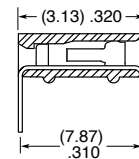
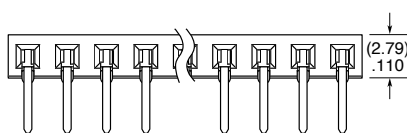
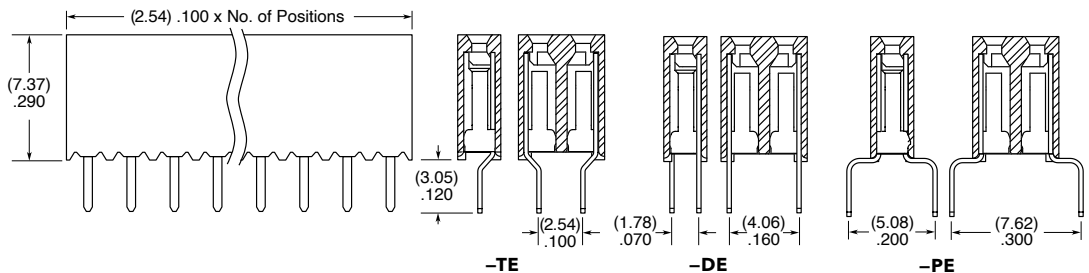
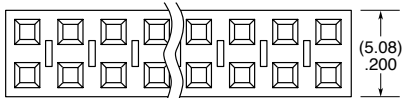
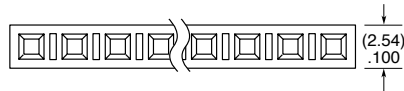

Note:

Some lengths, styles and
options are non-standard,
non-returnable.

BOTTOM MOUNT SOCKET STRIPS

(2.54 mm) .100" PITCH • BSW SERIES

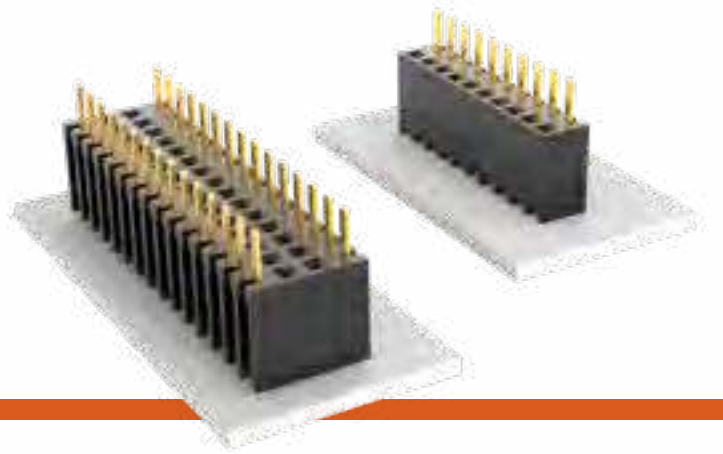

BSW

Mates:

TSW, MTSW, HTSW,
MTLW, TSM, EW, ZW,
HW, DW, PHT

FEATURES

- Bottom mount socket strips accept .025" SQ terminals.
- Ideal for soldering and plugging from the same side of the board.
- For low profile connections and high temperature soldering.

SPECIFICATIONS

Insulator Material:

Black Thermoplastic

Insulation Resistance:

5000 MΩ min

Contact Material:

Phosphor Bronze

Plating:

Au or Sn over

50 μ" (1.27 μm) Ni

Operating Temp Range:

-55 °C to +125 °C with Gold

-55 °C to +105 °C with Tin

Withstanding Voltage:

1000 VRMS @ 60 Hz

Insertion Depth:

(3.68 mm) .145" to

(6.35 mm) .250"

PROCESSING

Lead-Free Solderable:

Wave only

ALSO AVAILABLE

MOQ Required

Other Platings

BSW	- 1	NO. PINS PER ROW	LEAD STYLE	PLATING OPTION	ROW OPTION
------------	------------	-------------------------	-------------------	-----------------------	-------------------

02 thru 36

-04
= Standard Lead

-24
= Low Insertion Force

-L
= 10 μ" (0.25 μm)
Gold contact,
Matte Tin on tail

-G
= 20 μ" (0.51 μm)
Gold contact,
Gold Flash on tail

-T
= Matte Tin
(Not available with
Low Insertion Force)

-S
= Single Row

-D
= Double Row

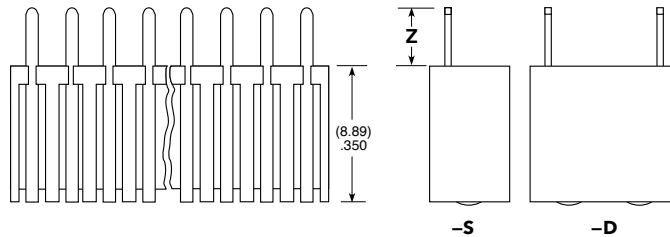
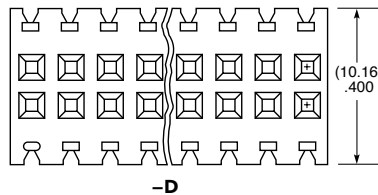
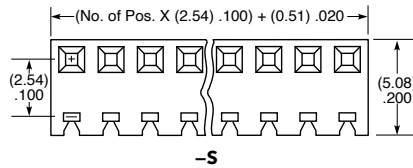

ROW OPTION	Z
-S	(4.31) .170
-D	(4.32) .170

APPLICATIONS

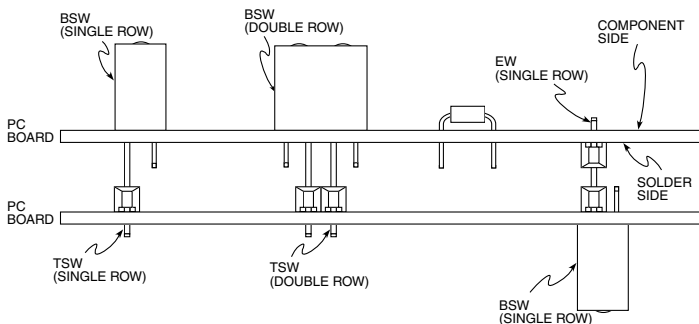

Note:

Some lengths, styles and options are non-standard, non-returnable.

LOW PROFILE SOCKET STRIPS

(2.54 mm) .100" PITCH • SLW/CES SERIES

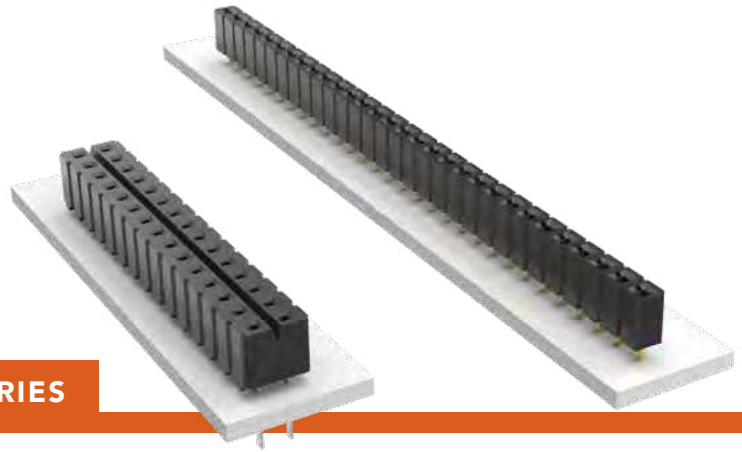

SLW

Mates:

TLW, TSW, MTLW, MTSW,
HW, EW, ZW, HTSW,
HMTSW, TSM

CES

Mates:

TLW, TSW, MTLW,
MTSW, HW, EW, ZW,
DW, HTSW, PHT, HMTSW

SLW	-	1	NO. PINS PER ROW	-	01	PLATING OPTION	-	ROW OPTION
-----	---	---	------------------	---	----	----------------	---	------------

01 thru 50



-F

= Gold flash on contact,
Matte Tin on tail

-S

= Single Row

-L

= 10 μ" (0.25 μm) Gold on contact,
Matte Tin on tail

-D

= Double Row

-G

= 20 μ" (0.51 μm) Gold on contact,
Gold flash on balance

-T

= Matte Tin

SPECIFICATIONS

Insulator Material:

Black G.F. Polyester

Contact Material:

Phosphor Bronze

Plating:

Au or Sn over
50 μ" (1.27 μm) Ni

SLW Current Rating (SLW/TSW):

5.2 A per pin
(2 pins powered)

CES Current Rating (TSW/CES):

5.5 A per pin
(2 pins powered)

Voltage Rating:

SLW: 406 VAC
CES: 400 VAC

Operating Temp Range:

-55 °C to +125 °C with Gold
-55 °C to +105 °C with Tin

Insertion Depth:

SLW: (2.16 mm) .085" to
(2.92 mm) .115"
CES: (2.62 mm) .103" to
(4.06 mm) .160"

Lead-Free Solderable:

No, Lead Wave only

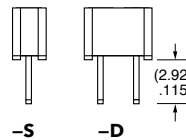
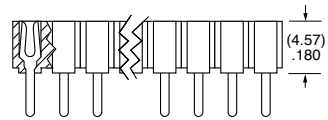
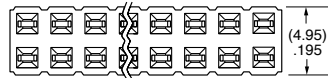
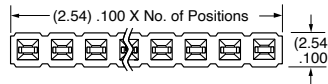

PROCESSING

Lead-Free Solderable:

No, Lead Wave only

CES	-	1	NO. PINS PER ROW	-	LEAD STYLE	-	PLATING OPTION	-	ROW OPTION	-	RA OPTION
-----	---	---	------------------	---	------------	---	----------------	---	------------	---	-----------

01 thru 50

Specify
LEAD
STYLE
from
chart

-L

= 10 μ" (0.25 μm)
Gold contact,
Matte Tin on tail

-S

= Single Row

-RA

= Right-angle
version
(Style -02 only
Single Row only)

-T

= Matte Tin

-D

= Double Row

ALSO AVAILABLE

MOQ Required

Other Platings

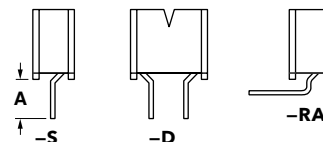
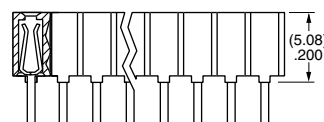
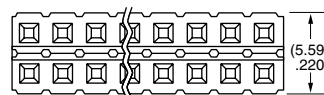
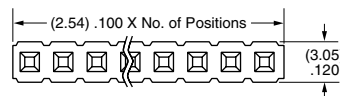

LEAD STYLE	A
-01	(3.25) .128
-02	(5.66) .223

Note:

Some lengths, styles and
options are non-standard,
non-returnable.

SHUNTS & JUMPERS



(2.54 mm) .100" PITCH • SNT/MNT/2SN/SNM/PK/JL SERIES

SNT/MNT

Mates:

TSW, HTSW, MTSW, HMTSW, TLW, DW, EW, ZW, HW, TSM, BST, PHT

2SN

Mates:

TMMH, TMM, MTMM, MMT, TW, LTMM, ZLTMM, TSH, EHT

SNM

Mates:

TMS, MTMS, DWM

SPECIFICATIONS

SNT

Insulator Material:

Glass Filled Polyester

Contact Material:

Phosphor Bronze

Current Rating (SNT/TSW):

4.3 A per pin

(1 pin powered per row)

Operating Temp Range:

-55 °C to +125 °C

Insertion Depth:

(4.32 mm) .170" minimum

Lead Size accepted:

(0.64 mm) .025" SQ

MNT

Same as SNT except:

Current Rating (MNT/TSM):

3.9 A per pin

(1 pin powered per row)

Working Voltage:

450 VAC

2SN

Same as SNT except:

Insertion Depth:

(2.29 mm) .090" minimum

Lead Size accepted:

(0.51 mm) .020" SQ

SNM

Same as SNT except:

Insertion Depth:

(3.43 mm) .135" minimum

Max Processing Temp:

Not recommended for IR/VP

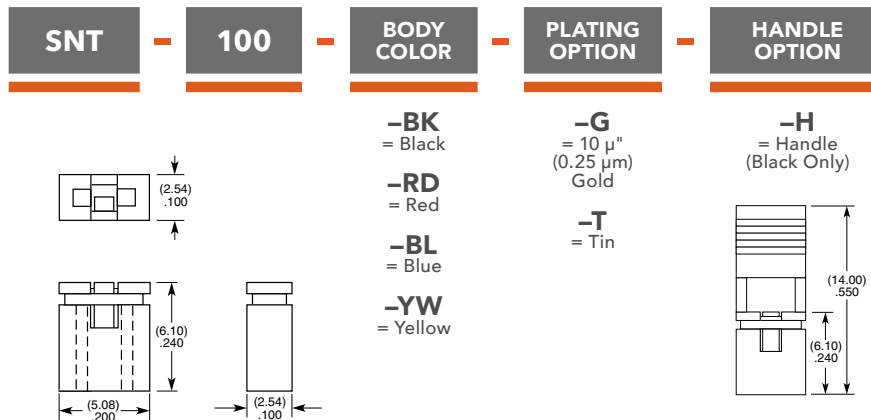

Note:
Other Gold plating options available.

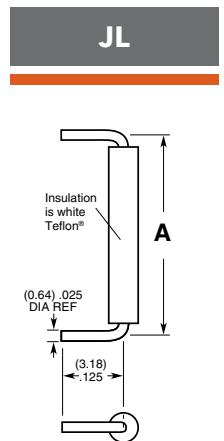
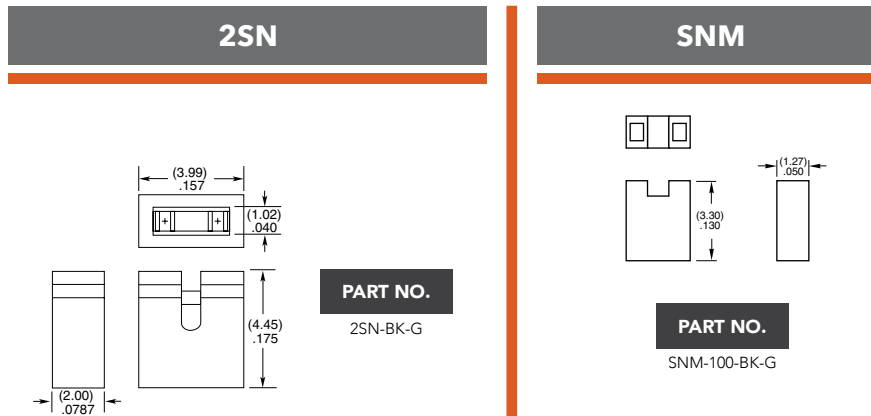
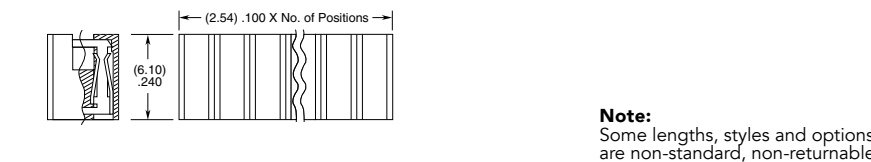
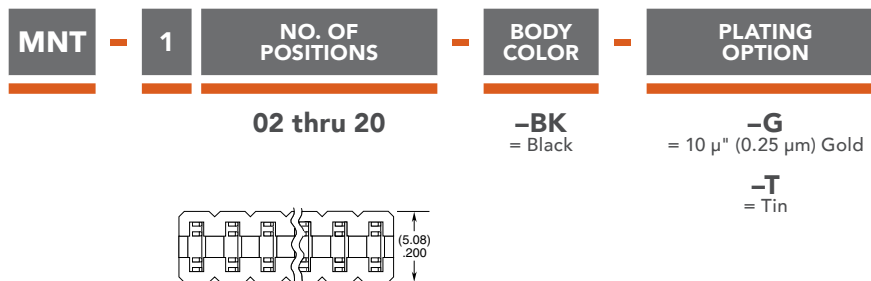

PART NO.	A
JL-100-25-T	(2.54) .100
JL-250-25-T	(6.35) .250
JL-400-25-T	(10.16) .400

Note:
For complete specifications see www.samtec.com?JL



PART NO.	A	B
PK-01-06	(0.64) .025 SQ	(5.84) .230
PK-01-07	(0.51) .020 SQ	(3.18) .125

Insulator Material:
Natural Thermoplastic

Note:
Order per wheel.
6 pins per wheel.

IDC/FLAT FLEXIBLE CABLE SYSTEMS

TIGER EYE™ CONTACTS • MULTIPLE PITCHES • LOW PROFILE • SHROUDED EJECTOR TERMINALS

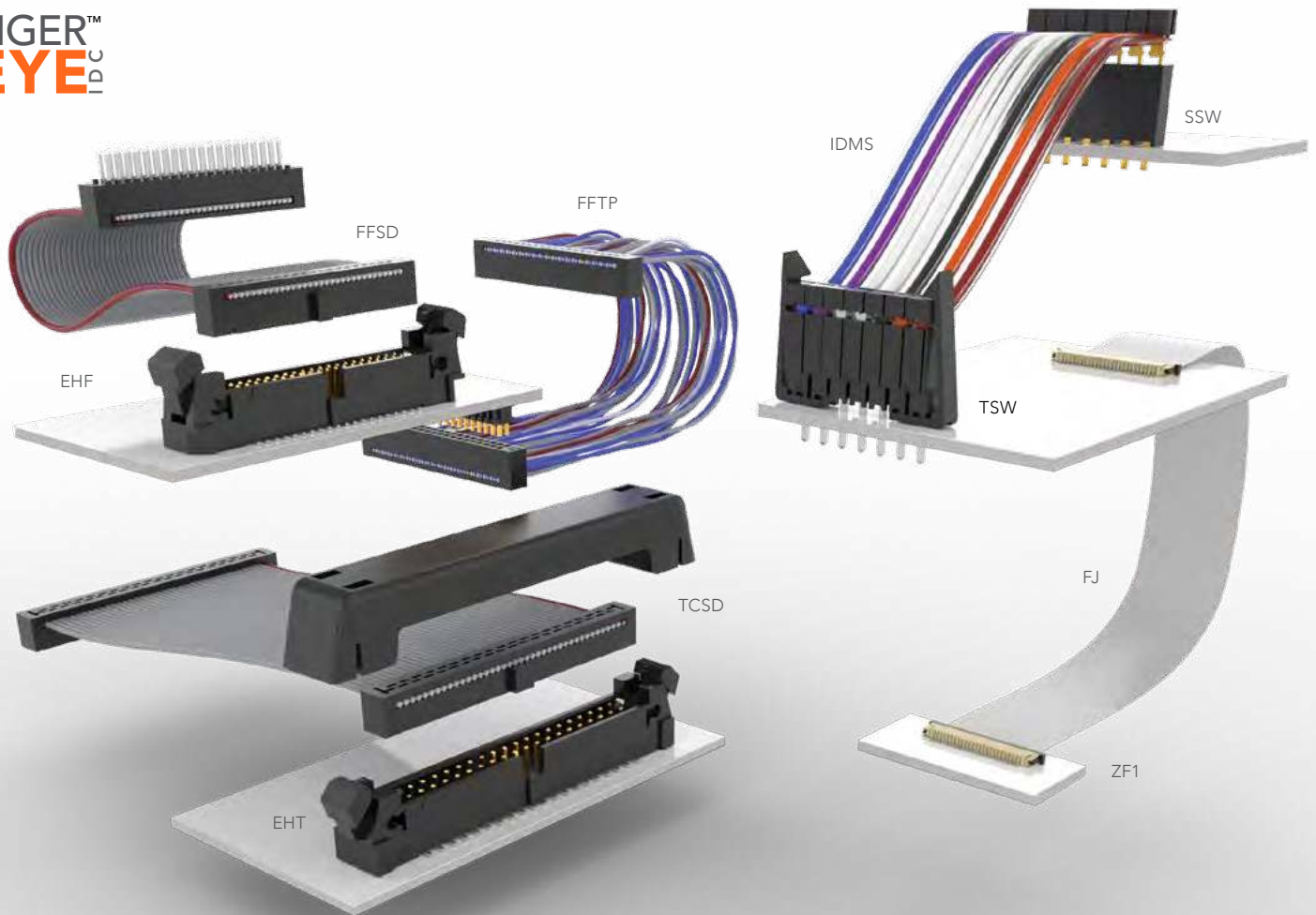

314-325

IDC ASSEMBLIES AND HEADERS

.100" (2.54 mm) Pitch (IDSX, IDMX, EJH, TST, HTST, ZST)	314-317
2.00 mm (.0787") Pitch (TCSD, TCMD, EHT, EC2, STMM, ZSTMM, ETMM)	318-321
.050" (1.27 mm) Pitch (FFSD, FFMD, FFTP, FMTP, EHF, SHF, ESHF)	322-325

326

FLEX JUMPERS

0.50 mm (.0197") Pitch FFC Jumper & Sockets (FJH, ZF5S)	326
---	-----

SLIM BODY FLAT RIBBON IDC CABLES



(2.54 mm) .100" PITCH • IDSS/IDSD/IDMS/IDMD SERIES

IDSS/IDMS/IDMD

Mates:

TSW, MTSW, TSM, EJH, PHT, HMTSW, HTSW, HW, DW, EW, ZW, MTLW

IDSD

Mates:

TST, HTST, ZST, EJH

SERIES	ROW OPTION	NO. PINS PER ROW
IDM = Standard Tail Male Plug	S = Single	-02 thru -32 = IDMS/IDMD
IDS = Socket	D = Double (Color coded cable Not available for 31 thru 36 pins/row. See -G option.)	-02 thru -36 = IDSS/IDSD

SPECIFICATIONS

Insulator Material:

Black Glass Filled Polyester

Contact (IDSS/IDSD):

BeCu

Terminal (IDMS/IDMD):

Phosphor Bronze

Plating:

Au over 50 μ " (1.27 μ m) Ni or Sn over 100 μ " (2.54 μ m) Cu or 50 μ " (1.27 μ m) Ni

Wire:

28 AWG 7/36 stranded
Tinned Copper Web footer

Current Rating (IDMD):

3 A per pin
(2 pins powered)

Temperature Range:

-20 °C to +105 °C

(Rainbow Cable)

-40 °C to +105 °C

(Gray Cable)

Voltage Rating:

425 VAC/600 VDC

Lead Size Range:

(0.56 mm) .022" SQ to

(0.71 mm) .028" SQ

Lead Insertion Depth:

(5.59 mm) .220" to

(6.22 mm) .245"

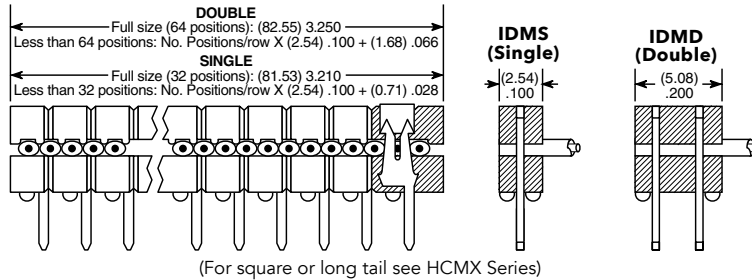

IDMX shown

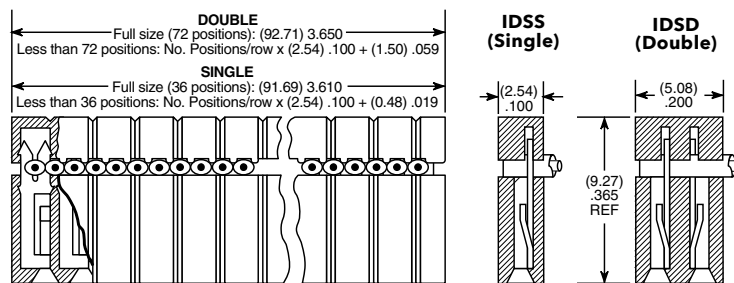

IDSX shown

ALSO AVAILABLE

Molded-To-Position IDC Assemblies

Low Profile

Skinny side locks

Dual beam contacts

Single and double row

(6.35mm) .025" square and

(5.84mm) .230" length tail available

Visit samtec.com?HCSD, samtec.com?HCSS,

samtec.com?HCMD or samtec.com?HCMS

for more detailed information.

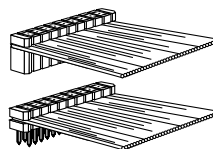
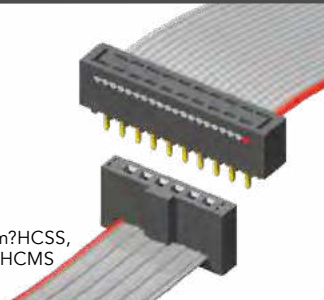

Single End (-S)

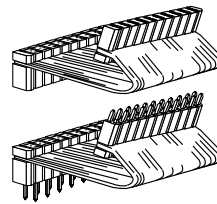

Double End (-D)

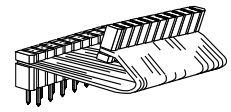

Transfer End (-T)

Note:

This Series is non-standard, non-returnable.



END ASSEMBLY

ASSEMBLED LENGTH

OPTION

-S
= Single End
(Socket or Male Plug on one end)

-D
= Double End
(Socket or Male Plug on each end)

-T
= Transfer End
(Male Plug on one end with socket on other.
Begin part number with IDM)

-"XX.XX"
= Assembled Length

-T
= Tin Plating
(Both Ends)

-C
= Tin IDM,
10 μ" (0.25 μm) Gold IDS
(-T End Assembly Required)

-A
= Tin IDS,
10 μ" (0.25 μm) Gold IDM
(-T End Assembly Required)

-P "XX"
= Polarized
Specify "XX" as position.
For Double the same position
will be polarized on both ends.
(Not available on IDM unless transfer,
then only the socket is polarized.)

-G
= Gray Cable
Specify -G for Gray cable.
Gray cable has one red edge.
IDSS and IDMS uses
(2.54 mm) .100" centerline cable.
IDSD and IDMD uses
(1.27 mm) .050" centerline cable.
Cable is 28 AWG 7/36 copper wire.
Standard cable is same as
above except color

-ST "X"
= Stripped & Tinned
(Specify Suffix from table)
(All dimensions are ± 1/16" (1.59 mm)
(Not available in 28 positions and higher)

-B "XX"
= Breakout
(Specify "XX" as number of
conductors to be broken out)
(Breakout starts with Number 1 lead
indicated by brown wire or red stripe.
Shown on top side)

-RW
= Reverse Wiring
(#1 wire opposite position #1)

-S "XX"
= Daisy Chain, Single
(When mating double row
connector with two single row
connectors, the outer most single will
be connected to Conductor #1 and
the inside single to Conductor #2)

-D "XX"
= Daisy Chain, Double

-W "XX"
= Wiring Reverse Daisy Chain, Single
(Same as -S "XX" except outer strip
connected to Conductor #2 and inside
strip connected to Conductor #1)

-R
= Reversed

-M
= Middle Reversed
(Requires -SXX, -WXX or -DXX)

-O
= Outside Reversed
(Requires -SXX, -WXX or -DXX)

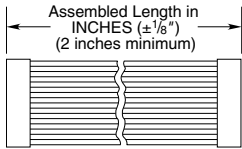

Assembled Length (-"XX.XX")

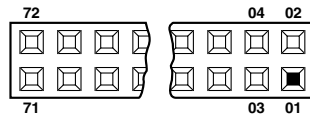

Polarized (-P "XX")

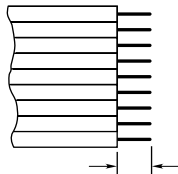

-ST8	1/8" (3.18)
-ST4	1/4" (6.35)
-ST2	1/2" (12.70)
-ST3	3/8" (9.53)

Stripped & Tinned (-ST "X")

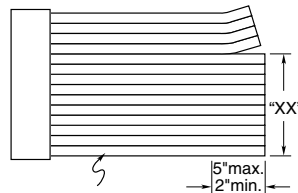

Breakout starts with
Number 1 lead indicated
by brown wire or red stripe.
Shown on top side.

Breakout (-B "X")

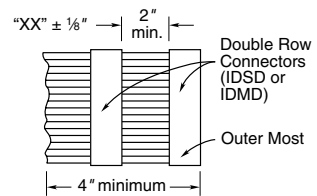

Daisy Chain Single (-S "XX")

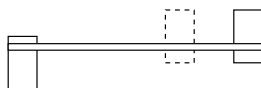

Reversed (-R)

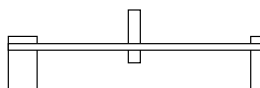

Middle Reversed (-M)

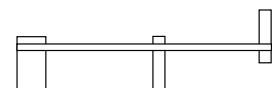

Outside Reversed (-O)

SHROUDED IDC EJECTOR HEADERS

(2.54 mm) .100" PITCH • EJH SERIES

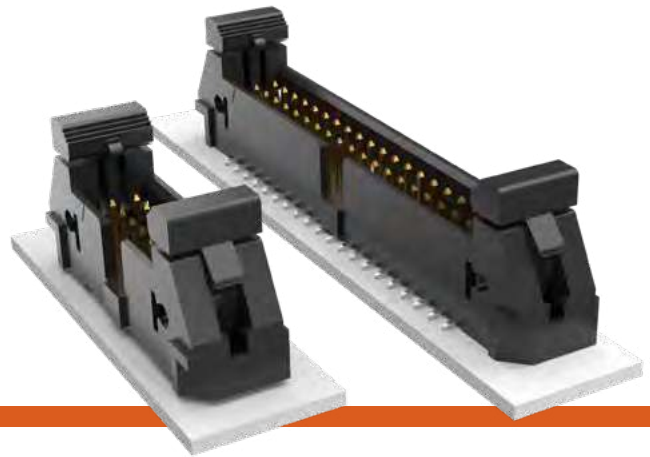

EJH

Mates:

IDSD (EJH-01 Required),
HCSD (EJH-02 Required)

SPECIFICATIONS

Insulator Material:

-01=Black LCP

-02=Natural LCP

Terminal Material:

Phosphor Bronze

Plating:

Sn or Au over 50 μ" (1.27 μm) Ni

Operating Temp Range:

-55 °C to +125 °C

PROCESSING

Lead-Free Solderable:

Yes

SMT Lead Coplanarity:

(0.10 mm) .004" max

ALSO AVAILABLE

MOQ Required

Other sizes

Other platings

EJH	1	NO. PINS PER ROW	LEAD STYLE	PLATING OPTION	D	TAIL OPTION	OTHER OPTION
-----	---	------------------	------------	----------------	---	-------------	--------------

05, 07,
08, 10,
13, 15,
17, 20, 25
(Standard sizes)

-01
= Standard
(Mates to IDSD)

-02
= Extended
(Mates to HCSD)

-F
= Gold flash
on post,
Matte Tin
on tail

-L
= 10 μ"
(0.25 μm)
Gold on post,
Matte Tin
on tail

-SM
= Surface
Mount

-TH
= Through-hole

-RA
= Right-angle

-“XX”
= Polarized
Position

-LC
= Locking Clip
(-SM only)
(Manual
placement
required)

-K
= .475"
(12.00 mm)
DIA
Polyimide
Film Pick &
Place Pad
(-SM only)

-P
= Pick &
Place Pad
(-SM only)

-TR
= Tape &
Reel
(-SM only)
(25 position
not available)

-FR
= Full Reel
Tape & Reel
(must order
max. quantity
per reel;
contact
Samtec for
quantity
breaks)
(-SM only)
(25 position
not available)

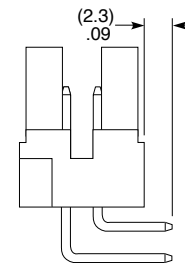
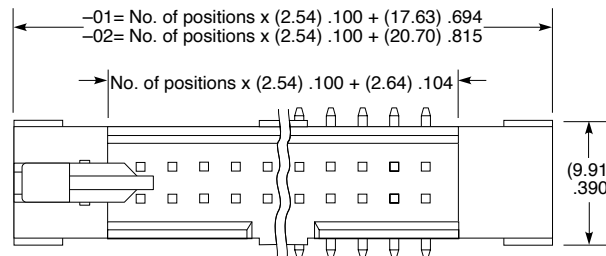

-RA OPTION

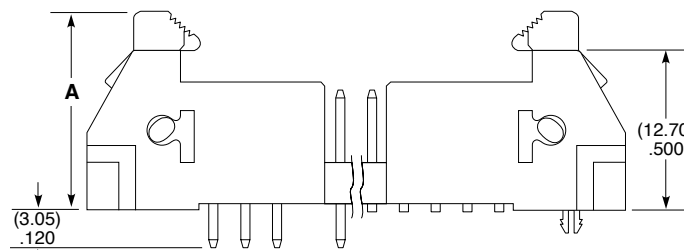

-LC OPTION

-TH OPTION

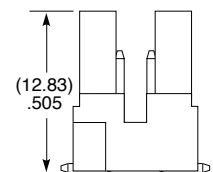

-SM OPTION

(Latch removed for clarity)

LEAD STYLE	A
-01	(16.88) .665
-02	(17.39) .685

Note:

Some lengths, styles and options are non-standard, non-returnable.

SHROUDED .025" SQ POST IDC HEADERS

(2.54 mm) .100" PITCH • TST/HTST/ZST SERIES

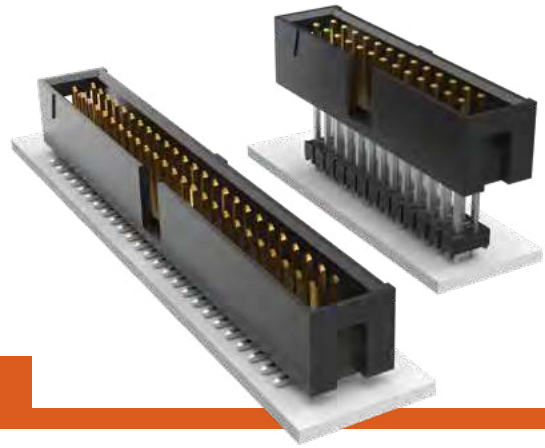

TST/HTST/ZST

Mates:
IDSD, HCSD

SPECIFICATIONS

Insulator Material:

TST, ZST=Black Glass Filled Polyester
HTST=Natural LCP

Insulation Resistance:

5000 MΩ min

Terminal Material:

Phosphor Bronze

Plating:

Au or Sn over
50 μ" (1.27 μm) Ni

Operating Temp Range:

-55 °C to +125 °C with Gold

-55 °C to +105 °C with Tin

Voltage Rating:

425 VAC/600 VDC

PROCESSING

Lead-Free Solderable:

HTST=Yes

TST, ZST= No, Lead Wave only

SMT Lead Coplanarity:

(0.10 mm) .004" max (05-15)

(0.15 mm) .006" max (17-36)*

*(.004" stencil solution may be available; contact ipg@samtec.com)

SERIES	1	NO. PINS PER ROW	LEAD STYLE	PLATING OPTION	ROW OPTION	OTHER OPTION
--------	---	------------------	------------	----------------	------------	--------------

TST
= Cable Strip

HTST
= High Temp Cable Strip

05, 07, 08, 10, 12, 13, 15, 17, 20, 25, 32, 36
(Standard sizes)

Specify **LEAD STYLE** from chart

-F
= Gold flash on post, Matte Tin on tail
(Not available on -DV)

-L
= 10 μ" (0.25 μm) Gold on post, Matte Tin on tail

-T
= Matte Tin

-D
= Double Row Through-hole (lead style -01, -02 & -03 only)

-DV
= Double Row Surface Mount (lead style -01 only) (HTST only)

-D-RA
= Double Row Right-angle (lead style -04 & -05 only)

Surface Mount (lead style -01 only) (HTST only)

-P
= Pick & Place Pad

-TR
= Tape & Reel

-FR
= Full Reel Tape & Reel (must order max. quantity per reel; contact Samtec for quantity breaks)

LEAD STYLE	THROUGH-HOLE (A)
-01	(2.92) .115
-02	(4.19) .165
-03	(14.35) .565

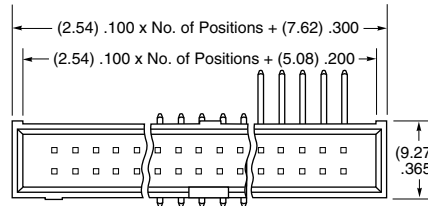

-D -DV -D-RA

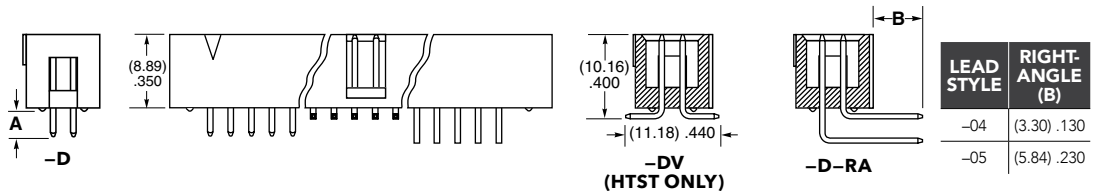

ALSO AVAILABLE

MOQ Required

Other platings & sizes

Alignment Pins

Single Row

Locking Leads

Polarized

ZST	1	NO. PINS PER ROW	LEAD STYLE	PLATING OPTION	D	BODY HEIGHT
-----	---	------------------	------------	----------------	---	-------------

05, 07, 08, 10, 12, 13, 15, 17, 20, 25, 32, 36
(Standard sizes)

Specify **LEAD STYLE** from chart

-F
= Gold flash on post, Matte Tin on tail

-L
= 10 μ" (0.25 μm) Gold on post, Matte Tin on tail

-T
= Matte Tin

-"XXXX"
= Body Height

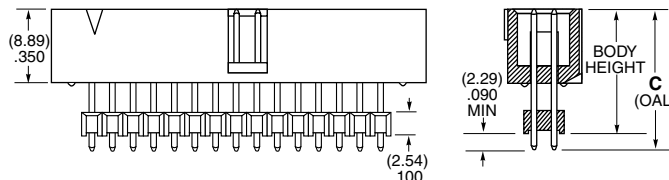
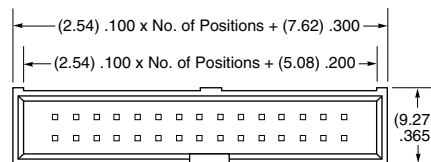

Note:
Some lengths, styles and options are non-standard, non-returnable. ZST is non-standard, non-returnable.

Note:
For added mechanical stability, Samtec recommends mechanical board spacers be used in applications with gold or selective gold plated connectors. Contact ipg@samtec.com for more information.

TIGER EYE™ IDC SOCKET CABLE

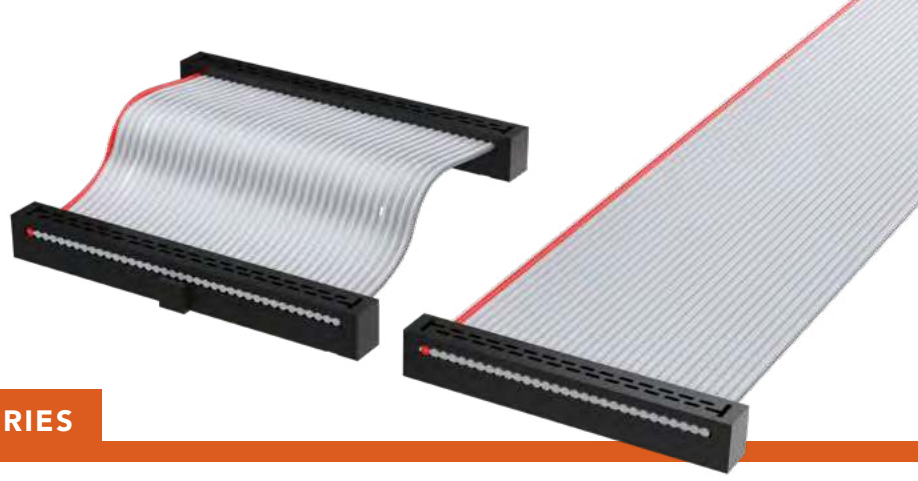

(2.00 mm) .0787" PITCH • TCSD SERIES

TCSD

Mates:

TMM, TMMH, STMM,
MMT, TW, MTMM, EHT,
ETMM (-SR), ZSTMM

SPECIFICATIONS

Insulator Material:

Black Glass Filled Polyester

Contact:

BeCu

Plating:

Au or Sn over

50 μ" (1.27 μm) Ni

Wire:

28 AWG 7/36 Stranded,

Tinned, Copper with

Gray PVC Insulator

Current Rating

(TCSD/STMM):

2.8 A per pin

(2 pins powered)

Operating Temp Range:

-40 °C to +105 °C

Lead Size Accepted:

(0.48 mm) .019" to

(0.53 mm) .021"

Insertion Depth:

(2.87 mm) .113" to

(3.17 mm) .125"

ALSO AVAILABLE

MOQ Required

Other sizes

Other platings

POLARIZING KEY

Specify PK-01-07 for polarizing key

(Available in wheels of six each).

Also polarizes SMM Series

socket strips.

SERIES	NO. PINS PER ROW	END OPTION	OVERALL LENGTH	01	PLATING OPTION	N	OTHER OPTION
TCSD = Socket Strip	-04, -05, -07, -08, -10, -12, -13, -15, -17, -20, -22, -25 (Standard sizes)	-S = Single End -D = Double End	- "XX.XX" = Assembled Length		Leave blank for standard plating 30 μ" (0.76 μm) Gold on contact area -F = Gold flash on contact	-N = Notch Polarization	-P "XX" = Position Polarization (Specify "XX" as position number. Same position will be polarized on both ends) -B "XX" = Breakout (Specify "XX" as number of conductors to be broken out) -RW = Reverse Wiring (Blue or black wire opposite position #1) -D "XX" = Daisy Chain -SR = Strain Relief (Not available with -O, -M, -R, -DXX or -BXX) -R = Reversed -M = Middle Reversed (Requires -DXX) -O = Outside Reversed (Requires -DXX)

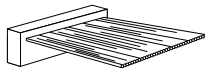
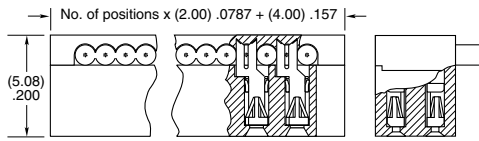
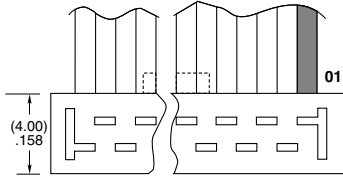

Single End (-S)

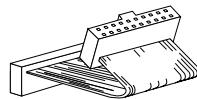

Double End (-D)

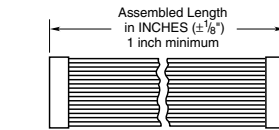

Assembled Length (-"XX.XX")

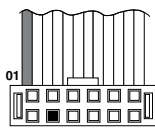

Position Polarization (-P "XX")

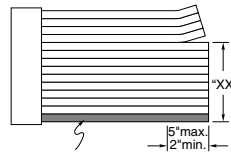

Breakout (-B "XX")

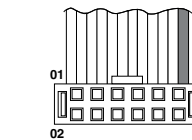

Reverse Wiring (-RW)

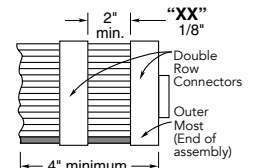

Daisy Chain (-D "XX")

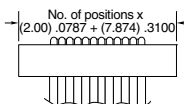

Strain Relief (-SR)



Reversed (-R)

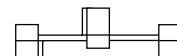

Middle Reversed (-M)



Outside Reversed (-O)

Note:

TCSD Series assemblies are non-standard, non-returnable.

HIGH-RELIABILITY IDC HEADER CABLE

(2.00 mm) .0787" PITCH • TCMD SERIES

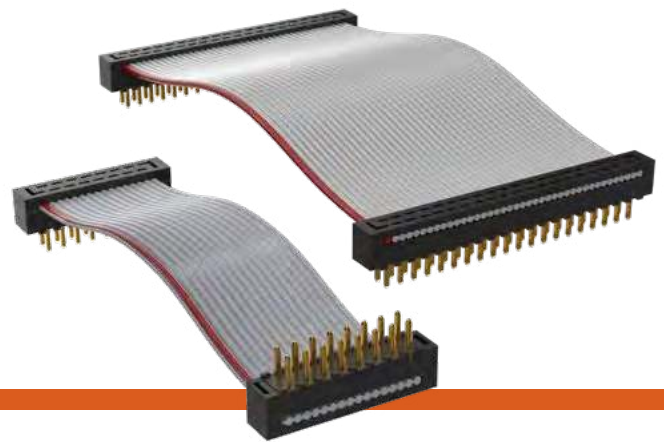

TCMD

Mates:

SMM*, MMS*, ESQT,
PTF, SQT, SQW, TLE

SPECIFICATIONS

Insulator Material:

Black Glass Filled Polyester

Terminal:

Phosphor Bronze

Plating:

Au or Sn over
50 μ" (1.27 μm) Ni

Wire:

28 AWG 7/36 Stranded, Tinned,
Copper with
Gray PVC Insulator

Current Rating:

2.6 A per pin
(2 pins powered)

Operating Temp Range:

-40 °C to +105 °C

ALSO AVAILABLE

MOQ Required

Other sizes



Single End (-S)

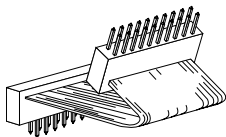

Double End (-D)

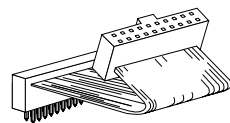

Transfer End (-T)

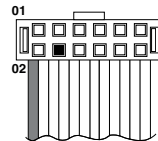

Position Polarization (-P "XX")

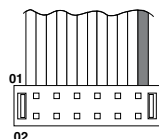

Reverse Wiring (-RW)

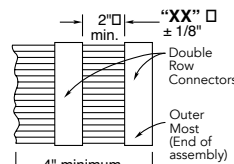

Daisy Chain (-D "XX")

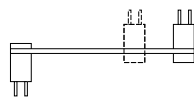

Reversed (-R)

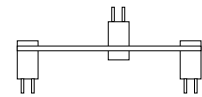

Middle Reversed (-M)

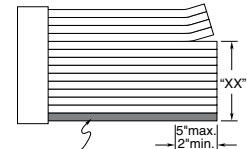

Breakout starts with Number 1 lead indicated by brown wire or red stripe. Shown on top side.

Breakout (-B "XX")

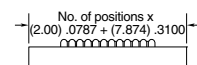

Strain Relief (-SR)

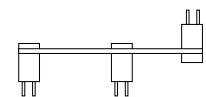

Outside Reversed (-O)

SERIES	NO. PINS PER ROW	END OPTION	OVERALL LENGTH	01	TRANSFER OPTION	OTHER OPTION
--------	------------------	------------	----------------	----	-----------------	--------------

TCMD
= Terminal Strip

-04, -05, -07
-08, -10, -12,
-13, -15, -17,
-20, -22, -25
(Standard sizes)

-S
= Single End

-D
= Double End

-T
= Transfer End

-"XX.XX"
= Assembled Length

Leave blank for
-S and -D
End Options.
For -T End
Option Specify
"-N"
(Socket has notch
polarization)

-P "XX"
= Position
Polarization
(Specify "XX" as
position number.
Requires Transfer
End. Only Socket
is polarized.)

-B "XX"
= Breakout
(Specify "XX"
as number of
conductors to
be broken out)

-RW
= Reverse Wiring
(Blue or black
wire opposite
position #1)

-D "XX"
= Daisy Chain

-SR
= Strain Relief
(Not available
with -O, -M, -R,
-DXX or -BXX)

-R
= Reversed

-M
= Middle Reversed
(Requires -DXX)

-O
= Outside
Reversed
(Requires -DXX)

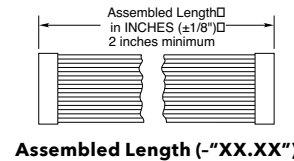

Assembled Length (-"XX.XX")

***Note:**
Standard TCMD callout will not mate with SMM, MMS. Must use gold plated callouts. (See drawing on web.)
When mated with a socket, Wire 1 mates with Pin 2; Wire 2 mates with Pin 1, etc.

Note:
TCMD Series assemblies are non-standard, non-returnable.

SHROUDED IDC HEADERS

(2.00 mm) .0787" PITCH • ETMM/EHT/EC2 SERIES

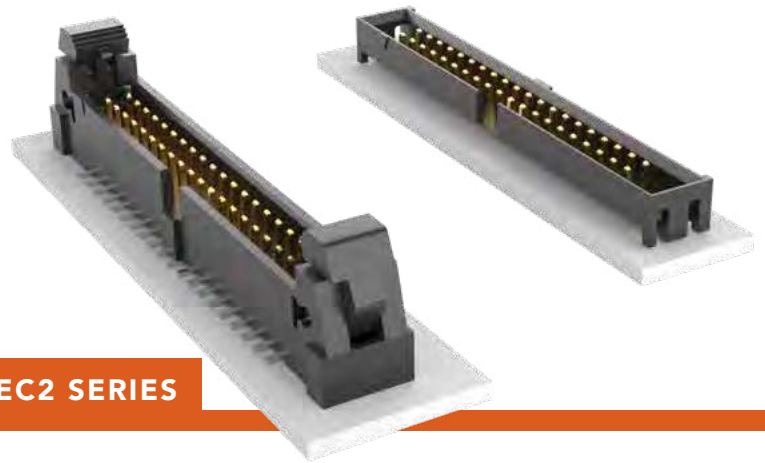

ETMM

Mates:
TCSD, TCMD

EHT

Mates:
TCSD

SPECIFICATIONS

Insulator Material:
Black Liquid Crystal Polymer
Terminal Material:
Phosphor Bronze
Plating:
Sn or Au over
50 μ" (1.27 μm) Ni
Operating Temp Range:
-55 °C to +125 °C

PROCESSING

Lead-Free Solderable:
Yes
SMT Lead Coplanarity:
EHT = (0.10 mm) .004" max
ETMM = (0.13 mm) .005" max*
*(.004" stencil solution
may be available; contact
ipg@samtec.com)

TYPE STRIP	1	NO. PINS PER ROW	02	PLATING OPTION	D	TAIL OPTION	OTHER OPTION
ETMM		05, 08, 10, 12, 13, 15, 17, 20, 22, 25 (Standard sizes)		-F = Gold Flash on post, Matte Tin on tail -L = 10 μ" (0.25 μm) Gold on post, Matte Tin on tail		-TH = Through-hole -RA = Right-angle -SM = Surface Mount	-“XX” = Polarized Position -LC = Locking Clip (N/A with -RA) (Manual placement required) -K = (7.50 mm) .295" DIA Polyimide Film Pick & Place Pad (-SM only) -TR = Tape & Reel (-SM only) -FR = Full Reel Tape & Reel (must order max. quantity per reel; contact Samtec for quantity breaks) (-SM only)

EHT	1	NO. PINS PER ROW	01	PLATING OPTION	D	TAIL OPTION	OTHER OPTION
EHT		05, 08, 10, 12, 13, 15, 17, 20, 22, 25		-F = Gold flash on post, Matte Tin on tail -L = 10 μ" (0.25 μm) Gold on post, Matte Tin on tail		Leave blank for Through-hole -RA = Right-angle -SM = Surface Mount	-“XX” = Polarized Position -SR = Strain Relief (Leave Blank for no strain relief) -LC = Locking Clip (-SM only) (Manual placement required) -K = (7.50 mm) .295" DIA Polyimide Film Pick & Place Pad (-SM only) -P = Pick & Place Pad (-SM only) -TR = Tape & Reel (-SM only) -FR = Full Reel Tape & Reel (must order max. quantity per reel; contact Samtec for quantity breaks) (-SM only)

EJECTOR HEADER CAP
(Locks TCSD cable to EHT header)

EC2 - NO. PINS PER ROW
05, 08, 10, 12, 13,
15, 17, 20, 22, 25

Note:
Some lengths, styles and
options are non-standard,
non-returnable.

SHROUDED IDC HEADER & STACKER

(2.00 mm) .0787" PITCH • STMM/ZSTMM SERIES

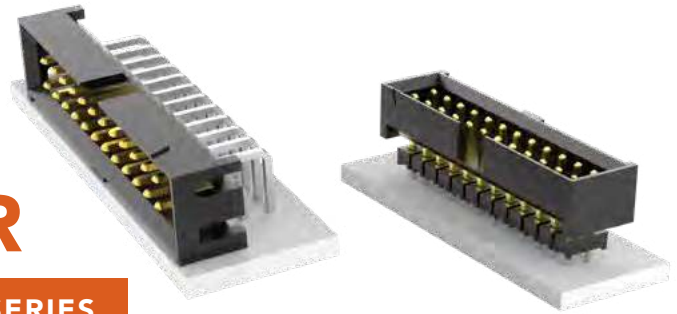

STMM/ZSTMM

Mates:
TCSD (except -SR)

SPECIFICATIONS

Insulator Material:
Black Liquid Crystal Polymer
Terminal Material:
Phosphor Bronze
Plating:
Sn or Au over
50 μ" (1.27 μm) Ni
Operating Temp Range:
-55 °C to +105 °C with Tin;
-55 °C to +125 °C with Gold

PROCESSING

Lead-Free Solderable:
Yes
SMT Lead Coplanarity:
(0.10 mm) .004" max

STMM	1	NO. PINS PER ROW	02	PLATING OPTION	D	TAIL OPTION	OTHER OPTION
		04, 05, 06, 07, 08, 10, 12, 13, 14, 15, 17, 20, 22, 25 (Standard sizes)		-F = Gold flash on post, Matte Tin on tail -L = 10 μ" (0.25 μm) Gold on post, Matte Tin on tail -T = Matte Tin		Leave blank for Through-hole -RA = Right-angle -SM = Surface Mount	-“XX” = Polarized Position -LC = Locking Clip (-SM only) (Manual placement required) -K = (7.50 mm) .295" DIA Film Pick & Place Pad (-SM only) -TR = Tape & Reel (-SM only) -FR = Full Reel Tape & Reel (must order max. quantity per reel; contact Samtec for quantity breaks) (-SM only)

ZSTMM	1	NO. PINS PER ROW	LEAD STYLE	PLATING OPTION	D	BODY HEIGHT	OTHER OPTION
		04, 05, 06, 07, 08, 10, 12, 13, 14, 15, 17, 20, 22, 25 (Standard sizes)	Specify LEAD STYLE from chart	-F = Gold flash on post, Matte Tin on tail -L = 10 μ" (0.25 μm) Gold on post, Matte Tin on tail -T = Matte Tin		-“XXX” = Body Height	-“XX” = Polarized Position

LEAD STYLE	A (OAL)	MAX BODY HEIGHT
-75	(9.58) 0.377	(7.42) 0.292
-62	(10.08) 0.397	(7.92) 0.312
-65	(10.49) 0.413	(8.33) 0.328
-73	(12.09) 0.476	(9.93) 0.391
-63	(14.10) 0.555	(11.94) 0.470
-66	(15.09) 0.594	(12.93) 0.509
-69	(15.60) 0.614	(13.44) 0.529
-74	(17.09) 0.673	(14.94) 0.588
-70	(17.60) 0.693	(15.44) 0.608
-71	(21.08) 0.830	(18.92) 0.745
-72	(21.62) 0.851	(19.46) 0.766

ALSO AVAILABLE

MOQ Required

Other sizes
Other platings

Notes:
For added mechanical stability, Samtec recommends mechanical board spacers be used in applications with gold or selective gold plated connectors. Contact ipg@samtec.com for more information.

This Series is non-standard, non-returnable.

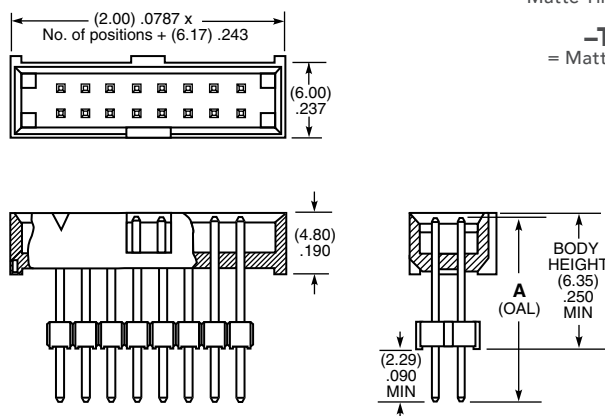

TIGER EYE™ FLAT IDC WIRE CABLES

(1.27 mm) .050" PITCH • FFSD SERIES

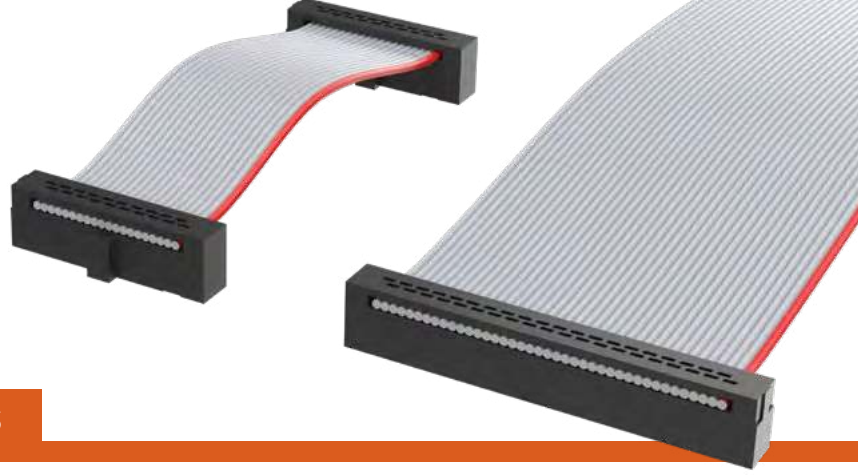

FFSD

Mates:

FTS, FTSH, EHF,
SHF, ESHF

SPECIFICATIONS

Insulator Material:

PBT

Contact:

BeCu

Plating:

10 μ" (0.25 μm) Au over 50 μ"
(1.27 μm) Ni on contact area;
Sn over 50 μ" (1.27 μm) Ni
on balance

Wire:

30 AWG

Current Rating (FFSD/FTSH):

2.3 A per pin
(2 pins powered)

Operating Temp Range:

-40 °C to +105 °C

Lead Size Accepted:

(0.41 mm) .016" SQ

Insertion Depth:

(2.64 mm) .104" to
(3.17 mm) .125"

ALSO AVAILABLE

MOQ Required

Other Sizes

SERIES	NO. PINS PER ROW	END OPTION	OVERALL LENGTH	01	N	OTHER OPTION
--------	------------------	------------	----------------	----	---	--------------

FFSD
= Socket Strip

-04, -05, -06, -08, -10, -11, -12, -13, -15, -17, -20, -25
(Standard sizes)

-S
= Single End
-D
= Double End

-"XX.XX"
= Assembled Length

-N
= Notch Polarization
(Notch option not available with -04 position)

-RW
= Reverse Wiring
(Red wire opposite position #1)

-D "XX"
= Daisy Chain

-SR
= Strain Relief
(Mates only with ESHF Series)
(Not available with -O, -M, -R or -DXX)

-R
= Reversed

-M
= Middle Reversed
(Requires -DXX)

-O
= Outside Reversed
(Requires -DXX)

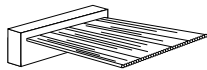
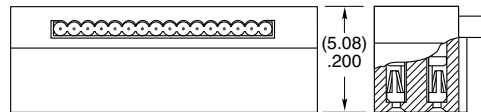
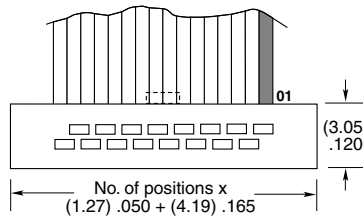

Single End (-S)

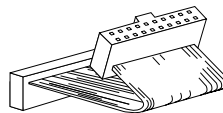

Double End (-D)

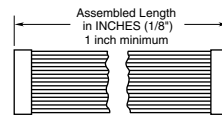

Assembled Length (-"XX.XX")

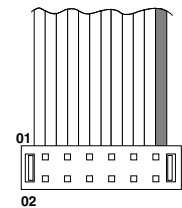

Reverse Wiring (-RW)

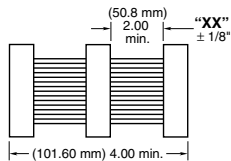

Daisy Chain (-D "XX")

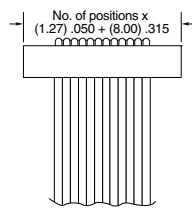

Strain Relief (-SR)

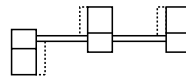

Reversed (-R)

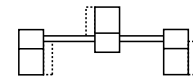

Middle Reversed (-M)

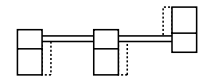

Outside Reversed (-O)

Note:
This Series is non-standard,
non-returnable.

TIGER EYE™ FLAT IDC WIRE CABLES

(1.27 mm) .050" PITCH • FFMD SERIES

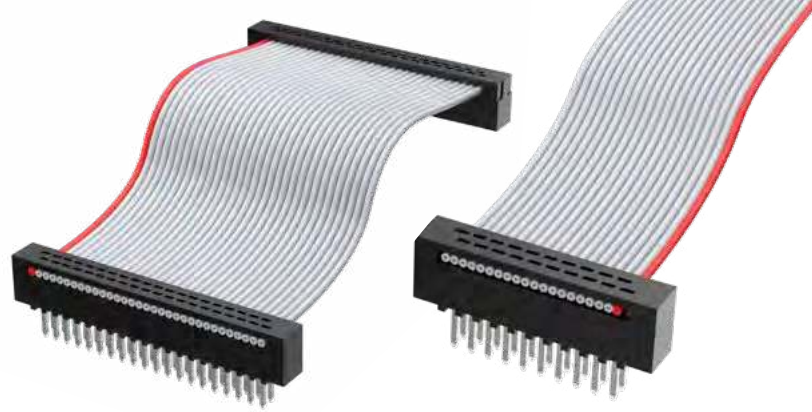

FFMD

Mates:
FLE*, SFMC*

TRANSFER END

Mates:
FTS, FTSH, EHF,
SHF, ESHF

SPECIFICATIONS

Insulator Material:

PBT
Terminal:
Phosphor Bronze
Contact:
BeCu (-T)
Plating:
Sn over 50 μ" (1.27 μm) Ni
Wire:
30 AWG
Current Rating:
2.5 A per pin
(2 pins powered)
Operating Temp Range:
-40 °C to +105 °C
Voltage Rating:
215 VAC / 304 VDC

ALSO AVAILABLE

MOQ Required

Other sizes

SERIES	NO. PINS PER ROW	END OPTION	OVERALL LENGTH	01	TRANSFER OPTION	OTHER OPTION
--------	------------------	------------	----------------	----	-----------------	--------------

FFMD
= Terminal Strip

-04, -05, -08, -10, -13, -17, -20, -25
(Standard sizes)

-S
= Single End
-D
= Double End
-T
= Transfer End

-"XX.XX"
= Assembled Length

Leave blank for -S and -D End Options.

-N
= Notch Polarization on socket (-T end only) (Not available with -04 position)

-RW
= Reverse Wiring (Red wire opposite position #1)

-D "XX"
= Daisy Chain

-SR
= Strain Relief (Mates only with ESHF Series) (Not available with -O, -M, -R or -DXX)

-R
= Reversed

-M
= Middle Reversed (Requires -DXX)

-O
= Outside Reversed (Requires -DXX)

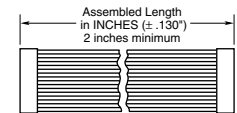
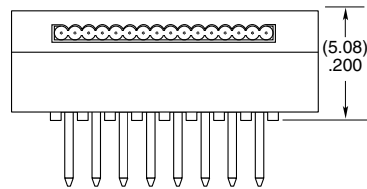
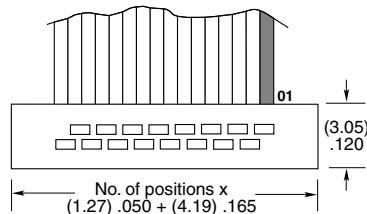

Assemble Length (-"XX.XX")



Single End (-S)

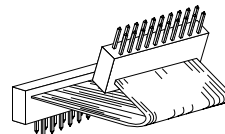

Double End (-D)

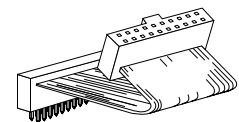

Transfer End (-T)

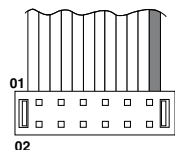

Reverse Wiring (-RW)

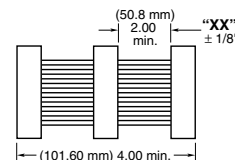

Daisy Chain (-D "XX")

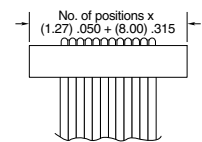

Strain Relief (-SR)

*Note:

Standard FFMD callout will not mate with FLE, SFMC. Must use gold plated callouts. (See drawing on web.) When mated with a socket, Wire 1 mates with Pin 2; Wire 2 mates with Pin 1, etc.

Note:

This Series is non-standard, non-returnable.

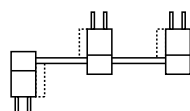

Reversed (-R)

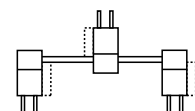

Middle Reversed (-M)

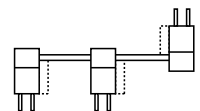

Outside Reversed (-O)

SHROUDED AND EJECTOR IDC HEADER

(1.27 mm) .050" PITCH • SHF/ESHF/EHF/ECF SERIES

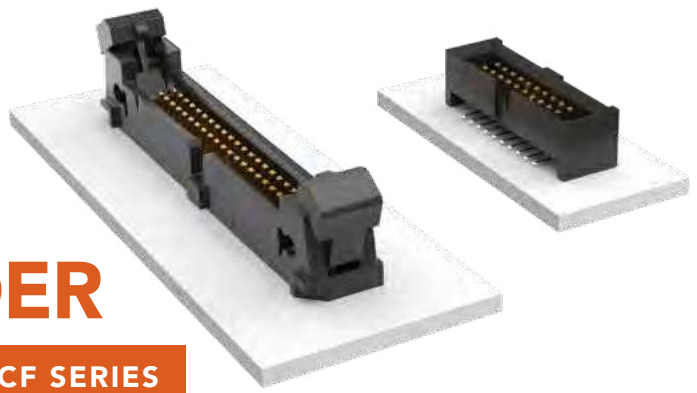

SHF/ESHF

Mates:
FFSD, FFTP (SHF)

EHF

Mates:
FFSD*, FFTP

***Important Note:**
EHF will not mate to FFSD with strain relief (-SR option), see ESHF series.

SERIES	1	NO. PINS PER ROW	01	PLATING OPTION	D	TAIL OPTION		OTHER OPTION	
--------	---	------------------	----	----------------	---	-------------	--	--------------	--

SHF = Mates with FFSD without Strain Relief	04, 05, 06, 08, 10, 11, 12, 13, 15, 17, 20, 25 (Standard sizes)	-L = 10 μ" (0.25 μm) Gold on post, Matte Tin on tail	-TH = Through-hole	-LC = Locking Clip (Not available with -RA) (Manual placement required)
ESHF = Mates with FFSD with Strain Relief			-RA = Right-angle	-K = (6.50 mm) .256" DIA Polyimide Film Pick & Place Pad (-SM only)
			-SM = Surface Mount	-TR = Tape & Reel

SPECIFICATIONS

Insulator Material:
Black Liquid Crystal Polymer
Terminal Material:
Phosphor Bronze
Plating:
Sn or Au over 50 μ" (1.27 μm) Ni
Operating Temp Range:
-55 °C to +125 °C

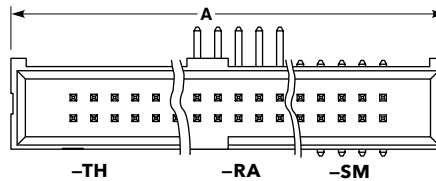

TYPE STRIP	A
SHF	No. of pins x (1.27) .050 + (6.35) .250
ESHF	No. of pins x (1.27) .050 + (10.16) .400

-FR
= Full Reel Tape & Reel (must order max. quantity per reel; contact Samtec for quantity breaks)

PROCESSING

Lead-Free Solderable:
Yes
SMT Lead Coplanarity:
(0.10 mm) .004" max

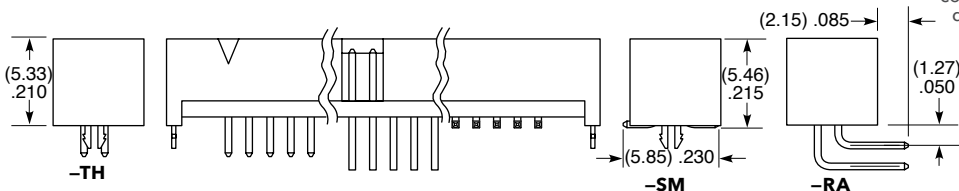

EHF	1	NO. PINS PER ROW	01	PLATING OPTION	D	TAIL OPTION		OTHER OPTION	
-----	---	------------------	----	----------------	---	-------------	--	--------------	--

04, 05, 08, 10, 13, 17, 20, 25
(Standard sizes)

-F
= Gold flash on post, Matte Tin on tail

-L
= 10 μ" (0.25 μm) Gold on post, Matte Tin on tail

Leave blank for Through-hole version

-SM
= Surface Mount

-RA
= Right-angle

"XX"
= Polarized Position (-RA not available)

-LC
= Locking Clip (-SM only) (Manual placement required)

-K
= (7.50 mm) .295" DIA Polyimide Film Pick & Place Pad

-P
= Pick & Place Pad (-SM only)

-TR
= Tape & Reel (-LC not available)

-FR
= Full Reel Tape & Reel (must order max. quantity per reel; contact Samtec for quantity breaks) (-LC not available)

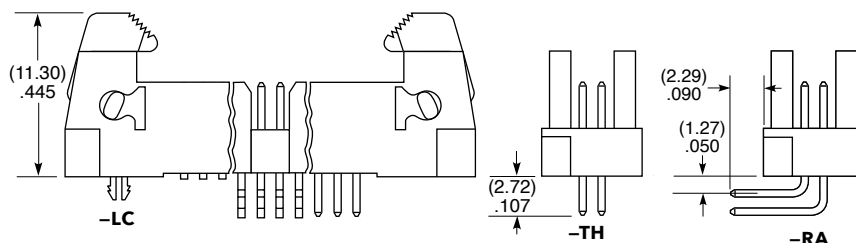
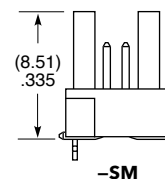
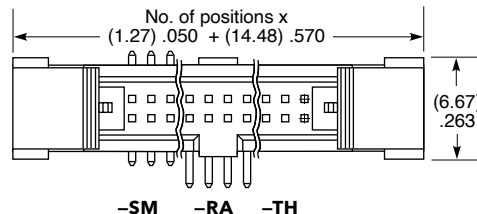

EJECTOR HEADER CAP

(Locks FFSD cable to EHF header)

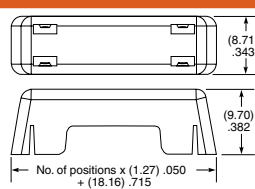

ECF - **NO. PINS PER ROW**

05, 08, 10, 13, 17, 20, 25

Note:
Some lengths, styles and options are non-standard, non-returnable.

TWISTED PAIR IDC CABLES

(1.27 mm) .050" PITCH • FFTP/FMTP SERIES

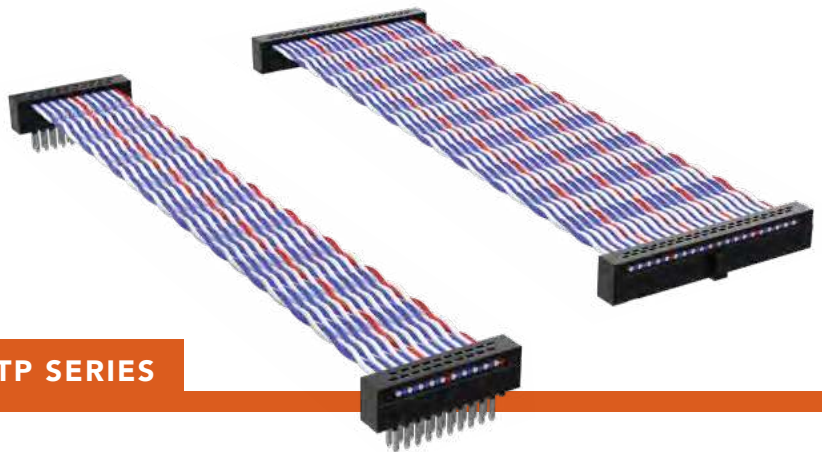

FFTP

Mates:
FTS, FTSH, EHF, SHF

FMTP

Mates:
FLE*, SFMC*

SPECIFICATIONS

Insulator Material:

PBT

Contact:

FFTP=BeCu

Terminal:

FMTP=Phosphor Bronze

Plating (FFTP):

FFTP=10 μ" (0.25 μm)

Au over 50 μ" (1.27 μm)

Ni on contact area; Sn over

50 μ" (1.27 μm) Ni

FMTP=Sn over 50 μ"

(1.27 μm) Ni on balance

Wire:

30 AWG 7/38, Tinned,
Twisted Pair with PVC insulator

Operating Temp Range:

-40 °C to +105 °C

Lead Size Accepted:

(0.41 mm) .016" SQ

Insertion Depth (FFTP):

FFTP=(2.64 mm) .104" to

(3.17 mm) .125"

FFTP	NO. PINS PER ROW	END ASSEMBLY	ASSEMBLY LENGTH	01	N	OPTION
	-05, -08, -10, -13, -17, -20, -25 (Standard sizes)	-D = Double End	-03.85 = (97.79 mm) 3.85" -08.77 = (222.76 mm) 8.77" -18.00 = (457.20 mm) 18.00" (Standard lengths)		-N = Notch Polarization (Standard)	-R = Reverse Connector

ALSO AVAILABLE

MOQ Required

Other sizes

FMTP	NO. PINS PER ROW	END ASSEMBLY	ASSEMBLY LENGTH	01	TRANSFER OPTION	OPTION
	-05, -08, -10, -13, -17, -20, -25 (Standard sizes)	-D = Double End -T = Transfer End	-03.85 = (97.79 mm) 3.85" -08.77 = (222.76 mm) 8.77" -18.00 = (457.20 mm) 18.00" (Standard lengths)		Leave blank for -D End Assembly. For -T End Assembly Specify "-N" (Socket has notch polarization)	-R = Reverse Connector

***Note:** Standard FMTP callout will not mate with FLE, SFMC. Must use gold plated callouts. (See drawing on web.)
When mated with a socket, Wire 1 mates with Pin 2; Wire 2 mates with Pin 1, etc.

Note:
This Series is non-standard, non-returnable.

FLAT FLEXIBLE CABLE (FFC) JUMPER & SOCKET



(0.50 mm) .0197" PITCH • FJH/ZF5S SERIES

FJH
Mates:
ZF5S

FJH	NO. OF POSITIONS	STYLE	LENGTH	STRIP LENGTH
-----	------------------	-------	--------	--------------

SPECIFICATIONS

Conductor:
Tin Plated Copper
Conductor Resistance:
1000 Ω/km max
Current Rating:
1.8 A per pin
(1 pin powered)
Operating Temp Range:
-55 °C to +80 °C
Voltage Rating:
195 VAC

ALSO AVAILABLE
MOQ Required

Other Platings

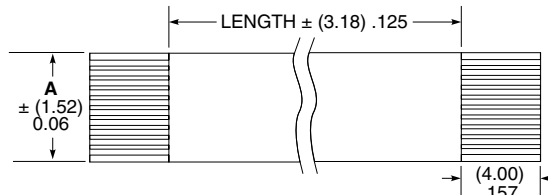

Length in inches

-03.00
= (76.2 mm) 3.00"

-06.00
= (152.4 mm) 6.00"

-12.00
= (304.8 mm) 12.00"

-24.00
= (609.6 mm) 24.00"

(Standard Lengths)

-4
= (4.00 mm)
.157"

NO. OF POSITIONS	A
-10	(5.50) .217
-15	(8.00) .315
-20	(10.50) .413
-25	(13.00) .512
-30	(15.50) .610
-40	(20.50) .807
-43	(22.00) .866
-50	(25.50) 1.00

-D STYLE

-R STYLE

Notes:
Stiffener color will be blue or black at Samtec's discretion.
Some sizes, styles and options are non-standard, non-returnable.

OTHER SOLUTIONS

For 1.00 mm pitch flat flexible cable series, visit:
www.samtec.com?FJ
www.samtec.com?ZF1
www.samtec.com?FC1

ZF5S
Mates:
FJH

ZF5S	NO. OF POSITIONS	LEAD STYLE	PLATING OPTION	WT	OPTION
------	------------------	------------	----------------	----	--------

SPECIFICATIONS

Insulator Material:
Natural LCP
Contact Material:
Phosphor Bronze
Plating:
Sn over 50 μ" (1.27 μm) Ni
Weld Tab:
Phosphor Bronze
Operating Temp Range:
-55 °C to +105 °C
Current Rating:
1.8 A per pin
(1 pin powered)

PROCESSING

Lead-Free Solderable:
Yes
SMT Lead Coplanarity:
(0.10 mm) .004" max (10-30)
(0.15 mm) .006" max (40-50)*
*(.004" stencil solution may be available; contact ipg@samtec.com)

Note:
Some sizes, styles and options are non-standard, non-returnable.

-10, -15, -20, -25, -30, -40, -43, -50
(Standard sizes)

-01
= Contact Bottom

-T
= Matte Tin

-WT
= Weld Tab

-K
= (3.00 mm) .118" DIA
Polyimide Film
Pick &
Place Pad

-TR
= Tape &
Reel

-FR
= Full Reel
Tape & Reel
(must order
max. quantity
per reel;
contact
Samtec for
quantity breaks)

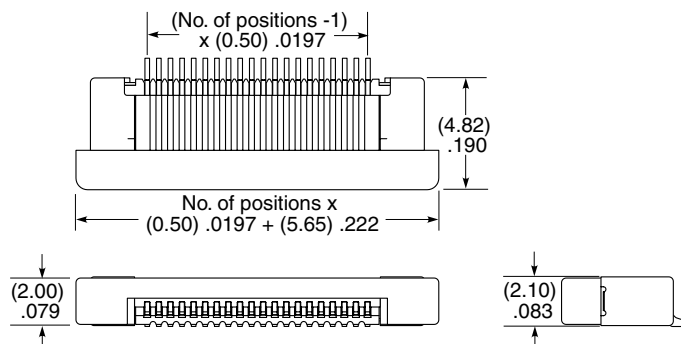

ALSO AVAILABLE
MOQ Required

Vertical
Contact top
Other positions

RUGGED FEATURES

OPTIONS FOR HIGH-RELIABILITY, HIGH-RETENTION AND HIGH-CYCLE LIFE

RUGGEDIZING OPTIONS



JACK SCREWS

Ideal for high normal force, zippering and other rugged applications



POSITIVE LATCHING

Manually activated latches increase unmating force by up to 200%

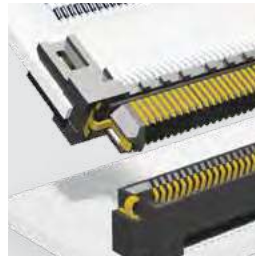

FRICTION LOCKS

Metal or plastic friction locks increase retention/withdrawal force



RETENTION PINS

Increase unmating force by up to 50%



BOARD LOCKS

Boards are mechanically locked together



WELD TABS

Significantly increase shear resistance of connector to PCB



GUIDE POSTS

Easy and secure mating



SHIELDING

360° shielding reduces EMI

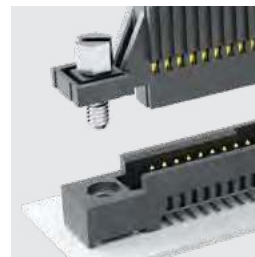

SCREW DOWNS

Secure mechanical attachment to the board



BOARD STANDOFFS

Precision machined standoffs for 5 mm to 30 mm board spacing

CONTACT SYSTEMS

TIGER EYE
CONTACT



High-reliability
High Mating Cycles
Multi-finger Contact

TIGER CLAW
CONTACT

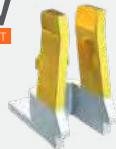

Dual Wipe Contact
Pass-through Applications
Ultra-low Profile

BLADE & BEAM
CONTACT



Mating/Alignment "Friendly"
Cost-effective
Micro Pitch

TIGER BEAM
CONTACT



Best Cost
Reliable Performance
Post & Beam Contact

EDGE RATE
CONTACT



Designed for Signal Integrity
Superior Impedance Control
Reduced Broadside Coupling

MICRO-HYPERBOLOID



High-reliability
Four Points of Contact
Extreme Mating Cycles

INDUSTRY STANDARDS

PRODUCT SUPPORT & EXPERTISE

Samtec provides products that interact with many types of hardware and software. This drives our need to adhere to a variety of Industry Standards. The majority of Industry Standards we engage with address the following:

- Interconnection (cables & connectors)
- Sub-systems (typically daughter or carrier cards, which include functional compliance specifications defining electro-mechanicals and mechanicals)
- Transmission protocols (primarily software and firmware defining machine language to allow communication)
- Hardware (physical electro-mechanical devices)

Visit samtec.com/standards to learn more or contact standards@samtec.com to discuss your application.

STANDARD	PRODUCT	SERIES	PAGE
VITA 42 XMC	SamArray®	YFS/YFT, JSOM	Contact Samtec.
VITA 57.1 FMC	SEARRAY™	SEAM/SEAF, JSOM	25
VITA 57.4 FMC+	SEARRAY™	SEAM/SEAF, JSOM	25
VITA 74 VNX	SEARRAY™	SEAM/SEAF, JSOM	25
VITA 88 XMC+	SEARRAY™	SEAM/SEAF, JSOM	25
VITA 90 VNX+	SEARRAY™	SEAM/SEAF-RA	25-26
COM-HPC®	AcceleRate® HP	APM6/APF6	19
PCI/104-EXPRESS™ & PCI/104-EXPRESS™ ONEBANK	Q2™	QMS/QFS	40
COAXPRESS®	High-Density BNC/FireFly™	HDBNC-TH, HDBNC-BH, HDBNC-EM, ECUO-B04	131, 178
QSFP	QSFP	FQSFP/QSFPC	99
USB/USBR	USB/AccliMate™	USB/USBR/MUSB/MUSBS/SPM, BCU/BPCU/BRU/RCU/RPCU/RPBU/SCPU/SCRUS/SCRU	216-218, samtec.com/usb
COMPUTE EXPRESS LINK™ (CXL™)	Edge Rate®	HSEC6	65

For more industry standards and products that meet them, visit samtec.com/standards.

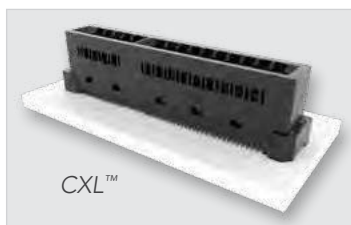
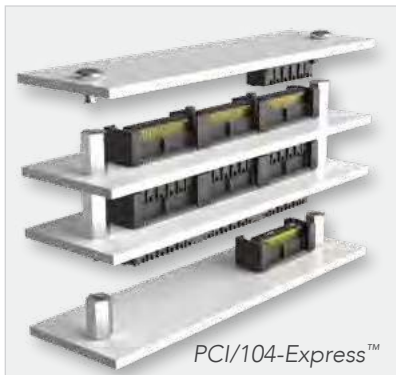

V42 XMC

Rugged Mezzanine System for High-Performance VPX Card Cages

- 3.125 Gbps performance rating
- 10 mm & 12 mm stack heights
- 96 total pins (6 x 16 configuration) with multiple points of contact
- Drop-in ready JSOM ejector jackscrews and mating high-density array cable assemblies available
- SOSA™ aligned connectors

V57.1 FMC

Leading VPX Mezzanine System for Advanced FPGA Integration

- FPGA Industry Standard connector for development applications
- 10 Gbps performance
- HPC & LPC versions (400 & 160 selectively loaded pins)
- 8.5 mm & 10 mm stack heights
- Many high-speed cable & loopback card options available
- Optional JSOM ejector jackscrews available
- SOSA™ aligned connectors

V57.4 FMC+

Advanced State-of-the-Art FPGA Mezzanine Integration

- HSPC Main Connector has 560 pins (14 x 40 configuration), 24 multi-gigabit interfaces, up to 28 Gbps
- HSPCe Extension Connector has 80 pins (4 x 20 configuration) adding 8 multi-gigabit interfaces, 32 in total
- 8.5 mm, 10 mm and 15.5 mm stack heights
- SOSA™ aligned connectors

V57.5 FMC+

Development Tools Aid with FMC+ Applications

- Board connectors for increased stack heights to 15.5 mm
- Standoffs, loopback cards and connector extender cards
- User friendly JSOM ejector jackscrews and mating high-density array cable assemblies available

V90 VNX+

VNX+ Small Form Factor Modules

- Rugged, high-performance, scalable, low power consumption embedded controllers
- 200, 240, 320 & 400 pin connector choices (Right-angle SEARAY™)
- Optimized pinout for improved SI performance and density
- VITA 90.2: Expanded optical and coaxial connectivity provides routing flexibility (FireFly™ and GPCC 50/75 Ω contacts)
- VITA 90.3: Specialized pinout for PSU and filter modules
- 12.5 mm & 19 mm stack heights
- Mating high-density array cable assemblies available
- SOSA™ aligned connectors

PCI-SIG®, PCI Express®, and the PCIe® design marks are registered trademarks and/or service marks of PCI-SIG.

V88 XMC+

Improved Mezzanine Connectors for XMC Applications

- Compatible with VITA 42 footprints
- Improved mating/unmating forces
- PCIe® 5.0+ speeds
- SOSA™ aligned connectors

COM-HPC®

Next-Gen Embedded System Design Scalability & Performance

- Supports edge server & robust embedded computing design applications
- System based on Samtec's AcceleRate® HP high-performance arrays
- 5 mm and 10 mm stack heights
- 400 pin count connectors
- Supports interfaces such as PCIe® 5.0 (32 GT/s) & up to 100 Gb Ethernet

PCI/104-Express™ & PCI/104-Express™ OneBank

Rugged, Stackable & Scalable Embedded Computer Applications

- Q2™ connectors with ground planes
- 3-banks have 156 signal pins, OneBank has 52 pins
- 2.5 Gbps performance
- 15.24 mm & 22 mm stack heights
- Mating high-speed, high density cable assemblies available

COAXPRESS®

Industrial/Professional Application High-Speed Imaging Standard

- Coaxial cable combined with high-speed serial data technology
- Up to 12.5 Gbps data rate per cable
- High-Density BNC 75 Ω connectors and components
- Supports 12G-SDI protocol

QSFP

Compact, Hot-Pluggable Transceiver I/O Connector

- Flyover® solution for optimized signal integrity
- Cage and 38-pin connector
- 30 AWG 100 Ω twinax cable
- 4 high-speed Tx pairs, 4 high-speed Rx pairs
- 28 Gbps NRZ/56 Gbps PAM4 performance per channel
- Meets high-speed protocols including 40/200/400 Gb Ethernet, PCIe®, OIF-CEI-28G, SAS and SATA

USB/USBR

Standardized Connection, Communication & Power Supply

- Type A, Type B, Mini, high retention and sealed versions
- IP67/IP68 sealed circular and rectangular cable systems

COMPUTE EXPRESS LINK™ (CXL™)

Open Systems Interconnect Offering Memory-Semantic Access to Data and Devices Via Multiple Network Topologies

- High-speed, low-latency access to memory across the data center
- 0.60 mm pitch Edge Rate® high-speed edge card connectors

EVALUATION & DEVELOPMENT KITS

From concept and prototype to development and production, Samtec-designed Evaluation and Development Kits simplify the design process and reduce time to market. Kits are available for many of our high-performance connector sets, standard high-speed cable assembly, and optical configurations. Custom kits are also available via our "mix-and-match" design approach. Visit samtec.com/kits or contact kitsandboards@samtec.com for a current list of kit availability.

OPTICS/FPGA DEVELOPMENT KITS

Visit samtec.com/kits for more information.



VITA 57.4 FMC+ HSPC Loopback Card
(Extender Card Available)



VITA 57.4 FMC+ HSPC / HSPCe
Loopback Card (Extender Card Available)



VITA 57.1 FMC Extender Card

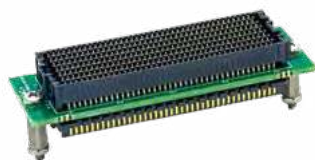

VITA 57.4 FMC+ Extender Card



PCIe®-Over-Fiber
Adaptor Card (PCUO/PCOA)



10 Gbps FireHawk™ Kit



25/28 Gbps FireFly™ FMC+ Kit



14 Gbps FireFly™ FMC Kit



28 Gbps FireFly™ Kit

PRECISION RF EVALUATION KITS

Visit samtec.com/kits for more information.



Bulls Eye® 50 GHz
High-Performance Test System
(BE40A)



Bulls Eye® 70 GHz
High-Performance Test System
(BE70A)

SI EVALUATION KITS: BOARD-TO-BOARD

Visit samtec.com/kits for more information.



Edge Rate® 0.60 mm Pitch High-Speed Edge Card (HSEC6-DV)



Edge Rate® Differential Pair Edge Card (HSEC8-DP)



Edge Rate® 0.635 Pitch High-Speed Strips (ERM6/ERF6)



AccelRate® HP High-Performance Arrays (APM6/APF6)



AccelRate® HD High-Density Arrays (ADM6/ADF6)



NovaRay™ Extreme Density Arrays (NVAM/NVAF)

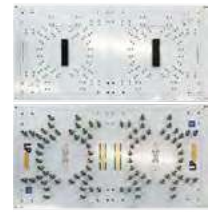

LP Array™ Low Profile Arrays (LPAM/LPAF)



FireFly™ 20+ Gbps Edge Card Socket (UEC5-2)



SEARAY™ High-Density Arrays (SEAM/SEAM-RA & SEAF/SEAF-RA)



ExaMAX® High-Speed Backplane Traditional Connectors (EBTF/EBTM)

SI EVALUATION KITS: CABLE

Visit samtec.com/kits for more information.



AccelRate® Flyover® Slim Cable Assembly (ARC6/ARF6)



Flyover® QSFP28 Cable System (FQSFP to ARC6 and other End 2 options)



Flyover® QSFP Double-Density Cable System (FQSFP-DD to NVAC/ARC6)



NovaRay® Flyover® Extreme Performance Cable Assembly (NVAC/NVAM-C)



Si-Fly™ Low Profile Cable System (CPC/CPI)



ExaMAX® Backplane Cable System (EBCM/EBTF-RA)

HIGH-SPEED CHANNEL PERFORMANCE

CHARACTERIZATION THAT ACCOUNTS FOR THE ENTIRE SIGNAL PATH

Samtec uses a channel-based approach to estimate connector performance in a system. The result is a realistic one number designation for all of Samtec's high-speed interconnects, called **Channel Performance Metric (CPM)**.

This one number designation allows for a side-by-side comparison of Samtec components. Noise contributions from, and interactions with, other parts of a predefined channel are considered. An example of a predefined channel is shown below.

Samtec's CPM reports connector capability that is more representative of actual performance in a system, replacing the connector only data of the past.

This real-world approach factors in all impairments, such as the crosstalk and reflections, inherent in a complete channel. Through Samtec's use of a common set of channel assumptions, relative comparison can then be made across the entire Samtec offering which is practical and realizable. Because Samtec's CPM is a function of necessary channel assumptions made, it is important to note that Samtec's CPM can and will vary from a customer specific application.

Visit samtec.com or contact SIG@samtec.com for technical support prior to final connector selection in any specific application.

Throughout the high-speed sections of this catalog, look for badges indicating Samtec's CPM one number rating for specific product series, for example:

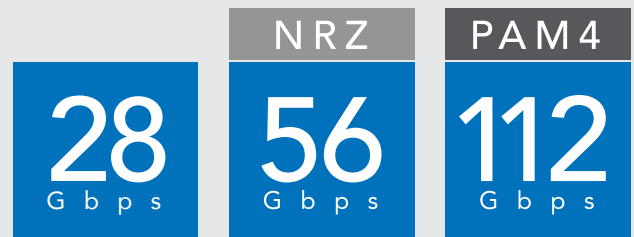

*Note: For speeds of 28 Gbps or less, NRZ encoding scheme is assumed.

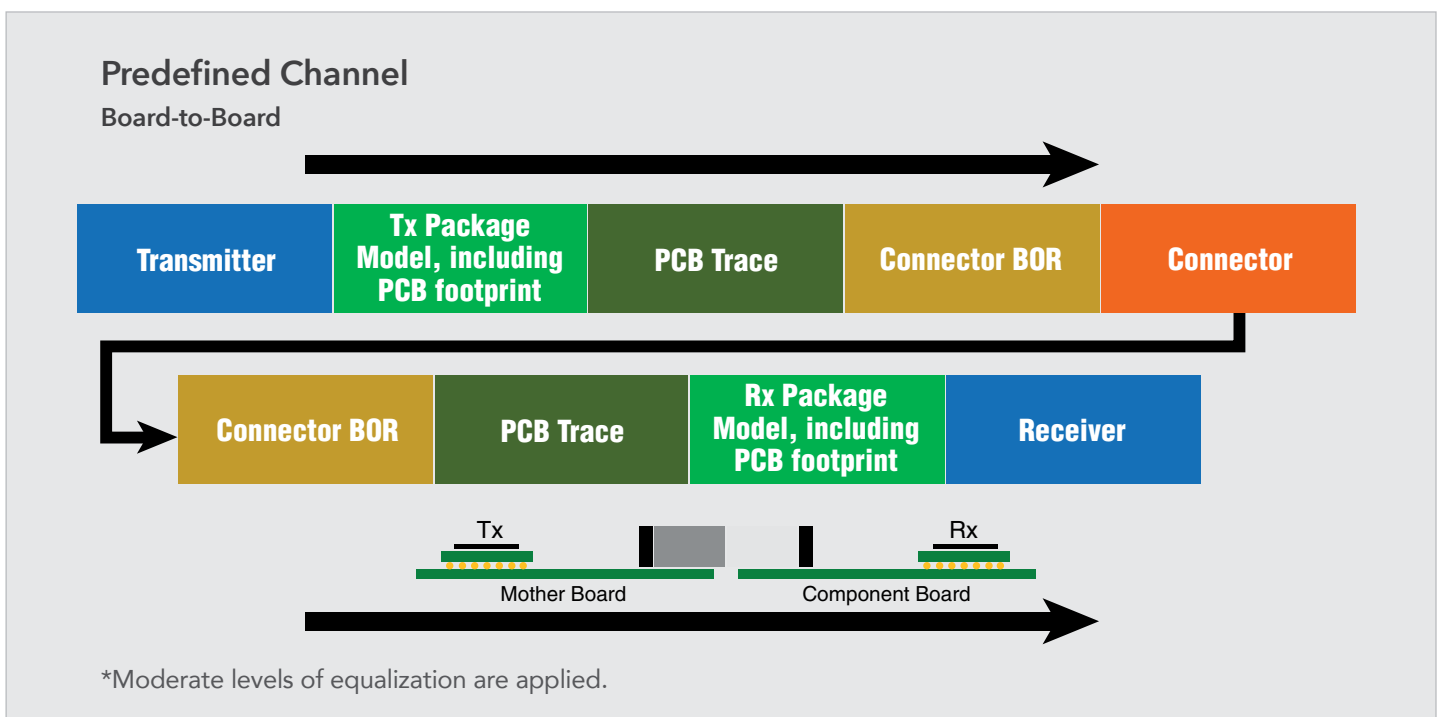

SPECIFICATIONS & TESTING



SPECIFICATIONS & STANDARD TEST PROCEDURES

Samtec products are subject to the following general specifications and standard test procedures.*

QUALITY ASSURANCE

Quality Program Certifications	ISO-9001 and/or IATF 16949
UL File Number	Visit samtec.com/quality
Sampling Procedures	ANSI/ASQ Z1.4
Calibration System Requirements	Per IATF 16949

INSULATOR

Specifications

Molding Plastics, Thermoplastic Polyesters	MIL-M-24519 Rev E
--	-------------------

Applied Tests***

Dielectric Breakdown Voltage	ASTM/ISO
AC Loss Characteristics	ASTM/ISO
Impact Resistance of Plastics	ASTM/ISO
DC Resistance	ASTM/ISO
High-Voltage, Low-Current Arc Resistance	ASTM/ISO
Water Absorption of Plastics	ASTM/ISO
Test for Tensile Properties of Plastics	ASTM/ISO
Deflection Temperature of Plastics	ASTM/ISO
Compressive Properties of Plastics	ASTM/ISO
Coefficient of Linear Thermal Expansion	ASTM/ISO
Shear Strength of Plastics	ASTM/ISO
Rockwell Hardness of Plastics	ASTM/ISO
Flexural Properties of Plastics	ASTM/ISO
Specific Gravity and Density of Plastics	ASTM/ISO

PLATING

Specifications

Gold	ASTM-B488
Tin	ASTM-B545**

Under Plating Specifications

Nickel	QQ-N-290**
Copper	AMS 2418

Applied Tests

Coating thickness (X-Ray Fluorescence)	ASTM-A-754-79
--	---------------

CONTACT & TERMINAL

Specifications***

Brass	ASTM/ISO
Phosphor Bronze	ASTM/ISO
Beryllium Copper	ASTM/ISO

ASSEMBLY

Testing Specifications

Test Methods for Electrical Connectors	EIA-364
Test Methods for Electronic/Electrical Components	EIA-364
Connections, Electrical, Solderless, Wrapped	EIA-364
Environmental Test Methods	EIA-364
Sockets (Lead, Electronic Components), General	EIA-364
Sockets, Plug-in Electronic Components, General	EIA-364

Packaging Specifications

Tape and Reel Packaging of Connectors	Visit samtec.com/packaging
Tray Packaging of Connectors	ANSI/EIA-960
Packaging Materials for ESD Sensitive Items	ANSI/ESD S541
Package Testing Procedures	ISTA-3A

OTHER SPECIFICATIONS

Insulation Resistance	5000 MΩ min
Flammability Rating	UL 94V-0 **** (Typically)

PRODUCT ENVIRONMENTAL COMPLIANCE

Product environmental compliance is a part specific issue for Samtec. To confirm the environmental compliance status of any Samtec product please contact the Product Environmental Compliance Group at PEC@samtec.com and/or visit samtec.com/quality.

Samtec has offered both lead-bearing and lead-free products for many years and will continue to support customers requiring products not compliant with the EU Directives, such as those specified for military, aerospace and specialty applications.

Proposition 65 statement: These products could expose you to chemicals which are known to the State of California to cause birth defects or other reproductive harm. For more information, visit P65Warnings.ca.gov.

LEAD FREE PROCESSING GUIDELINES

Lead-Free Wave Solderable	This product is compatible with wave solder pot temperatures between 260 °C and 270 °C with maximum exposure of the termination pins to the solder wave for 4 seconds.
Lead-Free Reflow Solderable	This product can withstand a maximum peak temperature of 260 °C; 255 °C for up to 30 seconds, and the longer dwell times required for lead-free reflow processing.

AUTOMOTIVE CERTIFICATION (ACD SERIES)

Samtec offers design and manufacture of electronic connectors, marketed as "ACD Series" (Automotive Certified Designs) for printed circuit boards. Samtec shall only comport with ISO/IATF 16949 on products it certifies as Automotive Custom Design ("ACD") or those designated with "A." in the Samtec part number preface of the Automotive Solutions Catalog.

Download the Automotive Solutions catalog at samtec.com/catalog, or contact AutoSalesGroup@samtec.com for qualifying products and alternative automotive application solutions.

Notes:

*Products with specifications other than those listed above are noted on the product's website page.

**With the exception of thickness.

***As dictated by material grade.

****Contact UL@samtec.com for additional flammability ratings.

INDEX BY BRAND NAME

AccelRate™, AccelRate™ HD, AccelRate™ HP, AccelRate™ Mini & AccelRate™ mP

APF6	0.635 mm AccelRate™ HP High-Performance Socket	19
APM6	0.635 mm AccelRate™ HP High-Performance Header	19
ADM6	0.635 mm AccelRate™ HD High-Density Header	21
ADF6	0.635 mm AccelRate™ HD High-Density Socket	21
UDF6	0.635 mm AccelRate™ mP Power/Signal Socket	23
UDM6	0.635 mm AccelRate™ mP Power/Signal Terminal	23
APF6-L	0.635 mm AccelRate™ HP High-Performance Socket	111
ARP6	0.635 mm AccelRate™ HP High-Performance Cable	111
ARC6	0.635 mm AccelRate™ Slim Cable	113
ARF6	0.635 mm AccelRate™ Slim Socket	113
AMF6	0.635 mm AccelRate™ Mini Small Form Factor Cable Socket	115
ARM6	0.635 mm AccelRate™ Mini Small Form Factor Cable	115

AccliMate™

ACX	AccliMate™ IP68 Sealed 12, 16 & 22 mm Assemblies	217
MCX	AccliMate™ IP67 Mini Push-Pull Cable Assemblies	217
BCU/BPCU	AccliMate™ IP67 USB-C Cable Assemblies	218
BRU	AccliMate™ IP67 USB-C Board Mount Socket	218
RPXE	AccliMate™ IP68 Sealed Ethernet Panel Mount Socket & Cable	218
RPXU	AccliMate™ IP68 Sealed USB Panel Mount Socket & Cable	218
SCRXS	AccliMate™ IP68 Sealed Circular USB/Ethernet Socket Cables	218

Edge Rate™

ERF5	0.50 mm Edge Rate™ Rugged High-Speed Socket	47
ERM5	0.50 mm Edge Rate™ Rugged High-Speed Header	47
ERF6	0.635 mm Edge Rate™ Rugged High-Speed Socket	48
ERM6	0.635 mm Edge Rate™ Rugged High-Speed Header	48
ERF8	0.80 mm Edge Rate™ Rugged High-Speed Socket	49, 51, 52
ERM8	0.80 mm Edge Rate™ Rugged High-Speed Header	49, 50, 52
ECDP	0.80 mm Edge Card Twinax Cable Assembly	128
ERCD	0.80 mm Edge Rate™ Coax Cable Assembly	128

ExaMAX™, ExaMAX™ I/O

EBTM	2 mm ExaMAX™ Backplane Header	85
EBDM-RA	2 mm ExaMAX™ Direct Mate Orthogonal Header	86
EBTF-RA	2 mm ExaMAX™ Backplane Socket, Right-Angle	86
EBCF	2 mm ExaMAX™ Backplane Cable Socket	88
EBCM	2 mm ExaMAX™ Backplane Cable Header	88
EBCF/EBTC	2 mm ExaMAX™ I/O Shielded Panel Mount Cable & Cage	105

FireFly™ & Flyover™

FQSF-P-D8	Flyover™ QSFP 800G Double Density Cable System	97
FQSF-DD	Flyover™ QSFP Double Density Cable System	98
FQSF	Flyover™ QSFP Cable System	99
ECUE	FireFly™ 38 AWG Copper Micro Flyover System™	124
PCUE	PCIe-over-FireFly™ Copper Flyover™ Cable	124
ECUO	FireFly™ Optical Micro Flyover System™	131
ETUO	FireFly™ Extended Temp Optical Micro Flyover System™	132
ETMO	FireFly™ Extreme Environment Optical Micro Flyover System™	133
PCUO	PCIe-Over-Fiber FireFly™ Cable	134
PTUO	PCIe-Over-Fiber FireFly™ Extended Temp Cable	134
UCCB	FireFly™ Positive Latching Receptacle	135
UECS	FireFly™ Edge Card Socket	135
PCOA	PCIe-Over-Fiber FireFly™ Adaptor Card	136

FireHawk™

RVCN	FireHawk™ RVCON™ Optical Cables	138
CSP0	FireHawk™ Optical Transceiver for Mil/Aero	139
CSS0	FireHawk™ Optical Transceiver for Space	139

Flex Stack

AW	0.80 mm Flex Stack, Surface Mount Micro Board Stacker	263
MW	1 mm Flex Stack, Surface Mount Micro Board Header	265
FW	1.27 mm Flex Stack, Micro Board Stacker	271
ZML	1.27 mm Flex Stack, Shrouded Elevated Stacker	275
DWM	1.27 mm Flex Stack, Flexible Micro Board Stacker	276
HDWM	1.27 mm Flex Stack, High Temp Micro Board Stacker	276
LTM	2 mm Flex Stack, Shrouded Terminal Strip	284
ZLTM	2 mm Flex Stack, Shrouded Elevated Terminal Strip	284
TW-SM	2 mm Flex Stack, Flexible Board Stacker, SMT	286
HMTSW	2.54 mm Flex Stack, High Temp Modified SQ Post Header	298, 299
MTSW	2.54 mm Flex Stack, Modified SQ Post Header	298, 299
MTLW	2.54 mm Flex Stack, Low Profile .025" SQ Post Header	300
TLW	2.54 mm Flex Stack, Low Profile .025" SQ Post Header	300
HW	2.54 mm Flex Stack, Flexible Board Stacker	301
DW	2.54 mm Flex Stack, Flexible Board Stacker, .110" Tail	302
EW	2.54 mm Flex Stack, Flexible .025" SQ Board Stacker	302
ZW	2.54 mm Flex Stack, Flexible .025" SQ Board Stacker	302
HTSS	2.54 mm High Temp Shrouded Terminal	303
TSS	2.54 mm Flex Stack, Shrouded Header	303
ZSS	2.54 mm Flex Stack, Elevated Shrouded Header	303
HTST	2.54 mm High Temp Shrouded Cable Terminal	317
TST	2.54 mm Flex Stack, Shrouded Cable Header	317
ZST	2.54 mm Flex Stack, Elevated Shrouded Cable Header	317
STMM	2 mm Flex Stack, Shrouded Terminal Cable Strip	321
ZSTMM	2 mm Flex Stack, Shrouded Elevated Cable Header	321

FleXYZ™

TMM-TH	2 mm FleXYZ™ Low Profile Through-Hole Header	280
MTMM	2 mm FleXYZ™ Modified Through-Hole Header	281
TMMH-TH	2 mm FleXYZ™ Flexible Through-Hole Header	283
TW-TH	2 mm FleXYZ™ Flexible Board Stacker, Through-Hole	286
ESQT	2 mm FleXYZ™ Flexible Elevated Socket Strip	288
SQT	2 mm FleXYZ™ Cost-Effective Rugged Socket, Square Tail	289
SOW	2 mm FleXYZ™ Cost-Effective Rugged Socket, Solder Tail	289

FOURRAY™

FOLC	1.27 mm FOURRAY™ High-Density Tiger Eye™ Socket	224
MOLC	1.27 mm FOURRAY™ High-Density High-Reliability Header	224
SOLC	0.635 mm FOURRAY™ Quad Row SMT Socket	267
TOLC	0.635 mm FOURRAY™ Quad Row SMT Terminal	267

Generate™

HSEC6	0.60 mm Generate™ Vertical Card Socket	63
HTEC8	0.80 mm Generate™ Rugged Card Socket	64
HSEC8	0.80 mm Generate™ Card Socket	65, 66, 67, 68
HSEC1	1.00 mm Generate™ Vertical Card Socket	69
GC6	0.60 mm Generate™ Edge Card Cable Assembly	118

LP Array™

LPAF	1.27 mm LP Array™ High-Speed Open-Pin-Field Socket	31
LPAM	1.27 mm LP Array™ High-Speed Open-Pin-Field Terminal	31

Micro Mate™

STSS(T)	1 mm Micro Mate™ Socket Assembly, Single Row	234
SISD(T)	1 mm Micro Mate™ Socket Assembly, Double Row	235
TIPS(T)	1 mm Micro Mate™ Panel Mount Terminal, Single Row	236
TSS(T)	1 mm Micro Mate™ Terminal Assembly, Single Row	236
TIPD(T)	1 mm Micro Mate™ Panel Mount Terminal, Double Row	237
TISD(T)	1 mm Micro Mate™ Terminal Assembly, Double Row	237

Mini Mate™

IPS1	2.54 mm Mini Mate™ Isolated Power Connector Socket	209
IPT1	2.54 mm Mini Mate™ Isolated Power Connector Terminal	209
MMSX(T)	2.54 mm Mini Mate™ Discrete Wire Cable	244
IPL1	2.54 mm Mini Mate™ Shrouded Power Cable Terminal	245

mPOWER™

UMPS	mPOWER™ Ultra Micro Power Socket	193
UMPT	mPOWER™ Ultra Micro Power Terminal	194
UMPC(T)	mPOWER™ Ultra Micro Power Cable-to-Board Assembly, Socket	195
UMPE(T)	mPOWER™ Ultra Micro Power Cable-to-Cable Assembly, Terminal	196
UMPI(T)	mPOWER™ Ultra Micro Power Cable-to-Cable Assembly, Socket	197

NovaRay™, NovaRay™ I/O

NVAF	NovaRay™ Extreme Density & Performance Socket	17
NVAM	NovaRay™ Extreme Density & Performance Terminal	17
NVBF	NovaRay™ Backplane Socket	83
NVBM-RA	NovaRay™ Backplane Right-Angle Terminal	83
NVACP	NovaRay™ I/O Extreme Performance Panel Mount Cable	101
NVACE	NovaRay™ I/O Extreme Performance Cable Assembly	102
NVA3E	NovaRay™ I/O Rugged 38999 Cable Assembly	103
NVA3P	NovaRay™ I/O Rugged 38999 Panel Mount Cable Assembly	103
NVAC	NovaRay™ Extreme Density & Performance Cable Assembly	109
NVAM-CT	NovaRay™ Terminal for NVAC Series	109

PowerStrip™

LPHS	PowerStrip™ EXTreme LPHPower Socket	199
LPHT	PowerStrip™ EXTreme LPHPower Terminal	199
ET60S	PowerStrip™ EXTreme Ten60 Power Socket	201
ET60T	PowerStrip™ EXTreme Ten60 Power Terminal	201
UPPT	3.81 mm PowerStrip™/20 Amp Hermaphroditic Power System	203
UPS	3.81 mm PowerStrip™/20 Amp Dual Leaf Power Socket	203
UPT	3.81 mm PowerStrip™/20 Amp Dual Blade Power Terminal	203
MPS	5 mm PowerStrip™/30 Amp Dual Leaf Socket	204
MPT	5 mm PowerStrip™/30 Amp Dual Blade Terminal	204
MPCS	PowerStrip™/30 Amp Signal/Power Combo Socket	205
MPTC	PowerStrip™/30 Amp Signal/Power Combo Terminal	205
PES/PET	6.35 mm PowerStrip™/40 Amp High Power Socket & Terminal	206
PESC/PETC	PowerStrip™/40 Amp Signal/Power Socket & Terminal	207
MPSS	5 mm PowerStrip™/30 Amp Power Cable Assembly	246
MPCS	PowerStrip™/30 Amp Combo Cable Assembly	247
PESS	6.35 mm PowerStrip™/40 Amp Cable Assembly	248

Power Mate™

IPBS	4.19 mm Power Mate™ Isolated Power Socket	210
IPBT	4.19 mm Power Mate™ Isolated Power Terminal	210
PMSX(T)	4.19 mm Power Mate™ Discrete Wire Power Cable	243

Q Strip™, Q Pairs™

QSH	0.50 mm Q Strip™ High-Speed Ground Plane Socket	37, 44
QTH	0.50 mm Q Strip™ High-Speed Ground Plane Header	37, 44
QSE	0.80 mm Q Strip™ High-Speed Ground Plane Socket	38
QTE	0.80 mm Q Strip™ High-Speed Ground Plane Header	38
QSS	0.635 mm Q Strip™ High-Speed Ground Plane Socket	39, 44
QTS	0.635 mm Q Strip™ High-Speed Ground Plane Header	39, 44
EQCD	0.80 mm Q Strip™ Coax Cable Assembly	128
HQCD	0.50 mm Q Strip™ Coax Cable Assembly	128

Q Rate™

QRF8	0.80 mm Q Rate™ Slim Body Ground Plane Socket	42, 45
QRM8	0.80 mm Q Rate™ Slim Body Ground Plane Header	42, 45
EQRD	0.80 mm Q Rate™ Coax Cable Assembly	128

Q2™

QFS	0.635 mm Q2™ Rugged Ground Plane Socket	40, 45
QMS	0.635 mm Q2™ Rugged Ground Plane Header	40, 45
QFSS	0.635 mm Q2™ Shielded Ground Plane Socket	41
QMSS	0.635 mm Q2™ Shielded Ground Plane Header	41

Razor Beam™

LSHM	0.50 mm Razor Beam™ High-Speed Hermaphroditic Strip	55
LSEM	0.80 mm Razor Beam™ High-Speed Hermaphroditic Strip	56
LSS	0.635 mm Razor Beam™ High-Speed Hermaphroditic Strip	56
HLCD	0.50 mm Razor Beam™ High-Speed Cable Assembly	128

SEARAY™ 0.80 mm

SEAF8	0.80 mm SEARAY™ Ultra-High Density Open-Pin-Field Socket	29
SEAM8	0.80 mm SEARAY™ Ultra-High Density Open-Pin-Field Terminal	29

SEARAY™

SEAF	1.27 mm SEARAY™ High-Density Open-Pin-Field, Socket	25, 26
SEAM	1.27 mm SEARAY™ High-Density Open-Pin-Field, Terminal	25, 26
SEAFP	1.27 mm SEARAY™ Press-Fit High-Density Array, Socket	27
SEAMI	1.27 mm SEARAY™ 85 Ω-tuned High-Density Array, Terminal	27
SEAMP	1.27 mm SEARAY™ Press-Fit High-Density Array, Terminal	27
SEAR	1.27 mm SEARAY™ High-Density Riser, 85 Ω	27
SEAC	1.27 mm SEARAY™ High-Speed/High-Density Jumper	123

Si-Fly™

CPC	Si-Fly™ Low Profile High-Density Copper Cable	117
CPI	Si-Fly™ Low Profile High-Density Interconnect	117

Tiger Beam™

CLE	0.80 mm Tiger Beam™ Cost-Effective Micro Socket	262
MLE	1 mm Tiger Beam™ Cost-Effective Micro Socket	266
FLE	1.27 mm Tiger Beam™ Cost-Effective Reliable Socket	273
TLE	2 mm Tiger Beam™ Cost-Effective Reliable Socket	291
HLE	2.54 mm Tiger Beam™ Cost-Effective Reliable Socket	308

Tiger Buy™

SLM	1.27 mm Tiger Buy™ Low Profile Through-Hole Micro Socket	278
SMS	1.27 mm Tiger Buy™ Through-Hole Micro Socket	278
LS2	2 mm Self-Mating Hermaphroditic Strip	292
SSO	2.54 mm Tiger Buy™ Socket.025" SQ Post	304
SSW	2.54 mm Tiger Buy™ Socket	304, 305
ESQ	2.54 mm PC/104" Elevated Socket	307
ESW	2.54 mm PC/104" Elevated Socket	307
BSW	2.54 mm Bottom Mount Socket Strip	310
SLW	2.54 mm Tiger Buy™ Low Profile Socket Strip	311

Tiger Claw™

CLM	1 mm Tiger Claw™ Rugged Reliable Micro Socket	266
CLP	1.27 mm Tiger Claw™ Low Profile Dual Wipe Socket	272
MMS	2 mm Tiger Claw™ Socket Strip	290
CLT	2 mm Tiger Claw™ Low Profile Dual Wipe Socket	291
SSM	2.54 mm Tiger Claw™ Pass-Through SMT Socket	306
BCS	2.54 mm Tiger Claw™ Pass-Through Through-Hole Socket	309

Tiger Eye™

SFM	1.27 mm Tiger Eye™ High-Reliability Socket	221
SFML	1.27 mm Tiger Eye™ High-Reliability Locking Socket	221
SFC	1.27 mm Tiger Eye™ Cost-Effective Reliable Socket	223
SFMC	1.27 mm Tiger Eye™ Flexible Pin Count Socket	225
SEM	0.80 mm Tiger Eye™ Micro Socket	227
S2M	2 mm Tiger Eye™ Discrete Wire Cable Socket	229
SMM	2 mm Tiger Eye™ High-Reliability Socket	230
SFSX(T)	1.27 mm Tiger Eye™ Discrete Wire Cable	238, 239
S2SD(T)	2 mm Tiger Eye™ Discrete Wire Socket Cable	240
SESdT	0.80 mm Tiger Eye™ Discrete Wire Socket Cable	241
TCXD	2 mm Tiger Eye™ IDC High-Reliability Cables	318, 319
FFXD	1.27 mm Tiger Eye™ IDC Ribbon Cable Assemblies	322, 323
FTXP	1.27 mm Tiger Eye™ IDC Twisted Pair Cables	325

URSA™ I/O

B1SD(T)	URSA™ I/O Ultra Rugged Socket Cable Assembly	213
P1PD(T)	URSA™ I/O Ultra Rugged Panel Mount Terminal Cable	214
P1M	URSA™ I/O Ultra Rugged Board Mount I/O Connector	215

XCede™ HD

HDTM	1.80 mm XCede™ HD Vertical Backplane Header	91
HDTF	1.80 mm XCede™ HD Right-Angle Backplane Receptacle	92

Series	Description	Page	Series	Description	Page
135	50 Ω Precision 1.35 mm Compression Jacks	149	RF047	50 Ω Flexible RF Cable Assembly, (.047" DIA) 28 AWG	181
185	50 Ω Precision 1.85 mm Compression Jacks	150	RF047-A	50 Ω .047" Overshield DIA, 29 AWG mmWave Cable	148-152, 154-155, 158
240	50 Ω Precision 2.40 mm Compression Jacks	151	RF058	50 Ω RF Cable Assembly, RG 58 Cable	170, 173
292	50 Ω Precision 2.92 mm Compression Jacks	152	RF085	50 Ω .085" Overshield DIA 24 AWG mmWave Cable	151, 152
BE90A	90 GHz Bulls Eye® Assembly, Single or Double Row	165	RF086	50 Ω .086" Overshield DIA 23 AWG mmWave Cable	150-152, 154-155, 158
BE70A	70 GHz Bulls Eye® Assembly, Single or Double Row	166	RF23C	50 Ω mmWave Cable, 23 AWG, Copper Shield	151-152, 154-155, 158
BE40A	50 GHz & 40 GHz Bulls Eye® Assembly, Double Row	166	RF23S	50 Ω μWave Cable, 23 AWG Solid FEP Dielectric	153
BNC5-CA	50 Ω BNC Cable Connectors	174	RF25S	50 Ω μWave Cable, 25 AWG Solid FEP Dielectric	154, 158
BNC7T	75 Ω 12G-SDI BNC Jacks	177	RF174	50 Ω RF Cable Assembly, RG 174 Cable	170-175
BNC7T-CA	75 Ω 12G-SDI BNC Cable Connectors	176	RF178	50 Ω RF Cable Assembly, RG 178 Cable	170-175
C28S	100 Ω Shielded Twisted Pair Twinax Cable Assembly	181	RF179	75 Ω RF Cable Assembly, RG 179 Cable	176, 179-180
CJT	100 Ω Twinax Jacks	181	RF180	50 Ω .178" Overshield DIA, 16 AWG μWave Cable	154, 160-161
DIN7A	75 Ω, 12G-SDI DIN 1.0/2.3 Jacks	179	RF280	50 Ω .277" Overshield DIA, 11 AWG μWave Cable	154, 160-161
DIN7A-CA	75 Ω, 12G-SDI DIN 1.0/2.3 Cable Connectors	179	RF316	50 Ω RF Cable Assembly, RG 316 Cable	170-175
GC47	50 Ω Precision Ganged SMPM Assembly, .047" Cable	156	RF402	50 Ω RG 402 19 AWG Semi-flexible μWave Cable	154
GC86	50 Ω Precision Ganged SMPM Assembly, .086" Cable	156	RF405	50 Ω RG 405 24 AWG Semi-flexible μWave Cable	154, 158
GPPB	50 Ω Precision Ganged SMPM Block, Board-to-Board	157	RFA6T	75 Ω RF Cable Assembly, RG 6 Cable	176, 178-179
GPPC	50 Ω Ganged SMPM Cable Board Mates	156, 157	RFB6T	75 Ω RF Cable Assembly, 1694A Cable	176, 178-179
GRF1-C	5.00 mm 50 Ω Ganged Micro-Mini RF Plugs, Cable	181	RFB8T	75 Ω RF Cable Assembly, 1855A Cable	178-179
GRF1H-C	5.00 mm 50 Ω Ganged Hybrid Micro-Mini RF Cable	181	RFC6T	75 Ω RF Cable Assembly, Belden 4694R Cable	176, 178-179
GRF1-J	5.00 mm 50 Ω Ganged Micro-Mini RF Jacks, PCB Mount	181	RFC8T	75 Ω RF Cable Assembly, Belden 4855R Cable	178-179
GRF1-P	5.00 mm 50 Ω Ganged Micro-Mini RF Plugs, PCB Mount	181	RS316	50 Ω RF Cable Assembly, Double-Shielded RG 316 Cable	170-174
GRF7-C	5.00 mm 75 Ω Ganged Micro-Mini RF Plugs, Cable	181	SMB5	50 Ω SMB Jacks	175
GRF7H-C	5.00 mm 75 Ω Ganged Hybrid Micro-Mini RF Cable	181	SMB5-CA	50 Ω SMB Cable Connectors	175
GRF7-P	5.00 mm 75 Ω Ganged Micro-Mini RF Plugs, PCB Mount	181	SMB7H	75 Ω SMB Jacks	180
GRF7-J	5.00 mm 75 Ω Ganged Micro-Mini RF Jacks, PCB Mount	181	SMB7H-CA	75 Ω SMB Cable Connectors	180
HDBNC	75 Ω, 12G-SDI High-Density BNC Jacks	178	SMA	50 Ω Precision SMA Jacks	154
HDBNC-CA	75 Ω, 12G-SDI High-Density Cable Connectors	178	SMA-CA	50 Ω SMA Low Frequency Cable Connectors	170
IJ5	4.00 mm IsoRate® 50 Ω High Isolation RF Jack Strip	181	SMP	50 Ω Precision SMP Plugs & Bullet Adaptors	159
IJ5C	4.00 mm IsoRate® 50 Ω High Isolation RF Cable	181	SMPM	50 Ω Precision SMPM Plugs	155
IJ5H	4.00 mm IsoRate® 50 Ω High Isolation Hybrid Cable	181	TNC	50 Ω TNC Jacks	173
IP5	4.00 mm IsoRate® 50 Ω High Isolation RF Plug Strip	181	TNC-CA	50 Ω TNC Cable Connectors	173
MCX	50 Ω MCX Jacks & Plugs	171	WF12	E-Band Flexible Waveguide Assembly	167
MCX7	75 Ω MCX Jacks & Plugs	181	WF15	V-Band Flexible Waveguide Assembly	167
MCX7-CA	75 Ω MCX Cable Connectors	181	WGBA	Between-Series Waveguide Flange Adaptor	167
MCX-CA	50 Ω MCX Cable Connectors	171			
MMCX	50 Ω MMCX Jacks & Plugs	172			
MMCX-CA	50 Ω MMCX Cable Connectors	172			
MMCX7	75 Ω MMCX Jacks & Plugs	181			
MMCXV	50 Ω MMCX High-Vibration Jacks & Plugs	181			
MMCXV-CA	50 Ω MMCX High-Vibration Cable Connectors	181			
MH081	50 Ω Micro High Frequency RF Cable, 0.81 mm DIA	169			
MH113	50 Ω Micro High Frequency RF Cable, 1.13 mm DIA	169			
PRF00	Precision SMP Cable Connectors, 40 GHz	158			
PRF01	Precision SMA Cable Connectors, 26.5 GHz	154			
PRF04	Precision TNCA Cable Connectors, 18 GHz	161			
PRF06	Precision N Type Cable Connectors, 18 GHz	160			
PRF10	Precision 1.00 mm Cable Connectors, 110 GHz	148			
PRF13	Precision 1.35 mm Cable Connectors, 90 GHz	149			
PRF18	Precision 1.85 mm Cable Connectors, 65 GHz	150			
PRF24	Precision 2.40 mm Cable Connectors, 50 GHz	151			
PRF92	Precision 2.92 mm Cable Connectors, 40 GHz	152			
PRF35	Precision 3.50 mm Cable Connectors, 34 GHz	153			
PRFIA	Precision 50 Ω In-Series Bullet Adaptors	162			
PRFBA	Precision 50 Ω Between-Series Bullet Adaptors	163			
PRFMO	Precision SMPM Cable Connectors, 65 GHz	155			
PRFS1	Precision SSMA Cable Connectors, 34 GHz	153			



INDEX BY SERIES

Series	Description	Page	Series	Description	Page	Series	Description	Page
ACD	Automotive Certified Design	333	ERC	0.80 mm Eye Speed [®] I/O Cage for ER18-RA	**	HQDP	0.50 mm Q Pairs [™] Twinax Cable Assembly	128
ACP-12	AccliMate [™] IP68 Sealed 12 mm Cable Assembly	217	ERCD	0.80 mm Edge Rate [™] Coax Cable Assembly	128	HSC8	0.80 mm High-Speed Riser Card	**
ACP-16	AccliMate [™] IP68 Sealed 16 mm Cable Assembly	217	ERDP	0.80 mm Edge Rate [™] Twinax Cable Assembly	128	HSEC1-DV	1 mm Generate [™] Vertical Card Socket	69
ACP-22	AccliMate [™] IP68 Sealed 22 mm Cable Assembly	217	ERF5	0.50 mm Edge Rate [™] Rugged High-Speed Socket	47	HSEC6-DV	0.60 mm Generate [™] Vertical Card Socket	63
ACR-12	AccliMate [™] IP68 Sealed 12 mm Panel Assembly	217	ERF6	0.635 mm Edge Rate [™] Rugged High-Speed Socket	48	HSEC8-DP	0.80 mm Generate [™] Differential Pair Card Socket	68
ACR-16	AccliMate [™] IP68 Sealed 16 mm Panel Assembly	217	ERF8	0.80 mm Edge Rate [™] Rugged High-Speed Socket	49	HSEC8-DV	0.80 mm Generate [™] Vertical Card Socket	65
ACR-22	AccliMate [™] IP68 Sealed 22 mm Panel Assembly	217	ERF8-EM	0.80 mm Edge Rate [™] Rugged Edge Mount Socket	51	HSEC8-EM	0.80 mm Generate [™] Edge Mount Card Socket	66
ADM5	0.635 mm AcceleRate [™] HD High-Density Socket	21	ERF8-RA	0.80 mm Edge Rate [™] Rugged Right-Angle Socket	51	HSEC8-PE	0.80 mm Generate [™] Pass-Through Card Socket	67
ADM6	0.635 mm AcceleRate [™] HD High-Density Header	21	ER18-RA	0.80 mm Eye Speed [®] I/O Right-Angle Edge Rate [™] Socket	**	HSEC8-PV	0.80 mm Generate [™] Power/Signal Combo Socket	67
AMF6	AcceleRate [™] Mini Small Form Factor Cable Socket	115	ERM5	0.50 mm Edge Rate [™] Rugged High-Speed Header	47	HSEC8-RA	0.80 mm Generate [™] Right-Angle Card Socket	66
APF6	0.635 mm AcceleRate [™] HP High-Performance Socket	19	ERM6	0.635 mm Edge Rate [™] Rugged High-Speed Header	48	HS-QSFP	Heat Sink for QSFP	99
APF6-L	0.635 mm AcceleRate [™] HP Cable Assembly Socket	111	ERM8	0.80 mm Edge Rate [™] Rugged High-Speed Header	49	HS-QSFP-D8	Heat Sink for QSFP-D8	97
APM6	0.635 mm AcceleRate [™] HP High-Performance Header	19	ERM8-EM	0.80 mm Edge Rate [™] Rugged Edge Mount Header	50	HS-QSFP-DD	Heat Sink for QSFP-DD	98
ARC6	0.635 mm AcceleRate [™] Slim Cable	113	ER18-RA	0.80 mm Edge Rate [™] Rugged Right-Angle Header	50	HSS	2.54 mm High Temp Single Row Machined Socket	**
ARF6	0.635 mm AcceleRate [™] Slim Socket	113	ESCA	0.80 mm SEARAY [™] High-Speed Cable Assembly	123	HTEC8	0.80 mm Generate [™] Rugged Card Socket	64
ARM6	AcceleRate [™] Mini Small Form Factor Cable	115	ESD	2.54 mm Elevated Double Row Screw Machined Socket	**	HTMS	1.27 mm High Temp Through-Hole Micro Terminal	274
ARP6	0.635 mm AcceleRate [™] HP High-Performance Cable	111	ESHF	1.27 mm Shrouded IDC Header	324	HTS	2.54 mm High Temp Single Row Machined Terminal	**
ASP	Application Specific Product	14	ESQ	2.54 mm PC/104 [™] Elevated Socket	307	HTSS	2.54 mm High Temp Shrouded Terminal	303
AW	0.80 mm Flex Stack, Surface Mount Micro Board Stacker	263	ESQT	2 mm FlexYZ [™] Flexible Elevated Socket Strip	288	HTST	2.54 mm High Temp Shrouded Cable Terminal	317
B1SD(T)	URSA [™] I/O Ultra Rugged Socket Cable Assembly	213	ESQT-368	2 mm PC/104-Plus [™] Self-Nesting Socket	288	HTSW	2.54 mm High Temp Terminal	294
B1SDS	URSA [™] I/O Metal Shell for Cable Socket Housing	213	ESS	2.54 mm Elevated Single Row Screw Machined Socket	**	HW-SM	2.54 mm Flex Stack, Board Stacker, Surface Mount	301
BBD	2.54 mm Double Row, Machined Terminal Strip	**	ESW	2.54 mm PC/104 [™] Elevated Socket	307	HWTH	2.54 mm Flex Stack, Board Stacker, Through-Hole	301
BBL	2.54 mm Low Profile Single Row, Machined Terminal Strip	**	ET60S	2.54 mm PowerStrip [™] EXtreme Ten60Power [™] Socket	201	IBT1	URSA [™] I/O Ultra Rugged Cable Socket Housing	213
BBS	2.54 mm Single Row, Machined Terminal Strip	**	ET60T	2.54 mm PowerStrip [™] EXtreme Ten60Power [™] Terminal	201	IDMX	2.54 mm Slim IDC Ribbon Cable, Terminal	314
BGS	2.54 mm Tiger Claw [™] Pass-through Through-Hole Socket	309	ETMT	2 mm Shrouded Strain Relief IDC Header	320	IDP1	1 mm Micro Mate [™] Double Row Panel Mount Housing	237
BCU	AccliMate [™] IP67 Sealed USB-C Cable Plug	218	ETMO	FireFly [™] Extreme Environment Optical System	133	IDXS	2.54 mm Slim IDC Ribbon Cable, Socket	314
BDL	2.54 mm Low Profile Double Row, Machined Terminal Strip	**	ETUO	FireFly [™] Extended Temp Optical Micro Flyover System [™]	132	IDT1	1 mm Micro Mate [™] Double Row Terminal Housing	237
BHS	2.54 mm High Temp Single Row, Machined Terminal Strip	**	EW	2.54 mm Flex Stack, Flexible, 025" SQ Board Stacker	302	IMPC	mPOWER [™] Discrete Wire Socket Housing	195
BKS	1 mm Polarized Micro Socket	**	FC1	1 mm Flat Flexible Cable (FFC) Socket	326	IMPE	mPOWER [™] Discrete Wire Terminal Housing	196
BKT	1 mm Polarized Micro Terminal	**	FCDP	0.50 mm High-Speed Edge Card Socket for F FDP	128	IMSS	PowerStrip [™] /30 Amp Discrete Wire Socket Housing	246
BPCU	AccliMate [™] IP67 Sealed USB-C Cable Receptacle	218	FDDP	0.50 mm High-Speed Edge Card Cable Assembly	128	IMSC5	PowerStrip [™] /30 Amp Discrete Wire Combo Housing	247
BRU	AccliMate [™] IP67 Sealed USB-C Board Mount Receptacle	218	FCF8	0.80 mm High-Speed Cost-Effective Coax Cable Assembly	128	IPBD	4.19 mm Power Mate [™] Discrete Wire Socket Housing	243
BSE	0.80 mm Basic Blade & Beam Socket	261	FCS8	0.80 mm High-Speed Cost-Effective Coax Cable Socket	128	IPBS	4.19 mm Power Mate [™] Isolated Power Socket	210
BSH	0.50 mm Basic Blade & Beam Socket	259	FFMD	1.27 mm Tiger Eye [™] IDC Ribbon Cable Assembly, Male	323	IPBT	4.19 mm Power Mate [™] Isolated Power Terminal	210
BSS	0.635 mm Basic Blade & Beam Socket	260	FFSD	1.27 mm Tiger Eye [™] IDC Ribbon Cable Assembly, Female	322	IPD1	2.54 mm Mini Mate [™] Discrete Wire Socket Housing	244
BSW	2.54 mm Bottom Mount Socket Strip	310	FFTP	1.27 mm Tiger Eye [™] IDC Twisted Pair Cable, Female	325	IPL1	2.54 mm Mini Mate [™] Shrouded Power Cable Terminal	245
BTE	0.80 mm Basic Blade & Beam Header	261	FHP	3.96 mm Power Eye Socket	**	IPP1	URSA [™] I/O Ultra Rugged Cable Terminal Housing	214
BTH	0.50 mm Basic Blade & Beam Header	258	FJ	1 mm Flat Flexible Cable (FFC) Jumper	326	IPS1	2.54 mm Mini Mate [™] Isolated Power Connector Socket	209
BTS	0.635 mm Basic Blade & Beam Header	260	EJH	0.50 mm Flat Flexible Cable (FFC) Jumper	326	IPS6	PowerStrip [™] /40 Amp Discrete Wire Socket Housing	248
CC03	Tiger Eye [™] Contact for ISDF	238	FLE	1.27 mm Tiger Beam [™] Cost-Effective Reliable Socket	273	IPT1	2.54 mm Mini Mate [™] Isolated Power Connector Terminal	209
CC09	Micro Mate [™] Contact for ISS1/ISD1	234	FMP5	5 mm PowerStrip [™] /30 Amp "Hinging" Power Socket	**	ISD1	1 mm Micro Mate [™] Double Row Socket Housing	235
CC10	PowerStrip [™] Contact for IPS6	248	FMP7	5 mm PowerStrip [™] /30 Amp "Hinging" Power Header	**	ISD2	2 mm Tiger Eye [™] Discrete Wire Socket Housing	240
CC396	Tiger Eye [™] Contact for ISDE	241	FMP8	1.27 mm Tiger Eye [™] IDC Twisted Pair Cable, Male	325	ISDE	0.80 mm Tiger Eye [™] Discrete Wire Socket Housing	241
CC46	PowerStrip [™] Contact for IMSS and IMSC5	246	FOLC	1.27 mm FOURRAY [™] High-Density Tiger Eye [™] Socket	224	ISDF	1.27 mm Tiger Eye [™] Discrete Wire Socket Housing	238
CC489	mPOWER [™] Crimp Contact	195	FOPC	Fiber Optic Patch Cable	137	ISP1	1 mm Micro Mate [™] Single Row Panel Mount Housing	236
CC508	URSA [™] I/O Crimp Contact	213	FQFPP	Flyover [™] QSFP Cable System	99	ISS1	1 mm Micro Mate [™] Single Row Socket Housing	234
CC69	Power Mate [™] Contact for IPBD	243	FQSF-D8	Flyover [™] QSFP 800G Double Density Cable System	97	IST1	1 mm Micro Mate [™] Single Row Terminal Housing	236
CC79	Mini Mate [™] Contact for IPD1	244	FQSF-DD	Flyover [™] QSFP Double Density Cable System	98	JL	2.54 mm Jumper Link	312
CC81	Tiger Eye [™] Contact for ISD2 and IMSC5	240	FSS	0.50 mm High-Speed Floating Contact Socket	257	JSO	Jack Screw Precision Board Stacking Standoff	33
CES	2.54 mm Closed Entry Low Profile Socket Strip	311	FSI	1 mm One-Piece Interface	254	JSOM	Micro Jack Screw Precision Board Stacking Standoff	**
CLE	0.80 mm Tiger Beam [™] Cost-Effective Micro Socket	262	FT5	0.50 mm High-Speed Floating Contact Terminal	257	JW	3.96 mm Flex Stack, Power Board Stacker	**
CLM	1 mm Tiger Claw [™] Rugged Reliable Micro Socket	266	FTE	0.80 mm SMT Micro Header	262	LPAF	1.27 mm LP Array [™] High-Speed Open-Pin-Field Array	31
CLP	1.27 mm Low Profile Dual Wipe Socket	272	FTM	1 mm SMT Micro Low Profile Terminal Strip	264	LPAM	1.27 mm LP Array [™] High-Speed Open-Pin-Field Array	31
CLT	2 mm Low Profile Dual Wipe Socket	291	FTH	1.27 mm SMT Micro Terminal Strip	270	LPHS	PowerStrip [™] EXtreme LPHPower [™] Socket	199
CPC	Si-Fly [™] Low Profile High-Density Copper Cable	117	FIS	1.27 mm Micro Low Profile Terminal Strip	277	LPHT	PowerStrip [™] EXtreme LPHPower [™] Terminal	199
CPI	Si-Fly [™] Low Profile High-Density Interconnect	117	FTSH-SM	1.27 mm SMT Micro Terminal Strip	268	LP-FOSFP	Light Pipe for QSFP and HS-QSFP	99
CPSO	FireHawk [™] Optical Transceiver for Mil/Aero	139	FTSH-TH	1.27 mm Through-Hole Micro Terminal Strip	269	LS2	2 mm Self-Mating Hermaphroditic Strip	292
CSSO	FireHawk [™] Optical Transceiver for Space	139	FWJ	3.96 mm Power Terminal Strip	**	LSEM	0.80 mm Razor Beam [™] High-Speed Hermaphroditic Strip	56
DW	2.54 mm Flex Stack, Flexible Board Stacker, .110" Tail	302	FW-SM	1.27 mm Flex Stack, SMT Micro Board Stacker	271	LSH	0.50 mm Low Profile Blade & Beam Socket	256
DWM	1.27 mm Flex Stack, Flexible Micro Board Stacker	276	FWTH	1.27 mm Flex Stack, Through-Hole Micro Board Stacker	271	LSHM-DH	0.50 mm Razor Beam [™] Right-Angle Hermaphroditic Strip	55
EBCB	ExaMAX [™] Panel Retention Bracket	89	GC6	0.60 mm Generate [™] Edge Card Cable Assembly	118	LSHM-DV	0.50 mm Razor Beam [™] High-Speed Hermaphroditic Strip	55
EBCE	2 mm ExaMAX [™] I/O Shielded Panel Mount Cable	105	GC6-RF	Generate [™] High-Speed Test Cable	127	LSHM-RH	0.50 mm Razor Beam [™] Reversed - RA Hermaphroditic Strip	55
EBCF	2 mm ExaMAX [™] Backplane Cable Socket	88	GMI	SUPERNOVA [™] Low Profile One-Piece Compression Interposer	34	LSS	0.635 mm Razor Beam [™] High-Speed Hermaphroditic Strip	56
EBCL	ExaMAX [™] Vertical Latching Shroud	89	GP50	SureWare [™] Ultra Rugged Guide Post Standoffs	34	LTH	0.50 mm Low Profile Blade & Beam Terminal	256
EBCM	2 mm ExaMAX [™] Backplane Cable Header	88	HALO	Halo [™] Next Gen Optical Assembly	139	LTM	2 mm Shrouded Terminal Strip	284
EBDM-RA	2 mm ExaMAX [™] Direct Mate Orthogonal Header	86	HCMX	2.54 mm IDC Assembly, Terminal	**	MCP	AccliMate [™] IP67 Mini Push-Pull Cable Assembly	217
EBTC	ExaMAX [™] I/O Shielded Right-Angle Cage for EBDM-RA	105	HCSX	2.54 mm IDC Assembly, Socket	**	MCR	AccliMate [™] IP67 Mini Push-Pull Panel Assembly	217
EBTF-RA	2 mm ExaMAX [™] Backplane Socket, Right-Angle	86	HDC	Eye Speed [®] HD Cage for HDLSP/HD16	**	MEC1-DV	1 mm Mini Edge Card Socket, Vertical	75
EBTM	2 mm ExaMAX [™] Backplane Header	85	HD16	0.635 mm Eye Speed [®] HD Socket for HDLSP	**	MEC1-EM	1 mm Mini Edge Card Socket, Edge Mount	76
EC2	2 mm Shrouded IDC Ejector Header Cap	320	HDLSP	0.635 mm Eye Speed [®] HD High-Speed I/O Cable System	**	MEC1-RA	1 mm Mini Edge Card Socket, Right-Angle	76
ECDP	0.80 mm Twinax Edge Card Cable Assembly	128	HDWM	1.27 mm Flex Stack, High Temp Micro Board Stacker	276	MEC2-DV	2 mm Mini Edge Card Socket, Vertical Surface Mount	77
ECUE	FireFly [™] Copper Micro Flyover System [™]	124	HDIF	1.80 mm XCede [™] HD Right-Angle Backplane Receptacle	92	MEC2-TH	2 mm Mini Edge Card Socket, Vertical Through-Hole	77
ECUO	FireFly [™] Optical Micro Flyover System [™]	131	HDIM	1.80 mm XCede [™] HD Vertical Backplane Header	91	MEC5-DV	0.50 mm Micro Edge Card Socket, Vertical	71
EGBF	ExaMAX [™] Socket Guide Module	87	HFJW	3.96 mm High Temp Power Header	**	MEC5-RA	0.50 mm Micro Edge Card Socket, Right-Angle	71
EGBM	ExaMAX [™] Terminal Guide Module	87	HLCD	0.50 mm Razor Beam [™] High-Speed Cable Assembly	128	MEC6-DV	0.635 mm Micro Edge Card Socket, Vertical	72
EHF	1.27 mm Shrouded IDC Ejector Header	324	HLE	2.54 mm Tiger Beam [™] Cost-Effective Reliable Socket	308	MEC6-RA	0.635 mm Micro Edge Card Socket, Right-Angle	72
EHT	2 mm Shrouded IDC Ejector Header	320	HMTMS	1.27 mm Flex Stack, High Temp Modified Micro Header	**	MEC8-DV	0.80 mm Micro Edge Card Socket, Vertical	73
EJH	2.54 mm Shrouded IDC Ejector Header	316	HMTSW	2.54 mm Flex Stack, High Temp Modified SQ Post Header	298	MEC8-RA	0.80 mm Micro Edge Card Socket, Right-Angle	74
EPLSP	0.80 mm Eye Speed [®] I/O Rugged Latching Cable System	**	HPF	5.08 mm Power Socket	**	MEC8-EM	0.80 mm Micro Edge Card Socket, Edge Mount	74
EPTS	ExaMAX [™] Socket Power Module	87	HPM	5.08 mm Power Header	**	MEC8-VP	0.80 mm Micro Edge Card Socket, Press-Fit	73
EPTT	ExaMAX [™] Terminal Power Module	87	HPTS	XCede [™] HD Power Module Socket	92	MECF	1.27 mm Mini Edge Card Socket, Vertical	77
EQCD	0.80 mm Q Strip [™] Coax Cable Assembly	128	HPTT	XCede [™] HD Power Module Terminal	92	MECT	0.80 mm SFP+ Edge Card Connector	**
EQDP	0.80 mm Q Pairs [™] Twinax Cable Assembly	128	HPW	5.08 mm Power Board Stacker	128	MILE	1 mm Tiger Beam [™] Cost-Effective Micro Socket	266
EQRD	0.80 mm Q Rate [™] Coax Cable Assembly	**	HQCD	0.50 mm Q Strip [™] Coax Cable Assembly	128			

INDEX BY SERIES

Series	Description	Page	Series	Description	Page	Series	Description	Page
MMS	2 mm Tiger Claw™ Socket Strip	290	OTH-RA	0.50 mm Q.Strip™ High-Speed Header, Right-Angle	44	SSW-SM	2.54 mm Tiger Buy™ SMT Socket	305
MMSD(T)	2.54 mm Mini Mate™ Discrete Wire Cable, Double Row	244	QTS	0.635 mm Q.Strip™ High-Speed Ground Plane Header	39	ST4	0.40 mm Micro Blade & Beam Ultra Fine Pitch Header	57
MMS(T)	2.54 mm Mini Mate™ Discrete Wire Cable, Single Row	244	QTS-RA	0.635 mm Q.Strip™ Ground Plane Header, Right-Angle	54	ST5	0.50 mm Micro Blade & Beam Low Profile Header	58
MMT	2 mm Horizontal Surface Mount Terminal	281	RPBE	AccliMate™ IP68 Sealed Ethernet Panel Mount Socket	218	STMM	2 mm Flex Stack, Shrouded Terminal Cable Strip	321
MNT	2.54 mm Multi-Position Shunt	312	RPBU	AccliMate™ IP68 Sealed USB Panel Mount Socket	218	T1M	1 mm Micro Mate™ Discrete Wire Terminal	233
MOLC	1.27 mm FOURRAY™ High-Density High-Reliability Header	224	RPCE	AccliMate™ IP68 Sealed Ethernet Panel Mount Socket Cable	218	T2M	2 mm Tiger Eye™ High-Reliability Discrete Wire Cable Header	229
MPCC	PowerStrip™/30 Amp Power/Signal Combo Assembly	247	RPCU	AccliMate™ IP68 Sealed USB Panel Mount Cable	218	T2SD(T)	2 mm Tiger Eye™ Discrete Wire Terminal Cable	**
MPPT	5 mm PowerStrip™/30 Amp Hermaphroditic Power System	**	RSM	1.27 mm Surface Mount Micro Socket	277	TC145	URSA™ I/O Crimp Terminal	214
MPS	5 mm PowerStrip™/30 Amp Dual Leaf Socket	204	RU8	0.80 mm High-Speed Edge Card Riser Kit	**	TC146	mPOWER™ Crimp Terminal	196
MPS-RA	5 mm PowerStrip™/30 Amp Right-Angle Power Socket	204	RVCN	FireHawk™ RVCN® Optical Cables	138	TC37	Micro Mate™ Crimp Terminal	236
MPSC	PowerStrip™/30 Amp Signal/Power Combo Socket	205	S1SD(T)	1 mm Micro Mate™ Socket Assembly, Double Row	235	TCMD	2 mm Tiger Eye™ IDC High-Reliability Header Cable	319
MPSC-RA	PowerStrip™/30 Amp Right-Angle Signal/Power Socket	205	S1SS(T)	1 mm Micro Mate™ Socket Assembly, Single Row	234	TCSD	2 mm Tiger Eye™ IDC Socket Cable	318
MPSS	5 mm PowerStrip™/30 Amp Power Cable	246	S2M	2 mm Tiger Eye™ Discrete Wire Socket	229	TD	2.54 mm Double Row Screw Machine Terminal	**
MPT	5 mm PowerStrip™/30 Amp Dual Blade Terminal	204	S2SD(T)	2 mm Tiger Eye™ Discrete Wire Socket Cable	240	TEM	0.80 mm Tiger Eye™ Micro Header	227
MPT-RA	5 mm PowerStrip™/30 Amp Right-Angle Power Terminal	204	SAL1	1 mm High-Speed Micro Plane Socket	**	TEMS	0.80 mm Tiger Eye™ Micro Header, Slim	227
MPTC	PowerStrip™/30 Amp Signal/Power Combo Terminal	205	SAL2	1 mm High-Speed Micro Plane Socket	**	TFC	1.27 mm Tiger Eye™ Cost-Effective Reliable Header	223
MPTC-RA	PowerStrip™/30 Amp Right-Angle Signal/Power Terminal	205	SCRES	AccliMate™ IP68 Sealed Circular Ethernet Cable Socket	218	TFM	1.27 mm Tiger Eye™ High-Reliability Header	222
MTLW	2.54 mm Flex Stack, Low Profile .025" SQ Post Header	300	SCRUS	AccliMate™ IP68 Sealed Circular USB 2.0 Panel Mount Socket	218	TFML	1.27 mm Tiger Eye™ High-Reliability Locking Header	222
MTMM	2 mm FlexYZ™ Modified Through-Hole Header	281	SD	2.54 mm Double Row Screw Machined Socket	**	TLE	2 mm Tiger Beam™ Cost-Effective Reliable Socket	291
MTMS	1.27 mm Flex Stack, Modified Micro Header	**	SDL	2.54 mm Double Row Low Profile Screw Machined Socket	**	TLH	0.50 mm Micro Blade & Beam Ultra-Low Profile Header	59
MTSW	2.54 mm Flex Stack, Modified SQ Post Header	298	SEAC	1.27 mm SEARAY™ High-Speed/High-Density Jumper	123	TLW	2.54 mm Flex Stack, Low Profile .025" SQ Post Header	300
MW	1 mm Flex Stack, Surface Mount Micro Board Header	265	SEAF	1.27 mm SEARAY™ High-Density Open-Pin-Field, Socket	25	TML	1.27 mm Shrouded Micro Header	275
NVA3E	NovaRay™ I/O 38999 Ultra Rugged Cable	103	SEAF-RA	1.27 mm SEARAY™ Right-Angle Open-Pin-Field, Socket	26	TMM-SM	2 mm Low Profile SMT Header	279
NVA3P	NovaRay™ I/O 38999 Ultra Rugged Panel Mount Cable	103	SEAF8	0.80 mm SEARAY™ Ultra-High-Density Array, Socket	29	TMM-TH	2 mm FlexYZ™ Low Profile Through-Hole Header	280
NVAC	NovaRay™ Extreme Density & Performance Cable	109	SEAF8-RA	0.80 mm SEARAY™ Right-Angle Open-Pin-Field, Socket	29	TMMH-SM	2 mm Flexible SMT Header	282
NVACE	NovaRay™ I/O Extreme Performance Cable	102	SEAFP	1.27 mm SEARAY™ Press-Fit High-Density Array, Socket	27	TMMH-TH	2 mm FlexYZ™ Flexible Through-Hole Header	283
NVACP	NovaRay™ I/O Panel Mount Cable Assembly	101	SEAFP-RA	1.27 mm SEARAY™ Press-Fit Right-Angle Array, Socket	**	TMS	2 mm Shrouded Quad Row Header	285
NVAF	NovaRay™ Extreme Density & Performance Socket	17	SEAM	1.27 mm SEARAY™ High-Density Open-Pin-Field, Terminal	25	TMSM	1.27 mm Through-Hole Micro Header	274
NVAM	NovaRay™ Extreme Density & Performance Terminal	17	SEAM-GP	1.27 mm SEARAY™ High-Density Guide Post Array, Terminal	26	TOLC	0.635 mm FOURRAY™ Quad Row SMT Terminal	267
NVAM-CT	NovaRay™ Terminal for NVAC Series	109	SEAM-RA	1.27 mm SEARAY™ Right-Angle Open-Pin-Field, Terminal	26	TS	2.54 mm Single Row Screw Machined Terminal	**
NVBF	NovaRay™ Backplane Socket	83	SEAM8	0.80 mm SEARAY™ Ultra-High-Density Array, Terminal	29	TSH	2 mm Shrouded Header	285
NVBM-RA	NovaRay™ Backplane Right-Angle Terminal	83	SEAMI	1.27 mm SEARAY™ 85 Ω High-Density Array, Terminal	27	TSM	2.54 mm SMT .025" SQ Post Header	296
NVC	NovaRay™ I/O Die Cast Panel Cage for NVACP	101	SEAMP	1.27 mm SEARAY™ Press-Fit High-Density Array, Terminal	27	TSS	2.54 mm Flex Stack, Shrouded Header	303
OPA	Optical Patch Adaptor	137	SEAR	1.27 mm SEARAY™ High-Density Riser, 85 Ω	27	TSSH	2.54 mm Shrouded .025" SQ Post Header	**
P1M	URSA™ I/O Ultra Rugged Board Mount Connector	215	SEI	1 mm Single Row One-Piece Interface	227	TST	2.54 mm Flex Stack, Shrouded Cable Header	317
P1PD(T)	URSA™ I/O Ultra Rugged Panel Mount Terminal Cable	214	SEM	0.80 mm Tiger Eye™ Micro Socket	227	TSW	2.54 mm Through-Hole .025" SQ Post Header	294
P1PDS	URSA™ I/O Metal Shell for Cable Terminal Housing	214	SEMS	0.80 mm Tiger Eye™ Slim Micro Socket	227	T1PD(T)	1 mm Micro Mate™ Panel Mount Terminal, Double Row	237
PCIE	1 mm PCI Express™ 3.0 Edge Card Socket	79	SESDT	0.80 mm Tiger Eye™ Discrete Wire Socket Cable Assembly	241	T1PS(T)	1 mm Micro Mate™ Panel Mount Terminal, Single Row	236
PCIE-G4	1 mm PCI Express™ 4.0 Edge Card Socket	80	SFC	1.27 mm Tiger Eye™ Cost-Efficient Reliable Socket	223	T1SD(T)	1 mm Micro Mate™ Terminal Assembly, Double Row	237
PCIE-G5	1 mm PCI Express™ 5.0 Edge Card Socket	80	SFM	1.27 mm Tiger Eye™ High-Reliability Socket	221	T1SS(T)	1 mm Micro Mate™ Terminal Assembly, Single Row	236
PCIE-LP	1 mm PCI Express™ Low Profile Edge Card Socket	79	SFMC	1.27 mm Tiger Eye™ Flexible Pin Count Socket	225	TW-SM	2 mm Flex Stack, Flexible Board Stacker, SMT	286
PCIEC	1 mm PCI Express™ 3.0 Internal Cable Assembly	125	SFML	1.27 mm Tiger Eye™ High-Reliability Locking Socket	221	TW-TH	2 mm FlexYZ™ Flexible Board Stacker, Through-Hole	286
PCIEC-G4	1 mm PCI Express™ 4.0 Internal Cable Assembly	125	SFPC	SFP+ Transceiver Cage for MECT/SFPE	**	2SN	2 mm Shunt	312
PCIEC-G5	1 mm PCI Express™ 5.0 Internal Cable Assembly	125	SFPE	SFP+ Copper I/O Cable Assembly	**	UCC8	FireFly™ Positive Latching Receptacle	135
PCOA	PCle™ Over-Fiber FireFly™ Adaptor Card	136	SFPK	SFP+ Cage and Connector Kit	**	UDF6	AcceleRate™ mP Signal/Power Combo Socket	23
PCRF-G4	PCI Express™ 4.0 High-Speed Test Cable	126	SFSD(T)	1.27 mm Tiger Eye™ Discrete Wire Cable, Double Row	239	UDM6	AcceleRate™ mP Signal/Power Combo Terminal	23
PCRF-G5	PCI Express™ 5.0 High-Speed Test Cable	126	SFSS(T)	1.27 mm Tiger Eye™ Discrete Wire Cable, Single Row	238	UEC5	FireFly™ Edge Card Socket	135
PCUE	PCle™ Over-Fiber FireFly™ Copper Flyover™ Cable	124	SHF	1.27 mm Shrouded IDC Header	324	UMPCT	mPOWER™ Ultra Micro Power Cable	195
PCUO	PCle™ Over-Fiber FireFly™ Optical Flyover™ Cable	134	SIB	2.54 mm One-Piece Interfaces	255	UMPE(T)	mPOWER™ Cable-to-Cable Assembly, Terminal	196
PES	6.35 mm PowerStrip™/40 Amp High Power Socket	206	SIBF	1.27 mm One-Piece Interfaces	**	UMPI(T)	mPOWER™ Cable-to-Cable Panel Mount Assembly, Socket	197
PESC	PowerStrip™/40 Amp Signal/Power Socket	207	SIR1	2.54 mm One-Piece Right-Angle Interfaces	255	UMPS	2 mm mPOWER™ Ultra Micro Power Socket	193
PESS	6.35 mm PowerStrip™/40 Amp Cable Assembly	248	SL	2.54 mm Low Profile Single Row Machined Socket	**	UMPT	2 mm mPOWER™ Ultra Micro Power Terminal	194
PET	6.35 mm PowerStrip™/40 Amp High Power Terminal	206	SLM	1.27 mm Tiger Buy™ Low Profile Micro Socket	278	UPPT	PowerStrip™/20 Amp Hermaphroditic Power System	203
PETC	PowerStrip™/40 Amp Signal/Power Terminal	207	SLW	2.54 mm Tiger Buy™ Low Profile Socket Strip	311	UPS	3.81 mm PowerStrip™/20 Amp Dual Leaf Power Socket	203
PHF	2.54 mm Press-Fit Socket	293	SMH	2.54 mm SMT Horizontal Socket	**	UPT	3.81 mm PowerStrip™/20 Amp Dual Blade Power Terminal	203
PHT	2.54 mm Press-Fit Terminal	293	SMM	2 mm Tiger Eye™ High-Reliability Socket	230	USB-A	Standard USB 2.0, A-Type	**
PMSD(T)	4.19 mm Power Mate™ Discrete Wire Cable, Double Row	243	SMS	1.27 mm Through-Hole Micro Socket	278	USB-AM	Standard USB 2.0, A-Type Plug	**
PMS(T)	4.19 mm Power Mate™ Discrete Wire Cable, Single Row	243	SNM	2.54 mm Micro Shunt	312	USB-B	Standard USB 2.0, B-Type	**
PTF	2 mm Press-Fit Socket	287	SNT	2.54 mm Shunt	312	USBR-A	High-Retention USB 2.0 Interface, A-Type	**
PTHF	2 mm PC/104-Plus™ Self-Nesting Socket	288	SO	Precision Board Stacking Standoff	60	USBR-B	High-Retention USB 2.0 Interface, B-Type	**
PIT	2 mm Press-Fit Terminal	287	SOLC	0.635 mm FOURRAY™ Quad Row SMT Socket	267	ZF1	1 mm Flat Flexible Cable (FFC) Socket	326
PTUO	PCle™ Over-Fiber FireFly™ Extended Temp Optical Cable	134	SQT	2 mm FlexYZ™ Cost-Effective Rugged Socket, Square Tail	289	ZF5S	0.50 mm Flat Flexible Cable (FFC) Socket	326
QFS	0.635 mm Q2™ Rugged Ground Plane Socket	40	SQW	2 mm FlexYZ™ Cost-Effective Rugged Socket, Solder Tail	289	ZLTM	2 mm Flex Stack, Shrouded Elevated Terminal Strip	284
QFS-EM	0.635 mm Q2™ Ground Plane Socket, Edge Mount	45	SS	2.54 mm Single Row Screw Machined Socket	**	ZML	1.27 mm Flex Stack, Shrouded Elevated Stacker	275
QFS-RA	0.635 mm Q2™ Ground Plane Socket, Right-Angle	45	SS4	0.40 mm Micro Blade & Beam Ultra-Fine Pitch Socket	57	ZSS	2.54 mm Flex Stack, Elevated Shrouded Header	303
QFSS	0.635 mm Q2™ Shielded Ground Plane Socket	41	SS5	0.50 mm Micro Blade & Beam Low Profile Socket	58	ZST	2.54 mm Flex Stack, Elevated Shrouded Cable Header	317
QMS	0.635 mm Q2™ Rugged Ground Plane Header	40	SSQ	2.54 mm Tiger Claw™ Pass-Through SMT Socket	306	ZSTMM	2 mm Flex Stack, Shrouded Elevated Cable Header	321
QMS-EM	0.635 mm Q2™ Ground Plane Header, Edge Mount	45	SSW	2.54 mm Tiger Buy™ Socket .025" SQ Post	304	ZW	2.54 mm Flex Stack, Flexible .025" SQ Board Stacker	302
QMS-RA	0.635 mm Q2™ Ground Plane Header, Right-Angle	45		2.54 mm Tiger Buy™ Through-Hole Socket	304			
QMSS	0.635 mm Q2™ Shielded Ground Plane Header	41						
QRF8	0.80 mm Q Rate™ Slim Body Ground Plane Socket	42						
QRF8-RA	0.80 mm Q Rate™ Slim Body Socket, Right-Angle	45						
QRM8	0.80 mm Q Rate™ Slim Body Ground Plane Header	42						
QRM8-RA	0.80 mm Q Rate™ Slim Body Header, Right-Angle	45						
QSE	0.80 mm Q.Strip™ High-Speed Ground Plane Socket	38						
QSFPC	Cage for FQSP	99						
QSFPC-D8	Cage for FQSP-D8	97						
QSFPC-DD	Cage for FQSP-DD	98						
QSH	0.50 mm Q.Strip™ High-Speed Ground Plane Socket	37						
QSH-RA	0.50 mm Q.Strip™ High-Speed Socket, Right-Angle	44						
QSS	0.635 mm Q.Strip™ High-Speed Ground Plane Socket	39						
QSS-RA	0.635 mm Q.Strip™ Ground Plane Socket, Right-Angle	44						
QTE	0.80 mm Q.Strip™ High-Speed Ground Plane Header	38						
QTH	0.50 mm Q.Strip™ High-Speed Ground Plane Header	37						

RF PRODUCTS

See page 335 for available RF Solutions.

GENERAL POLICY INFORMATION

Unless otherwise agreed by Samtec in writing, all sales of Samtec products are subject to Samtec's Terms and Conditions of Sale located at <https://www.samtec.com/about/legal#samtecterms>

Federal Supply Code: 55322

Notes:

Products available on website. **New products highlighted in bold.

Most older products not shown in the catalog are still available. Visit www.samtec.com and the homepage search bar for availability and specifications.

AVNET[®] ABACUS

High-Speed
Board-to-Board

High-Speed
Cables

Optics

RF

Rugged/Power

Flexible Stacking

SOUTH AFRICA

Block 13, Pinewood Office Park
33 Riley Road Woodmead,
ZA-2191 Sandton, Johannesburg
Phone/Fax: +27 (0)10 447 0180
avnet-abacus-sales-southafrica@avnet.eu

samtec
SUDDEN SERVICE[®]

www.samtec.com

© NOVEMBER 2023, SAMTEC INC.