

Harwin EMC shielding solutions

Harwin EMC shielding solutions

Sensitive electronic circuits need to be fully protected from extraneous Electro-Magnetic and Radio Frequency Interference (EMI and RFI). This has typically been achieved by mounting metal shields or 'cans' directly to the PCB to fully shroud the required circuitry. These shields are often attached to the PCB using through-hole solder tails, manually soldered after the main assembly process.

This process is not only time-consuming and costly, but also during initial setup and subsequent maintenance, it is often necessary to access the circuitry and components under the shields. This requires de-soldering operations in often densely populated areas containing highly sensitive components. As a result, there is a high risk of expensive damage occurring.

Harwin's solution of using shield retaining clips, supplied in industry-standard tape and reel packaging, provides an automatic placement method which is soldered using standard SMT placement equipment. The shielding can is then fitted during final assembly within seconds. As it is possible to remove and refit the can a number of times, tuning and rework operations are simplified, and a minimal risk of damage is ensured. Therefore, both initial production and rework costs are significantly reduced.

PRODUCT AND ENGINEERING SUPPORT FROM AVNET ABACUS' TECHNICAL SPECIALISTS

Avnet Abacus offers a broad range of board-level shielding products from Harwin, suitable for every stage of your design process, from prototype through to volume manufacturing and our European team of technical specialists is on hand to offer you the highest levels of engineering support.

To discuss your design requirements in your local language, contact this team online at [avnet-abacus.eu/ask-an-expert](https://www.avnet-abacus.eu/ask-an-expert) or call your local sales office.



SHIELD CANS AND CLIPS

Harwin's range of surface-mount shield clips and cans provide a straight-forward, easy-to-use board-level shielding solution.

The combination of SMT clips with a shield can provides a simple and cost-effective method of shielding vulnerable or EMI-radiating board components. Harwin's shield clips work with standard or custom can sizes from 0.13mm to 1mm thick.

With no secondary manual soldering operations, shield cans quickly and easily slot into the clips. This method avoids introducing hotspots from manual soldering, which could damage adjacent components. Rework or testing is now easy without a desoldering operation to access components under the can.

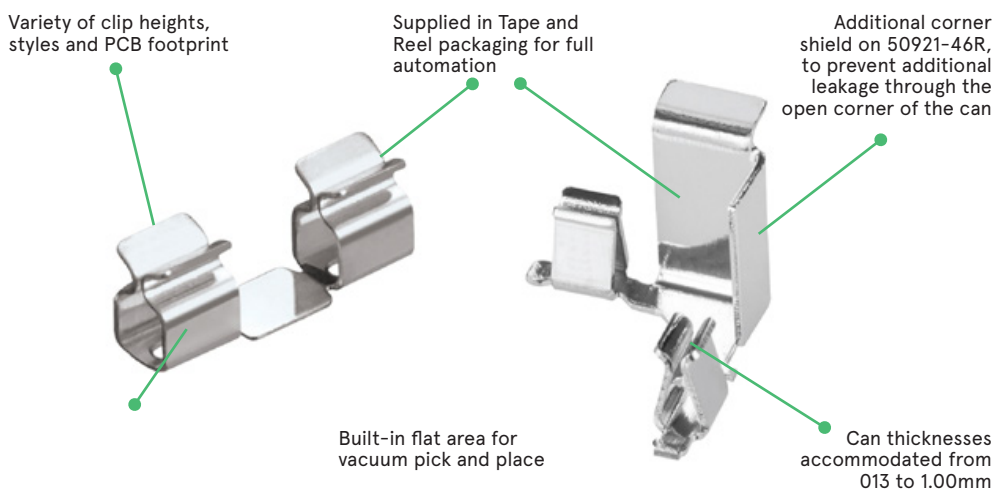
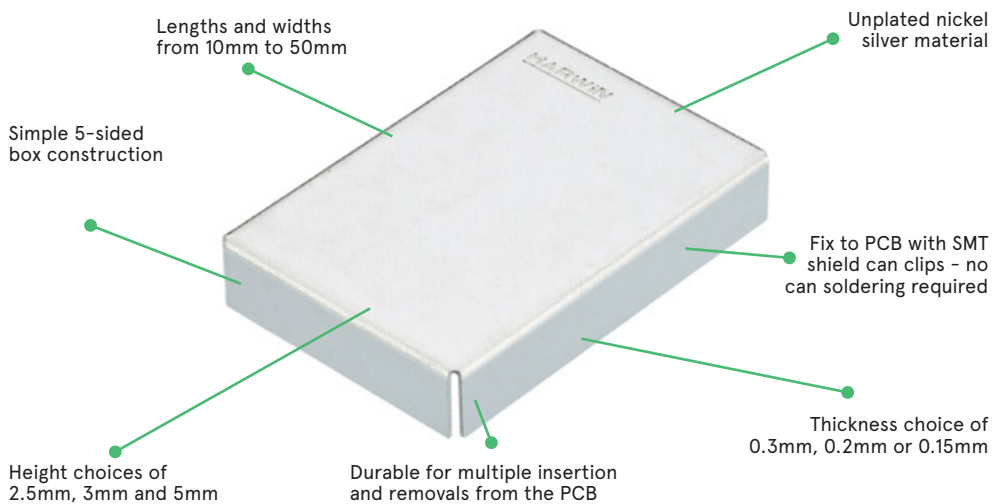

Applications

- Energy
- Telecommunications
- Motorsport
- Industrial
- Aviation, defence and security
- Space

Harwin EMC shielding solutions

SMT SPRING CONTACTS

Harwin's range of SMT Spring Contacts allow for flexibility when creating electrical and grounding connections.

Make a simple connection or get your PCB grounded with a Harwin Spring Contact – a single-piece metal connection point with inherent spring properties.

With many configurations and working heights, Spring Contacts are the perfect solution when space constraints are an issue. Ideal for blind mating and tolerant to both wiping and sliding actions. Provided on tape and reel for automated assembly and low production costs.

Spring contacts are also known by other names such as Shield Fingers, Antenna Contacts or Grounding Contacts, depending on the end application. Take advantage of the small sizes for antenna feeds in mobile devices, LED lamp connections, grounding metal elements or single signal connections.

Multi-directional, works in either vertical or horizontal compression
Gold or tin finish options

Gold or tin finish options

Wide range of working heights

Range of spring forces

Extended beam for lower spring forces

Positive stop to prevent over stressing

Antenna contacts in very small sizes

Box design to prevent snagging

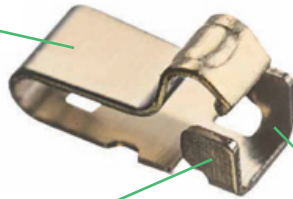
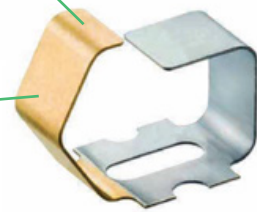

SHIELD CAN KIT

Everything you need to make your own customised size of shield can. This award-winning kit includes two pre-scored sheets, 24 shield can clips and an instruction sheet. Just add a ruler and a pair of scissors.

- Scored at 5mm intervals – simply cut the blank along the scores, then fold the 4 edges down.
- Ultimate flexibility for developers – try out different sizes for prototyping and development work.

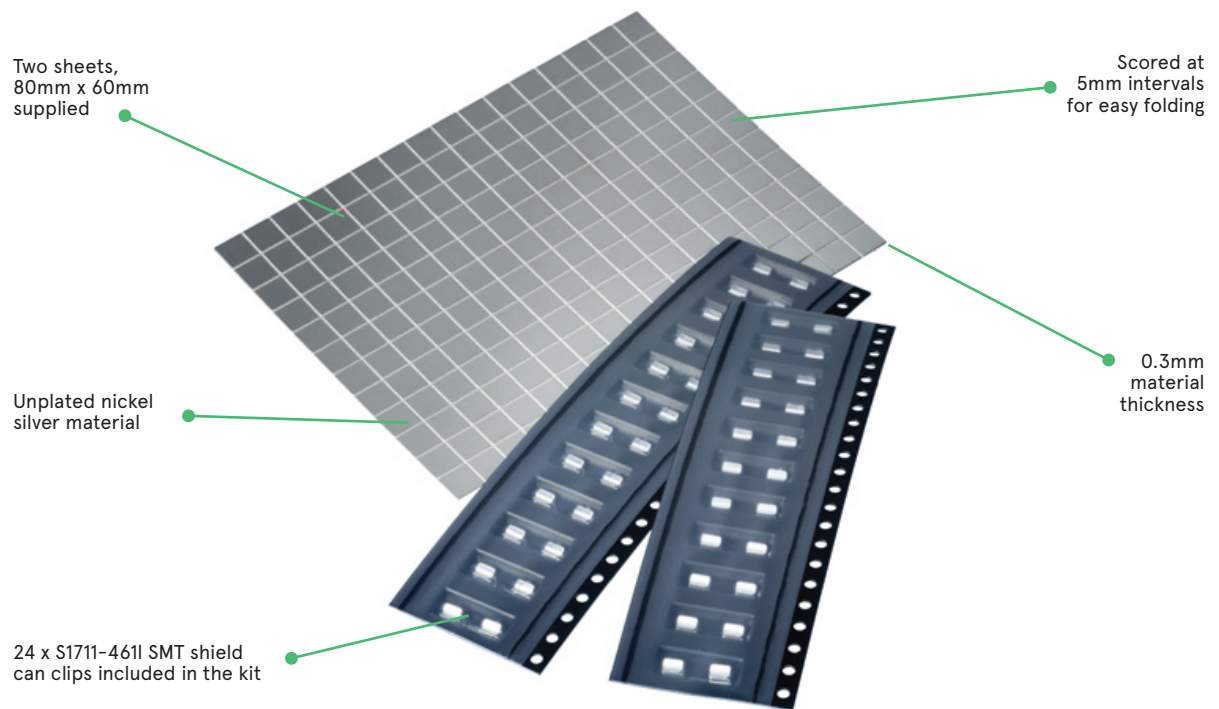

SPRING CONTACT DEVELOPMENT KIT

The Spring Contact Development Kit is the ideal prototyping kit for customers using SMT spring contacts. Containing 16 different contacts in strips of Tape and Reel, the kit is an easy reference library for Harwin's product range. Electronic design engineers at OEMs and design houses can now immediately try out one or more of the contacts by keeping this kit on hand, instead of waiting for the delivery of samples contacts.

Further reading/resources



SMT SPRING CONTACT DEVELOPMENT KIT AND PRIZE DRAW

The Spring Contact Development Kit is the ideal prototyping kit for customers using SMT Spring Contacts.

[MORE INFORMATION](#)



UNDERSTANDING EMC INSIDE AND OUT

As wireless communication becomes increasingly pervasive, mitigating the impact of electro-magnetic interference (EMI) is essential.

[READ ARTICLE](#)

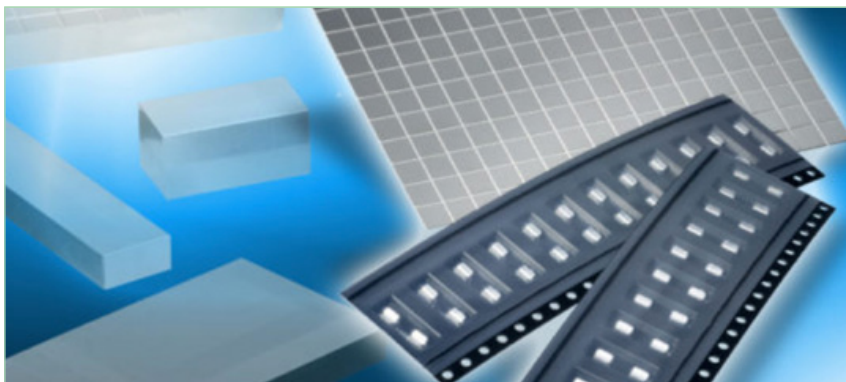

MORE ABOUT HARWIN'S EMC RANGE

Further information, technical details and downloads available on Harwin's EMC shielding.

[READ ARTICLE](#)

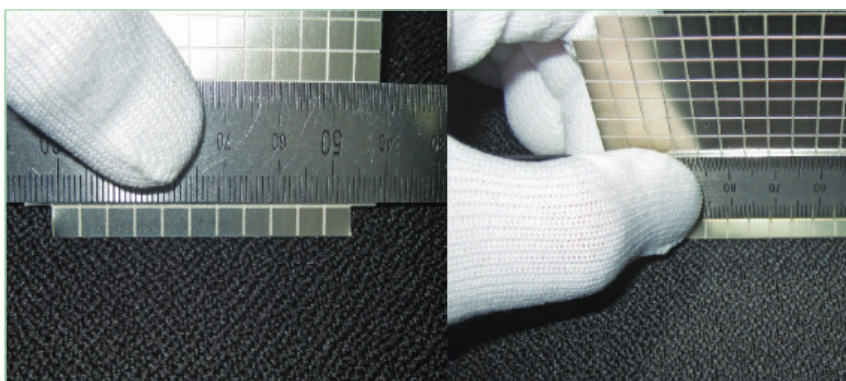

SHIELD CAN KIT INSTRUCTION SHEET

More details about the Harwin Shield Can kit.

[DOWNLOAD NOW](#)



Offices

AUSTRIA

Avnet Abacus Vienna
Avnet EMG Elektronische
Bauelemente GmbH
Grünbergstraße 15/1/4. OG
1120 Wien / Austria
Phone: +43 1 86642 0
wien@avnet-abacus.eu

BELARUS

c/o Avnet Abacus Russia
Office 24, Building 2
10 Korovinskoye Shosse,
127486 Moscow
Phone: +7 (495) 737 3688
Fax: +7 (495) 737 3686
belarus@avnet-abacus.eu

BELGIUM

De Kleetlaan 3
1831 Diegem
Phone: +32 2 227 2000
diegem@avnet-abacus.eu

BULGARIA

c/o Avnet Abacus Romania
4 Gara Herastrau,
Building B, 2nd Floor RO-020334
Bucharest
Phone: +4021 528 16 90
bulgaria@avnet-abacus.eu

CROATIA

c/o Avnet Abacus Slovenia
Dunajska Cesta 167
1000 Ljubljana
Phone: +386 (0)1 560 97 54
Fax: +386 (0)1 560 98 78
croatia@avnet-abacus.eu

CZECH REPUBLIC

Amazon Court Karolinska 661/4
CZ-18600 Prague Czech Republic
Phone: +420 234 091 011
Fax: +420 234 091 010
praha@avnet-abacus.eu

DENMARK

Knudlundvej 24 DK-8653 Them
Phone: +45 86 84 84 84
Fax: +45 86 84 82 44
them@avnet-abacus.eu

Lyskær 9, DK-2730 Herlev
Phone: +45 86 84 84 84
Fax: +45 43 29 37 00
herlev@avnet-abacus.eu

EGYPT

c/o Avnet Abacus Turkey
Tatlısu Mahallesi Pakdil
Sokak No: 7 Kat: 2 34774
Umraniye Istanbul Turkiye
Phone: +90 216 52 88 370
Fax: +90 216 52 88 377
egypt@avnet-abacus.eu

ESTONIA

Suur-Jõe 63, Pärnu,
80042 Pärnu Maakond,
Estonia
Phone: +372 56637737
paernu@avnet-abacus.eu

FINLAND

Pihatörmä 1 B
FI-02240 Espoo
Phone: +358 (0) 207 499 220
Fax: +358 (0) 207 499 240
espoo@avnet-abacus.eu

FRANCE

Immeuble Carnot Plaza
14 Avenue Carnot
91349 Massy Cedex, Paris
Phone: +33 (0) 1 6447 2929
Fax: +33 (0) 1 6447 9150
paris@avnet-abacus.eu

8 chemin de la Terrasse
Bat D 1er étage
31500 Toulouse
Phone: +33 (0) 5 6247 4787
Fax: +33 (0) 5 6247 4761
toulouse@avnet-abacus.eu

35 avenue des Peupliers
Les Peupliers2
35510 Cesson
Phone: +33 (0) 2 9983 7720
Fax: +33 (0) 2 9983 4829
rennes@avnet-abacus.eu

Parc Club du Moulin à Vent
Bât 10, 33 rue du Dr. G Lévy
F-69693 Vénissieux Cedex, Lyon
Phone: +33 (0) 4 7877 1370
Fax: +33 (0) 4 7877 1391
lyon@avnet-abacus.eu

GERMANY

Englische Str. 27
D - 10587 Berlin
Phone: +49 (0) 30 790 997 0
Fax: +49 (0) 30 790997 51
berlin@avnet-abacus.eu

Industriestr. 26
D-76297 Stutensee
Phone: +49 (0)7249 910 149
Fax: +49 (0)7249 910 177
stutensee@avnet-abacus.eu

Wilhelmstr. 1,
D-59439 Holzwickede / Dortmund
Phone: +49 (0) 2301 2959 27
Fax: +49 (0) 2301 2959 29
dortmund@avnet-abacus.eu

Oehleckerring 9a - 13 22419
Hamburg
Phone: +49 (0) 40 608 23 59 0
Fax: +49 (0) 40 608 23 59 20
hamburg@avnet-abacus.eu

Gruber Str. 60c-60d
D-85586 Poing / Munich
Phone: +49 (0) 8121 777 03
Fax: +49 (0) 8121 777 531
muenchen@avnet-abacus.eu

Lina-Ammon-Str. 19 b
D-90471 Nürnberg
Phone: +49 (0) 911 244 250
Fax: +49 (0) 911 244 25 25
nuernberg@avnet-abacus.eu

Gutenbergstr. 15
D-70771 Leinfelden- Echterdingen
/ Stuttgart
Phone: +49 (0) 711 78260 02
Fax: +49 (0) 711 78260 333
stuttgart@avnet-abacus.eu

Gaußstraße 10 D-31275 Lehrte
Phone: +49(0) 5132 5099 0
Fax: +49(0) 5132 5099 76
lehrte@avnet-abacus.eu

GREECE

c/o Avnet Avnet Serbia
Milentija Popovića 5B,
Floors 6-8 Belgrade RS11070
Phone: +381 11 4022302
Fax: +381 11 4049900
belgrade@avnet-abacus.eu

HUNGARY

c/o Avnet Abacus Czech Republic
GreenPoint Offices,
Blok F Turcianska 2 SK-82109,
Bratislava
Phone: +421 232 242 608
Fax: +421 2 32 1111 40
budapest@avnet-abacus.eu

IRELAND

c/o Avnet Abacus Bolton
Oceanic Building
Waters Meeting Road
Bolton BL1 8SW
Phone: +44 (0)1204 547170
Fax: +44 (0)1204 547171
bolton@avnet.eu

ISRAEL

Avnet Abacus Israel
1 Habrosh Street
Bney Dror 4581500
Phone: 972-9-778-0280
Israel@avnet-abacus.eu

ITALY

Via Manzoni 44
I-20095 Cusano Milanino (Milano)
Phone: +39 02 660 921
Fax: +39 02 66092 332
milano@avnet-abacus.eu

Viale dell'industria
23 I-35129 Padova
Phone: +39 049 7800 381
Fax: +39 049 7730 36
padova@avnet-abacus.eu

Via di Settebagni, 390
I-00138 Roma
Phone: +396-41231951
roma@avnet-abacus.eu

Via Scaglia Est, 31/33
41126 Modena
Phone: +39 059 34891
Fax: +39 059 344993
modena@avnet-abacus.eu

Via Panciattichi 40/11
I-50127 Firenze
Phone: +39 055 436 1928
Fax: +39 055 428 8810
firenze@avnet-abacus.eu

LATVIA

c/o Avnet Abacus Poland
Plac Solny 16
PL-50-062 Wroclaw
Phone: +48 71 34 205 99
Fax: +48 71 34 229 10
latvia@avnet-abacus.eu

LITHUANIA

c/o Avnet Abacus Poland
Plac Solny 16
PL-50-062 Wroclaw
Phone: +48 71 34 205 99
Fax: +48 71 34 229 10
lithuania@avnet-abacus.eu

NETHERLANDS

Stadionstraat 2, 6th fl. NL-4815
NG Breda
Phone: +31 (0) 76 57 22 300
Fax: +31 (0) 76 57 22 303
breda@avnet-abacus.eu

NORWAY

Olaf Helsetstvei 6,
0694 Oslo Norway
Phone: +47 (0) 94 89 53 73
oslo@avnet-abacus.eu

POLAND

Plac Solny 16
PL-50-062 Wroclaw
Phone: +48 71 34 205 99
Fax: +48 71 34 229 10
wroclaw@avnet-abacus.eu

PORTUGAL

Tower Plaza, Rot. Eng. Edgar
Cardoso,
23, Pl. 14, Sala E
PT-4400-676 Vila Nova de Gaia
Phone: +351 223 779502
Fax: +351 223 779503
portugal@avnet-abacus.eu

ROMANIA

4 Gara Herastrau, Building B,
2nd Floor
RO-020334 Bucharest
Phone: +4021 528 16 90
romania@avnet-abacus.eu

RUSSIA

49A Tatischeva Street,
Ekaterinburg
RUS-620028
Phone: +7 (912) 650 1944
Ekaterinburg@avnet-abacus.eu

Office 24, Building 2
10 Korovinskoye Shosse
127486 Moscow
Phone: +7 (495) 737 3688
Fax: +7 (495) 737 3686
Moscow@avnet-abacus.eu

SERBIA

Milentija Popovića 5B, Floors 6-8
Belgrade RS11070
Phone: +381 11 4022302
Fax: +381 11 4049900
belgrade@avnet-abacus.eu

SLOVAKIA

GreenPoint Offices, Blok F
Turcianska 2
SK-82109, Bratislava
Phone: +421 232 242 608
Fax: +421 2 32 1111 40
slovakia@avnet-abacus.eu

SLOVENIA

Dunajska Cesta 167
1000 Ljubljana
Phone: +386 (0)1 560 97 54
Fax: +386 (0)1 560 98 78
ljubljana@avnet-abacus.eu

SOUTH AFRICA

Block 13,
Pinewood Office Park
33 Riley Road Woodmead
2191 Sandton, Johannesburg
Phone: +27 (0) 10 447 0184
avnet-abacus-sales-southafrica@avnet.eu

Belmont Office Park
1st Floor, Unit 0030
Belmont Road, Rondebosch
Cape Town 7700
Phone: +27 (0) 21 200 8685
avnet-abacus-sales-southafrica@avnet.eu

33 Shelbourne Avenue La Lucia,
4051 Umhlanga
KwaZulu-Natal
Phone: +27 (0) 31 9405006
avnet-abacus-sales-southafrica@avnet.eu

SPAIN

NyN Tower, C/ Tarragona,
149-157, Floor 19
ES-08014 Barcelona
Phone: +34 (0) 93 327 85 50
Fax: +34 (0) 93 425 05 44
barcelona@avnet-abacus.eu

Plaza Zabalgane 12 Bajo Izda,
Galdakao / Vizcaya
ES -48960 Bilbao
Phone: +34 (0) 94 457 0044
Fax: +34 (0) 94 456 8855
bilbao@avnet-abacus.eu

C/Chile, 10 2ª Pta. Oficina 229
ES -28290 Las Matas / Madrid
Phone: +34 (0) 913 72 7200
Fax: +34 (0) 916 36 9788
madrid@avnet-abacus.eu

SWEDEN

Löfströms Allé 5,
Sundbyberg, Box 1830,
SE-171 27 Solna
Phone: +46 (0) 858 746200
Fax: +46 (0) 858 746 001
stockholm@avnet-abacus.eu

Smörhålevägen 3
SE-43442 Kungsbacka
Phone: +46 (0)8 58746 200
Fax: +46 (0)300 140 15
gothenburg@avnet-abacus.eu

SWITZERLAND

Bernstrasse 394
CH-8953 Dietikon
Phone: +41 (0) 43 322 49 90
Fax: +41 (0) 43 322 49 99
zurich@avnet-abacus.eu

TURKEY

Tatlısu Mahallesi Pakdil
Sokak No: 7 Kat: 2 34774
Umraniye Istanbul Turkiye
Phone: +90 216 52 88 370
Fax: +90 216 52 88 377
istanbul@avnet-abacus.eu

UK

Building 5 Waltham Park
White Waltham
Maidenhead Berkshire SL6 3TN
Phone: +44 (0)1628 512900
Fax: +44 (0)1628 512999
maidenhead@avnet.eu

Avnet House
Rutherford Close
Meadway, Stevenage
Hertfordshire SG1 2EF
Phone: +44 (0)1438 788 500
Fax: +44 (0)1438 788 250
stevenage@avnet.eu

Oceanic Building
Waters Meeting Road
Bolton BL1 8SW
Phone: +44 (0)1204 547170
Fax: +44 (0)1204 547171
bolton@avnet.eu

UKRAINE

c/o Avnet Abacus Poland
Plac Solny 16
PL-50-062 Wroclaw
Phone: +48 71 34 205 99
Fax: +48 71 34 229 10
ukraine@avnet-abacus.eu

All trademarks and logos are the property of their respective owners. This document provides a brief overview only, no binding offers are intended. No guarantee as to the accuracy or completeness of any information. All information is subject to change, modifications and amendments without notice. Printed on FSC certified paper.