



ITT

ASSEMBLY AND WIRING INSTRUCTION

MS / CA-BAYONET
Circular Connector

CAS25094E

1	General Information	2
1.0	Scope	2
1.1	Box Mounting Receptacle - Method of mounting.....	2
2	Connector Components Bayonet.....	3
2.0	Explosion View Shell Assembly (Box Mounting Receptacle)	3
2.1	Explosion View Barrel Assembly (Straight Plug)	3
3	Connector Components Thread	4
3.0	Explosion View Shell Assembly (Box Mounting Receptacle)	4
3.1	Explosion View Barrel Assembly (Straight Plug)	4
3.2	Connector Components	5
4	Contacts and Assembly Tools	7
4.0	Standard Crimp Contacts	7
4.1	Crimping Tools Description.....	8
4.2	Crimping Tools Order references	9
4.3	Insertion Tools	10
4.4	Extraction Tools	11
4.5	Pipe Wrench	11
4.6	Instructions for the crimping process of Machined Contacts	11
5	Preparation	12
5.0	Dimensions for Single Conductor and Wire Stripping	12
5.1	Wire Stripping Length and Selector Proposal.....	12
5.2	Wire Hole Fillers.....	13
6	Soldering contacts	13
6.0	Soldering Tools	14
7	Assembly of Contacts	14
7.0	Overview, Configuration and Preparation for Contact Installation.....	14
7.1	Insertion of Contacts	15
8	Assembly Instruction for the Endbell Style M	18
9	Removal of Contacts	22
10	Annex.....	23
10.0	Useful Hints.....	23
10.1	Product Safety Information	24

Bearbeitet: AKU	Geprüft: BR/FA	Norm:	Änd.-Stand: A 4411W	Änd.-Datum: 24.01.2013
---------------------------	--------------------------	-------	-------------------------------	----------------------------------



ASSEMBLY AND WIRING INSTRUCTION

MS / CA-BAYONET
 Circular Connector

CAS25094E

1 General Information



1.0 Scope

This assembly manual is made for users of ITT Cannon connectors to provide information and practical instructions concerning connector design, construction and wiring operations. It is referring to connector series:

CA-B; VG 95234

MS/CA; MIL-C-5015/ VG 95342

CA/COM; CA-COM-B

The purpose of this manual is to describe the assembling procedures of our connectors and contacts to facilitate the connection with any kind of cable. It also gives an overview to the handling of relevant tools.

For detailed specifications of each series see specific catalogues

To download specific connector drawings or 3D models by inserting connector description (e.g. CA 3106E10SL-3P-B-03) into the search field on the website: www.ittcannon.com

1.1 Box Mounting Receptacle - Method of mounting

A box mounting receptacle is usually mounted to a panel either rear or front mounting This is done via four screws.

The straight plug in combination with the Universal Endbell and an o-ring between flange receptacle and wall the connector will reach IP68 sealing (1bar, 16h) and IP69K sealing.

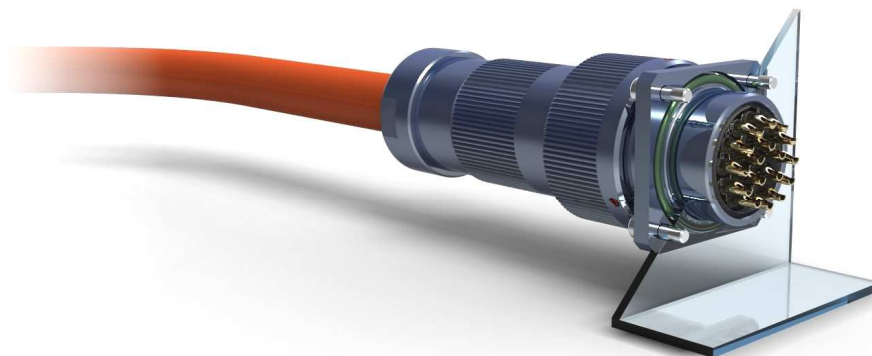

Bearbeitet:	Geprüft:	Norm:	Änd.-Stand:	Änd.-Datum:
AKU	BR/FA		A 4411W	24.01.2013

ITT Cannon GmbH, D-71384 Weinstadt



2 Connector Components Bayonet

2.0 Explosion View Shell Assembly (Box Mounting Receptacle)

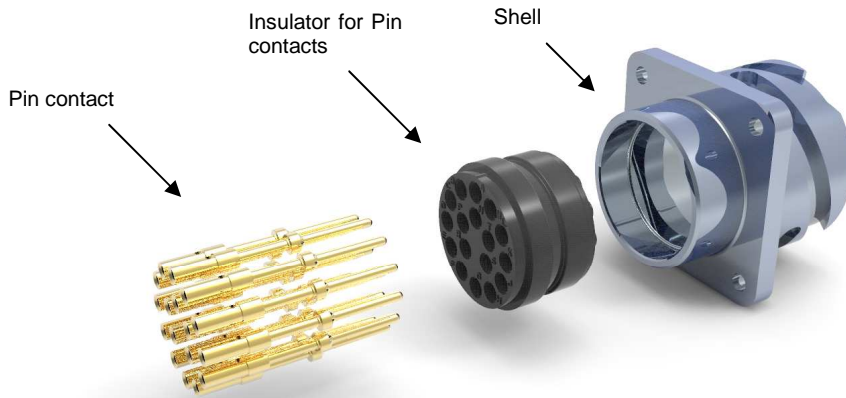

2.1 Explosion View Barrel Assembly (Straight Plug)

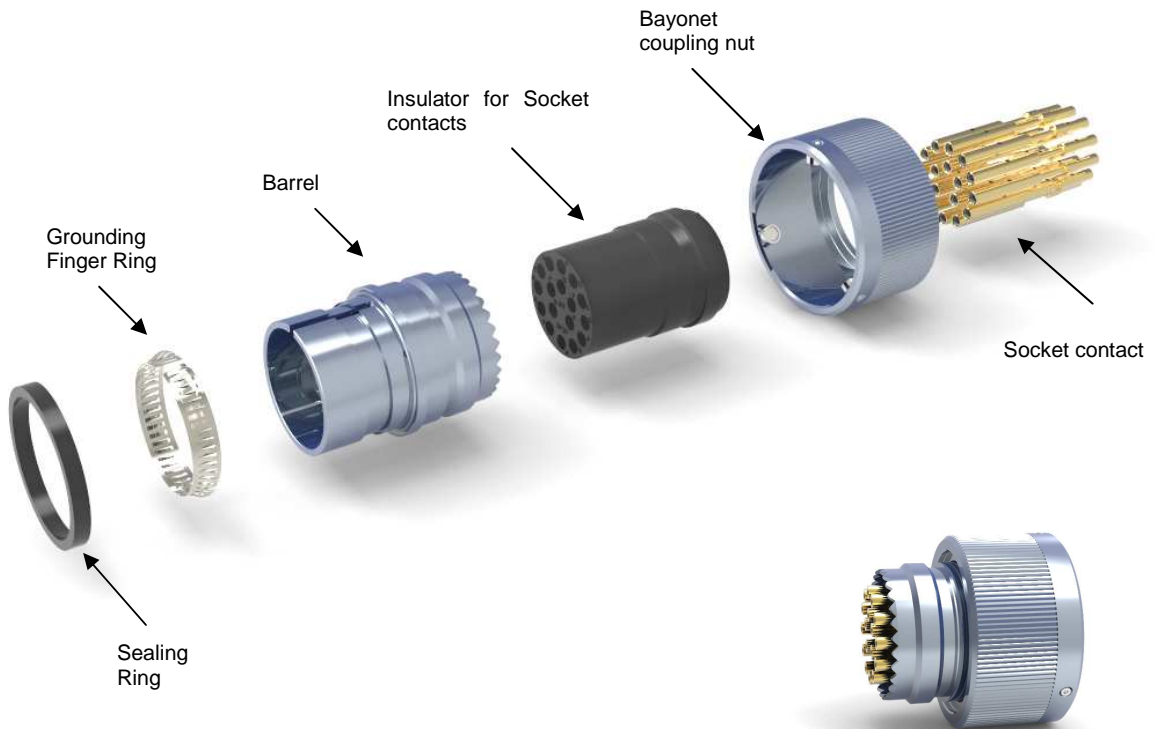

Bearbeitet: AKU	Geprüft: BR/FA	Norm:	Änd.-Stand: A 4411W	Änd.-Datum: 24.01.2013
--------------------	-------------------	-------	------------------------	---------------------------



3 Connector Components Thread

3.0 Explosion View Shell Assembly (Box Mounting Receptacle)

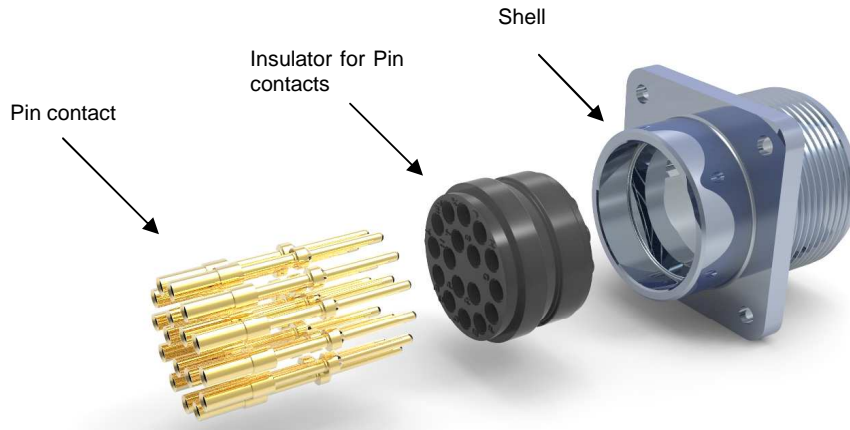

3.1 Explosion View Barrel Assembly (Straight Plug)

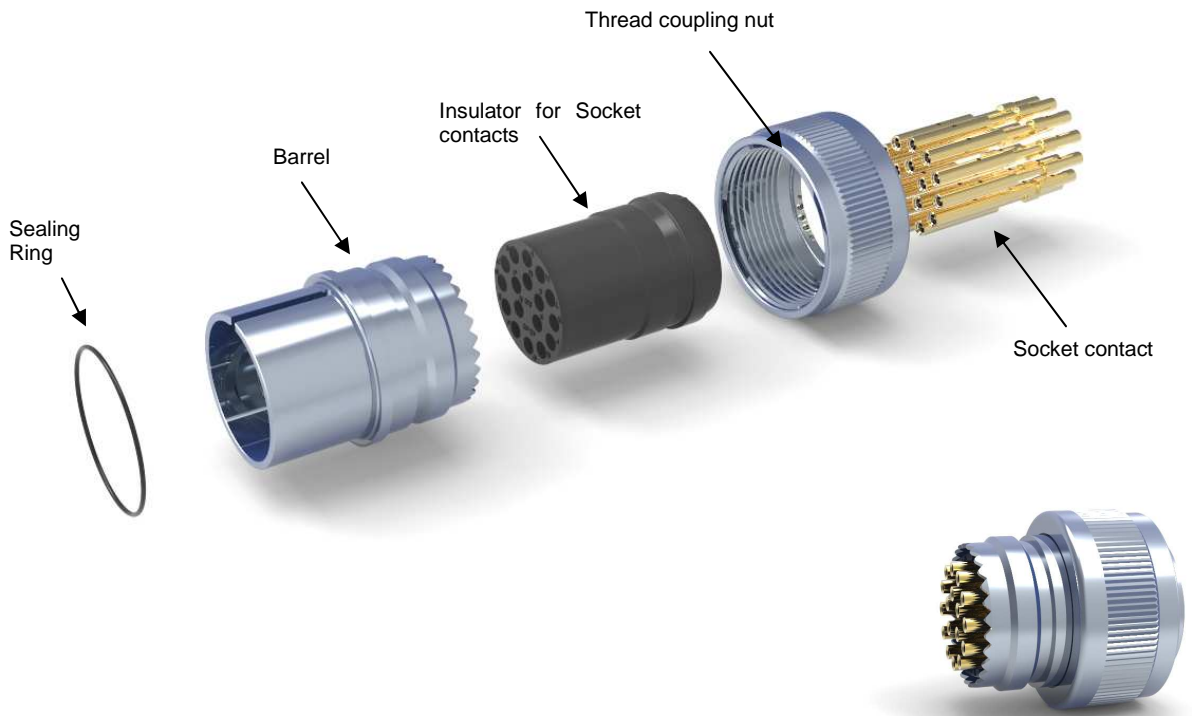

Bearbeitet: AKU	Geprüft: BR/FA	Norm:	Änd.-Stand: A 4411W	Änd.-Datum: 24.01.2013
--------------------	-------------------	-------	------------------------	---------------------------



ITT

ASSEMBLY AND WIRING INSTRUCTION

MS / CA-BAYONET
Circular Connector

CAS25094E

3.2 Connector Components

Grommet: It ensures sealing of the individual wires against ingress, provided that the backshell is tightened and the individual wire size is adequate.



Ferrule: When the endbell is tightened, the compression ring is applied to the grommet and consequently to the jacket of the individual wires.

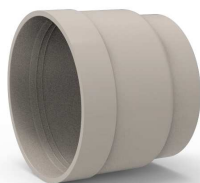

Coupling nut: It performs the mating and unmating operations with the relevant receptacle.

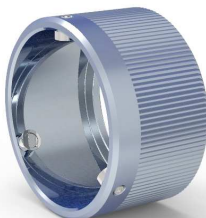

Contacts: There are three different kinds of contacts:

- crimp contacts (AWG and metric)
- solder contacts
- PCB contacts (no specific tool needed)



Pin



Socket

Bearbeitet:

AKU

Geprüft:

BR/FA

Norm:

Änd.-Stand:

A 4411W

Änd.-Datum:

24.01.2013



ITT

ASSEMBLY AND WIRING INSTRUCTION

MS / CA-BAYONET
Circular Connector

CAS25094E

Insulator: It isolates the contacts one from each other and from the plug shell. The insulator is already mounted into the Barrel. Solder contacts are pre installed while crimp contacts have to be inserted into the relevant contact cavity after the crimping process.



Backshell / Endbell: Provides the harnessing space and guarantees the strain relief of the cable. Heatshrinkboot endbells must be combined with the appropriate heatshrinkboot to complete the assembly. Heatshrinkboots have to be purchased separately!

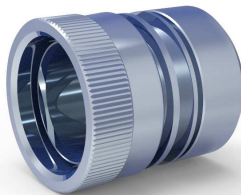

Adapter: Is featured with a threaded back end to connect accessories for cable clamping (like a PG or metric gland)
PG or metric glands have to be purchased separately!



Bearbeitet:

AKU

Geprüft:

BR/FA

Norm:

Änd.-Stand:

A 4411W

Änd.-Datum:

24.01.2013



ITT

ASSEMBLY AND WIRING INSTRUCTION

MS / CA-BAYONET
Circular Connector

CAS25094E

4 Contacts and Assembly Tools

4.0 Standard Crimp Contacts

Contact Size	Wire size mm ²	Wire size AWG	Pin Contact Part - No. A36	Pin Contact Part - No. A176	Socket Contact Part - No. A36	Socket Contact Part - No. A176
10 / 20	0,14 - 0,38	26 / 22	030-8585-010	030-8585-016	031-8554-010	031-8554-016
	0,5 - 1,0	20 / 18	030-8585-000	030-8585-006	031-8554-000	031-8554-006
15S / 16S	0,14 - 0,38	26 / 22	030-8586-010	030-8586-016	031-8555-130	031-8555-136
	0,3 - 0,6	22 / 20	330-8744-000	330-8744-006	031-8688-110	031-8688-116
	0,75 - 1,5	18 / 16	030-8586-000	030-8586-006	031-8555-110	031-8555-116
15 / 16	0,14 - 0,38	26 / 22	030-8587-030	030-8587-036	031-8556-130	031-8556-135
	0,3 - 0,6	22 / 20	330-8659-000	330-8659-006	031-8639-120	031-8639-115
	0,75 - 1,5	18 / 16	030-8587-000	030-8587-006	031-8556-110	031-8556-115
	1,5 - 2,0	16 / 14	030-8587-010	030-8587-016	031-8556-140	031-8556-145
	2,0 - 3,0	14 / 12	030-8587-020	030-8587-026	031-8556-120	031-8556-126
25 / 12	0,3 - 0,6	22 / 20			031-8557-040	031-8557-046
	0,75 - 1,5	18 / 16	030-8588-010	030-8588-016	031-8557-020	031-8557-026
	2,0 - 3,0	14 / 12	030-8588-000	030-8588-006	031-8557-000	031-8557-006
	4,0		030-8588-054	030-8588-060	031-8557-010	031-8557-016
	6,0	10			031-8557-030	031-8557-036
60 / 100 / 8	2,0 - 3,0	14 / 12	030-8612-010	030-8612-016	031-8519-010	031-8519-016
	4,0		030-8612-020	030-8612-026		
	6,0	10	030-8589-000	030-8589-006	031-8558-000	031-8558-006
	10,0	8	030-8612-000	030-8612-006	031-8519-000	031-8519-006
160 / 4	10,0		030-8590-000	030-8590-006	031-8559-000	031-8559-006
	10,0		030-8591-020	030-8591-026	031-8560-020	031-8560-026
	16,0	6	030-8613-010	030-8613-016	031-8520-010	031-8520-016
500 / 0		4	030-8591-000	030-8591-006	031-8560-000	031-8560-006
			030-8614-030	030-8614-006	031-8520-000	031-8520-006
	16,0		030-8614-030	030-8614-036	031-8521-030	031-8521-036
	25,0	4	030-8614-010	030-8614-016	031-8521-010	031-8521-016
	35,0	2	030-8614-020	030-8614-026	031-8521-020	031-8521-026
	50,0		030-8592-000	030-8592-006	031-8561-000	031-8561-006
			030-8614-000	030-8614-006	031-8521-000	031-8521-006

Bearbeitet:

AKU

Geprüft:

BR/FA

Norm:

Änd.-Stand:

A 4411W

Änd.-Datum:

24.01.2013



ITT

ASSEMBLY AND WIRING INSTRUCTION

MS / CA-BAYONET
Circular Connector

CAS25094E

4.1 Crimping Tools Description



Introduction

This hand crimp tool fully meets the requirements of specification MIL- C- 22520. The tool produces an eight- indent crimp termination of excellent quality. Using the correct turret with the tool and adjusting the selector knob as indicated on the turret to one of the eight different crimp depths, a large variety of MS and other contacts can be terminated. The standard tool M 22520/1-01 terminates wire sizes AWG 12-26 with contacts size 10, 16S, 16 and 12.

A table on the turret shows the crimp depths which have to be adjusted for each combination of contact and wire sizes. A cycle- control mechanism ensures that the complete crimp operation has been fully completed. Over- or undercrimping can be avoided by choosing the right selector position.

Dimensions

22x 60x22mm (closed, without locator)

Weight

Approx. 800g (without turret)

Crimp Locator

Crimp Locator guide and centralise the contact and place in the correct crimp position. They are screwed to the crimp tool using an Allen wrench size 9/64" A/F. Different turrets are available for different ITT Cannon connector series. The other references are contained in the applicable catalogues or assembly instructions. See page 9.

Testing

The hand crimp tool M22520/3-1. The tool is set into position "4". The handles are then fully closed. The "GO" side of the gauge must pass freely between the indenter tips, whereas the "NO-GO" side must not pass.

Note: DO NOT CRIMP GAUGE!



Bearbeitet: AKU	Geprüft: BR/FA	Norm:	Änd.-Stand: A 4411W	Änd.-Datum: 24.01.2013
--------------------	-------------------	-------	------------------------	---------------------------



ASSEMBLY AND WIRING INSTRUCTION

MS / CA-BAYONET
Circular Connector

CAS25094E

4.2 Crimping Tools Order references



Hand crimping tool M22520/1-01

Order No.: 995-0001-585

This universal tool features just one crimp turret with different adjustments for crimping contacts.

The tool provides an 8-indent crimp.



Pneumatic crimping tool WA27F-CE

Order No.: 121586-5067

Pneumatic operated crimp tool for higher volume production. A pedal for foot operation can also be provided.

The tool provides an 8-indent crimp.

Name	Order-No.	Description
WA27F-CE	121586-5067	Pneumatic crimp tool (AWG12-20)
WA22-CE	121586-5070	Pneumatic crimp tool (AWG20-32)
BM-2	121586-5068	Bench mount
WA10	121586-5069	Foot pedal (without picture)
M22520-3-1	995-0001-684	Gauge



Contact Size	Locator for Pin-Contact	Locator for Socket-Contact
15S / 16S	TH 452 or 600 324	TH 452 or 600 325
15 / 16	TH 452	TH 452
25 / 12	TH 452	TH 452
10 / 20	600 325	600 325



Illustration only

Semi-automatic crimp station

Available on request

With the semi-automatic crimp station up to 30 contacts per minute can be connected.

The crimp station is to be used for high volume production.

Bearbeitet: AKU	Geprüft: BR/FA	Norm:	Änd.-Stand: A 4411W	Änd.-Datum: 24.01.2013
--------------------	-------------------	-------	------------------------	---------------------------



ASSEMBLY AND WIRING INSTRUCTION

MS / CA-BAYONET
Circular Connector

CAS25094E



Hydraulic hand crimping tool HPW400U-ITT
Order No.: 121586-5257

Hydraulic hand crimping tool for crimping contacts of size 60/100/8, 160/4 and 500/0.



Hydraulic-electro tool complete HP400EL-ITT
Order No.: 121586-5253

Hydraulic tool with electric pump for crimping contacts of size 60/100/8, 160/4 and 500/0.

The aggregate is connected with a high-pressure hose to the crimping tool.

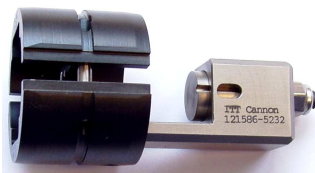

Contact Size	Crimp dies for hydraulic tool	Wrench Size	Locator
60/100/8	CT 121586-5231	5,20	CT 121586-5232
160/4	CT 121586-5230	7,25	
500/0	CT 121586-5229	11,40	

4.3 Insertion Tools

To insert crimped contacts into the insulator insertion tools are required.



Insertion tool CIT



Insertion pliers CIT-F80

Description	Name	Order No.
insertion tool for contact size # 10	CIT-20	121086-3009
insertion pliers for contact size # 10	CIT-F80-20	121086-0098
insertion tool for contact size # 16	CIT-16	121086-3008
insertion pliers for contact size # 16	CIT-F80-16	121086-0097
insertion tool for contact size # 12	CIT-12	121086-3007
insertion pliers for contact size # 12	CIT-F80-12	121086-0096
insertion tool for contact size # 8	CIT-8	121086-0095
insertion tool for contact size # 4	CIT-4	121086-0094
insertion tool for contact size # 0	CIT-0	121086-0093
guide pin #12		27977-12T8
guide pin #16		27977-16T50

ATTENTION:

A proper installation is only ensured if the required insertion tools are used.

Guide pins allow easy insertion of socket contacts sizes 15S/16S, 15/16 and 25/12 into the insulator. Without the use of these guide pins during contact insertion the insulator/contacts may be damaged.

Bearbeitet: AKU	Geprüft: BR/FA	Norm:	Änd.-Stand: A 4411W	Änd.-Datum: 24.01.2013
--------------------	-------------------	-------	------------------------	---------------------------



ASSEMBLY AND WIRING INSTRUCTION
MS / CA-BAYONET
 Circular Connector

CAS25094E

4.4 Extraction Tools

In case a contact has to be exchanged the following extraction tools are to be used:



Extraction Tools

Description	Name	Order No.
extraction tool for contact size # 16	CET-F80-16	121086-0081
extraction tool for contact size # 12	CET-F80-12	121086-0080
extraction tool for contact size # 8	CET-8	121086-0079
extraction tool for contact size # 4	CET-4	121086-0094
extraction tool for contact size # 0	CET-0	121086-0077

ATTENTION:

A proper removing of contacts is only ensured if the required extraction tools are used.

4.5 Pipe Wrench



Soft Jaw Adjustable Pliers

order No.: 550014-1644

for tightening the endbell housing

4.6 Instructions for the crimping process of Machined Contacts

- 1.) strip wires to lengths, for stripping details see 5.1
- 2.) open hand tool and insert the contact in the crimp profile
- 3.) position the stripped cable into the contact crimp pot
- 4.) press hand tool to end position
- 5.) open hand tool and extract the contact, check the contact visually
- 6.) minimum crimp tensile requirements see DIN EN 60352-2-2006

- there shall be no loose strands out of the crimp section
- the contact must be crimped straight to the cable
- deformed contacts must not be used. In this case crimp again
- while the preparation, strands must not be injured or cut

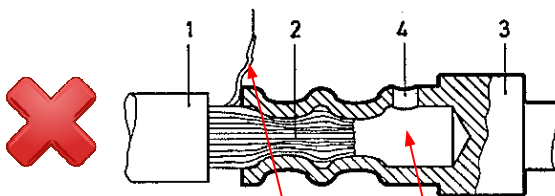
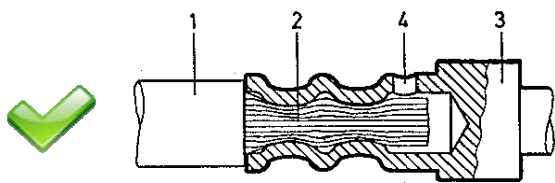

- 1 insulation of cable
- 2 wire
- 3 contact
- 4 inspection hole (wire strands must be visible)

no wire strand visible
 loose wire strand

Bearbeitet: AKU	Geprüft: BR/FA	Norm:	Änd.-Stand: A 4411W	Änd.-Datum: 24.01.2013
--------------------	-------------------	-------	------------------------	---------------------------

ITT
ASSEMBLY AND WIRING INSTRUCTION
MS / CA-BAYONET
Circular Connector
CAS25094E

5 Preparation

5.0 Dimensions for Single Conductor and Wire Stripping

All connectors for which these instructions are applicable are designed to be wired with cables according to MIL-W-5086 and TL6145-011.

Using other wire types please note:

1. wire insulation has to be waterproof (no braid but smooth surface)
2. dimensions have to correspond to following table:

Contact size		Conductor dimensions		Insulation dimensions Waterproof / Ø mm		Insulation dimensions Spray waterproof / Ø mm	
AWG	metric	AWG	mm ²	min	max	min	max
-	10	-	0,75 – 1,0	1,5	3,0	-	-
16S/16	15S/15	16	0,75 – 1,5	1,6	3,3	-	-
12	25	12	2,5	2,9	4,3	1,6	3,3
-	60	-	6,0	3,5	5,8	2,9	4,3
8	100	8	10,0	4,2	6,5	-	-
4	-	4	-	6,9	9,4	4,2	5,7
-	160	-	16,0	5,5	6,2	7,0	9,4
0	500	0	50,0	10,5	14,0	10,6	14,0

If wires with a smaller insulation diameter are used their diameter has to be increased by using a shrinking tube to correspond with the diameter in the grommet sealing area.

If these requirements are not fulfilled no guarantee can be given for correct connection between the contact and the conductor nor can be guaranteed that the connector meets its sealing capabilities

5.1 Wire Stripping Length and Selector Proposal

Stripping can be performed either thermically or mechanically. Note: Do not twist conductors used with crimp contacts. Do not touch un-insulated conductors before crimping. Twisting of conductors and grease or lubricants on the wires causes poor crimp quality.

Contact size	Wire stripping length in mm	Selector proposal
10 / 20	4,0 +0,4	4
15 / 16	6,0 +0,5	5 / 6
25 / 12	6,0 +0,5	7 / 8
60 / 100 / 8	11,0 +0,8 / -0,4	Hex 5,20
160 / 4	11,0 +0,8 / -0,4	Hex 7,25
500 / 0	13,0 +0,8 / -0,4	Hex 11,40

Attention:

Do not damage wire insulation! For solder connections wires have to be pre-tinned.

Bearbeitet:

AKU

Geprüft:

BR/FA

Norm:

Änd.-Stand:

A 4411W

Änd.-Datum:

24.01.2013



ITT

ASSEMBLY AND WIRING INSTRUCTION

MS / CA-BAYONET
Circular Connector

CAS25094E

5.2 Wire Hole Fillers

Where contacts are not used, the cavities are to be closed by wire holes filler.

size	VG95234 part no.	contact size		colour	part no.
		AWG	metric in mm ²		
20	VG95234B20	-	0,75-1,0	red	225-1000-000
16S	VG95234B16S	16	0,75-1,5	nature	225-8510-000
16	VG95234B16	12	2,5	blue	225-1017-000
12	VG95234B12	-	6,0	yellow	225-1018-000
8	VG95234B08	8	10,0	white	225-1019-000
4	VG95234B04	4	16,0	green	225-8502-000
0	VG95234B00	0	50,0	black	225-8503-000

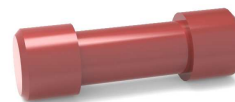

Assembly hint: None used contact cavities have to be closed by an unwired contact, while the relevant wire hole filler has to be inserted into the empty cavity of the grommet.

6 Soldering contacts

Pull wire through rear accessories such as ferrule, endbell and cable clamp. Make sure that the wires are inserted through the correct cavity of the grommet. Use Isopropyl alcohol for easier wire insertion through the grommet. Finally, solder conductors to the contacts by use of correct solder tin as well as solder flux. Preferably soldering is started at center contacts and proceeded as shown below:

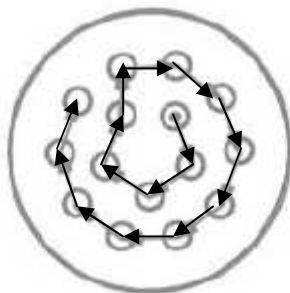

Make sure that soldering is performed as quickly as possible in order to prevent any excessive heat on the insulator to avoid insulator damage. Insert a contact into any empty grommet cavity and seal it with a sealing plug.

Soldering Process for contacts size 16 and 12:

Soldering device: Weller WS51, bit 3mm diameter

Temp. of soldering iron: 350 °C

Procedure: The soldering iron touches the solder contact approximately at half of the height of the solder cup and is wetted with some solder for better transmission of heat. After a short time of preheating, a certain amount of solder is melted at the upper end of the solder cup. Heat is applied until the solder has flown into the cup and has wetted the surface. Afterwards the wire is inserted.

Bearbeitet: AKU	Geprüft: BR/FA	Norm:	Änd.-Stand: A 4411W	Änd.-Datum: 24.01.2013
--------------------	-------------------	-------	------------------------	---------------------------



ASSEMBLY AND WIRING INSTRUCTION

MS / CA-BAYONET
Circular Connector

CAS25094E

Soldering Process for contacts sizes 8;4 and 0:

Soldering device: ERSA 300 (power: 300W)

Temp. of soldering iron: uncontrolled

Procedure: Before each soldering process the iron is cooled down for 10 seconds. Afterwards the iron is wetted with solder and applied outside the solder cup. After a certain time of pre- heating solder is put into the solder cup all around near the upper edge of the cup. When the solder has melted and flown into the solder cup, solder is added to larger areas which the solder has not yet wetted but where the solder has only flown around. Afterward the wire is inserted.

6.0 Soldering Tools



Soldering Station



Soldering Iron

7 Assembly of Contacts

7.0 Overview, Configuration and Preparation for Contact Installation

1. Pull crimped contact through all accessories used, such as ferrule, endbell and cable clamp
2. Make sure contacts are pushed through the right grommet cavity
3. Use Isopropyl alcohol for easier insertion.
4. Fix the shell with coupling nut in the assembly adapter and mate with each other

Usually an empty mating half shell as utilized to fix the connector in an appropriate manner.

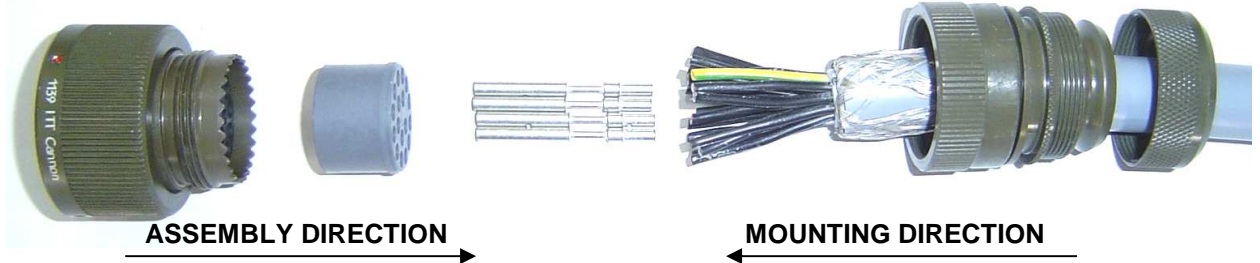

For longer cable lengths or for applications with already connected cables, slide all parts on the cable before assembling contacts into barrel and insulator.

Pay attention to the correct order and mounting direction of all parts, as pictured.

Bearbeitet: AKU	Geprüft: BR/FA	Norm:	Änd.-Stand: A 4411W	Änd.-Datum: 24.01.2013
--------------------	-------------------	-------	------------------------	---------------------------



ITT

ASSEMBLY AND WIRING INSTRUCTION

MS / CA-BAYONET
Circular Connector

CAS25094E

The second option is to crimp the contacts before you slide all parts over the cable, see illustration below



7.1 Insertion of Contacts

1. Use insertion tool as described on page 10. Place wired contact into insertion tool. Contact, wire and insertion tool have to be axial to each other. The insertion tool has to butt against the connector shoulder.
2. Push the contact into the insulator (contact cavity) by applying slow, continuous pressure until it snaps into its position. Hold tool vertically to insulator surface during the operation.
3. Remove the insertion tool cautiously.
4. Do not install damaged or bent contacts. If a contact is damaged during insertion it has to be removed. Install a new contact. If the insulator or grommet is damaged it must be replaced.
5. Check connector on the mating side to ensure all contacts are on the same level.

1



- Plug on and fix the connector for assembling.
- Use therefore an assembly adapter or an empty shell / housing.

2



- Assemble socket contacts sizes 15S/16S/15/16/12 and 25 only by using guide pins (see page 10).
- Insert guide pin into contact mating side.

Bearbeitet: AKU	Geprüft: BR/FA	Norm:	Änd.-Stand: A 4411W	Änd.-Datum: 24.01.2013
--------------------	-------------------	-------	------------------------	---------------------------



ASSEMBLY AND WIRING INSTRUCTION

MS / CA-BAYONET
Circular Connector

CAS25094E

3



- Moisten the contacts with Isopropyl alcohol for easier contact insertion.

4



- Position the grommet. Make sure that the grommet is placed in the right direction with bunch above.

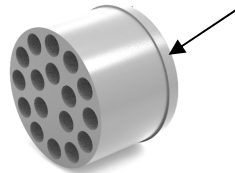

5



- Pre-insert the contacts in the insulator.
- Contact insertion is preferably started in the center of the insulator.

Bearbeitet:

AKU

Geprüft:

BR/FA

Norm:

Änd.-Stand:

A 4411W

Änd.-Datum:

24.01.2013

ITT
ASSEMBLY AND WIRING INSTRUCTION
MS / CA-BAYONET
 Circular Connector

CAS25094E

6



- Place wired contact into insertion tool in a way that contact, wire and insertion tool are axial to each other. Use the correct insertion tool (see 4.3).
- Insert contacts by applying slow, continuous pressure, until it snaps into its position.
- Do not install damaged or bent contacts! If a contact is damaged during the insertion this contact has to be removed. A new contact has to be installed.

7



- After insertion operation remove the insertion tool cautiously.
- Avoid any movement of the tool during the insertion process which is not axial to the contact / insulator.
- The picture shows fully assembled contacts.

Bearbeitet:

AKU

Geprüft:

BR/FA

Norm:

Änd.-Stand:

A 4411W

Änd.-Datum:

24.01.2013



ITT

ASSEMBLY AND WIRING INSTRUCTION

MS / CA-BAYONET
Circular Connector

CAS25094E



8

- After insertion of contacts remove the guide pins if necessary (socket contacts only).



- After insertion of the contacts, check the connector on the mating side to ensure that all contacts are on the same level.

8 Assembly Instruction for the Endbell Style M



1

- Move endbell to the shell. Tighten endbell nut.
- Make sure that teeth are sliding into each other.

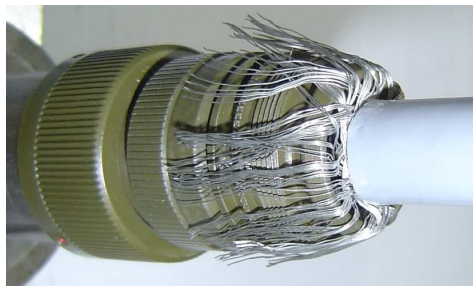

2

- Move the shielding braid on the endbell.
- Arrange it evenly round over the endbell.

Bearbeitet: AKU	Geprüft: BR/FA	Norm:	Änd.-Stand: A 4411W	Änd.-Datum: 24.01.2013
--------------------	-------------------	-------	------------------------	---------------------------



ASSEMBLY AND WIRING INSTRUCTION

MS / CA-BAYONET
Circular Connector

CAS25094E

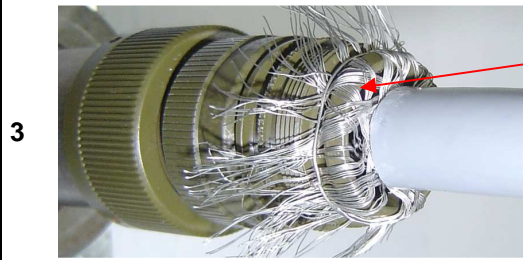

- Fix the shielding braid with binding wire.



- Cut the shielding braid according to picture, use a scissors or wire cutter.



- Move the clamping nut on the endbell.
- Screw the clamping nut to the endbell.

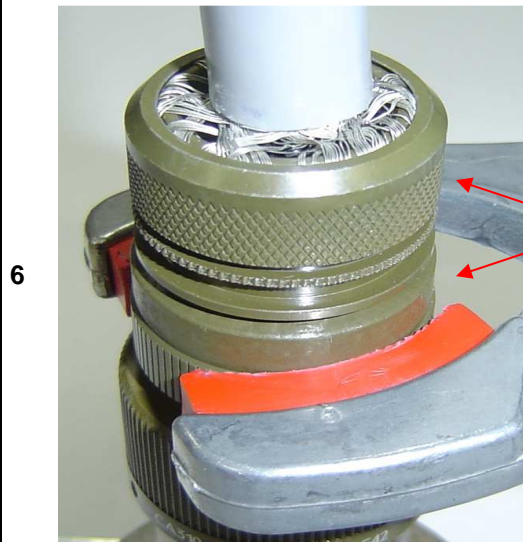

- Tighten the endbell housing and clamping nut .Note the permitted torque of endbell housing. See Table1 page 20.
- While tightening the endbell, take care that the cable is secured against twisting.
- HINT: use the mounting adapter or flange shell.



- Fully assembled connector (Heat shrink boot has to be mounted).

Bearbeitet: AKU	Geprüft: BR/FA	Norm:	Änd.-Stand: A 4411W	Änd.-Datum: 24.01.2013
--------------------	-------------------	-------	------------------------	---------------------------



ITT

ASSEMBLY AND WIRING INSTRUCTION

MS / CA-BAYONET

Circular Connector

CAS25094E

shell size	ENDBELL HOUSING clamping torque
8	4,0±0,5 Nm
10	6,0±0,5 Nm
12	8,0±1,0 Nm
14	10,0±1,0 Nm
16	10,0±1,0 Nm
18	13,0±1,0 Nm
20	13,0±1,0 Nm
22	13,0±1,0 Nm
24	13,0±1,0 Nm
26	13,0±1,0 Nm

Table1: permitted clamping torque of endbell housing

Thread	Torque for screws at the flanges Max. admissible torque
M3	1,2±0,2 Nm
M4	1,4±0,2 Nm
M5	2,0±0,2 Nm

8



- To finalize the assembly process a heat shrink boot has to be mounted to the connector endbell and the cable jacked.
- Heat shrinkable boots have to be purchased separately.

Bearbeitet: AKU	Geprüft: BR/FA	Norm:	Änd.-Stand: A 4411W	Änd.-Datum: 24.01.2013
--------------------	-------------------	-------	------------------------	---------------------------



ITT

ASSEMBLY AND WIRING INSTRUCTION

MS / CA-BAYONET
Circular Connector

CAS25094E

Straight Plug connector

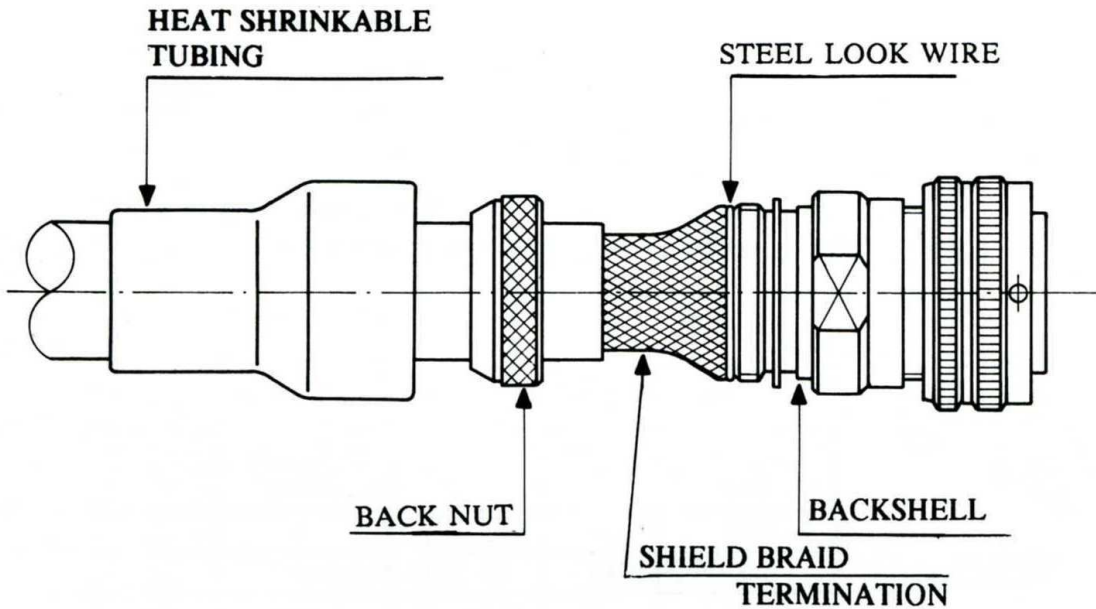

Straight Receptacle connector

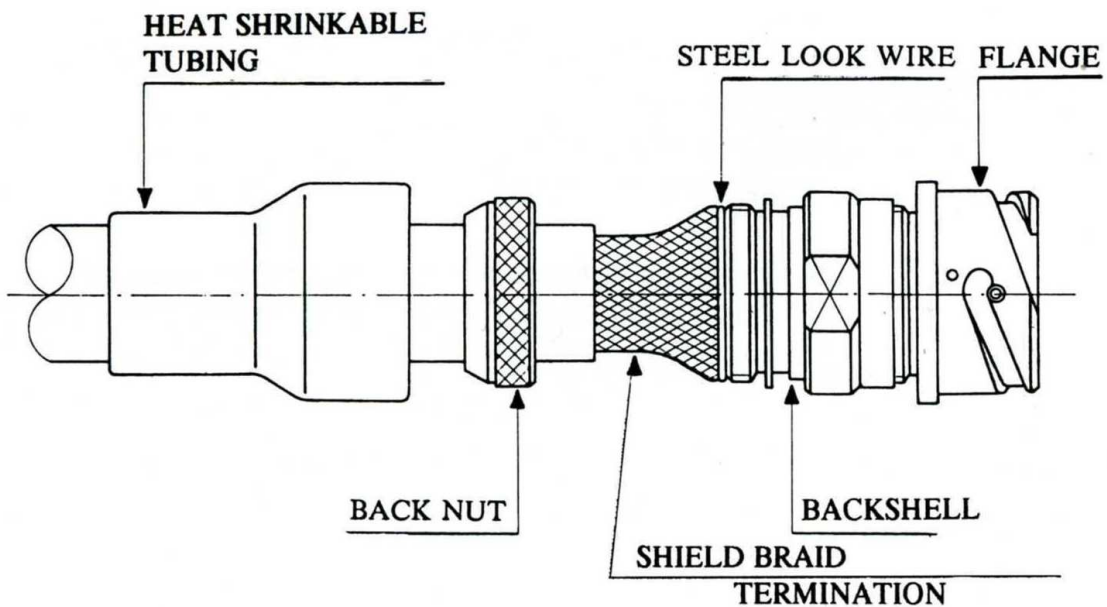

Bearbeitet:

AKU

Geprüft:

BR/FA

Norm:

Änd.-Stand:

A 4411W

Änd.-Datum:

24.01.2013

ITT
ASSEMBLY AND WIRING INSTRUCTION
MS / CA-BAYONET
 Circular Connector

CAS25094E

9 Removal of Contacts

1. All accessories are removed in reversed direction as described in "inserting contacts"
2. Use the correct removal tool as described on page 11.
3. Place tool from the mating side parallel to their axis over the socket or pin contact. Apply smooth and continuous pressure toward the rear end of the connector to push contact out of the insulator. The operation is terminated as soon as the shoulder of the tool butts against the front of the insulator.
4. Pull tool carefully out of the connector.



Extraction tools

Bearbeitet:

AKU

Geprüft:

BR/FA

Norm:

Änd.-Stand:

A 4411W

Änd.-Datum:

24.01.2013

	ASSEMBLY AND WIRING INSTRUCTION MS / CA-BAYONET Circular Connector	CAS25094E
---	---	------------------

10 Annex

10.0 Useful Hints

Keep hands, working place and connectors clean and free of any grease.

Check tools, connectors, accessories, cable sizes and other aids for correct part number and size.

Cable/wire cutting and stripping

Cut wire/cable in a way that a proper and even surface is achieved. Avoid indents, marks, or similar in the cutting area. During stripping of individual wires observe the stripping length depending on a contact size.

Prevent any damage of individual strands.

For solder connections pre-tin the conductor over the complete stripping length.

Keep time of soldering the conductors to contacts already installed in the insulator as short as possible in order to prevent any damage to the insulator which may be caused by over-heating.

To obtain good crimp connections please follow the rules:

- a) Use correct crimp tool with correct locator
- b) When terminating contacts sizes 60/100, 160 and 500 with the hydraulic crimp tool finalize crimping operations without interruption
- c) Use correct insertion tool for individual contacts
- d) Stripped conductors have to be crimped in a proper way.

The following simple tests can be made:

Visual:

Contacts are damaged during crimping (torn, bent, etc.) All wire strands must be inserted on the contact.

Mechanical:

Pull the terminated wire to check if crimp connection is properly made.

Insert contacts straight into insulator

Do not insert damage contacts

Maintain steady pressure when contacts are inserted

Do not use damaged insulators or grommets

Before insertion of wired contacts, slide hardware (grommet, endbell or cable clamp etc.) in proper order over the wire bundle. Please assure that the correct conductor is inserted into the correct cavity of the grommet.

Isopropyl alcohol facilitates insertion of cable into grommet.

Apply Isopropyl alcohol to the appropriate insulator cavity prior to insertion of contact.

Inspect visually, if all socket or pin contacts are inserted properly, i.e. whether the mating ends of the contacts are all on same level.

Mate shells resp. barrels with coupling nuts in correct assembly adapter.

Do not harness without using assembly adapters or mating connectors.

If required, lock endbell with Loctite or other locking compound. Loctite is to be stored at room temperature preferably below 20°C.

Insert contacts from the rear and release them from the mating face of the connector.

Extract contact only with the correct tool.

Note: according to weight and tension (vibration, acceleration) the cable has to be seized and fixed at the suitable place.

Bearbeitet: AKU	Geprüft: BR/FA	Norm: 	Änd.-Stand: A 4411W	Änd.-Datum: 24.01.2013
---------------------------	--------------------------	-----------	-------------------------------	----------------------------------



ITT

ASSEMBLY AND WIRING INSTRUCTION

MS / CA-BAYONET
Circular Connector

CAS25094E

10.1 Product Safety Information

1. MATERIAL CONTENT AND PHYSICAL FORM

Electrical connectors do not usually contain hazardous materials. They contain conducting and non-conducting materials and can be divided into two groups.

- a) Printed circuit types and low cost audio types which employ all plastic insulators and casings.
- b) Rugged, Fire Barrier and High Reliability types with metal casings and either natural rubber, synthetic rubber, plastic or glass insulating materials. Contact materials vary with type of connector and also application and are usually manufactured from either: Copper, copper alloys, nickel, alumel, chromel or steel. In special applications, other alloys may be specified.

2. FIRE CHARACTERISTICS AND ELECTRIC SHOCK HAZARD

There is no fire hazard when the connector is correctly wired and used within the specified parameters. Incorrect wiring or assembly of the connector or careless use of metal tools or conductive fluids, or transit damage to any of the component parts may cause electric shock or burns. Live circuits must not be broken by separating mated connectors as this may cause arcing, ionization and burning. Heat dissipation is greater at maximum resistance in a circuit. Hot spots may occur when resistance is raised locally by damage, e.g. cracked or deformed contacts, broken strands of wire. Local overheating may also result from the use of the incorrect application tools or from poor quality soldering or slack screw terminals. Overheating may occur if the ratings in the product Data Sheet/Catalog are exceeded and can cause breakdown of insulation and hence electric shock. If heating is allowed to continue it intensifies by further increasing the local resistance through loss of temper of spring contacts, formation of oxide film on contacts and wires and leakage currents through carbonization of insulation and tracking paths. Fire can then result in the presence of combustible materials and this may release noxious fumes. Overheating may not be visually apparent. Burns may result from touching overheated components.

3. HANDLING

Care must be taken to avoid damage to any component parts of electrical connectors during installation and use. Although there are normally no sharp edges, care must be taken when handling certain components to avoid injury to fingers. Electrical connectors may be damaged in transit to the customers, and damage may result in creation of hazards. Products should therefore be examined prior to installation/use and rejected if found to be damaged.

4. DISPOSAL

Incineration of certain materials may release noxious or even toxic fumes.

5. APPLICATION

Connectors with exposed contacts should not be selected for use on the current supply side of an electrical circuit, because an electric shock could result from touching exposed contacts on an unmated connector. Voltages in excess of 30 V ac or 42.5 V dc are potentially hazardous and care should be taken to ensure that such voltages cannot be transmitted in any way to exposed metal parts of the connector body. The connector and wiring should be checked, before making live, to have no damage to metal parts or insulators, no solder blobs, loose strands, conducting lubricants, swarf, or any other undesired conducting particles. Circuit resistance and continuity check should be made to make certain that there are no high resistance joints or spurious conducting paths. Always use the correct application tools as specified in the Data Sheet/Catalog. Do not permit untrained personnel to wire, assemble or tamper with connectors. For operation voltage please see appropriate national regulations.

IMPORTANT GENERAL INFORMATION

(i) Air and creepage paths/Operating voltage:

The admissible operating voltages depend on the individual applications and the valid national and other applicable safety regulations. For this reason the air and creepage path data are only reference values. Observe reduction of air and creepage paths due to PC board and/or harnessing.

(ii) Temperature:

All information given are temperature limits. The operation temperature depends on the individual application.

(iii) Other important information:

Cannon continuously endeavors to improve their products. Therefore, Cannon products may deviate from the description, technical data and shape as shown in this assembly and wiring instruction. ITT Interconnect Solutions, a Division of ITT Corporation manufactures the highest quality products available in the marketplace; however these products are intended to be used in accordance with the specifications in this publication. Any use or application that deviates from the stated operating specifications is not recommended and may be unsafe. No information and data contained in this publication shall be construed to create any liability on the part of Cannon. Any new issue of this publication shall automatically invalidate and supersede any and all previous issues.

Bearbeitet: AKU	Geprüft: BR/FA	Norm:	Änd.-Stand: A 4411W	Änd.-Datum: 24.01.2013
--------------------	-------------------	-------	------------------------	---------------------------