

NON-ISOLATED DC/DC CONVERTERS

4.5 Vdc – 13.2 Vdc Input 0.6 Vdc – 2.0 Vdc/30 A Output



May 17, 2016

Bel Power Inc., a subsidiary of Bel Fuse Inc.

SRPE-30E1A0 RoHS Compliant Rev.N

Features

- Non-Isolated
- Fixed frequency
- High efficiency
- High Power Density
- Overtemperature Shutdown
- Wide Input Voltage Range
- Low Cost
- Wide Operating Temperature Range (0 °C - 50 °C)
- Class 2, Category 2, Non-Isolated DC/DC Converter (refer to IPC-9592B)
- Wide Output Trim Range
- Output Over-Voltage Shutdown
- OCP/SCP
- Power Good Signal
- Remote Sense
- Remote On/Off
- Undervoltage lockout

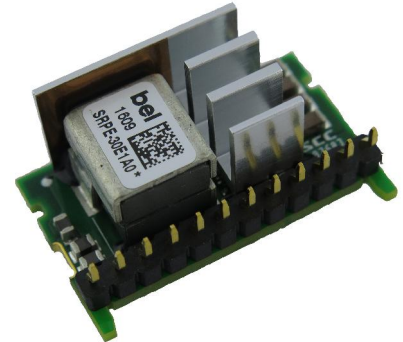

Applications

- Networking
- Computers and peripherals
- Telecommunications

Description

The Bel SRPE-30E1A0 is part of the non-isolated dc to dc converter Power Module series. The modules use a Vertical SMT package. These converters are available in a range of output voltages from 0.6 Vdc to 2.0 Vdc over a wide range of input voltage ($V_{in} = 4.5 - 13.2$ Vdc).

Part Selection

Output Voltage	Input Voltage	Max. Output Current	Max. Output Power	Typical Efficiency	Model Number Active High
0.6 Vdc – 2.0 Vdc	4.5 Vdc - 13.2 Vdc	30 A	60 W	91.5%	SRPE-30E1A0

Notes: 1. Add "G" suffix at the end of the model numbers listed above to indicate "Tray Packaging".

Ordering Part Number

S R PE - 30 E 1A 0 X
1 2 3 4 5 6 7 8

- 1---Mounting type,
- 2---RoHS Status,
- 3---Series name,
- 4---Output power,
- 5---Input range,
- 6---Output voltage,
- 7---Active logic and HSK feature,
- 8---Package type,

- S –Surface mount
- R – RoHS 6
- PE –SMD Series name
- 30 – 30A output
- E – 4.5-13.2V input
- 1A – 0.6-2.0V output
- 0 – active high, with HSK
- G – Tray packaging

NON-ISOLATED DC/DC CONVERTERS

4.5 Vdc – 13.2 Vdc Input 0.6 Vdc – 2.0 Vdc/30 A Output



May 17, 2016

Bel Power Inc., a subsidiary of Bel Fuse Inc.

Absolute Maximum Ratings

Parameter	Min	Typ	Max	Unit	Notes
Continuous non-operating Input Voltage	-0.3	-	15	V	
Output Enable Terminal Voltage	-0.3	-	15	V	
Ambient Temperature	0	-	50	°C	
Storage Temperature	-40	-	125	°C	
Altitude	-	-	2000	m	

Note: Ratings used beyond the maximum ratings may cause a reliability degradation of the converter or may permanently damage the device.

Input Specifications

Parameter	Min	Typ	Max	Unit	Notes
Input Voltage	4.5	12	13.2	V	
Input Current (full load)	-	-	15.0	A	
Input Current (no load)	-	20	35	mA	All Vin, Vout=0.6V, At Ta=25C.
	-	35	50	mA	All Vin, Vout=1.2V, At Ta=25C.
	-	45	70	mA	All Vin, Vout=2V, At Ta=25C.
Remote Off Input Current	-	15	-	mA	
Input Reflected Ripple Current (rms)	-	-	30	mA	Vout = 2V, Iout = 30A. With simulated source impedance of 1uH, 5Hz to 20MHz. Use a 100uF/100V electrolytic capacitors with ESR < 0.2ohm max @ 25C.
Input Reflected Ripple Current (pk-pk)	-	-	100	mA	
Turn-on Voltage Threshold	3.8	4.3	5	V	Ta=20C-50C
	7	8	9	V	The turn on voltage should not be less than 7V when Ta=0C-20C.
Turn-off Voltage Threshold	3.8	4.1	4.5	V	

Note: All specifications are typical at 25 °C unless otherwise stated.

Output Specifications

Parameter	Min	Typ	Max	Unit	Notes	
Output Voltage Set Point	Vo,set ≥ 0.9Vdc	-2	-	2	%Vo,set	Setpoint test condition: Vin=12V, Iout=half load, Ta=25°C
	Vo,set < 0.9Vdc	-3	-	3	%Vo,set	
Load regulation	-2	-	2	%Vo,set	Vin=12V, Io=0-30A, Ta=25°C	
Line Regulation	-2	-	2	%Vo,set	Vin=4.5-13.2V, Io=30A, Ta=25°C	
Regulation Over Temperature	-	±3	-	%Vo,set		
Output Ripple and Noise (pk-pk)	-	-	30	mV	Condition: Vin=12V, Iout=full load, Ta=25°C, measured with a 10uF+7*100uF ceramic cap and 3*470uF POSCAP ESR ≤ 12mohm at output.	
Output Ripple and Noise (rms)	-	-	5	mV		
Output Current Range	0	-	30	A		
Output DC Current Limit	33	-	48	A		

NON-ISOLATED DC/DC CONVERTERS

4.5 Vdc – 13.2 Vdc Input 0.6 Vdc – 2.0 Vdc/30 A Output



May 17, 2016

Bel Power Inc., a subsidiary of Bel Fuse Inc.

Output Specifications (continued)

Parameter	Min	Typ	Max	Unit	Notes	
Turn On Time	-	-	5	ms		
Overshoot at Turn on	-	0	5	%		
Output Capacitance	470	-	9000	uF	Required Cout min = 470uF with ESR <= 12mohm.	
Transient Response						
ΔV 50%~75% of Max Load	Overshoot	-	40	60	mV	Vin=12V, Vout=2.0V, di/dt=2.5A/us. Measured with a 10uF+7*100uF ceramic cap and 3*470uF POSCAP ESR <= 12mohm at output.
	Settling Time	-	20	50	us	
ΔV 75%~50% of Max Load	Overshoot	-	40	60	mV	
	Settling Time	-	20	50	us	

Note: All specifications are typical at 25°C unless otherwise stated.

General Specifications

Parameter	Min	Typ	Max	Unit	Notes
Efficiency Vo=0.6V, TA=25C	79	80	-	%	
	86	87.7	-	%	
	90	91.5	-	%	
Switching Frequency	-	500	-	kHz	
Over Temperature Protection	-	125	-	°C	
Output Voltage Trim Range(Wide Trim)	0.6	-	2	V	This voltage is achieved by trimming up output slowly.
Weight	-	10.4	-	g	
MTBF	-	71.7	-	Mhrs	Calculated Per Telcordia SR-332, Issue 3 (Vin=12V, Vo=0.9V, Io=30A, Ta=40C, with 300 LFM, FIT=10 ⁹ /MTBF)
FIT	-	13.9	-	-	
Dimensions Inches (L x W x H) Millimeters (L x W x H)	1.20 x 0.65 x 0.59 30.48 x 16.51 x 15.00			-	

Note: All specifications are typical at 25 °C unless otherwise stated.

Control Specifications

Parameter	Min	Typ	Max	Unit	Notes
Remote On/Off					
Signal Low(Unit Off)	0	-	0.5	V	Remote On/Off pin open, unit off.
Signal High(Unit On)	1.8	-	15	V	

NON-ISOLATED DC/DC CONVERTERS

4.5 Vdc – 13.2 Vdc Input 0.6 Vdc – 2.0 Vdc/30 A Output



May 17, 2016

Bel Power Inc., a subsidiary of Bel Fuse Inc.

Efficiency Data

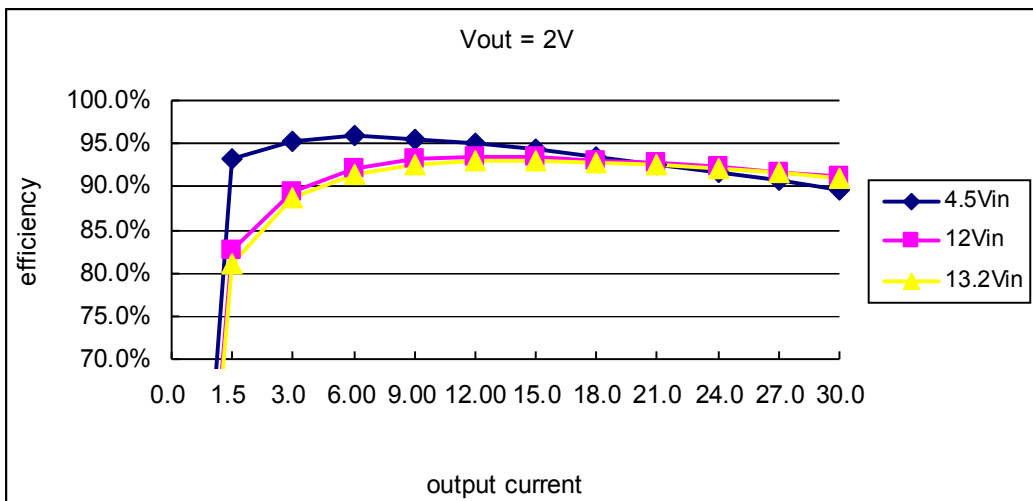
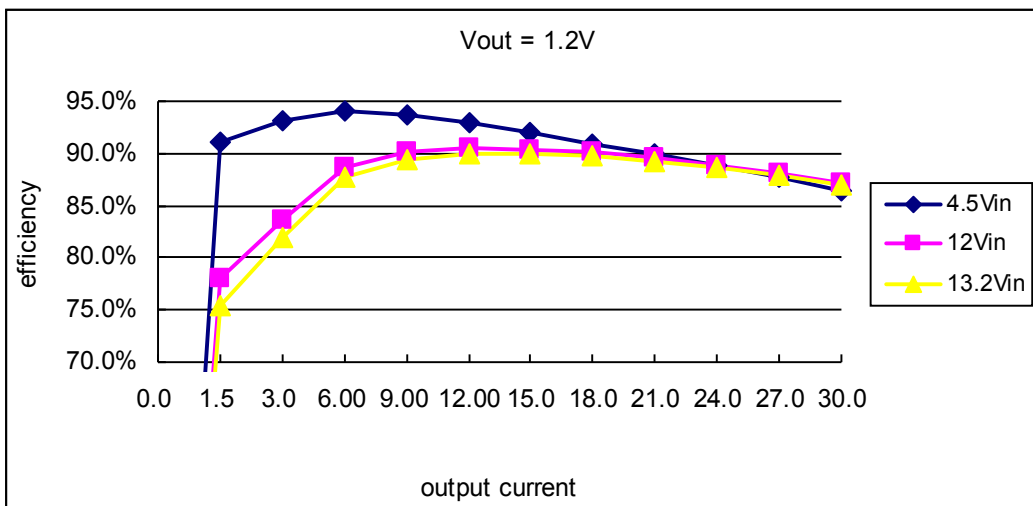
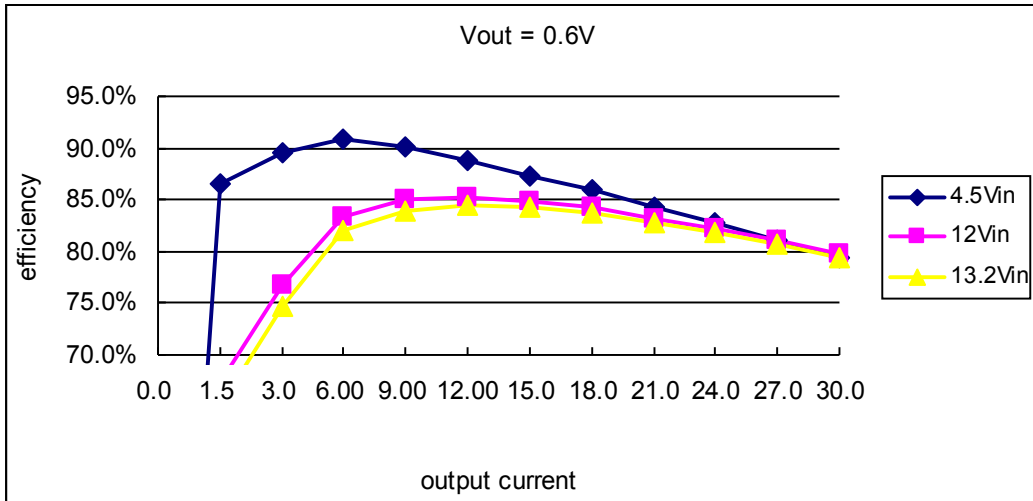

NON-ISOLATED DC/DC CONVERTERS

4.5 Vdc – 13.2 Vdc Input 0.6 Vdc – 2.0 Vdc/30 A Output



May 17, 2016

Bel Power Inc., a subsidiary of Bel Fuse Inc.

Input Noise

Input reflected ripple current

Testing setup

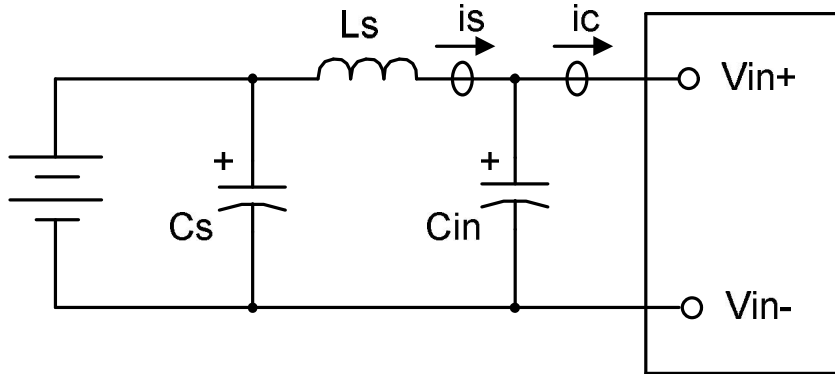

Notes and values in testing.

is: Input Reflected Ripple Current

ic: Input Terminal Ripple Current

Ls: Simulated Source Impedance (1 μ H)

Cs: Offset possible source Impedance (100 μ F, ESR<0.2 Ω @ 100kHz, 20C)

Cin: Electrolytic capacitor, should be as closed as possible to the power module to swallow ic ripple current and help with stability. Recommendation: 100 μ F, ESR<0.2 Ω @ 100kHz, 20C.

Below measured waveforms are based on above simulated and recommended inductance and capacitance.

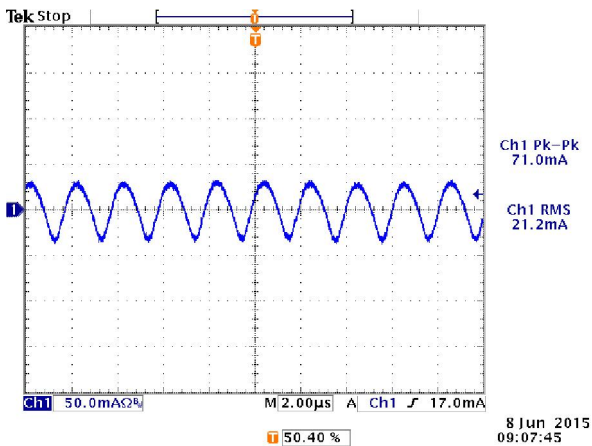

is (input reflected ripple current), AC component

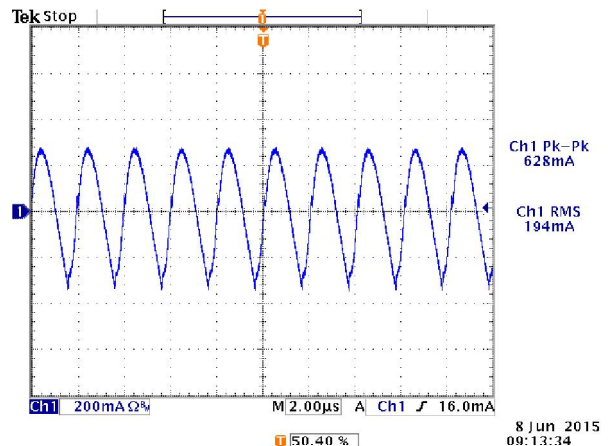

ic (input terminal ripple current), AC component

Note: Vin=12V,Vo=2V,Io=30A,with 1*10 μ F ceramic and 1*470 μ F polymer capacitor at the output, Ta=25 deg C.

NON-ISOLATED DC/DC CONVERTERS

4.5 Vdc – 13.2 Vdc Input 0.6 Vdc – 2.0 Vdc/30 A Output



May 17, 2016

Bel Power Inc., a subsidiary of Bel Fuse Inc.

Thermal Derating Curves

Hot spot location and allowed maximum temperature

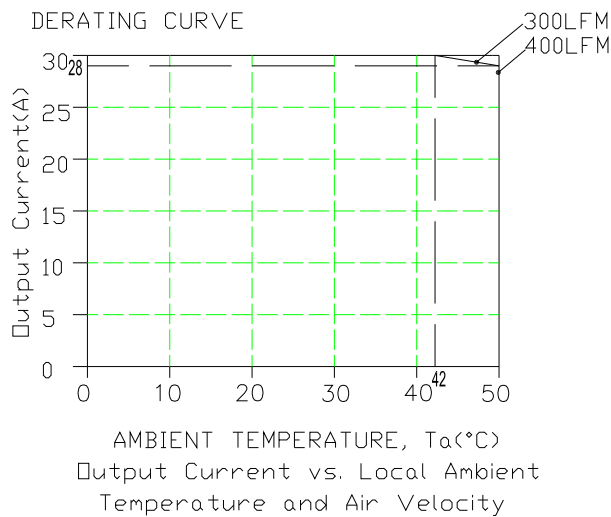
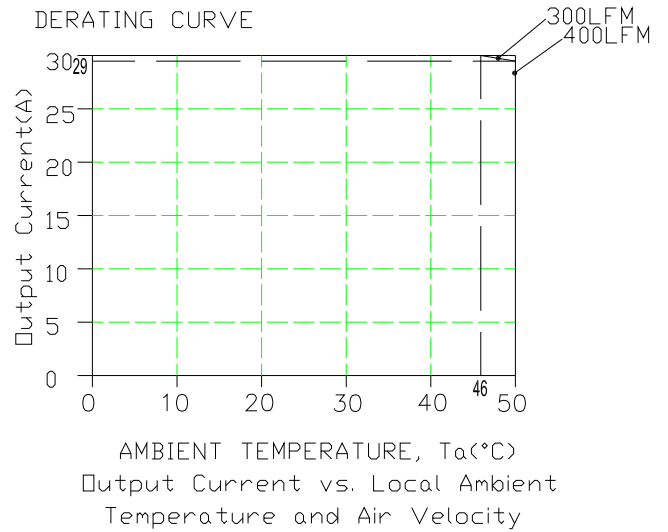
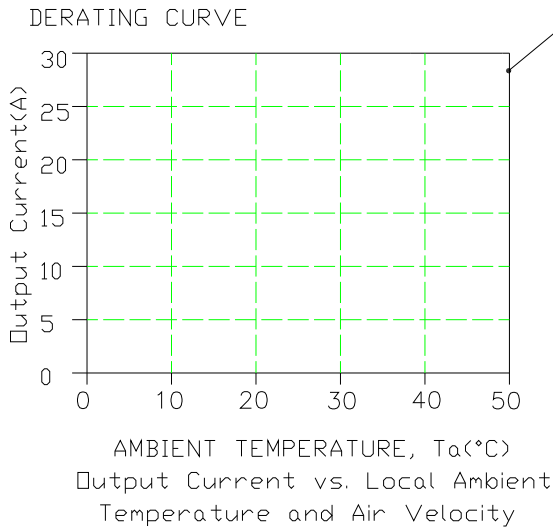
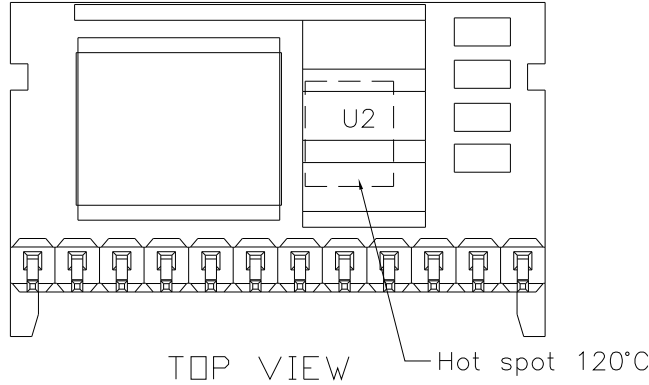

NON-ISOLATED DC/DC CONVERTERS

4.5 Vdc – 13.2 Vdc Input 0.6 Vdc – 2.0 Vdc/30 A Output



May 17, 2016

Bel Power Inc., a subsidiary of Bel Fuse Inc.

Input under-voltage lockout

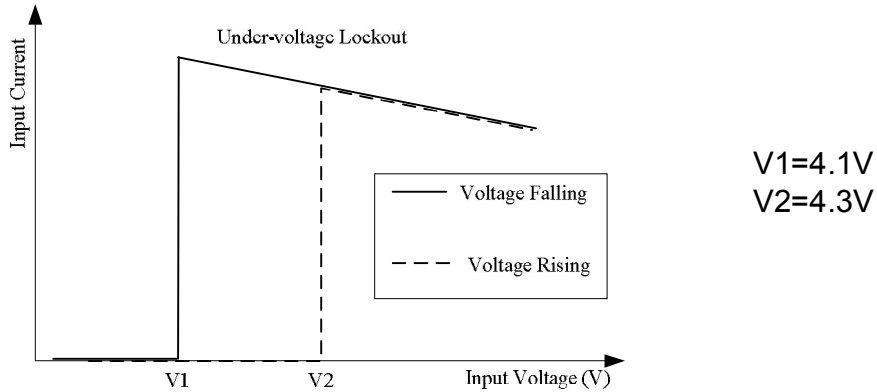

Ripple and Noise Waveform

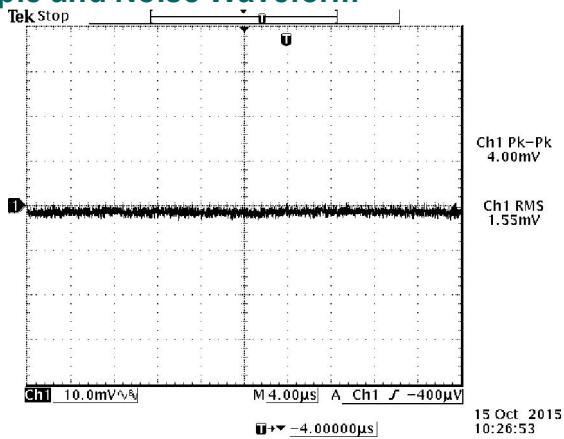

Ripple and noise at full load, 12Vdc input
0.6Vdc/30A output and Ta=25 deg C

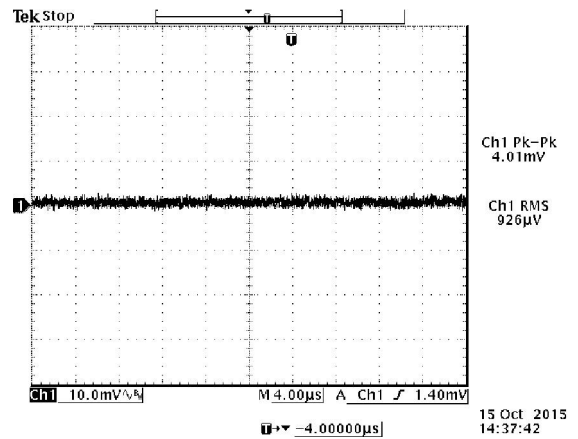

Ripple and noise at full load, 12Vdc input
0.9Vdc/30A output and Ta=25 deg C

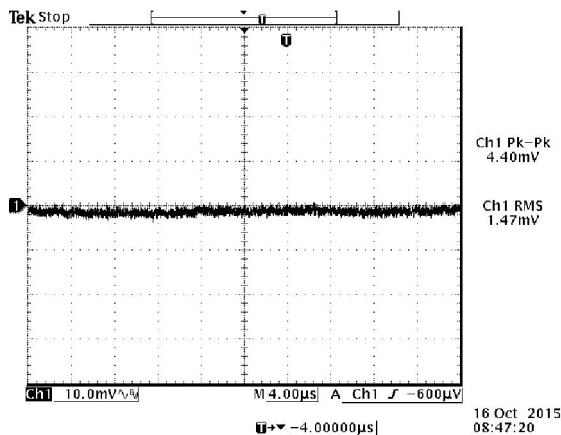

Ripple and noise at full load, 12Vdc input, 2.0Vdc/30A output and Ta=25 deg C

Note:

Test condition of the output ripple and noise:

0-20MHz BW, with a 10uF+7*100uF ceramic cap and 3*470uF POSCAP ESR <= 12mohm at output.

NON-ISOLATED DC/DC CONVERTERS

4.5 Vdc – 13.2 Vdc Input 0.6 Vdc – 2.0 Vdc/30 A Output



May 17, 2016

Bel Power Inc., a subsidiary of Bel Fuse Inc.

Transient Response Waveforms

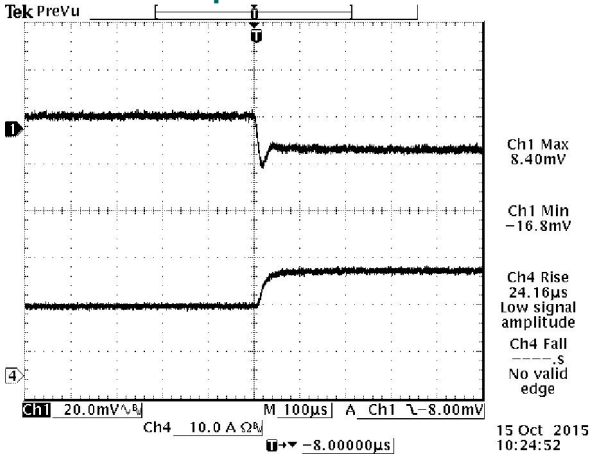

50%—75% Load Transient at Vin=12Vdc
Vout=0.6Vdc @Ta=25 deg C

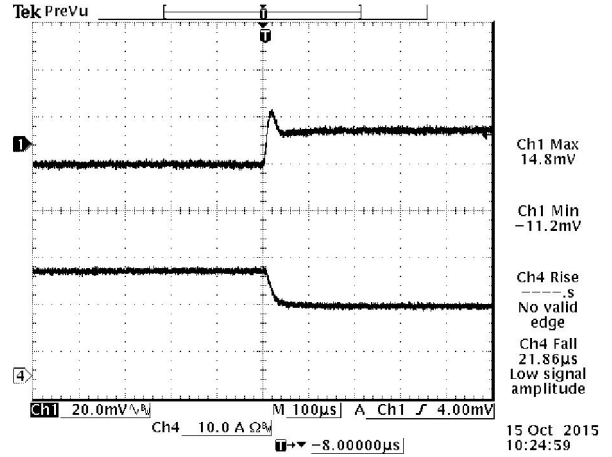

75%—50% Load Transient at Vin=12Vdc
Vout=0.6Vdc @Ta=25 deg C

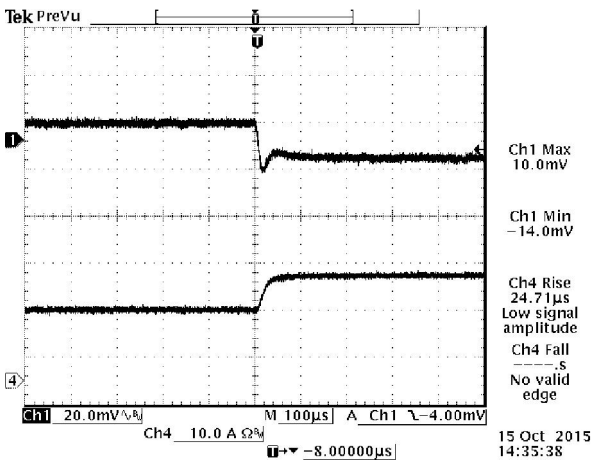

50%—75% Load Transient at Vin=12Vdc
Vout=0.9Vdc @Ta=25 deg C

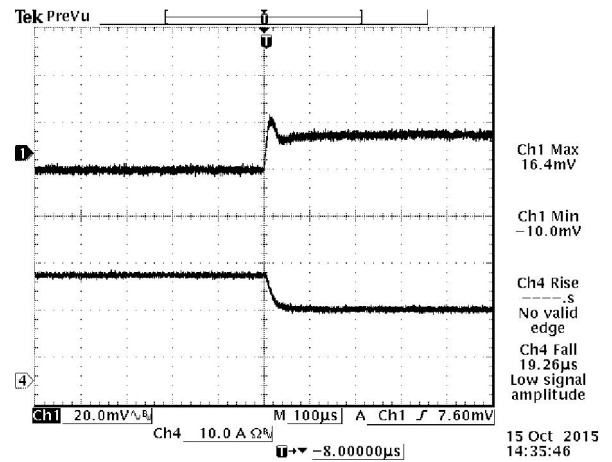

75%—50% Load Transient at Vin=12Vdc
Vout=0.9Vdc @Ta=25 deg C

NON-ISOLATED DC/DC CONVERTERS

4.5 Vdc – 13.2 Vdc Input 0.6 Vdc – 2.0 Vdc/30 A Output



May 17, 2016

Startup&Shutdown

Bel Power Inc., a subsidiary of Bel Fuse Inc.

Rise time

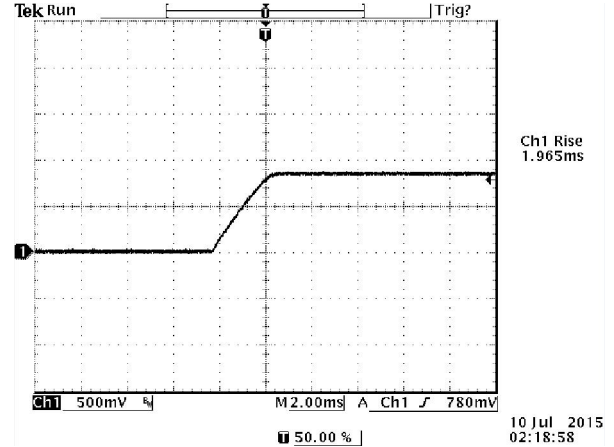
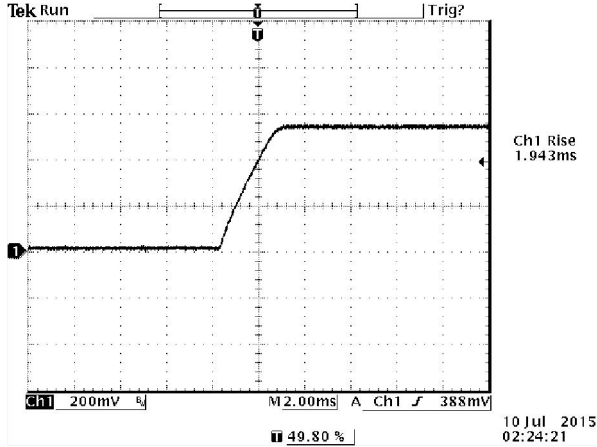

Rise time at full load, 12Vdc input
0.6Vdc/30A output and Ta=25 deg C

Rise time at full load, 12Vdc input
0.9Vdc/30A output and Ta=25 deg C

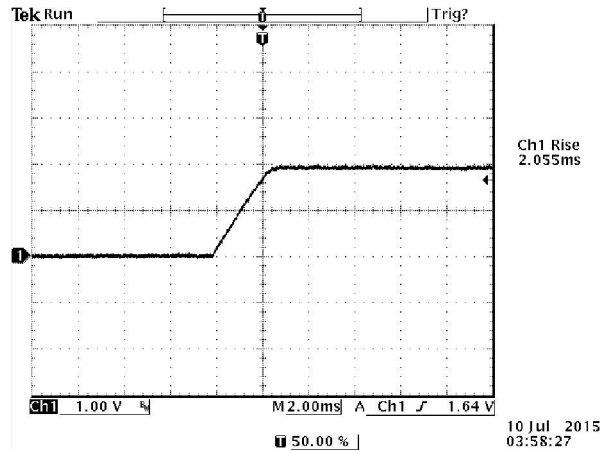

Rise time at full load, 12Vdc input, 2.0Vdc/30A output and Ta=25 deg C,

Note: Test condition of the Rise time: With a 10uF+7*100uF ceramic cap and 3*470uF POSCAP ESR <= 12mohm at output.

NON-ISOLATED DC/DC CONVERTERS

4.5 Vdc – 13.2 Vdc Input 0.6 Vdc – 2.0 Vdc/30 A Output



May 17, 2016

Bel Power Inc., a subsidiary of Bel Fuse Inc.

Startup&Shutdown(continued)

Startup time

Startup from remote on/off

Ch1: Vo

Ch3: remote on/off

Test Condition:

With a 10uF+7*100uF ceramic cap and 3*470uF POSCAP ESR <= 12mohm at output.

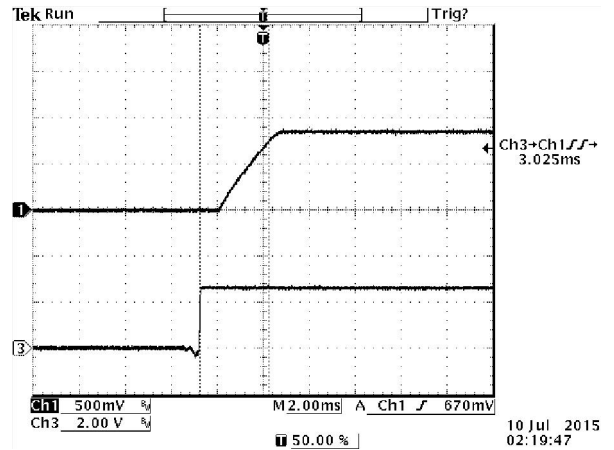
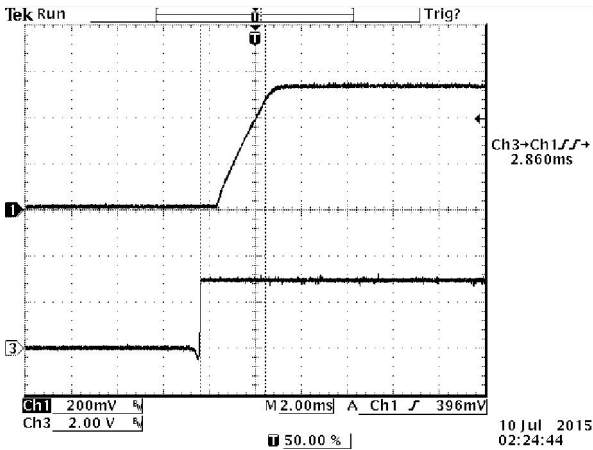

Start up time at full load, 12Vdc input
0.6Vdc/30A output and Ta=25 deg C

Start up time at full load, 12Vdc input
0.9Vdc/30A output and Ta=25 deg C

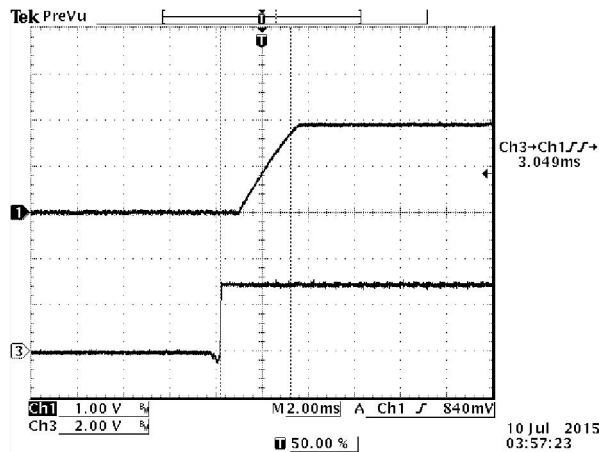

Start up time at full load, 12Vdc input, 2.0Vdc/30A output and Ta=25 deg C,

NON-ISOLATED DC/DC CONVERTERS

4.5 Vdc – 13.2 Vdc Input 0.6 Vdc – 2.0 Vdc/30 A Output



May 17, 2016

Bel Power Inc., a subsidiary of Bel Fuse Inc.

Trim

Output Voltage Set-Point Adjustment

Maximum trim up voltage is 2V.

Minimum trim up voltage is 0.6V.

1. Trim up circuit (using an external resistor)

Equations for calculating the trim resistor are shown below.

The Trim Up resistor should be connected between the Trim pin and the GND.

SRP1-30E1A0 Trim up Resistor Calculate Unit: K Ω

V_o is the desired output voltage

R_{trimup} is the required resistance between TRIM and GND

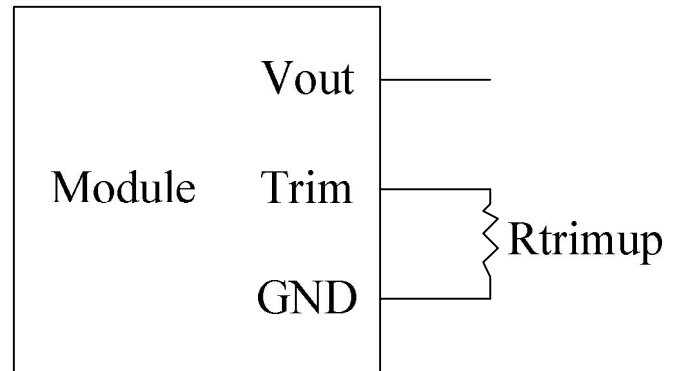
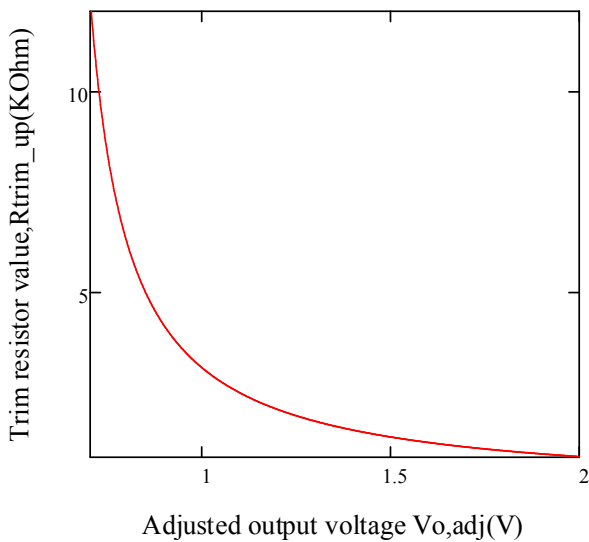

$$R_{trimup} = \frac{1.2}{V_o - 0.6}$$

NON-ISOLATED DC/DC CONVERTERS

4.5 Vdc – 13.2 Vdc Input 0.6 Vdc – 2.0 Vdc/30 A Output



May 17, 2016

Bel Power Inc., a subsidiary of Bel Fuse Inc.

Trim(continued)

2.Trim up circuit (using external PWM signal)

Equations for calculating the duty cycle are shown below.

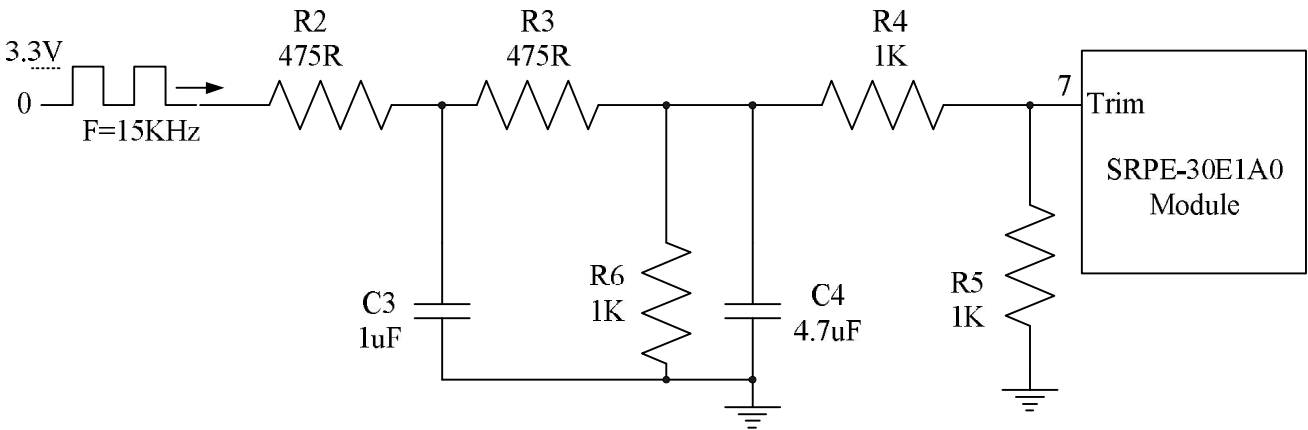

$$V_o(D) = 2.72 - 0.0234D$$

SRP1-30E1A0 Trim up duty cycle Calculate Unit: %

V_o is the desired output voltage

D is the external PWM signal duty cycle.

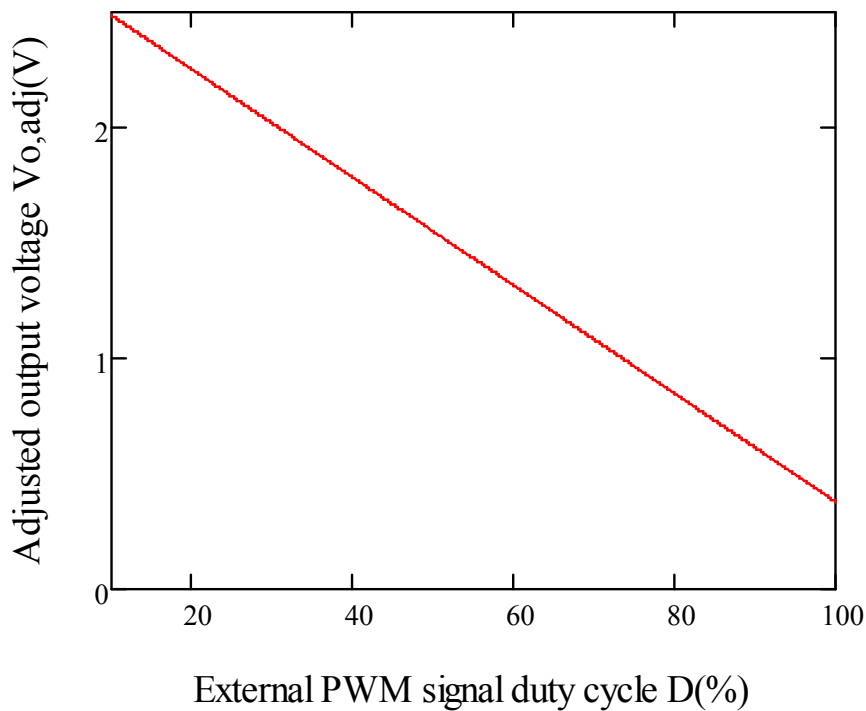

NON-ISOLATED DC/DC CONVERTERS

4.5 Vdc – 13.2 Vdc Input 0.6 Vdc – 2.0 Vdc/30 A Output



May 17, 2016

Bel Power Inc., a subsidiary of Bel Fuse Inc.

OCP

To provide protection in a fault output overload condition, the module is equipped with internal current-limiting circuitry and can endure current limiting for a few milli-seconds. If the overcurrent condition persists beyond a few milliseconds, the module will shut down into hiccup mode and restart once every 40mS. The module operates normally when the output current goes into specified range. The typical average output current is 4A during hiccup.

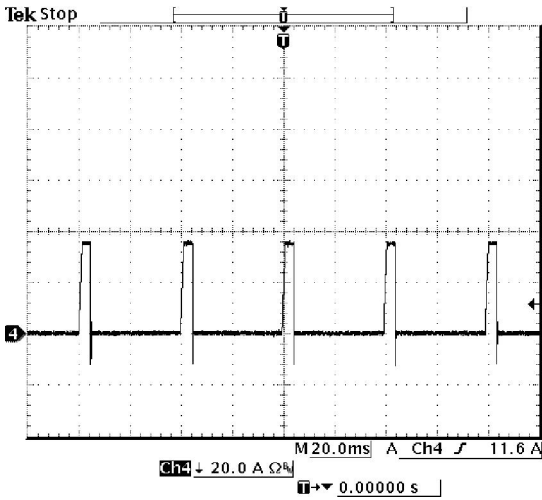

Output current @ SCP, $V_{in} = 12V$
 $V_{out} = 0.6V$, $T_a = 25 \text{ deg C}$

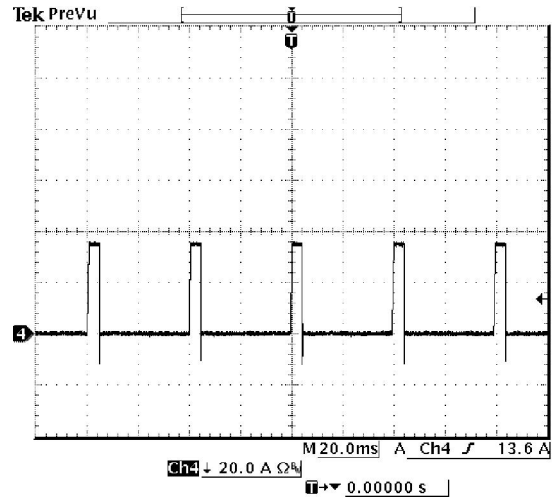

Output current @ SCP, $V_{in} = 12V$
 $V_{out} = 0.9V$, $T_a = 25 \text{ deg C}$

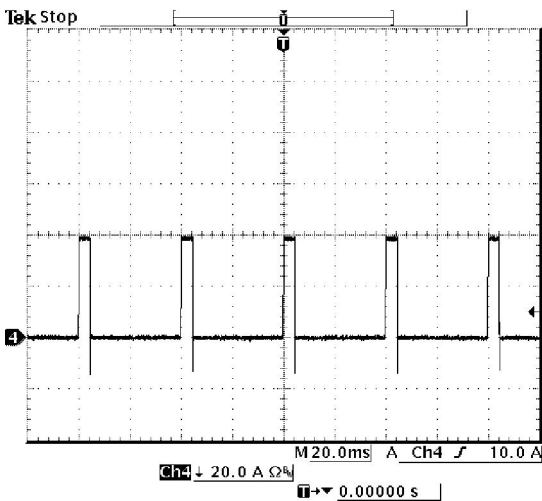

Output current @ SCP, $V_{in} = 12V$
 $V_{out} = 1.5V$, $T_a = 25 \text{ deg C}$

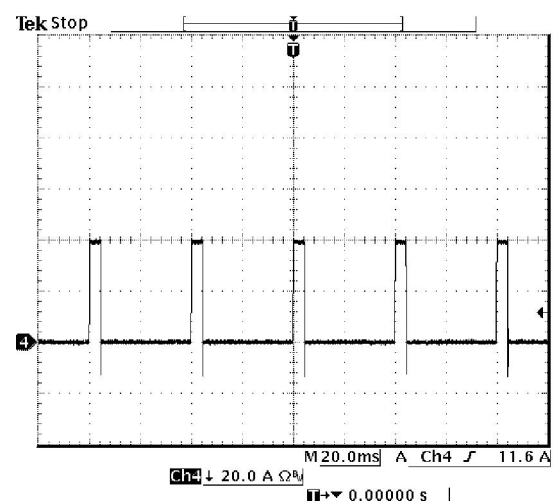

Output current @ SCP, $V_{in} = 12V$
 $V_{out} = 2.0V$, $T_a = 25 \text{ deg C}$

Note:

Test condition of SCP:

With a 10uF ceramic cap and a 470uF POSCAP ESR <= 12mohm at output.

NON-ISOLATED DC/DC CONVERTERS

4.5 Vdc – 13.2 Vdc Input 0.6 Vdc – 2.0 Vdc/30 A Output



May 17, 2016

Bel Power Inc., a subsidiary of Bel Fuse Inc.

Power Good

1. This module has a power good indicator output. Power good pin used positive logic and is open collector.
2. The maximum voltage pulled up externally on Power Good pin should not exceed 7V.
3. If the output voltage becomes within +10% and –5% of the target value, internal comparators detect power-good state and the power-good signal becomes high after a 1ms internal delay.
4. If the output voltage goes outside of +15% or –10% of the target value, the power-good signal becomes low after two microsecond (2- μ s) internal delay.
5. The pull up resistance must be larger than 10k ohm.

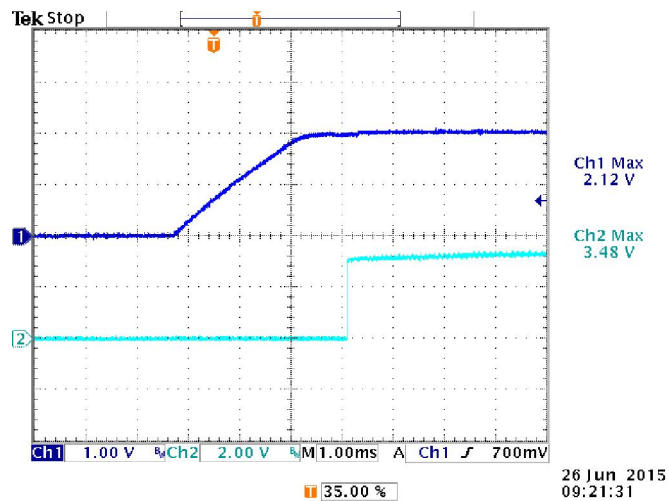

Typical Start-up using Remote on/off, $V_{in}=12V$, $V_o=2V$, $I_o=0A$
CH1=Vout CH2=PG

NON-ISOLATED DC/DC CONVERTERS

4.5 Vdc – 13.2 Vdc Input 0.6 Vdc – 2.0 Vdc/30 A Output



May 17, 2016

Bel Power Inc., a subsidiary of Bel Fuse Inc.

Soldering Information

The SRPE-30E1A0G modules are designed to be compatible with a Paste-In-Hole assembly process. The suggested Pb-free solder paste is Sn/Ag/Cu(SAC). The recommended reflow profile using Sn/Ag/Cu solder is shown in the following. Recommended reflow peak temperature is 245°C while the part can withstand peak temperature of 260°C maximum for 10seconds. This profile should be used only as a guideline. Many other factors influence the success of SMT reflow soldering. Since your production environment may differ, please thoroughly review these guidelines with your process engineers.

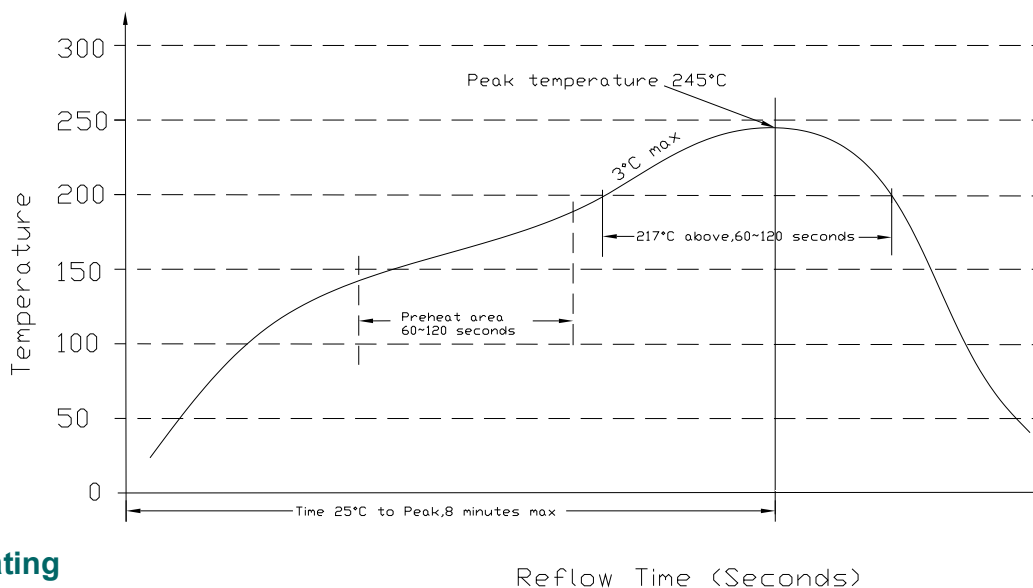

MSL Rating

The SRPE-30E1A0G modules have a MSL rating of 3.

Storage and Handling

The SRPE-30E1A0G modules are designed to be compatible with J-STD-033 Rev:A (Handling, Packing, Shipping and Use of Moisture /Reflow Sensitive surface Mount devices). Moisture barrier bags (MBB) with desiccant are applied. The recommended storage environment and handling procedure is detailed in J-STD-033.

Pre-baking

This component has been designed, handled, and packaged ready for pb-free reflow soldering. If the assembly shop follows J-STD-033 guidelines, no pre-bake of this component is required before being reflowed to a PCB. However, if the J-STD-033 guidelines are not followed by the assembler, Bel recommends that the modules should be pre-baked @ 120~125°C for a minimum of 4 hours (preferably 24 hours) before reflow soldering.

NON-ISOLATED DC/DC CONVERTERS

4.5 Vdc – 13.2 Vdc Input 0.6 Vdc – 2.0 Vdc/30 A Output



May 17, 2016

Bel Power Inc., a subsidiary of Bel Fuse Inc.

Mechanical Outline

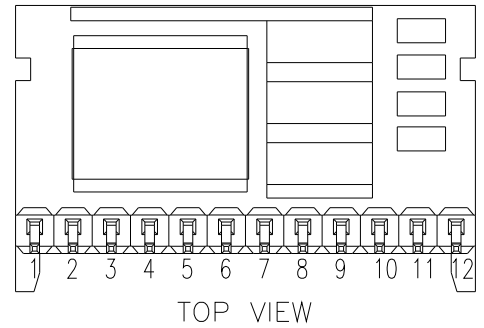
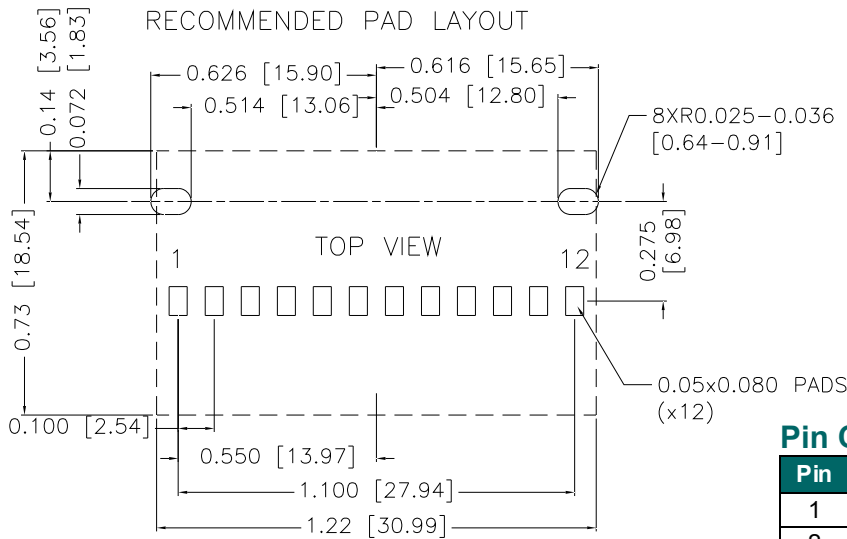
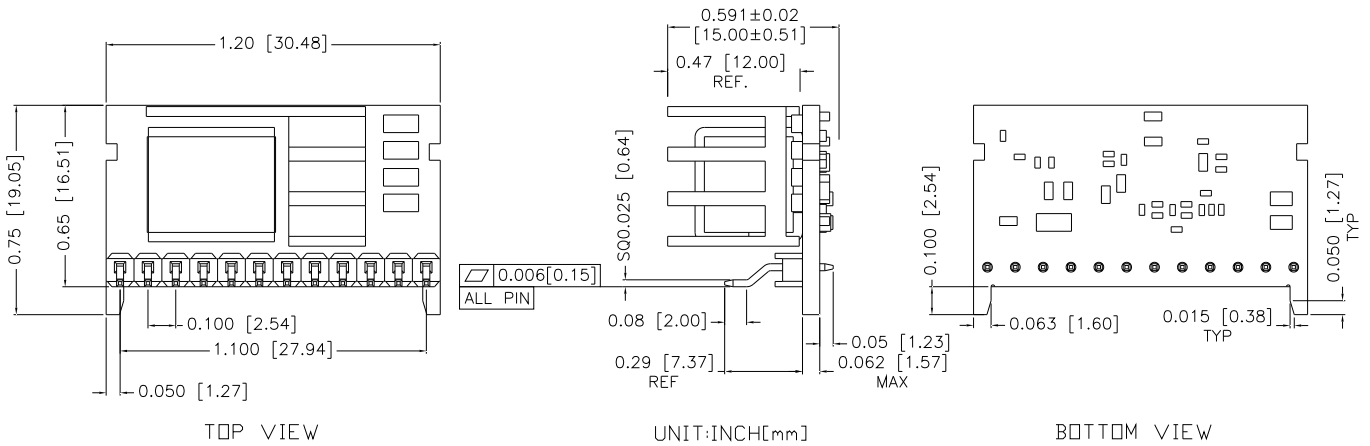

Pin Connections

Pin	Function	Pin	Function
1	Vout	7	Trim
2	Vout	8	PGOOD
3	Vout	9	Vsense+
4	GND	10	Vsense-
5	GND	11	GND
6	Enable	12	Vin

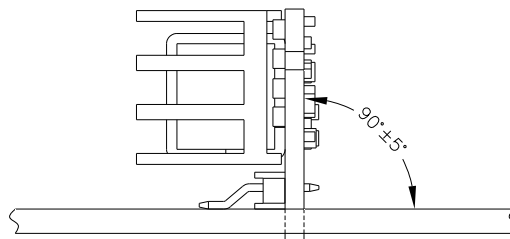
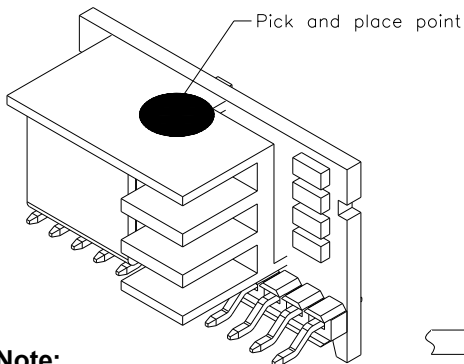

Note:

- 1) All Pins: Material - Copper Alloy;
Finish – 3 micro inches minimum Gold over 50 micro inches minimum Nickel plate.
- 2) Undimensioned components are shown for visual reference only.
- 3) All dimensions in inches (mm); Tolerances: x.xx +/-0.02 in [0.5mm]. x.xxx +/-0.010 in [0.25mm].

NON-ISOLATED DC/DC CONVERTERS

4.5 Vdc – 13.2 Vdc Input 0.6 Vdc – 2.0 Vdc/30 A Output



May 17, 2016

*Bel Power Inc., a subsidiary of Bel Fuse Inc.***Datasheet Revision History**

Date	Revision	Changes Detail	Approval
2013-08-19	PA	First release	Jessica
2013-10-10	PB	Update mechanical drawing	Jessica
2014-01-10	PC	Update input / output spec, efficiency and remote on/off.	Jessica
2014-4-14	PD	Update Output Specs, General, Efficiency Data, NR,TR, Startup&Shutdown, OCP	Jessica
2014-7-3	PE	Update part number explanation, RoHS compliance, Add MD Note.	Jessica
2014-7-11	PF	Update Cover, MD	Jessica
2014-7-29	G	Added assembly guide drawing	Jessica
2014-12-18	H	Added trim resistor equation	Jessica
2015-07-07	I	<p>Input specs :</p> <ol style="list-style-type: none"> 1. Change no load input current. 2. Change remoted off input current to 15mA. 3. Change input reflected ripple current (RMS) from 20mA to 30mA. 4. Update turn on voltage threshold: min value 3.8V, typical value 4.3V, max value 5V. 5. Update turn off voltage threshold: min value 3.8V, typical value 4.1V, max value 4.5V. <p>Output specs:</p> <ol style="list-style-type: none"> 1. Change output voltage set point max to 10%Vo. 2. Change the load/line regulation range as $\pm 5\%V_o$. 3. Change output ripple and noise max value to 30mV. 4. Update transient response. <p>General:</p> <ol style="list-style-type: none"> 1. Update the efficiency. Including efficiency data and graphs. 2. Update the weight of module. <p>Update the TD.</p> <p>Add the input noise.</p> <p>Add the PG signal section.</p> <p>Update mechanical drawing, change the thickness of module to 0.591 inch, change the thickness of heatsink to 0.47 inch.</p>	Jessica

NON-ISOLATED DC/DC CONVERTERS

4.5 Vdc – 13.2 Vdc Input 0.6 Vdc – 2.0 Vdc/30 A Output



May 17, 2016

Bel Power Inc., a subsidiary of Bel Fuse Inc.

Datasheet Revision History

Date	Revision	Changes Detail	Approval
2015-11-16	J	Output specs : Shrink the output voltage set point, line regulation, load regulation range. Update the waveform of ripple and noise/transient response/Startup&Shutdown. Add tilt dimension in mechanical drawing, update recommended pad layout.	Jessica
2016-01-05	K	Output specs : Shrink the output voltage set point, line regulation, load regulation range.	Jessica
2016-01-22	L	Update MTBF, FIT.	Jessica
2016-02-2	M	Input specs: Update the turn on voltage information.	Jessica
2016-05-17	N	Add hot spot location.	Jessica

RoHS Compliance

Complies with the European Directive 2011/65/EU, calling for the elimination of lead and other hazardous substances from electronic products.



©2016 Bel Fuse Inc. Specifications subject to change without notice. 051716

19

CORPORATE

Bel Fuse Inc.
206 Van Vorst Street
Jersey City, NJ 07302
Tel 201-432-0463
Fax 201-432-9542
www.belfuse.com

FAR EAST

Bel Fuse Ltd.
8F/ 8 Luk Hop Street
San Po Kong
Kowloon, Hong Kong
Tel 852-2328-5515
Fax 852-2352-3706
www.belfuse.com

EUROPE

Bel Fuse Europe Ltd.
Preston Technology Management Centre
Marsh Lane, Suite G7, Preston
Lancashire, PR1 8UD, U.K.
Tel 44-1772-556601
Fax 44-1772-888366
www.belfuse.com