

Printed Circuit Board Mount Power Film Capacitors

C4AQ Miniaturized, Radial, 2 or 4 Leads, 500 – 1,200 VDC, for DC Link (Automotive Grade)

KEMET
 a YAGEO company

Overview

The C4AQ M capacitor is a miniaturized polypropylene metallized film capacitor with a rectangular, plastic box-type design, filled with resin, and uses 2 or 4 tinned wires.

Automotive grade devices meet the demanding Automotive Electronics Council's AEC-Q200 qualification requirements.

Applications

Typical applications include DC filtering, DC link, power electronics, energy storage, renewable energy grid interface, motor drives, and automotive applications.

Benefits

- Miniaturized Sizes
- Maximum Temperature: 125°C (passive)
- Self-healing
- Low loss
- Low ESL
- Low profile dimensions available
- High ripple current
- High dV/dt
- High capacitance density
- High contact reliability
- Suitable for high frequency applications
- Automotive Grades (AEC-Q200)

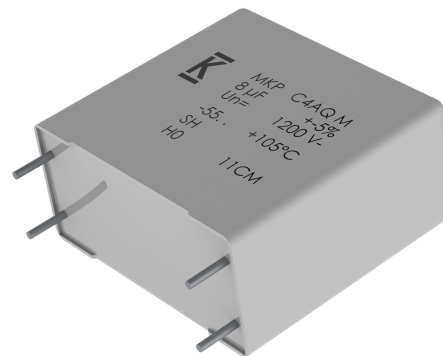

Part Number System

C4	A	Q	U	B	W	5270	A	3	N	J
Series	Type	Application	Rated Voltage (VDC)	Case	Terminals Code	Capacitance Code (pF)	Release	Lead Diameter (mm)	Size Code	Tolerance
C4 = MKP Power Capacitors	A = Box, wire terminals	Q = DC Link Automotive Grade	L = 500 J = 700 I = 800 O = 900 N = 1000 Q = 1,100 P = 1,200	B, E = Box plastic case L = Low Profile box, plastic case	U = 2 pins W = 4 pins	Digits two – four indicate the first three digits of the capacitance value. First digit indicates the number of zeros to be added.	M = Standard Miniature Version	1 = 0.8 2 = 1.0 3 = 1.2	See dimensions table below for valid case sizes	J = 5% K = 10%

Built Into Tomorrow

Dimensions – Millimeters

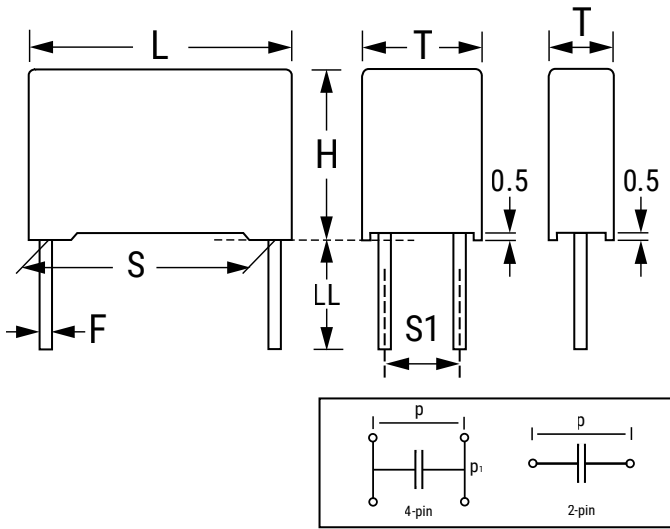

Size Code		S		S1		T		H		L		LL		F	
Digit 6	Digit 14	Nominal	Tolerance	Nominal	Tolerance	Nominal	Tolerance	Nominal	Tolerance	Nominal	Tolerance	Nominal	Tolerance	Nominal	Tolerance
B	W	27.5	±0.4	-	-	11.0	+0.3/-0.7	20.0	+0.2/-0.7	31.5	+0.5/-0.7	6	+0/-2	0.8	±0.05
B	X	27.5	±0.4	-	-	13.0	+0.3/-0.7	25.0	+0.2/-0.7	31.5	+0.5/-0.7	6	+0/-2	0.8	±0.05
B	Y	27.5	±0.4	-	-	14.0	+0.3/-0.7	28.0	+0.2/-0.7	31.5	+0.5/-0.7	6	+0/-2	0.8	±0.05
B	8	27.5	±0.4	-	-	16.0	+0.3/-0.7	30.0	+0.2/-0.7	32.0	+0.5/-0.7	6	+0/-2	0.8	±0.05
B	E	27.5	±0.4	-	-	18.0	+0.6/-0.7	33.0	+0.2/-0.7	32.0	+0.5/-0.7	6	+0/-2	0.8	±0.05
B	1	27.5	±0.4	-	-	19.0	+0.3/-0.7	29.0	+0.2/-0.7	31.5	+0.5/-0.7	6	+0/-2	0.8	±0.05
B	2	27.5	±0.4	-	-	22.0	+0.3/-0.7	37.0	+0.2/-0.7	31.5	+0.5/-0.7	6	+0/-2	0.8	±0.05
B	F	37.5	±0.4	10.2	±0.4	20.0	+0.4/-0.7	40.0	+0.2/-0.7	42.0	+0.6/-0.7	6	+0/-2	1.2	±0.05
B	J	37.5	±0.4	10.2	±0.4	28.0	+0.4/-0.7	37.0	+0.2/-0.7	42.0	+0.6/-0.7	6	+0/-2	1.2	±0.05
B	H	37.5	±0.4	10.2	±0.4	24.0	+0.4/-0.7	44.0	+0.2/-0.7	41.5	+0.6/-0.7	6	+0/-2	1.2	±0.05
B	L	37.5	±0.4	20.3	±0.4	30.0	+0.4/-0.7	45.0	+0.2/-0.7	42.0	+0.6/-0.7	6	+0/-2	1.2	±0.05
B	6	37.5	±0.4	20.3	±0.4	35.0	+0.4/-0.7	46.0	+0.2/-0.7	42.0	+0.6/-0.7	6	+0/-2	1.2	±0.05
B	O	37.5	±0.4	20.3	±0.4	35.0	+0.4/-0.7	50.0	+0.2/-0.7	42.0	+0.6/-0.7	6	+0/-2	1.2	±0.05
E	C	37.5	±0.4	20.3	±0.4	38.0	+0.5/-0.7	57.0	+0.3/-0.7	42.0	+0.6/-0.7	6	+0/-2	1.2	±0.05
B	M	52.5	±0.4	20.3	±0.4	30.0	+0.5/-0.7	45.0	+0.3/-0.7	57.5	+0.8/-0.7	6	+0/-2	1.2	±0.05
B	N	52.5	±0.4	20.3	±0.4	35.0	+0.5/-0.7	50.0	+0.3/-0.7	57.5	+0.8/-0.7	6	+0/-2	1.2	±0.05
E	A	52.5	±0.4	20.3	±0.4	45.0	+0.5/-0.7	56.0	+0.3/-0.7	57.5	+0.8/-0.7	6	+0/-2	1.2	±0.05
E	B	52.5	±0.4	20.3	±0.4	45.0	+0.5/-0.7	65.0	+0.3/-0.7	57.5	+0.8/-0.7	6	+0/-2	1.2	±0.05
L	1	27.7	±0.4	-	-	21.0	+0.3/-0.7	12.5	+0.2/-0.7	32.0	+0.5/-0.7	6	+0/-2	0.8	±0.05
L	2	27.5	±0.4	-	-	24.0	+0.3/-0.7	15.0	+0.2/-0.7	32.0	+0.5/-0.7	6	+0/-2	0.8	±0.05
L	9	27.5	±0.4	-	-	31.0	+0.3/-0.7	19.0	+0.2/-0.7	32.0	+0.5/-0.7	6	+0/-2	0.8	±0.05
L	4	37.5	±0.4	10.2	±0.4	24.0	+0.4/-0.7	15.0	+0.2/-0.7	41.5	+0.6/-0.7	6	+0/-2	1.2	±0.05
L	3	37.5	±0.4	10.2	±0.4	24.0	+0.4/-0.7	19.0	+0.2/-0.7	41.5	+0.6/-0.7	6	+0/-2	1.2	±0.05
L	6	37.5	±0.4	20.3	±0.4	35.0	+0.4/-0.7	24.0	+0.2/-0.7	42.0	+0.6/-0.7	6	+0/-2	1.2	±0.05
L	8	37.5	±0.4	20.3	±0.4	43.0	+0.4/-0.7	25.0	+0.2/-0.7	42.0	+0.6/-0.7	6	+0/-2	1.2	±0.05

Qualification

Reference Standards	IEC 61071, EN 61071, VDE0560
Climatic Category	55/105/56 according to IEC 60068-1

Automotive grade products meet or exceed the requirements outlined by the Automotive Electronics Council. Details regarding test methods and conditions are referenced in document AEC-Q200, Stress Test Qualification for Passive Components. For additional information regarding the Automotive Electronics Council and AEC-Q200, visit the AEC website at www.aecouncil.com.

General Technical Data

Dielectric	Polypropylene metallized film, non-inductive type, self-healing property
Application	DC filtering, DC link
Special Features	AEC-Q200 qualified
Climatic Category	55/105/56 IEC 60068-1
Temperature Range	-55°C to +105°C
Endurance Test	500 hours + 500 hours at $1.3 \times V_{NDC}$ at 85°C
Standard	IEC 61071, EN 61071, VDE0560, AEC-Q200
Protection	Solvent resistant plastic case UL 94 V-0 compliant Thermosetting resin sealing UL 94 V-0 compliant
Installation	Any position
Leads	Tinned wires, standard lead wire length 6 (+0/-2) mm
Packaging	Packed in cardboard trays with protection for the terminals
RoHS Compliance	Compliant with Directive 2002/95/EC and Directive 2011/65/EU of the European Parliament and the Council of the EU on 8 June 2011, including the Commission Delegated Directive (EU) 2015/863 that amended Annex II to Directive 2011/65/EU.

Electrical Characteristics

Rated Capacitance Range	1.1 – 210 μ F
Rated Voltage (V_{NDC}) Range	500 to 1,200 VDC
Capacitance Tolerance	$\pm 5\%$ (J) or $\pm 10\%$ (K) measured at $T = +25^{\circ}\text{C} \pm 5^{\circ}\text{C}$
Dissipation Factor PP Typical (tg δ)	≤ 0.0002 at 10 kHz with $T = 25^{\circ}\text{C} \pm 5^{\circ}\text{C}$
Surge Voltage	$1.5 * V_{NDC}$ for maximum 10 times in a lifetime at $25^{\circ}\text{C} \pm 5^{\circ}\text{C}$
Overvoltage (IEC 61071)	$1.15 * V_{NDC}$ for maximum 30 minutes, once per day
	$1.3 * V_{NDC}$ for maximum 1 minute, once per day
Peak Non-Repetitive Current	$1.5 * I_{PKR}$ for maximum 1,000 times in a lifetime
Insulation Resistance	$IR * C \geq 30.000$ seconds at 100 VDC 1 minute at $T = +25^{\circ}\text{C} \pm 5^{\circ}\text{C}$
Capacitance Deviation in Operation	$\pm 2.0\%$ maximum on capacitance value measured at $T = +25^{\circ}\text{C} \pm 5^{\circ}\text{C}$
Temperature Storage	-40 to $+80^{\circ}\text{C}$
Storage time	≤ 36 months from the date marked on the label glued to the package
Permissible Relative Humidity - Storage	Annual average $\leq 70\%$, 85% on 30 days/year randomly distributed throughout year. Dewing not admissible.

Life Expectancy

Life expectancy	120,000 hours at V_{NDC} at hot spot temperature $THS = +70^{\circ}\text{C}$
	60,000 hours at V_{NDC} at hot spot temperature $THS = +85^{\circ}\text{C}$
	40,000 hours at VOP_{105} at hot spot temperature $THS = +105^{\circ}\text{C}$
	500 hours at $0.7 * VOP_{85}$ at hot spot temperature $THS = +115^{\circ}\text{C}$
	200 hours at $0.6 * VOP_{85}$ at hot spot temperature $THS = +125^{\circ}\text{C}$
Capacitance Drop at End of Life	-5% (typical)
Failure Rate IEC 61709	≤ 280 FIT at V_{NDC} at hot spot temperature $THS = +85^{\circ}\text{C}$
	≤ 280 FIT at V_{NDC} at hot spot temperature $THS = +85^{\circ}\text{C}$

Test Method

Test Voltage Between Terminals	1.5 * V _{NDC} for 10 seconds or 1.65 * V _{NDC} for 2 seconds, at T = +25°C ±5°C
Test Voltage Between Terminals and Case	3.2 k VAC 50 Hz for 2 seconds
Damp Heat	IEC 60068-2-78
Change of Temperature	IEC 60068-2-14
Biased Humidity Test 40°C/93% R.H. at V _{NDC} - 1,000 hours	ΔC/C ₀ ≤ 5% ΔDF/DF ₀ ≤ 200% (at 10 kHz) IR ≥ 50% of initial limit
Biased Humidity Test 60°C/95% R.H. at V _{NDC} - 1,000 hours	ΔC/C ₀ ≤ 5% ΔDF/DF ₀ ≤ 200% (at 10 kHz) IR ≥ 100 MΩ

Operative Voltage Derating

	Symbol	Voltage (VDC)						
Operating Voltage at 70°C (T _{HS})	V _{OP70}	600	800	960	1100	1,200	1,320	1,440
Rated Voltage at 85°C (T _{HS})	V _{NDC}	500	700	800	900	1,000	1,100	1,200
Operating Voltage at 105°C (T _{HS})	V _{OP105}	350	490	560	650	700	770	850

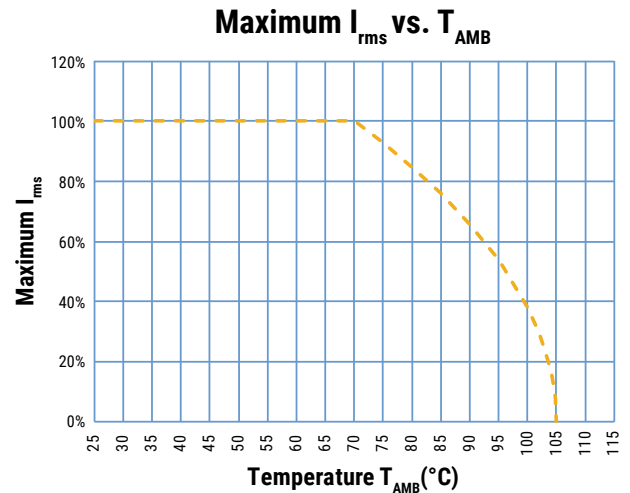
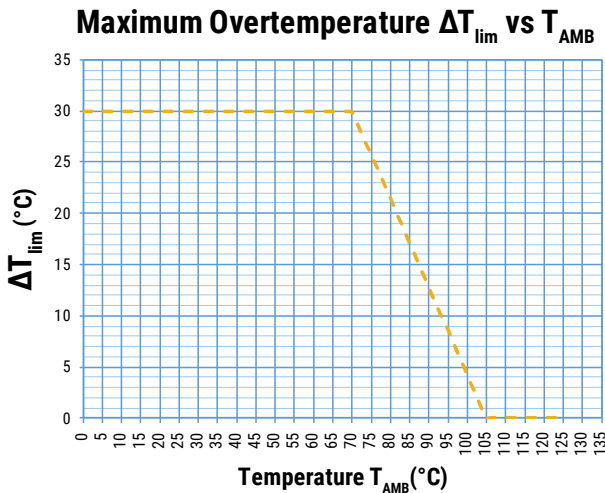

Typical Waveforms

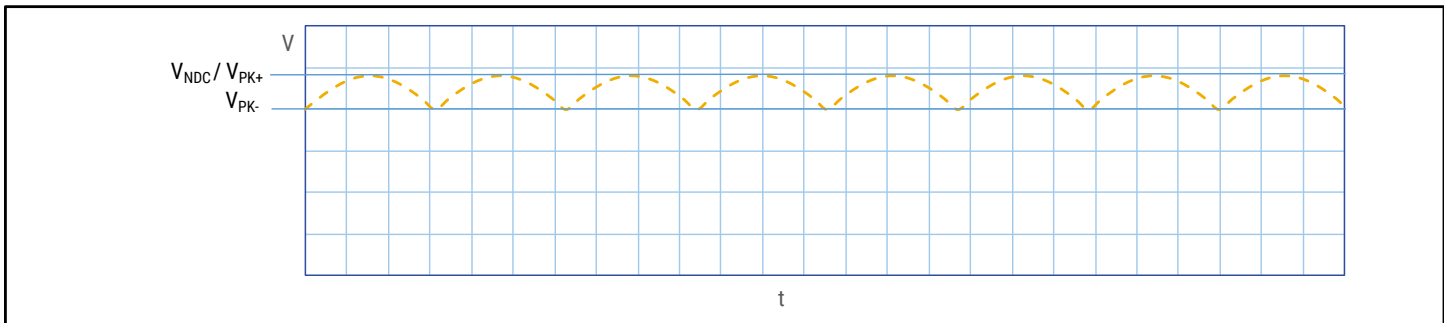
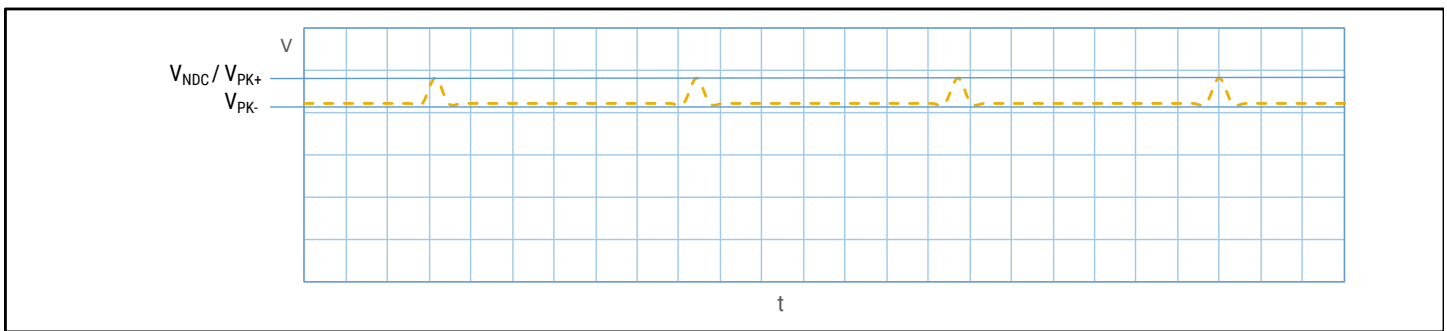
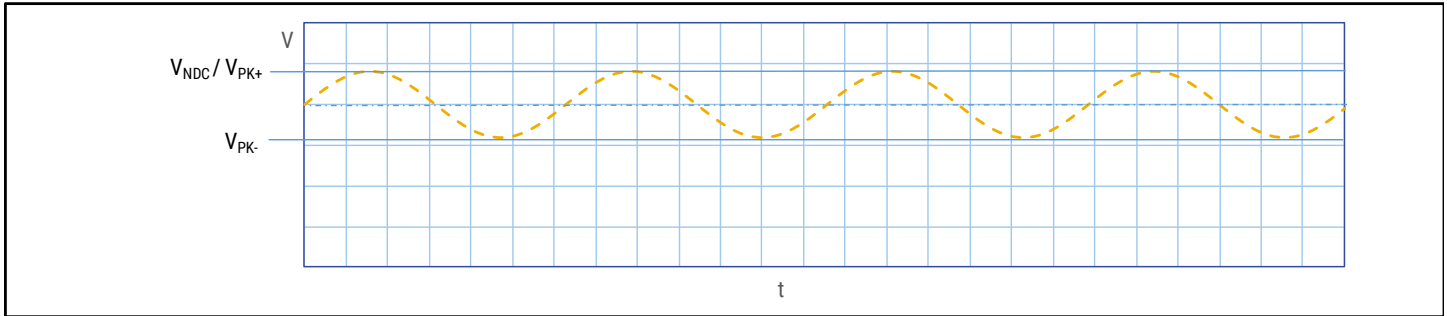

*The applied peak-to-peak ripple voltage shall not exceed $0.1 \times V_{NDC}$.
 The peak voltage shall not exceed the rated voltage V_{NDC} .*

Life Expectancy/Failure Quota Graphs

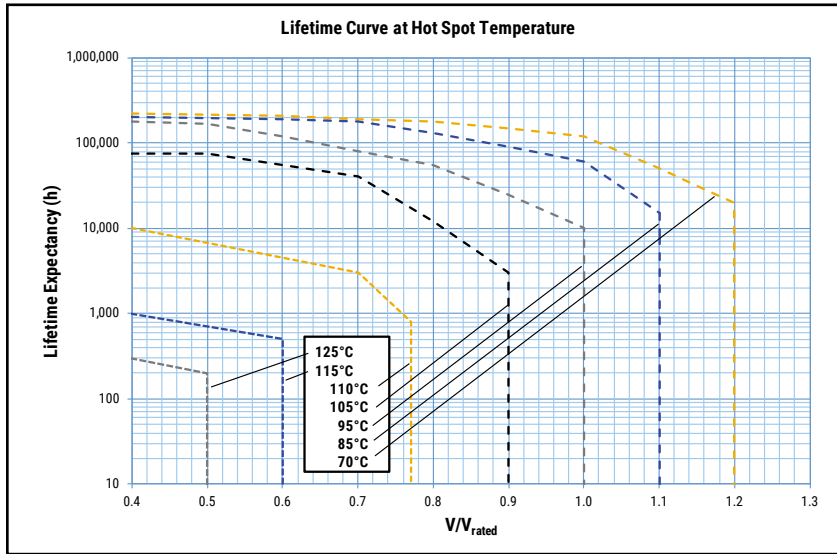

Notes:

$$T_{HS} = T_{AMB} + \Delta T$$

$$\Delta T = ESR * I_{rms}^2 * Rth$$

I_{rms} should be limited to values granting $\Delta T \leq 30^\circ C$

Confidence Level = 90%

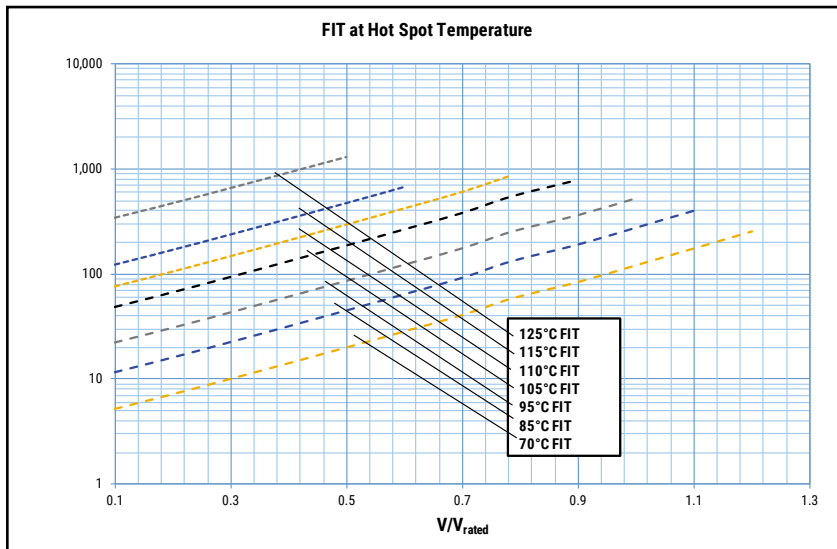

Notes:

Failure rate λ (FIT) data based on IEC 61709 standard

Environmental Compliance

As a leading global supplier of electronic components and an environmentally conscious company, KEMET continually aspires to improve the environmental effects of our manufacturing processes and our finished electronic components.

In Europe (RoHS Directive) and in some other geographical areas such as China (China RoHS), legislation has been enacted to prevent or otherwise limit the use of certain hazardous materials, including lead (Pb), in electronic equipment. KEMET monitors legislation globally to ensure compliance and endeavors to adjust our manufacturing processes and/or electronic components as may be required by applicable law.

For military, medical, automotive, and some commercial applications, the use of lead (Pb) in the termination is necessary and/or required by design. KEMET is committed to communicating RoHS compliance to our customers. Information related to RoHS compliance will be provided in data sheets and using specific identifiers on the packaging labels.

All KEMET power film capacitors are RoHS compliant.

Materials & Environment

The selection of raw materials that KEMET uses for the production of its electronic components is the result of extensive experience. KEMET directs specific attention toward environmental protection. KEMET selects its suppliers according to ISO 9001 standards and performs statistical analyses on raw materials before acceptance for use in manufacturing our electronic components. All materials are, to the best of KEMET's knowledge, non-toxic and free from cadmium; mercury; chrome and compounds; polychlorine triphenyl (PCB); bromide and chlorinedioxins bromurate clorurate; CFC and HCFC; and asbestos.

Dissipation Factor

Dissipation factor is a complex function involved with capacitor inefficiency. The $\tan\delta$ may vary up and down with increased temperature. For more information, refer to Performance Characteristics.

Sealing

Hermetically Sealed Capacitors

As the temperature increases, the pressure inside the capacitor increases. If the internal pressure is high enough, it can cause a breach in the capacitor. Such a breach can result in leakage, impregnation, filling fluid, or moisture susceptibility.

Barometric Pressure

The altitude at which hermetically sealed capacitors are operated controls the capacitor's voltage rating. As the barometric pressure decreases, the susceptibility to terminal arc-over increases. Non-hermetic capacitors can be affected by internal stresses due to pressure changes. These effects can be in the form of capacitance changes, dielectric arc-over, and/or low insulation resistance. Altitude can also affect heat transfer. Heat that is generated in an operation cannot be dissipated properly, and high RI^2 losses and eventual failure can result.

Power and AC Film Capacitors – Printed Circuit Board Mount Power Film Capacitors
C4AQ Miniaturized, Radial, 2 or 4 Leads, 500 – 1,200 VDC, for DC Link (Automotive Grade)

Table 1 – Ratings & Part Number Reference

Cap Value (µF)	VDC	Dimensions (mm)					dV/dt V/µs	Ipkr Apk	ESL nH	ESR 70°C at 10 kHz mΩ	Irms* 70°C at 10 kHz Arms	Rth (HS/Amb) (°C/W)	Packaging Quantity	PART NUMBER
		T	H	L	S	S1								
V_{OPT0} at 70°C = 600 VDC; V_{NDC} at 85°C = 500 VDC; V_{OP105} at 105°C = 350 VDC														
5.6	500	11	20	31.5	27.5	/	65	364	17	12.7	6.8	44	256	C4AQLBU4560M1WK
10	500	13	25	31.5	27.5	/	65	650	22	7.8	9.6	36	234	C4AQLBU5100M1XK
12.5	500	14	28	31.5	27.5	/	65	812.5	24	6.7	11.0	33	96	C4AQLBU5125M1YK
14	500	16	30	32	27.5	/	65	910	25	6.2	12.0	29	88	C4AQLBU5140M18K
15	500	19	29	31.5	27.5	/	65	975	25	5.6	12.9	29	72	C4AQLBU5150M11K
18	500	18	33	32	27.5	/	65	1170	27	5.3	13.7	27	80	C4AQLBU5180M1EK
25	500	22	37	31.5	27.5	/	65	1625	28	4.4	16.0	23	64	C4AQLBU5250M12K
40	500	20	40	42	37.5	10.2	30	1200	12	3.4	19.6	20	58	C4AQLBW5400M3FK
50	500	28	37	42	37.5	10.2	30	1500	10	2.8	22.8	18	36	C4AQLBW5500M3JK
54	500	24	44	41.5	37.5	10.2	30	1620	13	2.6	24.2	17	44	C4AQLBW5540M3HK
70	500	30	45	42	37.5	20.3	30	2100	13	2.1	29.1	15	36	C4AQLBW5700M3LK
80	500	35	46	42	37.5	20.3	30	2400	13	1.8	32.4	14	30	C4AQLBW5800M36K
90	500	35	50	42	37.5	20.3	30	2700	13	1.7	35.1	13	30	C4AQLBW5900M30K
110	500	38	57	42	37.5	20.3	30	3300	17	1.4	40.8	11	24	C4AQLEW6110M3CK
100	500	30	45	57.5	52.5	20.3	15	1500	13	2.9	27.4	12	27	C4AQLBW6100M3MK
130	500	35	50	57.5	52.5	20.3	15	1950	15	2.3	33.3	10	23	C4AQLBW6130M3NK
180	500	45	56	57.5	52.5	20.3	15	2700	17	1.7	42.6	8	18	C4AQLEW6180M3AK
210	500	45	65	57.5	52.5	20.3	15	3150	19	1.6	47.7	7	18	C4AQLEW6210M3BK
V_{OPT0} at 70°C = 800 VDC; V_{NDC} at 85°C = 700 VDC; V_{OP105} at 105°C = 490 VDC														
3.3	700	11	20	31.5	27.5	/	65	214.5	17	17.0	5.9	44	256	C4AQJBU4330M1WJ
5.6	700	13	25	31.5	27.5	/	65	364	22	10.7	8.2	36	234	C4AQJBU4560M1XJ
7	700	14	28	31.5	27.5	/	65	455	24	9.0	9.5	33	96	C4AQJBU4700M1YJ
8.8	700	16	30	32	27.5	/	65	572	25	7.5	10.9	29	88	C4AQJBU4880M18J
10	700	19	29	31.5	27.5	/	65	650	25	6.8	11.7	29	72	C4AQJBU5100M11J
11	700	18	33	32	27.5	/	65	715	27	6.4	12.4	27	80	C4AQJBU5110M1EJ
15	700	22	37	31.5	27.5	/	65	975	28	5.3	14.6	23	64	C4AQJBU5150M12J
25	700	20	40	42	37.5	10.2	30	750	12	4.3	17.4	20	58	C4AQJBW5250M3FJ
30	700	28	37	42	37.5	10.2	30	900	10	3.6	19.9	18	36	C4AQJBW5300M3JJ
33	700	24	44	41.5	37.5	10.2	30	990	13	3.3	21.3	17	44	C4AQJBW5330M3HJ
40	700	30	45	42	37.5	20.3	30	1200	13	2.8	24.9	15	36	C4AQJBW5400M3LJ
45	700	35	46	42	37.5	20.3	30	1350	13	2.5	27.6	14	30	C4AQJBW5450M36J
50	700	35	50	42	37.5	20.3	30	1500	13	2.3	29.9	13	30	C4AQJBW5500M30J
66	700	38	57	42	37.5	20.3	30	1980	17	1.8	36.2	11	24	C4AQJEW5660M3CJ
55	700	30	45	57.5	52.5	20.3	15	825	13	4.1	23.0	12	27	C4AQJBW5550M3MJ
75	700	35	50	57.5	52.5	20.3	15	1125	15	3.1	28.7	10	23	C4AQJBW5750M3NJ
110	700	45	56	57.5	52.5	20.3	15	1650	17	2.2	37.9	8	18	C4AQJEW6110M3AJ
130	700	45	65	57.5	52.5	20.3	15	1950	19	1.9	42.9	7	18	C4AQJEW6130M3BJ
Cap Value (µF)	VDC	T	H	L	S	S1	V/µs	Apk	nH	mΩ	Arms	(°C/W)	Packaging Quantity	PART NUMBER
		Dimensions (mm)					dV/dt	Ipkr	ESL	ESR 70°C at 10 kHz	Irms* 70°C at 10 kHz	Rth (HS/Amb)		

(*) I_{rms} value that leads to a ΔT of $\approx 30^\circ C$ in the hot spot $> T_{HS} = T_{AMB} + \Delta T = 70^\circ C + 30^\circ C = 100^\circ C$. Attention: Hot spot at $100^\circ C$ reduced the life time!

Power and AC Film Capacitors – Printed Circuit Board Mount Power Film Capacitors
C4AQ Miniaturized, Radial, 2 or 4 Leads, 500 – 1,200 VDC, for DC Link (Automotive Grade)

Table 1 – Ratings & Part Number Reference cont.

Cap Value (µF)	VDC	Dimensions (mm)					dV/dt V/µs	Ipkr Apk	ESL nH	ESR 70°C at 10 kHz mΩ	Irms* 70°C at 10 kHz Arms	Rth (HS/Amb) (°C/W)	Packaging Quantity	PART NUMBER	
		T	H	L	S	S1									
V_{OP70} at 70°C = 960 VDC; V_{NDC} at 85°C = 800 VDC; V_{OP105} at 105°C = 560 VDC															
2.7	800	11	20	31.5	27.5	/	65	175.5	17	18.3	5.7	44	256	C4AQIBU4270M1WJ	
4	800	13	25	31.5	27.5	/	65	260	22	12.9	7.5	36	234	C4AQIBU4400M1XJ	
5	800	14	28	31.5	27.5	/	65	325	24	10.7	8.7	33	96	C4AQIBU4500M1YJ	
6.5	800	16	30	32	27.5	/	65	422.5	25	8.7	10.1	29	88	C4AQIBU4650M18J	
8	800	19	29	31.5	27.5	/	65	520	25	7.3	11.2	29	72	C4AQIBU4800M11J	
8.5	800	18	33	32	27.5	/	65	552.5	27	7.1	11.8	27	80	C4AQIBU4850M1EJ	
12	800	22	37	31.5	27.5	/	65	780	28	5.7	14.1	23	64	C4AQIBU5120M12J	
15	800	20	40	42	37.5	10.2	30	450	12	6.2	14.5	20	58	C4AQIBW5150M3FJ	
22	800	28	37	42	37.5	10.2	30	660	10	4.3	18.2	18	36	C4AQIBW5220M3JJ	
24	800	24	44	41.5	37.5	10.2	30	720	13	4.0	19.5	17	44	C4AQIBW5240M3HJ	
30	800	30	45	42	37.5	20.3	30	900	13	3.2	23.2	15	36	C4AQIBW5300M3LJ	
35	800	35	46	42	37.5	20.3	30	1050	13	2.8	26.1	14	30	C4AQIBW5350M36J	
40	800	35	50	42	37.5	20.3	30	1200	13	2.5	28.7	13	30	C4AQIBW5400M3OJ	
52	800	38	57	42	37.5	20.3	30	1560	17	2.0	34.5	11	24	C4AQIEW5520M3CJ	
45	800	30	45	57.5	52.5	20.3	15	675	13	4.4	22.3	12	27	C4AQIBW5450M3MJ	
60	800	35	50	57.5	52.5	20.3	15	900	15	3.3	27.5	10	23	C4AQIBW5600M3NJ	
85	800	45	56	57.5	52.5	20.3	15	1275	17	2.5	35.8	8	18	C4AQIEW5850M3AJ	
100	800	45	65	57.5	52.5	20.3	15	1500	19	2.2	40.6	7	18	C4AQIEW6100M3BJ	
V_{OP70} at 70°C = 1,100 VDC; V_{NDC} at 85°C = 900 VDC; V_{OP105} at 105°C = 650 VDC															
2	900	11	20	31.5	27.5	/	70	140	17	21.9	5.2	44	256	C4AQOBU4200M1WJ	
3.5	900	13	25	31.5	27.5	/	70	245	22	13.2	7.4	36	234	C4AQOBU4350M1XJ	
4.4	900	14	28	31.5	27.5	/	70	308	24	10.9	8.6	33	96	C4AQOBU4440M1YJ	
5.2	900	16	30	32	27.5	/	70	364	25	9.5	9.7	29	88	C4AQOBU4520M18J	
6.3	900	19	29	31.5	27.5	/	70	441	25	8.1	10.6	29	72	C4AQOBU4630M11J	
7	900	18	33	32	27.5	/	70	490	27	7.6	11.4	27	80	C4AQOBU4700M1EJ	
10	900	22	37	31.5	27.5	/	70	700	28	6.0	13.8	23	64	C4AQOBU5100M12J	
14	900	20	40	42	37.5	10.2	35	490	12	6.0	14.8	20	58	C4AQOBW5140M3FJ	
18	900	28	37	42	37.5	10.2	35	630	10	4.7	17.5	18	36	C4AQOBW5180M3JJ	
20	900	24	44	41.5	37.5	10.2	35	700	13	4.3	18.9	17	44	C4AQOBW5200M3HJ	
25	900	30	45	42	37.5	20.3	35	875	13	3.5	22.4	15	36	C4AQOBW5250M3LJ	
28	900	35	46	42	37.5	20.3	35	980	13	3.1	24.8	14	30	C4AQOBW5280M36J	
33	900	35	50	42	37.5	20.3	35	1155	13	2.7	27.6	13	30	C4AQOBW5330M3OJ	
40	900	38	57	42	37.5	20.3	35	1400	17	2.3	32.4	11	24	C4AQOEW5400M3CJ	
36	900	30	45	57.5	52.5	20.3	15	540	13	4.8	21.2	12	27	C4AQOBW5360M3MJ	
45	900	35	50	57.5	52.5	20.3	15	675	15	3.9	25.4	10	23	C4AQOBW5450M3NJ	
65	900	45	56	57.5	52.5	20.3	15	975	17	2.8	33.5	8	18	C4AQOEW5650M3AJ	
80	900	45	65	57.5	52.5	20.3	15	1200	19	2.4	38.7	7	18	C4AQOEW5800M3BJ	
Cap Value (µF)	VDC	T	H	L	S	S1	V/µs	Apk	nH	mΩ	Arms	(°C/W)	Packaging Quantity	PART NUMBER	
		Dimensions (mm)					dV/dt	Ipkr	ESL	ESR 70°C at 10 kHz	Irms* 70°C at 10 kHz	Rth (HS/Amb)			

(*) I_{rms} value that leads to a ΔT of ≈ 30°C in the hot spot > T_{HS} = T_{AMB} + ΔT = 70°C + 30°C = 100°C. Attention: Hot spot at 100°C reduced the life time!

Power and AC Film Capacitors – Printed Circuit Board Mount Power Film Capacitors
C4AQ Miniaturized, Radial, 2 or 4 Leads, 500 – 1,200 VDC, for DC Link (Automotive Grade)

Table 1 – Ratings & Part Number Reference cont.

Cap Value (µF)	VDC	Dimensions (mm)					dV/dt V/µs	Ipkr Apk	ESL nH	ESR 70°C at 10 kHz mΩ	Irms* 70°C at 10 kHz Arms	Rth (HS/Amb) (°C/W)	Packaging Quantity	PART NUMBER	
		T	H	L	S	S1									
V_{OP70} at 70°C = 1,200 VDC; V_{NDC} at 85°C = 1,000 VDC; V_{OP105} at 105°C = 700 VDC															
1.7	1,000	11	20	31.5	27.5	/	75	127.5	17	23.3	5.1	44	256	C4AQNBU4170M1WJ	
2.7	1,000	13	25	31.5	27.5	/	75	202.5	22	15.3	6.9	36	234	C4AQNBU4270M1XJ	
3.3	1,000	14	28	31.5	27.5	/	75	247.5	24	12.9	7.9	33	96	C4AQNBU4330M1YJ	
4	1,000	16	30	32	27.5	/	75	300	25	11.0	9.0	29	88	C4AQNBU4400M18J	
5	1,000	19	29	31.5	27.5	/	75	375	25	9.1	10.1	29	72	C4AQNBU4500M11J	
5.5	1,000	18	33	32	27.5	/	75	412.5	27	8.5	10.8	27	80	C4AQNBU4550M1EJ	
8	1,000	22	37	31.5	27.5	/	75	600	28	6.6	13.2	23	64	C4AQNBU4800M12J	
12	1,000	20	40	42	37.5	10.2	37	444	12	6.3	14.4	20	58	C4AQNBU5120M3FJ	
14	1,000	28	37	42	37.5	10.2	37	518	10	5.4	16.3	18	36	C4AQNBU5140M3JJ	
15	1,000	24	44	41.5	37.5	10.2	37	555	13	5.1	17.3	17	44	C4AQNBU5150M3HJ	
20	1,000	30	45	42	37.5	20.3	37	740	13	3.9	21.2	15	36	C4AQNBU5200M3LJ	
22	1,000	35	46	42	37.5	20.3	37	814	13	3.6	23.3	14	30	C4AQNBU5220M36J	
25	1,000	35	50	42	37.5	20.3	37	925	13	3.2	25.5	13	30	C4AQNBU5250M30J	
33	1,000	38	57	42	37.5	20.3	37	1221	17	2.5	31.1	11	24	C4AQNBU5330M3CJ	
30	1,000	30	45	57.5	52.5	20.3	17	510	13	5.2	20.4	12	27	C4AQNBU5300M3MJ	
40	1,000	35	50	57.5	52.5	20.3	17	680	15	4.0	25.2	10	23	C4AQNBU5400M3NJ	
55	1,000	45	56	57.5	52.5	20.3	17	935	17	3.0	32.5	8	18	C4AQNBU5550M3AJ	
65	1,000	45	65	57.5	52.5	20.3	17	1105	19	2.6	37.0	7	18	C4AQNBU5650M3BJ	
V_{OP70} at 70°C = 1,320 VDC; V_{NDC} at 85°C = 1,100 VDC; V_{OP105} at 105°C = 770 VDC															
1.4	1,100	11	20	31.5	27.5	/	80	112	17	25.9	4.8	44	256	C4AQQBU4140M1WJ	
2.2	1,100	13	25	31.5	27.5	/	80	176	22	17.1	6.5	36	234	C4AQQBU4220M1XJ	
2.7	1,100	14	28	31.5	27.5	/	80	216	24	14.3	7.5	33	96	C4AQQBU4270M1YJ	
3.3	1,100	16	30	32	27.5	/	80	264	25	12.0	8.6	29	88	C4AQQBU4330M18J	
4	1,100	19	29	31.5	27.5	/	80	320	25	10.2	9.5	29	72	C4AQQBU4400M11J	
4.4	1,100	18	33	32	27.5	/	80	352	27	9.5	10.2	27	80	C4AQQBU4440M1EJ	
6.6	1,100	22	37	31.5	27.5	/	80	528	28	7.1	12.6	23	64	C4AQQBU4660M12J	
10	1,100	20	40	42	37.5	10.2	40	400	12	6.9	13.8	20	58	C4AQQBU5100M3FJ	
12	1,100	28	37	42	37.5	10.2	40	480	10	5.7	15.8	18	36	C4AQQBU5120M3JJ	
13	1,100	24	44	41.5	37.5	10.2	40	520	13	5.4	16.9	17	44	C4AQQBU5130M3HJ	
16	1,100	30	45	42	37.5	20.3	40	640	13	4.4	19.9	15	36	C4AQQBU5160M3LJ	
18	1,100	35	46	42	37.5	20.3	40	720	13	3.9	22.1	14	30	C4AQQBU5180M36J	
20	1,100	35	50	42	37.5	20.3	40	800	13	3.6	24.0	13	30	C4AQQBU5200M30J	
27	1,100	38	57	42	37.5	20.3	40	1080	17	2.8	29.6	11	24	C4AQQBU5270M3CJ	
24	1,100	30	45	57.5	52.5	20.3	20	480	13	5.9	19.2	12	27	C4AQQBU5240M3MJ	
30	1,100	35	50	57.5	52.5	20.3	20	600	15	4.8	23.0	10	23	C4AQQBU5300M3NJ	
45	1,100	45	56	57.5	52.5	20.3	20	900	17	3.3	31.0	8	18	C4AQQBU5450M3AJ	
55	1,100	45	65	57.5	52.5	20.3	20	1100	19	2.8	35.8	7	18	C4AQQBU5550M3BJ	
Cap Value (µF)	VDC	T	H	L	S	S1	V/µs	Apk	nH	mΩ	Arms	(°C/W)	Packaging Quantity	PART NUMBER	
		Dimensions (mm)					dV/dt	Ipkr	ESL	ESR 70°C at 10 kHz	Irms* 70°C at 10 kHz	Rth (HS/Amb)			

(*) I_{rms} value that leads to a ΔT of ≈ 30°C in the hot spot > T_{HS} = T_{AMB} + ΔT = 70°C + 30°C = 100°C. Attention: Hot spot at 100°C reduced the life time!

Table 1 – Ratings & Part Number Reference cont.

Cap Value (µF)	VDC	Dimensions (mm)					dV/dt V/µs	lpkr Apk	ESL nH	ESR 70°C at 10 kHz mΩ	Irms* 70°C at 10 kHz Arms	Rth (HS/Amb) (°C/W)	Packaging Quantity	PART NUMBER
		T	H	L	S	S1								
V_{OP70} at 70°C = 1,440 VDC; V_{NDC} at 85°C = 1,200 VDC; V_{OP105} at 105°C = 850 VDC														
1.1	1,200	11	20	31.5	27.5	/	90	99	17	29.1	4.5	44	256	C4AQPBU4110M1WJ
1.8	1,200	13	25	31.5	27.5	/	90	162	22	18.5	6.3	36	234	C4AQPBU4180M1XJ
2.2	1,200	14	28	31.5	27.5	/	90	198	24	15.5	7.2	33	96	C4AQPBU4220M1YJ
2.7	1,200	16	30	32	27.5	/	90	243	25	13.0	8.3	29	88	C4AQPBU4270M18J
3.3	1,200	19	29	31.5	27.5	/	90	297	25	10.9	9.2	29	72	C4AQPBU4330M11J
3.7	1,200	18	33	32	27.5	/	90	333	27	10.0	9.9	27	80	C4AQPBU4370M1EJ
5	1,200	22	37	31.5	27.5	/	90	450	28	8.0	11.9	23	64	C4AQPBU4500M12J
8	1,200	20	40	42	37.5	10.2	45	360	12	7.7	13.1	20	58	C4AQPBU4800M3FJ
10	1,200	28	37	42	37.5	10.2	45	450	10	6.2	15.2	18	36	C4AQPBU5100M3JJ
11	1,200	24	44	41.5	37.5	10.2	45	495	13	5.6	16.4	17	44	C4AQPBU5110M3HJ
13	1,200	30	45	42	37.5	20.3	45	585	13	4.8	19.0	15	36	C4AQPBU5130M3LJ
15	1,200	35	46	42	37.5	20.3	45	675	13	4.2	21.4	14	30	C4AQPBU5150M36J
17	1,200	35	50	42	37.5	20.3	45	765	13	3.8	23.4	13	30	C4AQPBU5170M30J
22	1,200	38	57	42	37.5	20.3	45	990	17	3.0	28.4	11	24	C4AQPBU5220M3CJ
20	1,200	30	45	57.5	52.5	20.3	23	460	13	6.3	18.5	12	27	C4AQPBU5200M3MJ
25	1,200	35	50	57.5	52.5	20.3	23	575	15	5.1	22.2	10	23	C4AQPBU5250M3NJ
36	1,200	45	56	57.5	52.5	20.3	23	828	17	3.7	29.3	8	18	C4AQPBU5360M3AJ
45	1,200	45	65	57.5	52.5	20.3	23	1035	19	3.0	34.3	7	18	C4AQPBU5450M3BJ
Cap Value (µF)	VDC	T	H	L	S	S1	V/µs	Apk	nH	mΩ	Arms	(°C/W)	Packaging Quantity	PART NUMBER
		Dimensions (mm)					dV/dt	lpkr	ESL	ESR 70°C at 10 kHz	Irms* 70°C at 10 kHz	Rth (HS/Amb)		

(*) I_{rms} value that leads to a ΔT of $\approx 30^\circ C$ in the hot spot $> T_{HS} = T_{AMB} + \Delta T = 70^\circ C + 30^\circ C = 100^\circ C$. Attention: Hot spot at $100^\circ C$ reduced the life time!

Table 2 – Ratings & Part Number Reference for Low Profile Design

Cap Value (µF)	VDC	Dimensions (mm)					dV/dt V/µs	Ipkr Apk	ESL nH	ESR 70°C at 10 kHz mΩ	Irms* 70°C at 10 kHz Arms	Rth (HS/Amb) (°C/W)	Packaging Quantity	PART NUMBER	
		T	H	L	S	S1									
V_{OP70} at 70°C = 600 VDC; V_{NDC} at 85°C = 500 VDC; V_{OP105} at 105°C = 350 VDC															
5.6	500	21	12.5	32	27.5	/	65	364	11	12.4	6.8	46	192	C4AQLLU4560M11K	
8	500	24	15	32	27.5	/	65	520	13	9.1	8.6	39	168	C4AQLLU4800M12K	
15	500	31	19	32	27.5	/	65	975	16	5.5	12.6	30	80	C4AQLLU5150M19K	
12	500	24	15	41.5	37.5	10.2	30	360	7	10.7	8.6	33	132	C4AQLLW5120M34K	
16	500	24	19	41.5	37.5	10.2	30	480	8	8.1	10.5	29	88	C4AQLLW5160M33K	
36	500	35	24	42	37.5	20.3	30	1080	9	3.7	17.8	23	60	C4AQLLW5360M36K	
45	500	43	25	42	37.5	20.3	30	1350	9	3.0	21.4	19	48	C4AQLLW5450M38K	
V_{OP70} at 70°C = 800 VDC; V_{NDC} at 85°C = 700 VDC; V_{OP105} at 105°C = 490 VDC															
3.3	700	21	12.5	32	27.5	/	65	214.5	11	16.8	5.8	46	192	C4AQJLU4330M11J	
5	700	24	15	32	27.5	/	65	325	13	11.5	7.7	39	168	C4AQJLU4500M12J	
10	700	31	19	32	27.5	/	65	650	16	6.4	11.7	30	80	C4AQJLU5100M19J	
7.5	700	24	15	41.5	37.5	10.2	30	225	7	13.8	7.6	33	132	C4AQJLW4750M34J	
10	700	24	19	41.5	37.5	10.2	30	300	8	10.4	9.3	29	88	C4AQJLW5100M33J	
22	700	35	24	42	37.5	20.3	30	660	9	4.8	15.5	23	60	C4AQJLW5220M36J	
30	700	43	25	42	37.5	20.3	30	900	9	3.6	19.5	19	48	C4AQJLW5300M38J	
V_{OP70} at 70°C = 960 VDC; V_{NDC} at 85°C = 800 VDC; V_{OP105} at 105°C = 560 VDC															
2.7	800	21	12.5	32	27.5	/	65	175.5	11	18.0	5.6	46	192	C4AQILU4270M11J	
3.8	800	24	15	32	27.5	/	65	247	13	13.2	7.1	39	168	C4AQILU4380M12J	
7.5	800	31	19	32	27.5	/	65	487.5	16	7.3	10.9	30	80	C4AQILU4750M19J	
6	800	24	15	41.5	37.5	10.2	30	180	7	15.1	7.2	33	132	C4AQILW4600M34J	
8	800	24	19	41.5	37.5	10.2	30	240	8	11.4	8.9	29	88	C4AQILW4800M33J	
16	800	35	24	42	37.5	20.3	30	480	9	5.8	14.2	23	60	C4AQILW5160M36J	
22	800	43	25	42	37.5	20.3	30	660	9	4.3	17.9	19	48	C4AQILW5220M38J	
V_{OP70} at 70°C = 1,100 VDC; V_{NDC} at 85°C = 900 VDC; V_{OP105} at 105°C = 650 VDC															
2	900	21	12.5	32	27.5	/	70	140	11	21.6	5.1	46	192	C4AQOLU4200M11J	
3	900	24	15	32	27.5	/	70	210	13	14.8	6.7	39	168	C4AQOLU4300M12J	
6	900	31	19	32	27.5	/	70	420	16	8.1	10.4	30	80	C4AQOLU4600M19J	
4.5	900	24	15	41.5	37.5	10.2	35	157.5	7	18.0	6.6	33	132	C4AQOLW4450M34J	
6.5	900	24	19	41.5	37.5	10.2	35	227.5	8	12.5	8.5	29	88	C4AQOLW4650M33J	
13	900	35	24	42	37.5	20.3	35	455	9	6.3	13.5	23	60	C4AQOLW5130M36J	
18	900	43	25	42	37.5	20.3	35	630	9	4.6	17.2	19	48	C4AQOLW5180M38J	
Cap Value (µF)	VDC	T	H	L	S	S1	dV/dt V/µs	Ipkr Apk	nH	mΩ	Arms	(°C/W)	Packaging Quantity	PART NUMBER	
		Dimensions (mm)									ESR 70°C at 10 kHz	Irms* 70°C at 10 kHz	Rth (HS/Amb)		

(*) I_{rms} value that leads to a ΔT of $\approx 30^\circ C$ in the hot spot $> T_{HS} = T_{AMB} + \Delta T = 70^\circ C + 30^\circ C = 100^\circ C$. Attention: Hot spot at $100^\circ C$ reduced the life time!

Table 2 – Ratings & Part Number Reference for Low Profile Design cont.

Cap Value (µF)	VDC	Dimensions (mm)					dV/dt V/µs	Ipkr Apk	ESL nH	ESR 70°C at 10 kHz mΩ	Irms* 70°C at 10 kHz Arms	Rth (HS/Amb) (°C/W)	Packaging Quantity	PART NUMBER
		T	H	L	S	S1								
V_{OP70} at 70°C = 1,200 VDC; V_{NDC} at 85°C = 1,000 VDC; V_{OP105} at 105°C = 700 VDC														
1.7	1000	21	12.5	32	27.5	/	75	127.5	11	23.0	5.0	46	192	C4AQNLU4170M11J
2.5	1000	24	15	32	27.5	/	75	187.5	13	16.1	6.5	39	168	C4AQNLU4250M12J
4.8	1000	31	19	32	27.5	/	75	360	16	9.0	9.8	30	80	C4AQNLU4480M19J
3.8	1000	24	15	41.5	37.5	10.2	37	140.6	7	19.3	6.4	33	132	C4AQNLU4380M34J
5	1000	24	19	41.5	37.5	10.2	37	185	8	14.7	7.8	29	88	C4AQNLU4500M33J
10	1000	35	24	42	37.5	20.3	37	370	9	7.4	12.5	23	60	C4AQNLU5100M36J
15	1000	43	25	42	37.5	20.3	37	555	9	5.0	16.5	19	48	C4AQNLU5150M38J
V_{OP70} at 70°C = 1,320 VDC; V_{NDC} at 85°C = 1,100 VDC; V_{OP105} at 105°C = 770 VDC														
1.4	1100	21	12.5	32	27.5	/	80	112	11	25.6	4.7	46	192	C4AQLLU4140M11J
2.1	1100	24	15	32	27.5	/	80	168	13	17.5	6.2	39	168	C4AQLLU4210M12J
4	1100	31	19	32	27.5	/	80	320	16	9.8	9.4	30	80	C4AQLLU4400M19J
3	1100	24	15	41.5	37.5	10.2	40	120	7	22.3	6.0	33	132	C4AQLLU4300M34J
4.4	1100	24	19	41.5	37.5	10.2	40	176	8	15.2	7.7	29	88	C4AQLLU4440M33J
8.5	1100	35	24	42	37.5	20.3	40	340	9	8.0	12.1	23	60	C4AQLLU4850M36J
12	1100	43	25	42	37.5	20.3	40	480	9	5.7	15.5	19	48	C4AQLLU5120M38J
V_{OP70} at 70°C = 1,440 VDC; V_{NDC} at 85°C = 1,200 VDC; V_{OP105} at 105°C = 850 VDC														
1.1	1200	21	12.5	32	27.5	/	90	99	11	28.9	4.4	46	192	C4AQPLU4110M11J
1.7	1200	24	15	32	27.5	/	90	153	13	19.1	5.9	39	168	C4AQPLU4170M12J
3.3	1200	31	19	32	27.5	/	90	297	16	10.5	9.1	30	80	C4AQPLU4330M19J
2.5	1200	24	15	41.5	37.5	10.2	45	112.5	7	23.9	5.7	33	132	C4AQPLW4250M34J
3.5	1200	24	19	41.5	37.5	10.2	45	157.5	8	17.1	7.2	29	88	C4AQPLW4350M33J
7.2	1200	35	24	42	37.5	20.3	45	324	9	8.4	11.7	23	60	C4AQPLW4720M36J
10	1200	43	25	42	37.5	20.3	45	450	9	6.1	14.9	19	48	C4AQPLW5100M38J
Cap Value (µF)	VDC	T	H	L	S	S1	dV/dt V/µs	Ipkr Apk	ESL nH	ESR 70°C at 10 kHz mΩ	Irms* 70°C at 10 kHz Arms	Rth (HS/Amb) (°C/W)	Packaging Quantity	PART NUMBER
		Dimensions (mm)												

(*) I_{rms} value that leads to a ΔT of $\approx 30^\circ C$ in the hot spot $> T_{HS} = T_{AMB} + \Delta T = 70^\circ C + 30^\circ C = 100^\circ C$. Attention: Hot spot at $100^\circ C$ reduced the life time!

Soldering Process

The implementation of the RoHS directive has resulted in the selection of SnAuCu (SAC) alloys, or SnCu alloys, as the primary solder material. This has increased the liquidus temperature from 183°C for a SnPb eutectic alloy to 217 – 221°C for new alloys. As a result, the heat stress to the components, even in wave soldering, has increased considerably due to higher pre-heat and wave temperatures. Polypropylene capacitors are especially sensitive to heat (the melting point of polypropylene is 160 – 170°C). Wave soldering can be destructive, especially for mechanically small polypropylene capacitors (with lead spacing of 5 – 15 mm), and great care must be taken during soldering. The recommended solder profiles from KEMET should be used. Contact KEMET with any questions. In general, the wave soldering curve from IEC Publication 61760-1 Edition 2 serves as a solid guideline for successful soldering. See Figure 1.

Reflow soldering is not recommended for through-hole film capacitors. Exposing capacitors to a soldering profile in excess of the recommended limits may result in degradation or permanent damage to the capacitors.

Do not place the polypropylene capacitor through an adhesive curing oven to cure resin for surface mount components. Insert through-hole parts after curing the surface mount parts. Contact KEMET to discuss the actual temperature profile in the oven, if through-hole components must pass through the adhesive curing process. A maximum two soldering cycles is recommended. Allow time for the capacitor surface temperature to return to normal before the second soldering cycle.

Manual Soldering Recommendations

Following is the recommendation for manual soldering with a soldering iron.

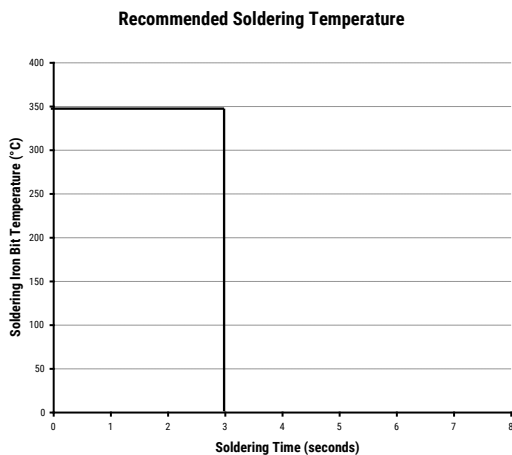

The soldering iron tip temperature should be set at 350°C (+10°C maximum) with the soldering duration not to exceed more than 3 seconds.

Wave Soldering Recommendations

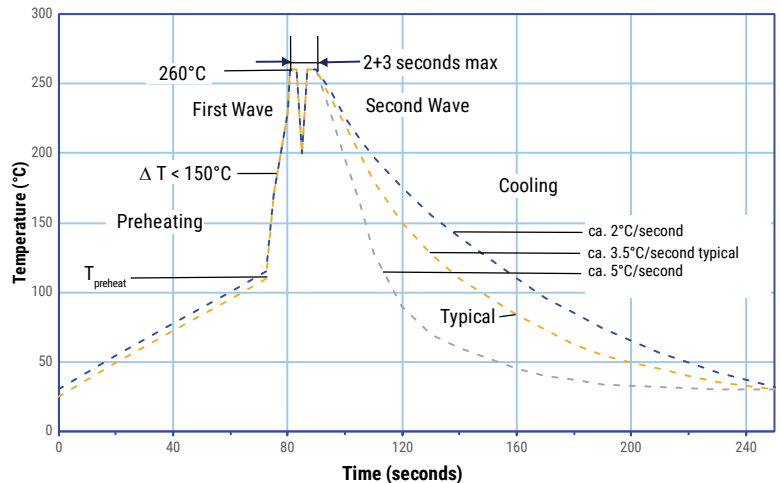

Soldering Process cont.

Wave Soldering Recommendations cont.

1. The tables indicates the maximum set-up temperature of the soldering process

Dielectric Film Material	Maximum Preheat Temperature		Maximum Peak Soldering Temperature	
	Capacitor Pitch ≤ 15 mm	Capacitor Pitch > 15 mm	Capacitor Pitch ≤ 15 mm	Capacitor Pitch > 15 mm
Polyester	130°C	130°C	270°C	270°C
Polypropylene	110°C	130°C	260°C	270°C
Paper	130°C	140°C	270°C	270°C
Polyphenylene Sulphide	150°C	160°C	270°C	270°C

2. The maximum temperature measured inside the capacitor: set the temperature so that inside the element the maximum temperature is below the limit.

Dielectric Film Material	Maximum Temperature Measured Inside the Element
Polyester	160°C
Polypropylene	110°C
Paper	160°C
Polyphenylene Sulphide	160°C

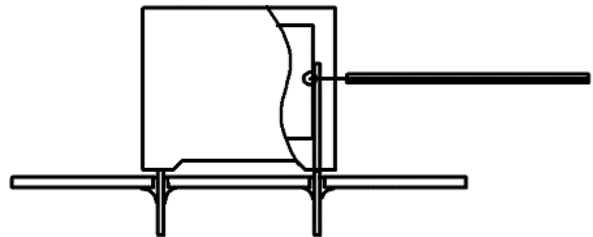

Temperature monitored inside the capacitor.

Selective Soldering Recommendations

Selective dip soldering is a variation of reflow soldering. In this method, the printed circuit board with through-hole components to be soldered is pre-heated and transported over the solder bath, as in normal flow soldering, without touching the solder. When the board is over the bath, it is stopped. Pre-designed solder pots are lifted from the bath with molten solder, only at the places of the selected components, and pressed against the lower surface of the board to solder the components.

The temperature profile for selective soldering is similar to the double wave flow soldering outlined in this document. However, instead of two baths, there is only one with a time from 3 – 10 seconds. In selective soldering, the risk of overheating is greater than in double wave flow soldering, and great care must be taken so that the parts do not overheat.

Mounting

Resistance to Vibration and Mechanical Shock

AEC-Q200 Mechanical Stress Tests:

Mechanical Shock	MIL-SDT-202 Method 213	Test condition C Peak value 100 g, duration 6 ms, half-sine-wave (see MIL-HDBK for details)
Vibration	MIL-SDT-202 Method 204	5 g for 20 minutes, 12 cycles each of 3 orientations Use 8"X5" PCB, .031" thick. 7 secure points on one 8" side and 2 secure points at corners of opposite sides. Parts mounted within 2" from any secure point. Test from 10 – 2,000 Hz.

The capacitors are designed for PCB mounting.
 The stand-off pipes must be in good contact with the printed circuit board.
 The capacitor body has to be properly fixed (e.g. clamped or glued).

Construction

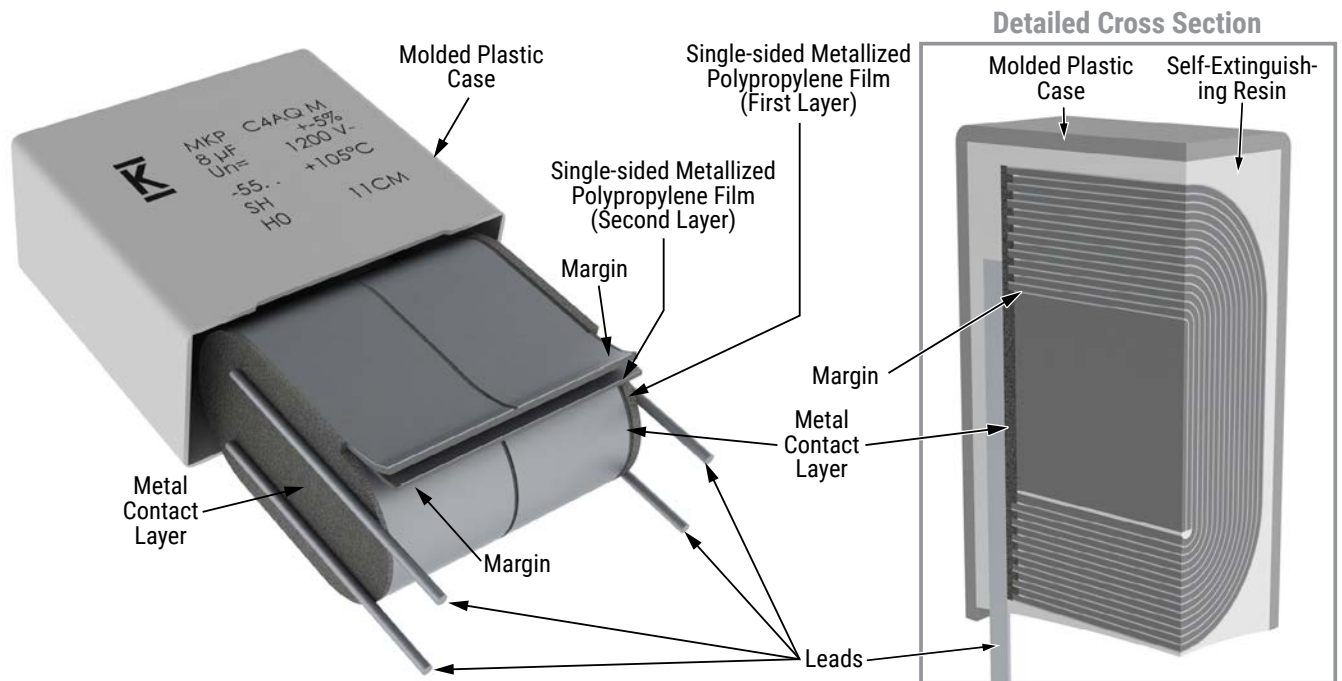

Construction cont.

Low Profile Version:

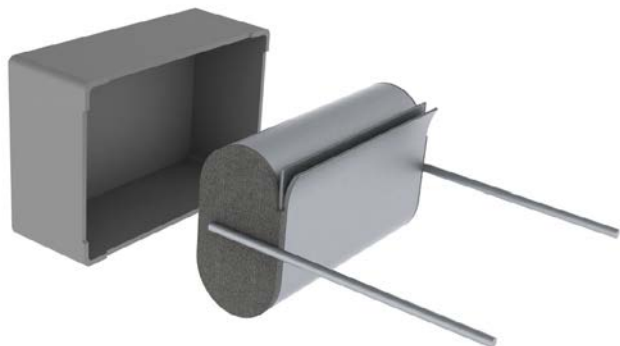

Winding Scheme:

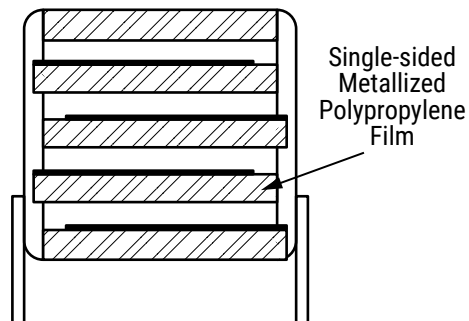

Marking

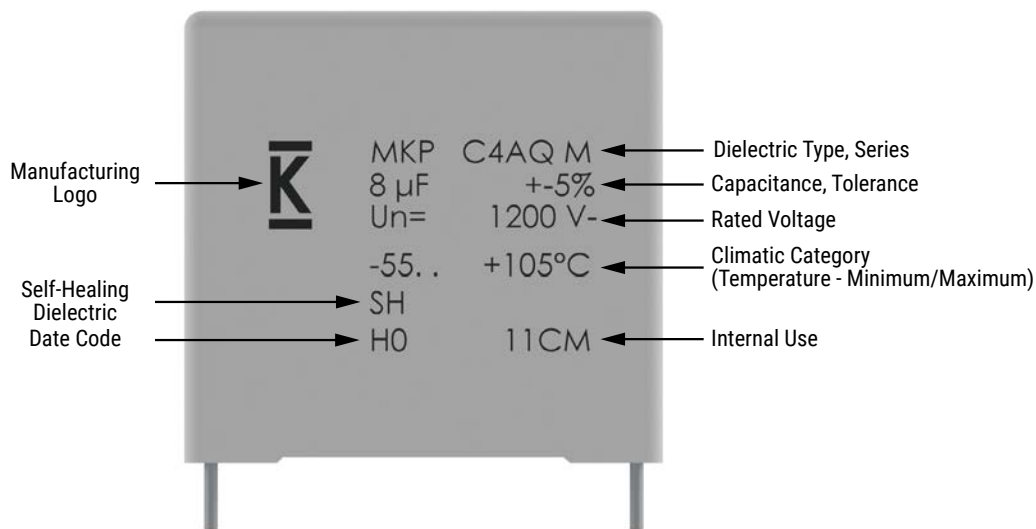

Manufacturing Date Code (IEC-60062)									
Year	Code	Year	Code	Year	Code	Month	Code	Month	Code
2010	A	2017	J	2024	S	January	1	July	7
2011	B	2018	K	2025	T	February	2	August	8
2012	C	2019	L	2026	U	March	3	September	9
2013	D	2020	M	2027	V	April	4	October	0
2014	E	2021	N	2028	W	May	5	November	N
2015	F	2022	P	2029	X	June	6	December	D
2016	H	2023	R	2030	A				

KEMET Electronics Corporation Sales Offices

For a complete list of our global sales offices, please visit www.kemet.com/sales.

Disclaimer

All product specifications, statements, information and data (collectively, the "Information") in this datasheet are subject to change. The customer is responsible for checking and verifying the extent to which the Information contained in this publication is applicable to an order at the time the order is placed. All Information given herein is believed to be accurate and reliable, but it is presented without guarantee, warranty, or responsibility of any kind, expressed or implied.

Statements of suitability for certain applications are based on KEMET Electronics Corporation's ("KEMET") knowledge of typical operating conditions for such applications, but are not intended to constitute – and KEMET specifically disclaims – any warranty concerning suitability for a specific customer application or use. The Information is intended for use only by customers who have the requisite experience and capability to determine the correct products for their application. Any technical advice inferred from this Information or otherwise provided by KEMET with reference to the use of KEMET's products is given gratis, and KEMET assumes no obligation or liability for the advice given or results obtained.

Although KEMET designs and manufactures its products to the most stringent quality and safety standards, given the current state of the art, isolated component failures may still occur. Accordingly, customer applications which require a high degree of reliability or safety should employ suitable designs or other safeguards (such as installation of protective circuitry or redundancies) in order to ensure that the failure of an electrical component does not result in a risk of personal injury or property damage.

Although all product-related warnings, cautions and notes must be observed, the customer should not assume that all safety measures are indicated or that other measures may not be required.

KEMET is a registered trademark of KEMET Electronics Corporation.